

ROVER BOOST



Maximum Power-Point Tracking Boost Charge Controller

36V/48V | 10A

Version 1.0



Important Safety Instructions

Please save these instructions.

This manual contains important safety, installation, and operating instructions for the charge controller. The following symbols are used throughout the manual to indicate potentially dangerous conditions or important safety information.

WARNING

Indicates a potentially dangerous condition. Use extreme caution when performing this task

CAUTION

Indicates a critical procedure for safe and proper operation of the controller

NOTE

Indicates a procedure or function that is important to the safe and proper operation of the controller

General Safety Information

- Refer installation and servicing to qualified service personnel. High voltage is present inside unit. Incorrect installation or use may result in risk of electric shock or fire. No user serviceable parts in this unit.
- Remove all sources of power, photovoltaic and battery before servicing or installing.
- Do NOT allow water to enter the charge controller, irreversible damage may occur.
- Make sure connections going into and from the controller are tight and secure.

Battery Safety Information

- **WARNING - EXPLOSION HAZARD**
 - Working in the vicinity of lead-acid batteries is dangerous. Batteries produce explosive gasses during normal battery operation.
 - To reduce risk of battery explosion, follow these instructions and those published by battery manufacturer and manufacturer of any equipment you intend to use in vicinity of battery.
- NEVER charge a frozen battery
- Do not short the battery; do not let the positive and negative terminals of the battery contact each other.
- Overcharging and excessive gas precipitation may damage battery plates and activate material shedding on them. Please review battery charging specifications before connecting your battery.

Charger Location and Installation Information

- The controller employs components that tend to produce arcs or sparks. NEVER install in battery compartment or in the presence of explosive gases.
- Protect all wiring from physical damage, vibration, and excessive heat.
- Do NOT expose the controller to rain or snow
- Ensure all terminating connections are clean and tight to prevent arcing and overheating.

Table of Contents

General Information	03
Product Description	03
Product Overview	04
Identification of Parts	04
Dimensions	06
Included Components	07
Optional Components	07
Installation	08
Mounting Recommendations	08
Recommended Gauge and Ring Terminal Sizes	09
Wiring	10
Battery Wiring	10
Solar Panel Wiring	13
Grounding	15
Connecting the Temperature Sensor (RTSCC)	16
Connecting the Battery Voltage Sensor (RVSCC)	16
Operation	17
Auto Recognition and Toggle	17
Set the Battery Type	18
LED Indicators	18
MPPT Technology	19
Communication Ports	22
Host Mode Communication	23
Connecting to a 48V Smart LFP Battery	23
Paralleling 2 Rover Boosts w/ a 48V Smart Battery	24
Paralleling 2 Rover Boosts w/ Non-Lithium	26
Electronic Protections and Troubleshooting	27
Maintenance	31
Technical Specifications	32
Battery Charging Parameters	33

General Information

■ Product Description

The all-new Rover Boost controller is a 10Amp Maximum Power Point Tracking (MPPT) charge controller engineered to charge a 36V or 48V battery bank from voltage typically found in only 1-2, 36-cell solar modules. Featuring 4-stage battery charging (Bulk, Boost, Float, and Equalization), the Rover Boost is pre-set to be compatible with AGM, Gel, Flooded, and Lithium batteries, and even includes custom battery settings. The Rover Boost is packed with numerous battery bank, controller, and solar electronic protections for peace of mind and an optimized system you can trust.

Key Features

- 36V/48V Automatic System Recognition of Lead Acid Batteries.
- Self-adaptable to a wide solar panel input voltage for appropriate battery charging.
- Multi-Function LEDs displaying system information and identifying any errors.
- Advanced MPPT Technology with minimum 99% tracking efficiency and above 90% charge conversion efficiency.
- 4 Pre-set battery charge profiles include AGM, Gel, Flooded, and Lithium as well as a custom mode for a wide variety of applications.
- Multiple battery bank, controller, and solar electronic protections including over-charge protection, reverse polarity protection, and more.
- RS485 communication port for monitoring using the Bluetooth module and Renogy DC Home App.
- CAN communication port synchronizes the battery information for smart charging.

Product Overview

■ Identification of Parts

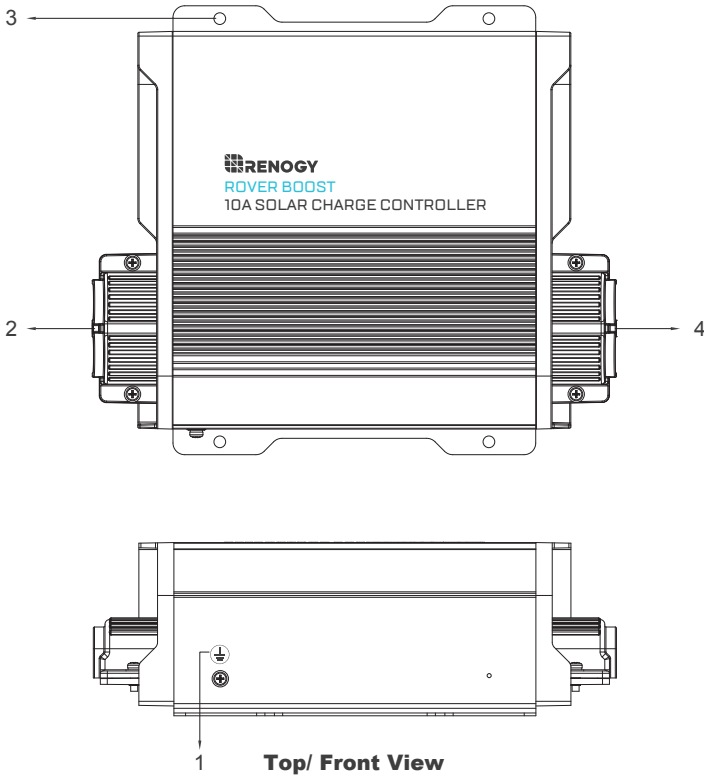

1. Grounding Lug
2. Output Port: 36V or 48V Battery Connections
3. Mounting Holes (4)
4. Input Port: Solar Panel input connections, 15~40V (VOC)

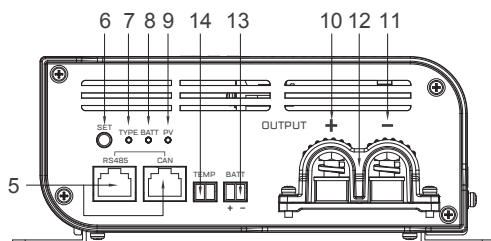

Left View

- | | |
|--|---|
| 5. RS485 / CAN Communication Ports | 10. 36/48V Positive Battery Output Terminal |
| 6. Setting Button
(Battery Type, CAN Host Mode) | 11. 36/48V Negative Battery Output Terminal |
| 7. Battery Type LED Indicator | 12. Removable Battery Output Cable Housing |
| 8. Battery Status LED Indicator | 13. Battery Voltage Sensor Port
(Polarity Sensitive, Optional) |
| 9. PV Status LED Indicator | 14. Battery Temperature Sensor Port (Optional) |

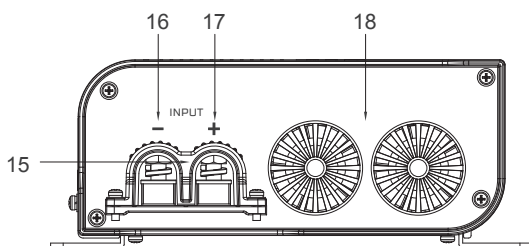

Right View

- | | |
|--------------------------------------|--------------------------------|
| 15. Removable PV Input Cable Housing | 17. Positive PV Input Terminal |
| 16. Negative PV Input Terminal | 18. Cooling Fans |

■ Dimensions

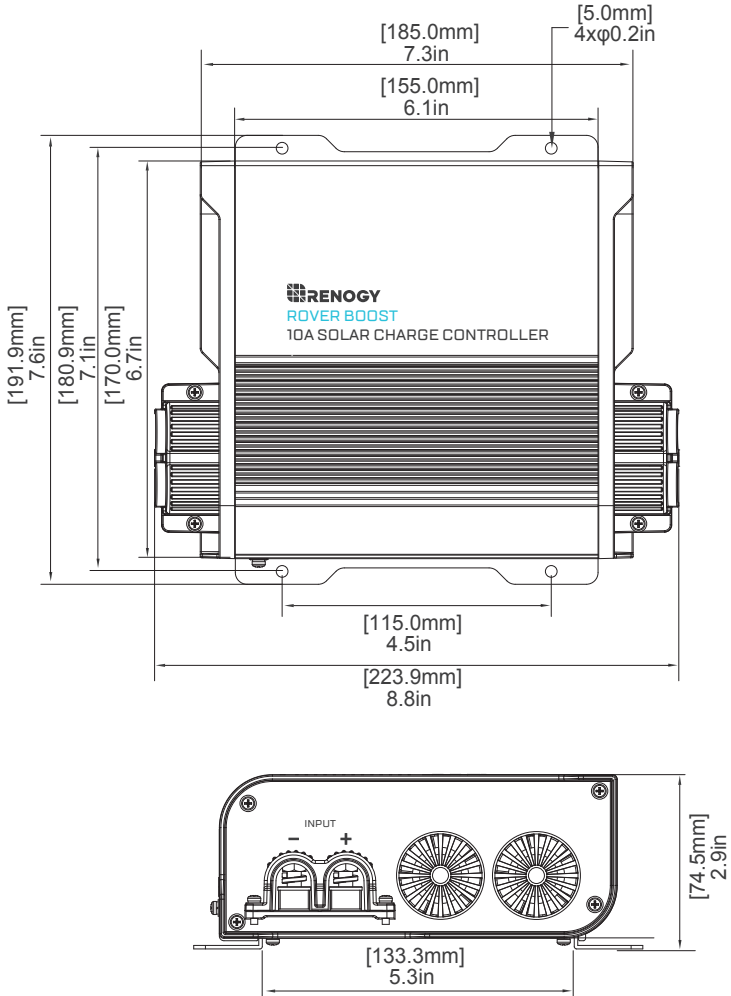

NOTE

The dimensions have a $\pm 0.5\text{mm}$ tolerance.

■ Included Components

Mounting Screws for the Input/output Terminals

The Rover boost terminals are secured not only by tightening the cable entry hatch, but also by utilizing the removable cable housing to secure the incoming and outgoing connections.

■ Optional Components



Renogy BT-2 Bluetooth Module (Model: RCM-BT2)

The RCM-BT2 is a great addition to any Renogy charge controller with an RS485 port. Pair the controller to the Renogy DC Home App to monitor your system using a smart device like a cell phone or tablet. Set custom charging parameters using User Mode and monitor your system in real time.



Remote Temperature Sensor (Model: RTSCC)

The RTSCC measures the temperature at the battery bank and uses this data for very accurate temperature compensation. The sensor is supplied with a 9.8 ft cable length that connects to the charge controller. Simply connect the cable to the appropriate slot using the green connector and place the sensor on top or on the side of the battery bank and it will immediately start working.

NOTE

Do not use this sensor with Lithium batteries.



Renogy Voltage Sensor (Model: RVSCC)

The RVSCC provides users with more accurate battery charging giving you peace of mind that the charge controller is operating as effectively as it should. On certain applications with long line runs, there can be a difference between the voltage measured at an MPPT solar charger's terminals and that measured at the battery terminals. The RVSCC is the perfect solution by providing a more accurate battery voltage to the controller and allowing it to adjust the charging stage more precisely resulting in overall extension of your battery life.

Installation

WARNING

Connect the battery terminal wires to the Charge controller **FIRST** then connect the solar panels to the charge controller **SECOND**. Connecting panels before the battery may result in irreversible damage.

Never install the controller in a sealed enclosure with flooded batteries as gas may accumulate and there is a risk of explosion.

CAUTION

Do not over-tighten the terminals. This could potentially break mounting components rendering the controller useless.

CAUTION

Connections should be made according to Article 690 of the National Electrical Code (NFPA 70) or the standards in force at the installation location.

■ Mounting Recommendations

- 1. Choose Mounting Location**—place the controller on a vertical surface protected from direct sunlight, high temperatures, and water. Make sure there is good ventilation.
- 2. Check for Clearance**—verify that there is sufficient room to run wires, as well as clearance above and below the controller for ventilation. The clearance should be at least 6 inches (154mm).
- 3. Mark Holes**
- 4. Drill Holes**
- 5. Secure the charge controller.**

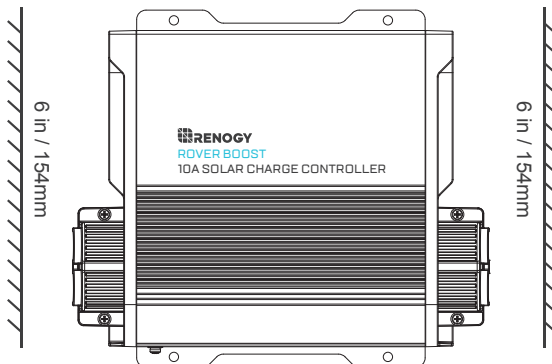

Recommended Gauge and Ring Terminal Sizes

The Rover Boost accepts ring terminals or lugs. Due to the terminal housing, ring terminals must comply with the following instructions

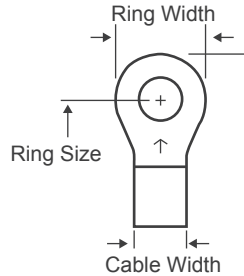

Ring Width	Cable Width	Ring Size Recommended
< 19mm < 3/4"	< 14.5mm < 9/16"	6mm 1/4"

Specification	Recommended AWG	Rated Amps	Recommended Fusing
Battery Wiring	12 AWG	10A	15A-20A

The following recommendation is based off 3% maximum voltage loss. The recommended wire sizing may not cover all unit applications that may exist.

Specification	Recommended AWG		
Battery Output Charging Amps	0 ~ 10 ft / 0 ~ 3m	11 ~ 20 ft / 3 ~ 6m	21 ~ 30 ft / 6 ~ 9m
10A	14 AWG	12 ~ 10 AWG	10 AWG

Specification	Recommended AWG		
PV Input Charging Amps	0 ~ 10 ft / 0 ~ 3m	11 ~ 20 ft / 3 ~ 6m	21 ~ 30 ft / 6 ~ 9m
100W ~ 5A	16AWG	16 ~ 14AWG	14 ~ 12AWG
200W ~ 10A	16 ~ 14AWG	14 ~ 12AWG	10AWG
300W ~ 15A	14 ~ 12AWG	12 ~ 10 AWG	10 ~ 8AWG
400W ~ 20A	14 ~ 12AWG	10 ~ 8AWG	6AWG
500W ~ 25A*	12 ~ 10 AWG	8 ~ 6AWG	6AWG
600W ~ 30A*	10AWG	8 ~ 6AWG	6 ~ 4AWG

NOTE

The Rated Max PV Input Power is 500W (36V) or 650W (48V)

Larger wire sizes will improve boost performance whereas smaller wire sizes will reduce boost performance. When considering wiring, fuse, and connection options think big and short as larger heavier components and shorter wire lengths offer less resistance and voltage drop.

Wiring

WARNING

The Rover Boost is only suitable for 36V or 48V battery banks only. Not abiding by these battery voltages may lead to irreversible damage to your controller or system

Be careful with the positive and negative poles of battery bank; reversing them or having them make contact may cause irreversible damage not covered by warranty.

Battery Wiring

NOTE

The positive or negative battery cable should be protected by a fast-acting fuse or circuit breaker of 15A-20A, rated for the maximum battery voltage and connected close to the battery terminal or power distribution block. This fuse will protect the wiring in the event of a short circuit or controller damage.

A small spark while connecting the battery to the controller is ok. However, make sure to have appropriate wiring at the input and output.

NOTE

The M3 screws have a recommended torque of 0.5~0.8 Nm / 0.4~0.6 lb. ft. The M6 screws have a recommended torque 4.1~5.0Nm / 3~3.7 lb. ft.

WARNING

The Rover Boost has reverse polarity protection for battery connections and extra precautions must be taken when connecting Lithium Batteries. Do not have a PV Source connected until the correct battery setting has been selected.

- WARNING - EXPLOSION HAZARD

Working in the vicinity of lead-acid batteries is dangerous. Batteries produce explosive gasses during normal battery operation.

1. Locate the OUTPUT side. Expose the positive and negative battery output terminals by unscrewing the M3 screws holding down the removable battery output cable housing.

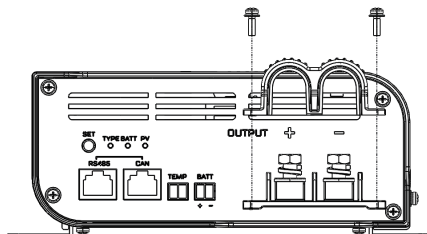

-
2. Unscrew the negative M6 terminal stud, then place the negative Battery ring terminal onto the negative port and screw the M6 terminal stud and washers together. Repeat the same for the positive M6 terminal stud and positive Battery ring terminal.

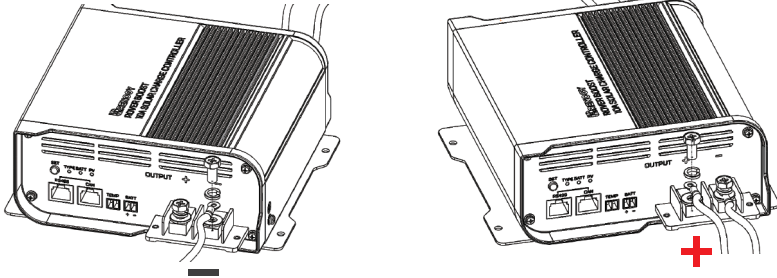

NOTE

The M6 screws have a recommended torque 4.1~5.0 N-m / 3~3.7 lb. ft.

3. When finished, place the removable battery output cable housing back over your connections. Make sure to not over-tighten the M3 screws.

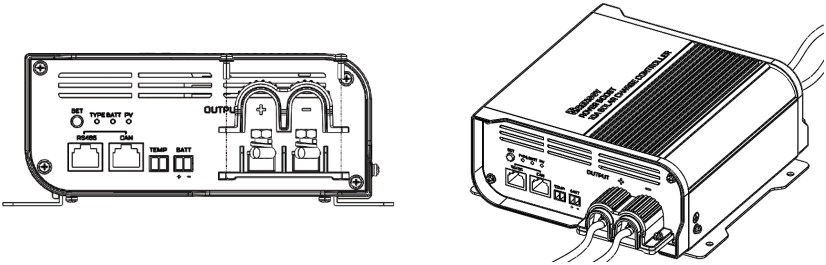

NOTE

The M3 screws have a recommended torque of 0.5~0.8 N-m / 0.4~0.6 lb. ft.

To ensure maximum safety, it is important to use correct wiring for either 36V or 48V battery banks. Series connections are when batteries of the same size and type are combined, and their voltages add up. The batteries Amp-Hour (Ah) Rating, however, remains the same. Examples are below:

48V 100Ah Wiring

Assuming each battery is 12V 100Ah battery bank, you will combine 4 x 12V batteries in series to achieve a 48V 100Ah battery bank. In series connections, the 12V voltages add up to 48V, while the 100Ah Rating remains the same.

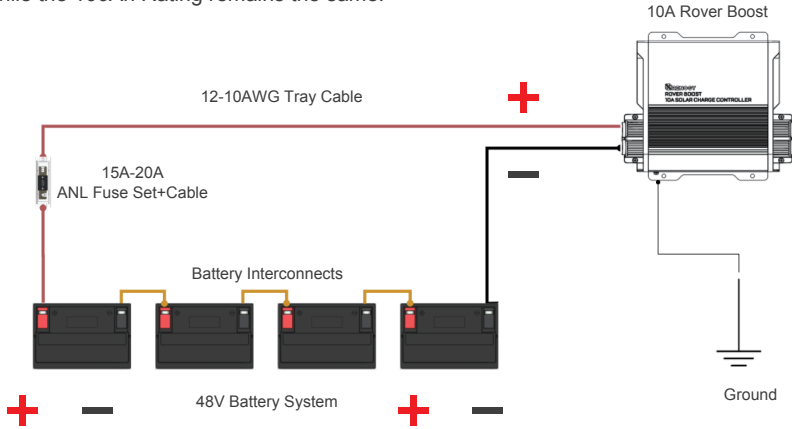

36V 100Ah Wiring

Assuming each battery is 12V 100Ah battery bank, you will combine 3 x 12V batteries in series to achieve a 36V 100Ah battery bank. In series connections, the 12V voltages add up to 36V, while the 100Ah Rating remains the same.

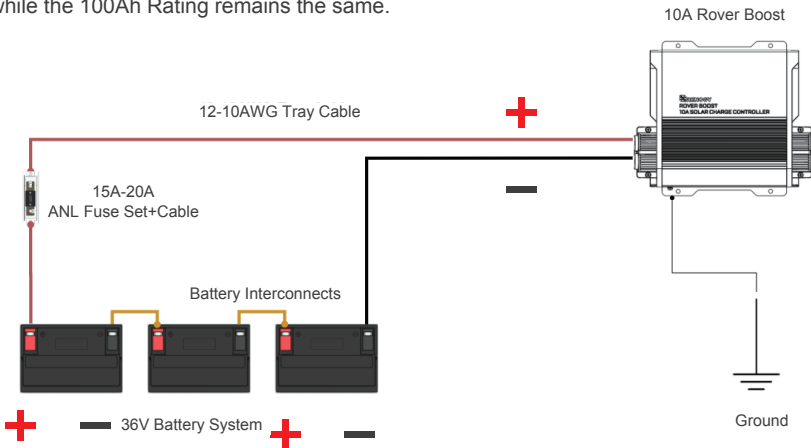

NOTE

The M3 screws have a recommended torque of 0.5~0.8 N-m / 0.4~0.6 lb. ft.
The M6 screws have a recommended torque 4.1~5.0 N-m / 3~3.7 lb. ft.

Solar Panel Wiring

The Rover Boost is designed to automatically utilize MPPT technology to boost wasted power into usable charge current.

NOTE

Ring terminals are recommended for the input and output connections of the Rover Boost.

WARNING

Failure to abide by the chart may result in damage to your system or system components. Please pay close attention to your solar panel specifications when connecting them to the controller.

WARNING

Not compatible with 72 cell PV Modules.

Typical Modules

The following represents typical modules and their properties. Depending on how many solar panels you are combining, appropriate series or parallel connections will be needed to achieve the maximum power of the charge controller. Series connections will connect positive to negative and add up the voltage, while the current remains the same. The controller will utilize excess voltage and convert it into useable current. Parallel connections will connect positive to positive on one side and negative to negative on the other side resulting in the voltage remaining the same while the current adds up, thus increasing your net input current power.

Solar Module	Solar Vmp	Solar Voc	Rated Power
36 cells	19.5V	23.9V	50W-200W
60 cells	32.7V	39.8V	300W-350W

NOTE

This chart represents typical values found with the respective cells on the solar modules. Actual values might differ depending on the manufacturer.

PV Requirements

WARNING

The Rover Boost may be permanently damaged if exceeding the Max PV Power w/ Power Limiting.

The following chart represents the operating Voc range for panels respective to the battery bank voltage. This information is found in the technical specifications for panels or in the solar panel sticker. The Rover Boost features a power limiting clipping function, where the power is limited within a specified range, and therefore allows the battery to charge at correct parameters despite the oversized input power.

System Voltage	Range	Rated Max PV Power
36 V	15 ~ 25 VDC	500W
48 V	15 ~ 40 VDC	650W

NOTE If the VOC is greater than 45V, charging disconnects; When the VOC is less than 40V, then it resumes charging.

CAUTION Exceeding the Rated Max Power will put the controller in Power Limiting Protection Mode up to 600W/36V or 800W/48V. Afterwards the unit will shut down.

1. Locate the INPUT side. Expose the positive and negative PV input terminals by unscrewing the M3 screws holding down the removable PV input cable housing.

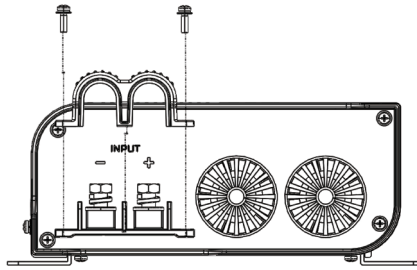

2. Unscrew the negative M6 terminal stud, then place the negative PV ring terminal onto the negative port and screw the M6 terminal stud and washers together. Repeat the same for the positive M6 terminal stud and positive PV ring terminal.

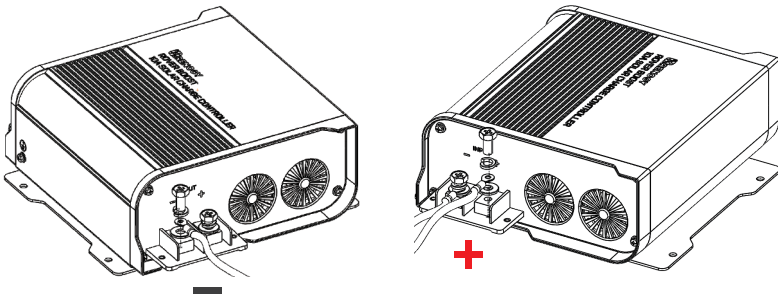

NOTE **The M6** screws have a recommended torque 4.1~5.0 N·m / 3~3.7 lb. ft.

- When finished, place the removable PV input cable housing back over your connections. Make sure to not over-tighten the M3 screws.

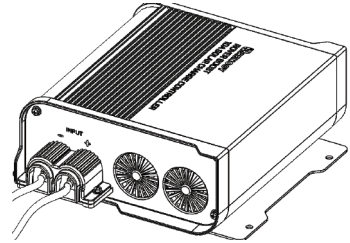
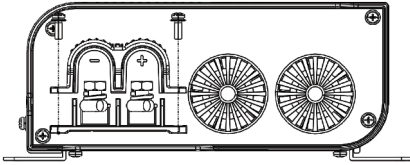

NOTE

The M3 screws have a recommended torque of 0.5~0.8 N-m / 0.4~0.6 lbf. ft.

Typical Setup

200W System, 48V System

A typical setup is demonstrated utilizing 2 x 100W panels in parallel where all the positive connectors connect, and all the negative connections connect before they are connected at the input of the Rover Boost. Other items include: a set of MC4 branch connectors, an inline MC4 fuse, an Adapter kit, the 10A Rover Boost, a set of tray cables, an ANL Fuse set and cable, battery interconnects, and a 48V battery bank system.

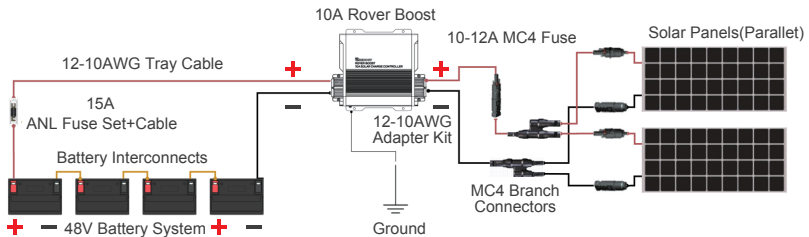

Grounding

CAUTION

Do NOT ground PV input and Battery output individually, use the controller ground lug.

Grounding is not necessary for the operation and is at user's discretion. If grounding, do not ground the PV input and Battery output connections together. Instead, Locate the M3 ground screw on the front of the Rover Boost. Unscrew the terminal, place a M3 ring connector and ground the system to earth ground.

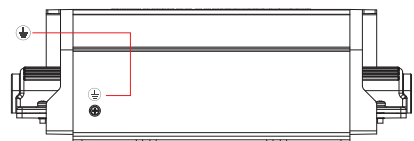

NOTE

The M3 screws have a recommended torque of 0.5~0.8 N-m / 0.4~0.6 lbf. ft.

■ Connecting the Temperature Sensor (Model: RTSCC)

The RTSCC will include the 2-pin green housing connector. Simply connect the 2-pin connector to the TEMP port on the OUTPUT side of the Rover Boost.

NOTE

Separate purchase required.

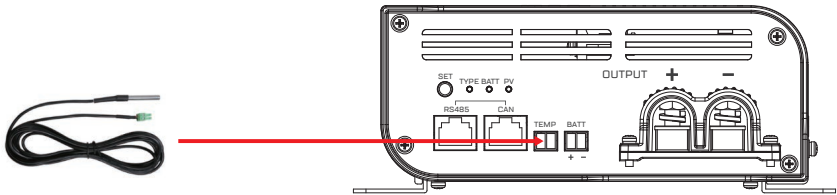

■ Connecting the Battery Voltage Sensor (Model: RVSCC)

CAUTION

The RVSCC is polarity sensitive and you must connect it to the correct positive (+, left pin) and the correct negative (-, right pin) battery terminals as well as match the polarity written on the BATT port on the Rover Boost (+, -).

The RVSCC will include the 2-pin green housing connector on one end as well as positive and negative ring connectors on the other end. First connect the negative and positive ring terminals to your battery bank. Make sure it is the correct polarity. Next, simply connect the 2-pin connector to the BATT port on the OUTPUT side of the Rover Boost.

NOTE

Separate purchase required.

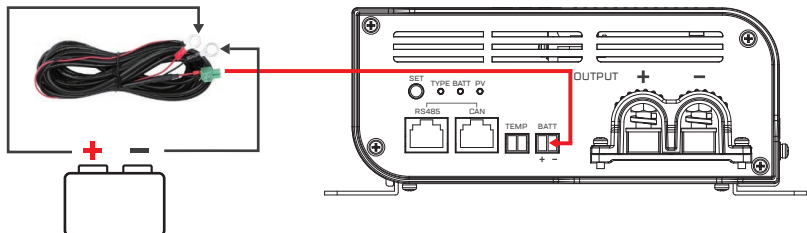

Operation

The Rover Boost is relatively simple to operate. You will need to set your battery type using the SET button and then the controller can take care of the rest. The LED Indicators and SET button are found on the OUTPUT side of the Rover Boost.

CAUTION

Set the correct battery type before the first time use

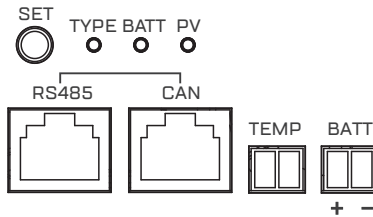

Auto Recognition and Toggle

The Rover Boost requires that the battery bank be 36V or 48V to operate. It features automatic battery recognition for deep cycle lead acid and VRLA batteries. It is always good practice to double check the recognized battery matches the intended voltage of the battery bank. Lithium batteries will need to be set manually when charging 36V / 48V systems. Auto Recognition will behave in the fashion indicated below:

Auto Detect System Voltage	Battery Voltage Range
36 V	< 42V
48 V	> 42V

NOTE







Auto Detection is intended for 36V / 48V non-lithium batteries.

A fully charged 36V non-lithium battery that is connected for the first time may have a voltage that exceeds the 42V threshold. This may include situations where the controller is restarted or disconnected and then reconnected. Therefore, the Rover Boost will flash the TYPE LED to toggle the system voltage in the fashion indicated below:

System Voltage	Battery Voltage Range	Toggle
36 V	> 42V	Long press (5s) the SET button to toggle 36V
48 V		Short press the SET button to toggle 48V

■ Set the Battery Type

AGM (Green) is the default battery type for the Rover Boost. To change or set the battery type, long press the SET button for approximately 8 seconds. The Type Indicator will flash a color depending on the battery type indicated below. Tap the SET button to change between battery types until the appropriate TYPE color is flashing. To set the battery type, long press the SET button again and the battery type will be set. Alternatively, you may leave the battery type flashing and after 15 seconds of inactivity, the battery type flashing will be set as the battery type.

TYPE LED	Color	Battery Type
	Yellow	Gel
	Green	AGM
	Red	Flooded
	Blue	36V Lithium-iron Phosphate (LFP) – 12 Strings
	Purple	48V Lithium-iron Phosphate (LFP) – 15 Strings
	White	User (48V Lithium-iron Phosphate (LFP) – 16 Strings)

NOTE







When a non-lithium battery is connected for the first time, and the battery voltage is detected to be greater than 42V, the TYPE LED will flash, short press the button to enter 48V, long press to enter 36V.

By Default, User mode will operate as a 48V Lithium-iron Phosphate (LFP) – 16 Strings battery charging profile. User mode can be customized via software app development utilizing the BT-2 Bluetooth Module (RCM-BT2) and Renogy DC Home App.







■ LED Indicators

The Rover Boost LED indicators work to provide battery type information, battery status information, and solar charging information.

PV LED Indicator

PV LED	Color	Behavior	Charge State
	Green	Always on Bright, always on	MPPT Bulk Charging
	Green	Slow Flashing ON 1 second, OFF 1 second, cycle is 2 seconds	Boost Stage
	Green	Single Flash ON 0.1 second, OFF 1.9 seconds, cycle is 2 seconds	Float Stage
	Green	Quick Flashing ON 0.1 second, OFF 0.1 second, cycle is 0.2 seconds	Equalization Charge
	Green	Double Flashing ON 0.1 seconds, OFF 0.1 second, ON 0.1 seconds OFF 1.7 seconds	Lithium Activation or Power Limiting
	---	OFF	PV is not charging or not detected

Battery LED Indicator

BATT LED	Color	Behavior	Charge State
	Green	Always on Bright, always on	Battery is fully charged
	Yellow	Always on Bright, always on	Battery voltage is normal
	Red	Always on Bright, always on	Battery undervoltage warning
	Red	Slow Flashing ON 1 second, OFF 1 second, cycle is 2 seconds	Battery over discharged disconnected
	Red	Quick Flashing ON 0.1 second, OFF 0.1 second, cycle is 0.2 seconds	Battery Overvoltage or Over temperature
	---	OFF	Battery is not detected

■ MPPT Technology

The MPPT Charge Controller utilizes Maximum Power Point Tracking Technology to extract maximum power from the solar module(s). The tracking algorithm is fully automatic and does not require user adjustment. MPPT technology will track the array's maximum power point voltage (V_{mp}) as it varies with weather conditions, ensuring that the maximum power is harvested from the array throughout the course of the day.

Voltage Boost

The Rover Boost will “boost” up the voltage in the solar system. The power generated in the solar panels is the same power that is transmitted into the battery bank. Power is the product of Voltage (V) x Amperage (A).

Therefore, assuming 100% efficiency:

$$\begin{aligned} \text{Power In} &= \text{Power Out} \\ \text{Volts In} * \text{Amps In} &= \text{Volts out} * \text{Amps out} \end{aligned}$$

PV Array voltage and temperature have a direct influence on the voltage boost performance. A PV module at constant solar intensity will vary the power output depending on temperature changes. Therefore, it is important to note that a cooler PV array can produce a higher voltage, and therefore more power, than a hot PV array. When the PV voltage is enough for the MPPT operating range then a constant power output is delivered to the battery.

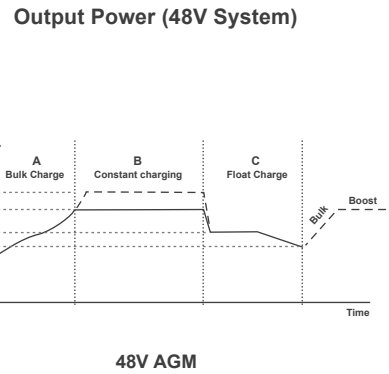
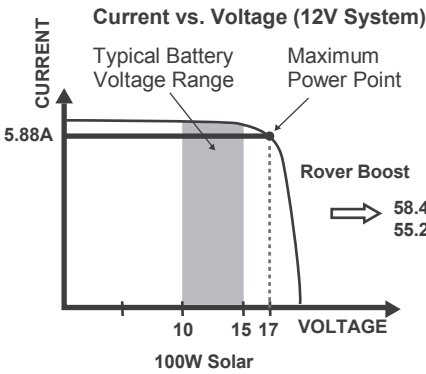

In the chart above, the maximum power point at which the PV module delivers maximum power (17V*5.8A) is observed, and the Rover Boost increases the voltage to Charge an AGM 48V battery bank. The Rover Boost will continually recalculate the maximum power voltage as operating conditions change and extract this power. The input power feeds a switching type power converter which increases the voltage to the battery.

Limiting Effectiveness

Temperature is a huge enemy of solar modules. As the environmental temperature increases, the operating voltage (Vmp) is reduced and limits the power generation of the solar module. Despite the effectiveness of MPPT technology, the charging algorithm will possibly not have much to work with and therefore there is an inevitable decrease in performance. This is why it is preferred to have PV modules be in cooler ambient temperatures for the greatest boost.

This is why it is preferred to have PV modules be in cooler ambient temperatures for the greatest voltage boost.

Four Charging Stages

The MPPT charge controller has a 4-stage battery charging algorithm for a rapid, efficient, and safe battery charging. They include: Bulk Charge, Boost Charge, Float Charge, and Equalization.

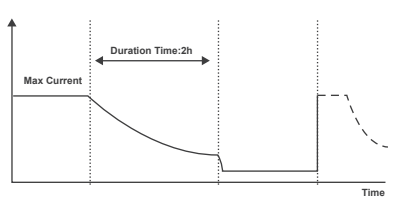
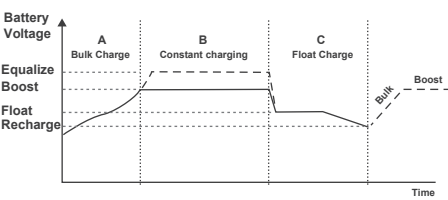

Bulk Charge: This algorithm is used for day to day charging. It uses 100% of available solar power to recharge the battery and is equivalent to constant current. In this stage the battery voltage has not yet reached constant voltage (Equalize or Boost), the controller operates in constant current mode, delivering its maximum current to the batteries (MPPT Charging) .

Constant Charging: When the battery reaches the constant voltage set point, the controller will start to operate in constant charging mode, where it is no longer MPPT charging. The current will drop gradually. This has two stages, equalize and boost and they are not carried out constantly in a full charge process to avoid too much gas precipitation or overheating of the battery.

- **Boost Charge:** Boost stage maintains a charge for 2 hours by default. User Mode can adjust the constant time and preset value of boost per their demand.

Float Charge: After the constant voltage stage, the controller will reduce the battery voltage to a float voltage set point. Once the battery is fully charged, there will be no more chemical reactions and all the charge current would turn into heat or gas. Because of this, The charge controller will reduce the voltage charge to smaller quantity, while lightly charging the battery. The purpose for this is to offset the power consumption while maintaining a full battery storage capacity. In the event that a load drawn from the battery exceeds the charge current, the controller will no longer be able to maintain the battery to a Float set point and the controller will end the float charge stage and refer back to bulk charging.

⚠ **Equalization:** Is carried out every 30 days. It is intentional overcharging of the battery for a controlled period of time. Certain types of batteries benefit from periodic equalizing charge, which can stir the electrolyte, balance battery voltage and complete chemical reaction. Equalizing charge increases the battery voltage, higher than the standard complement voltage, which gasifies the battery electrolyte.

WARNING

Once equalization is active in the battery charging, it will not exit this stage unless there is adequate charging current from the solar panel. There should be NO load on the batteries when in equalization charging stage.

WARNING

Over-charging and excessive gas precipitation may damage the battery plates and activate material shedding on them. Too high of equalizing charge or for too long may cause damage. Please carefully review the specific requirements of the battery used in the system.

WARNING

Equalization may increase battery voltage to a level damaging to sensitive DC loads. Ensure that all load allowable input voltages are greater than the equalizing charging set point voltage.

Lithium Battery Activation

The Rover Boost has a reactivation feature to awaken a sleeping lithium battery. The protection circuit of lithium battery will typically turn the battery off and make it unusable if over-discharged. This can happen when storing a lithium battery pack in a discharged state for any length of time as self-discharge would gradually deplete the remaining charge. Without the wake-up feature to reactivate and recharge batteries, these batteries would become unserviceable and the packs would be discarded. The Rover Boost will apply a small charge current to activate the protection circuit and if a correct cell voltage can be reached, it starts a normal charge.

Communication Ports

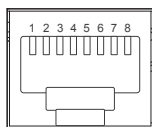

RS485 Port: The RS485 Port on the Rover Boost is dedicated to monitoring the controller through the BT-2 Bluetooth Module with extra features seen on the Renogy DC Home App. This will utilize an RJ45 Communication Cable.

NOTE

The accessory requires additional purchase

Pin No.	Parameter
1	+5V
2	RS485-A
3	RS485-B
4	GND

*RS485 initial baud rate is 9600bps

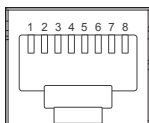

CAN bus: The controller area network port on the Rover Boost is dedicated to paralleling Rover Boost controllers utilizing the communication function for lithium batteries.

NOTE

The accessory requires additional purchase

Pin No.	Parameter
5	NC
6	CAN_H (CAN bus signal)
7	NC
8	CAN_L (CAN bus signal)

*CAN initial baud rate is 500Kbps

■ Host Mode Communication

For Renogy Smart Lithium batteries with BMS, the Rover Boost's RS485/CAN communication ports will be used to synchronize smart battery information and allow up to 2 x Rover Boosts to communicate with each other as separate but paralleled systems to the same battery bank. One controller in the system will be the Host, or the main controller, while the other controller will synchronize its logic to the Host controller. The Host controller will receive and assign battery charging information to the non-host controller, synchronizing charging logic for the connected controllers. The RS485/CAN communication functions have the following major advantages for Smart lithium Battery setups:

- **Improved and accurate Battery Charging**

Typical chargers have a preset logic when charging batteries. The logic is based off voltage setpoints and time limits. The advantage for the Lithium communication is that the controller will communicate with the BMS directly and adjusting charging for a more accurate and precise algorithm. Charging logic, assuming power supply source, may also charge longer than typical chargers for the most precise charging algorithm.

- **Direct BMS Communication**

Direct communication with the BMS gives the controller access to state of charge information and aids in BMS cell balancing for 100% charging. CAN logic reads battery BMS and communicates exact SOC% and voltage values which will keep sending charge until fully charged to 100%

The added communication between controller and battery automatically adjusts to the settings rated by the BMS directly.

- **No Battery Voltage Sensor Needed**

Accurate communication takes care of voltage compensation so that no battery voltage sensor is needed, as the most accurate charging algorithm is in place.

■ Host Mode on 48V Smart LFP Battery

CAUTION

Make sure the polarity is correct. Reverse polarity on a Lithium battery w/ BMS may cause irreversible damage to the charge controller and not covered by warranty.

Do not connect any solar panels to the Rover Boost when first setting up the battery.

NOTE

Use ethernet cables that are CAT5 or higher. Follow the steps below to set up the Rover Boost with the Renogy 48V Smart LFP Battery

1. Connect the Rover Boost to the positive and negative battery terminals
2. Set the battery type on the controller. In this case we will select 48V LFP, or purple.
3. Connect an ethernet cable between the Rover Boost's RS485 or CAN communication port and the Smart LFP Battery's CAN communication port.

4. Press and hold the SET button for 20 seconds on the Rover Boost. This will activate the CAN host function and the battery type light will flash once every 5 seconds. Now the controller is communicating and synchronizing the battery recognition information.

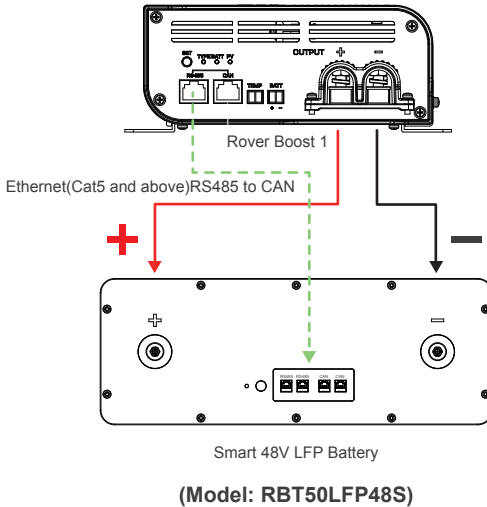

■ Paralleling 2 Rover Boosts w/ a 48V Smart LFP Battery

CAUTION

Make sure the polarity is correct. Reverse polarity on a Lithium battery w/ BMS may cause irreversible damage to the charge controller and not covered by warranty.

Do not connect any solar panels to the Rover Boost when first setting up the battery.

NOTE

Use ethernet cables that are CAT5 or higher

Up to 2 Rover Boosts can be connected in parallel and will charge at the same time maximizing energy in the Bulk/MPPT Stage. Once the Rover Boost enters Boost Stage, then the Host Function will automatically disable the non-Host Boost Controller as only 1 controller can be boosting on the Lithium battery bank. In the event Host function is accidentally pressed, long press again for 20 seconds to clear out of the host mode and exit.

1. To get started, both controllers need to be connected to the same battery bank. Correctly connect the positive and negative terminals from the Rover Boost 1 and Rover Boost 2 to the appropriate positive and negative terminals on the smart 48V LFP Battery. Then, connect an ethernet cable from the CAN port on Rover Boost 1 to the CAN port on Rover Boost 2. Lastly, select your Host Controller. We will assume Rover Boost 1.

2. Set the battery type on the host controller, Rover Boost 1. In this case we will select 48V LFP, or purple.

3. Next, run an ethernet cable between the Host controller's (Rover Boost 1) RS485 communication port to the CAN communication port on the 48V Smart LFP Battery.

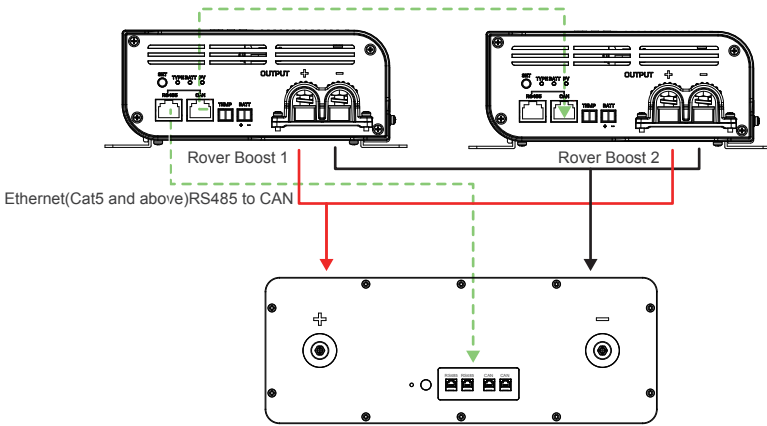

Smart 48V LFP Battery

(Model: RBT50LFP48S)

4. Press and hold the SET button for 20 seconds on Rover Boost 1. This will activate the CAN host function and the battery type light will flash once every 5 seconds. Only one Rover Boost at a time can be set as the host in a single system and during this time the controllers are communicating and synchronizing the battery recognition information.

5. Both Rover Boost controllers should have the same TYPE LED. The synchronization is complete and both controllers are now synced to the 48V Smart LFP Battery

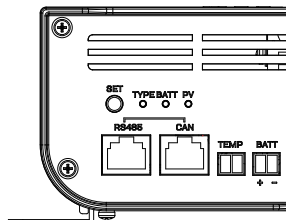

■ Paralleling 2 Rover Boosts w/ Non-Lithium

In Non-lithium batteries, the batteries do not have a BMS and will not be able to communicate synchronization information. Therefore, it is recommended to keep the controller's distance and wiring the same so the controllers can both detect the same battery bank and connect in parallel. Therefore, the CAN Host function will not be in effect for Non-Lithium batteries.

1. To get started, simply connect both Rover Boost controllers to the same battery bank.

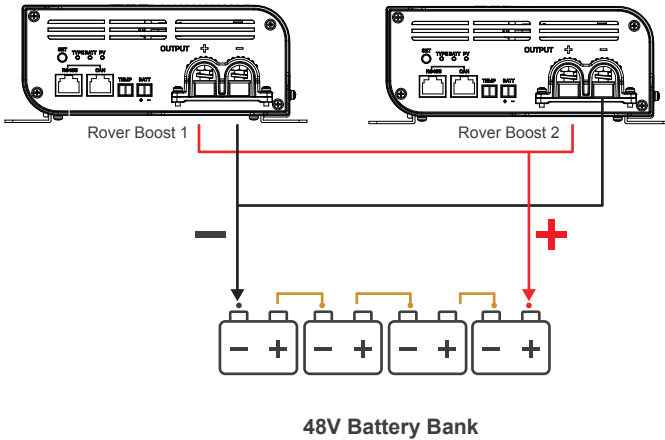

Electronic Protections and Troubleshooting

The Rover Boost is equipped with electronic protections to protect the controller and the system. If the Rover Boost is not functioning correctly, it may be undergoing an internal electronic protection. This is not indicative of a defective controller but may require some troubleshooting to resume normal operation mode.

The Rover Boost has the following protections: battery undervoltage warning, battery overvoltage, battery over-temperature, battery under-temperature, battery reverse polarity, battery open circuit, PV reverse polarity, PV overvoltage, PV short circuit, PV Power Limiting, back-flow protection, and controller internal over-temperature.

BATT LED

BATT LED	Behavior	Protection	Cause / Fix
Red	Always on Bright, always on	Battery undervoltage warning	The controller is detecting a low battery voltage and alerting the user 1. Use a multi-meter to check the battery reading and verify whether the LED matches your intended battery type and voltage. If the battery is low, disconnect any loads and let the battery charge for an extended period.
Red	Slow Flashing ON 1 second, OFF 1 second, cycle is 2 seconds	Battery over discharged; disconnected	The battery has discharged below the under-voltage warning and needs to be recharged. The controller has stopped charging utilizing the electronic protection and may have disconnected from the system. 1. Use a multi-meter to read the battery charging voltage and verify the voltage is within the battery charging parameters seen in Technical Specifications – Battery Charging for your respective type. 2. Disconnect any loads from the battery and ensure your panels are working and let the Rover Boost charge the battery.
–	OFF	Battery Reverse Polarity	The battery is connected to the controller but not charging or not detected. This is a protection for non-lithium batteries. Extra caution must be taken with Lithium batteries in reverse polarity. This may cause irreversible damage to the unit as a reversely connected battery may be interpreted as a discharged battery and undergo Lithium Activation. 1. Use a multi-meter to verify a battery voltage as well as the battery voltage being within a 36V / 48V system by comparing your values against the Technical Specifications – Battery Charging, for your respective type.

			<p>2. Use a multi-meter to verify the correct positive and negative polarity matches the polarity seen on the OUTPUT port.</p> <p>CAUTION Use extra caution when connecting to Lithium batteries. Reverse polarity protection is valid unless there's PV input source connected.</p>
-	<p>Quick Flashing</p> <p>ON 0.1 second, OFF 0.1 second, cycle is 0.2 seconds</p>	Battery Overvoltage	<p>The battery is charging at a higher rate than the system voltage. The controller has stopped charging utilizing the electronic protection.</p> <ol style="list-style-type: none"> 1. Use a multi-meter to read the battery charging voltage and verify the voltage is within the battery charging parameters seen in Technical Specifications – Battery Charging for your respective type. 2. Verify the correct battery voltage for Non-lithium batteries or verify the correct TYPE LED for LFP batteries. 3. Toggle the controller by disconnecting and reconnecting the battery to verify the proper system voltage (36V/48V). 4. Check your solar panel input. Use a multi-meter to check that the incoming voltage is within 15 ~ 40V. If this is a 36V system, the PV voltage should not exceed 15 ~ 25VDC
-	<p>Quick Flashing</p> <p>ON 0.1 second, OFF 0.1 second, cycle is 0.2 seconds</p>	Battery Over-temperature	<p>The battery is in an environment where it is over-heating via utilizing the default 77° F /25°C or directly observed if using a temperature sensor. In addition, this could indicate the battery s outside the normal operating range of -31°F/ -35 C ~ 149°F /+ 65 C</p> <ol style="list-style-type: none"> 1. If Battery temperature is above the -31°F/ -35 C ~ 149°F /+ 65 C range, the controller will stop charging and only resume charging when the temperature is within the range again. 2. Place the controller in a ventilated area or add ventilation to your setup to rapidly cool the controller.
-	-	Battery Open Circuit	<p>The battery has unexpectedly disconnected from the controller with active PV power running, no damage to the controller despite PV running with no battery bank.</p> <ol style="list-style-type: none"> 1. Use a multi-meter to verify proper connections to the OUTPUT battery terminal. Upon successful connection, the controller will resume normal charging. 2. If you are using a fuse, double check the fuse to make sure it has not been compromised.

PV LED

PV	Behavior	Protection	Cause / Fix						
-	OFF	PV Reverse Polarity	<p>The panels are connected to the controller but not charging or not detected.</p> <ol style="list-style-type: none"> 1. Use a multi-meter to verify a PV voltage as well as the voltage being within 15 – 40VDC 2. Use a multi-meter to verify the correct positive and negative polarity matches the polarity seen on the OUTPUT port. 						
-	OFF	PV Overvoltage	<p>The panels voltage is higher than the controller's maximum input.</p> <ol style="list-style-type: none"> 1. Use a multi-meter to verify a PV voltage as well as the voltage being within 15 – 40 VDC. 2. Check your solar panel input against your battery system voltage. Use a multi-meter to check that the incoming voltage is within 15 ~ 40VDC for 48V systems. If this is a 36V system, the PV voltage should not exceed 15 ~ 25VDC. 						
Green	Double Flashing ON 0.1 seconds, OFF 0.1 second, ON 0.1 seconds, OFF 1.7 seconds	Lithium Activation	<p>If you are using a Lithium battery, it may have undergone over-discharged protection and the Rover Boost is attempting to wake-up the battery. Refer to Lithium Activation in the MPPT Technology Section for more information.</p> <ol style="list-style-type: none"> 1. Use a multi-meter to measure your battery voltage and determine whether it has undergone a protection mode. Disconnect any loads and let the Rover Boost charge and wake the Lithium battery. 						
-	Double Flashing ON 0.1 seconds, OFF 0.1 second, ON 0.1 seconds, OFF 1.7 seconds	PV Power Limiting	<p>In non-lithium setups or setups where the Lithium battery is fine, the Rover Boost's rated PV watts have been exceeded and it is therefore current limiting.</p> <ol style="list-style-type: none"> 1. Double Flashing will continue until the Controller has exited MPPT/Bulk stage. Afterwards, it will continue through the normal charge state LEDs. There is no issue, and this is a protected function of the Rover Boost if the PV watts stay within the designated values: <table border="1" data-bbox="466 1278 958 1361"> <thead> <tr> <th></th> <th>Power Limiting Watts</th> </tr> </thead> <tbody> <tr> <td>36V</td> <td>Up to 600W</td> </tr> <tr> <td>48V</td> <td>Up to 800W</td> </tr> </tbody> </table> <p>WARNING Exceeding the Protection Mode Limits may result in irreversible damage and not covered by warranty.</p>		Power Limiting Watts	36V	Up to 600W	48V	Up to 800W
	Power Limiting Watts								
36V	Up to 600W								
48V	Up to 800W								

More Troubleshooting Behaviors

Behavior	Probable Cause	Cause / Fix
The system is dead; no LEDs	No battery Power	The battery may be experiencing an electronic protection, see disconnected, over-discharged, reverse polarity, over/under temperature in BATT chart above for individual fixes.
PV will not display or charge	PV Not detected or incorrectly connected	The solar panels may be experiencing an electronic protection, see reverse polarity, overvoltage in the PV chart above.
Charging current is lower than expected; PV current may also be low	<ol style="list-style-type: none"> 1.Float mode 2.Shaded Panels 3.Low Insolation 4.High temperature 5.Improper wiring 	<ol style="list-style-type: none"> 1.The controller is normally operating an in Float mode, where the current is reduced to control and maintain the battery 2.Inspect the solar panels for any dust or debris on the surface. Clear anything creating shade to resume normal operation 3.Atmospheric conditions such as low clouds, haze, sun setting will reduce the panel output as the insolation conditions also drop attributing the lower power output. Clearer conditions will increase performance 4.While not outside of operating conditions, higher temperature reduce the efficiency of the solar panels with excess heat, where the maximum power voltage is not much higher than the battery voltage, leaving little to Boost. Check the solar module against the typical solar module chart to potentially switch the module. 5.The panels are experiencing higher voltage drop due to undersized wiring, poor connections, or perhaps higher environmental conditions. Double check and secure all connections and verify correct gauges.
Rover Boost was Charging but then stopped	High ambient temperature	High temperature or residual temperature may prevent the controller from resuming charge. Ventilate the charge controller location or reduce PV power to lower heat.
Rover Boost not charging properly	Incorrect Battery Type	Non-lithium batteries have an automatic detection feature based on the voltage of the battery to determine 36V or 48V charging. If you have a 48V Battery, make sure to press the SET button to toggle the controller to a 48V battery system, as it may be thinking it is a 36V system. For 36V systems, do not toggle the SET button and it will resume 36V system recognition.

Maintenance

Inspect the Rover Boost from time to time to ensure proper performance. For best controller performance:

1. Check the wiring going into the controller from the PV side and BATT side. Make sure there is no wire damage or heavy exposure wear on the wiring
2. Tighten all terminals to ensure a secure connection and avoid added any resistance and heat build-up.
3. Inspect the Rover Boost for any external damage, environmental damage, or corrosion
4. Ensure PV array does not exceed the voltages designated for 36V and 48V battery charging.
5. Clean the controller as required with a cloth.

Technical Specifications

Model	RCC10RVRB
Rated System Voltage	36V / 48V, Auto Recognition (Non-Lithium)
Rated Charge Current	10A
Battery Operating Range	30 ~ 65 VDC
Battery Types	AGM, GEL, FLOODED, LFP, USER
Rated Max Charge Power	PV Input Power: 500W/36V; 650W/48V Charging Power: 450W/36V; 600W/48V
Max Input Current (short-circuit, I _{sc})	35A
Power Limiting Protection	Up to 600W/36V; 800W/48V
Solar Input Voltage Range (VOC)	15 ~ 25VDC @ 36V 15 ~ 40VDC @ 48V
MPPT Voltage Range	15 ~ 25VDC @ 36V 15 ~ 40VDC @ 48V
MPPT Tracking Efficiency	≥ 99%
MPPT Charge Conversion Efficiency	≥ 90%
Idle Consumption	≤ 2W
Operating Temperature Range	-31°F ~ 149°F / -35°C ~ +65°C
Storage Temperature Range	-40°F ~ 176°F / -40°C ~ +80°C
Temperature Compensation	-3mV / °C / 2V (Non-Lithium) 0mV / °C / 2V; no compensation (Lithium)
Grounding Type	Common Negative Lug (M3)
Enclosure Rating	IP20
Humidity	0-95% RH
Electronic Protections	Battery overcharging, Battery over discharge, Battery reverse polarity protection, PV reverse polarity, PV Reverse flow, PV Short circuit, PV Power Limiting, Controller internal over-temperature protection, Charging over-current protection
Communication	RS485 / CAN bus signal
Dimensions	8.8 x 7.6 x 2.9 inch / 223.9 x 191.9 x 74.5mm
Weight	2.65 lbs / 1.2 Kg
Terminal Range	16 ~ 2 AWG
Terminal Size	M6x12x1mm
Certification	CE, FCC Part 15 Class B, RoHS

Battery Charging Parameters

Parameter	AGM	GEL	FLD	36V LFP**	48V LFP**	USER**
Overvoltage Disconnect	16V	16V	16V	44.4V	55.5V	59.2V (27 ~ 68V adjustable)
Equalization Voltage	---	---	14.8V	---	---	57.6V (27 ~ 68V adjustable)
Boost Voltage	14.6V	14.2V	14.6V	43.2V (42~45V adjustable)	54V (52~56V adjustable)	57.6V (27 ~ 68V adjustable)
Float Voltage	13.8V	13.8V	13.8V	---	---	57.6V (27 ~ 68V adjustable)
Boost Recover Voltage	13.2V	13.2V	13.2V	40.8V	50.8V	54.4V (27 ~ 68V adjustable)
Undervoltage Recover	12.6V	12.6V	12.6V	38.4V	48V	51.2V (27 ~ 68V adjustable)
Undervoltage Warning	12.0V	12.0V	12.0V	36.4V	45.6V	48.6V (27 ~ 68V adjustable)
Over discharged Voltage	11.1V	11.1V	11.1V	35.8V	44.8V	47.8V (27 ~ 68V adjustable)
Discharge Limit Voltage	10.6V	10.6V	10.6V	34.2V	42.8V	45.6V (27 ~ 68V adjustable)
Over discharge delay time	5 s	5 s	5 s	30 s	30 s	30 s (1 ~ 120s adjustable)
Boost Charge Duration	120 min	120 min	120 min	---	---	0 min (0 ~ 600min adjustable)
Equalization Interval	---	---	30 days	---	---	0 days (0 ~ 255days adjustable)
Equalization Duration	---	---	120 min	---	---	0 min (10 ~ 600min adjustable)

NOTE

By Default, User mode operates as a 48V LFP (16S) battery profile. Each parameter can be individually adjusted to adjust the profile to a 48V User Lithium Charge Profile or a 48V User Non-Lithium Charger Profile.





1. 48V User Lithium batteries will need to indicate the same charging voltage for "Equalization", "Boost Voltage", and "Float Voltage" as the logic will then understand this to mean Lithium.
2. 48V User Non-Lithium batteries will need to indicate different charging voltage for "Equalization", "Boost Voltage", and "Float Voltage" and will not support functions such as Lithium activation function and low temperature heating function;

NOTE

36V LFP (12S) and 48V LFP (15S) can only adjust the Boost Voltage. Once adjusted, the remaining parameters will adjust and synchronize automatically.



The User parameters are assumed to be 77°F /25 °C / in 12V system parameters. For 36V systems multiply the parameters × 3, 48V systems multiply the parameters × 4.

**Users responsibility to match battery spec.
User error will not be covered in warranty claim.**

US |  2775 E Philadelphia St, Ontario, CA 91761, USA
 909-287-7111
 www.renogy.com
 support@renogy.com

CN |  苏州高新区科技城培源路1号5号楼-4
 400-6636-695
 <https://www.renogy.cn>
 support@renogy.cn

JP |  <https://www.renogy.jp>
 supportjp@renogy.com

CA |  <https://ca.renogy.com>
 supportca@renogy.com

AU |  <https://au.renogy.com>
 supportau@renogy.com

UK |  <https://uk.renogy.com>
 supportuk@renogy.com

DE |  <https://de.renogy.com>
 supportde@renogy.com