

Utility or Generator
120/240VAC Output

SPD300 SPD300

120/240VAC
Load Panel

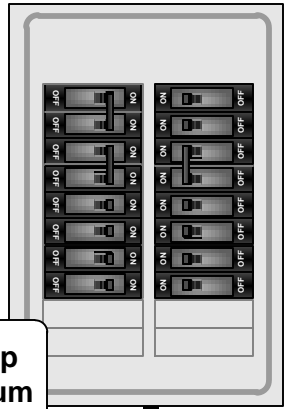
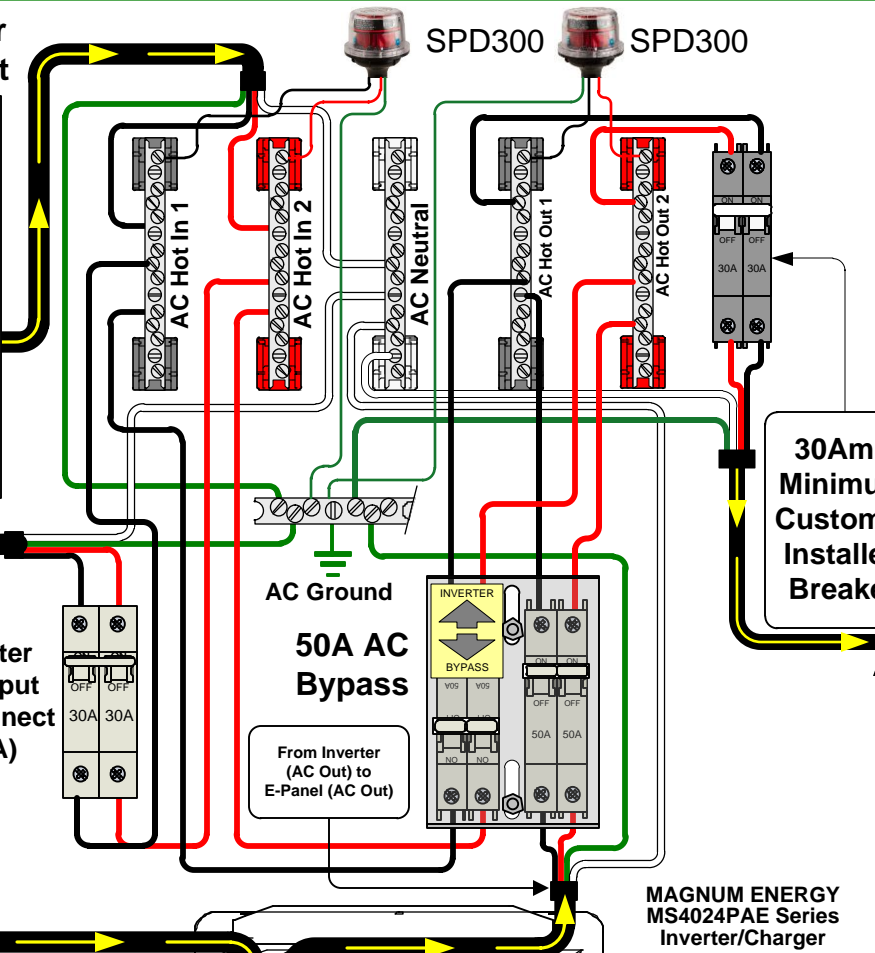
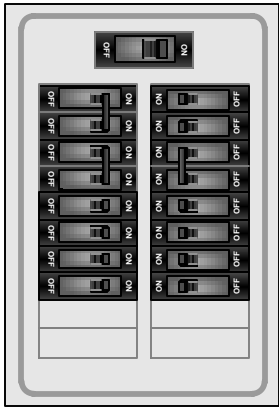

30Amp Minimum
Customer
Installed
Breaker

From
E-Panel
(AC In)
to
Inverter
(AC In)

Inverter
AC Input
Disconnect
(30A)

AC Ground
50A AC
Bypass

From Inverter
(AC Out) to
E-Panel (AC Out)

From
E-Panel
(AC out)
to
Load
Center

MAGNUM ENERGY
MS4024PAE Series
Inverter/Charger

Optional Breakers/Disconnects
(6 spaces max @ 13mm)

AC WIRING

DC WIRING

Remote Control RC-50,
ARC50 or Magnum Router

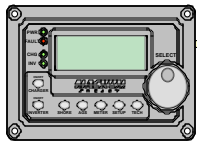

Battery
Temperature
Sensor

DC -
Buss

DC Shunt

Main Battery
Shutoff 250A

DC +
Buss

MIDNITE SOLAR
Classic 250
Controller

PV Panels

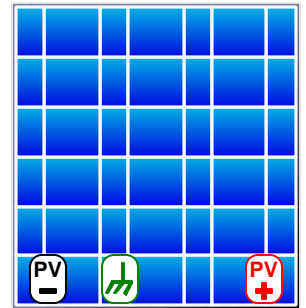

PV +
Buss

Battery Bank
(24VDC)

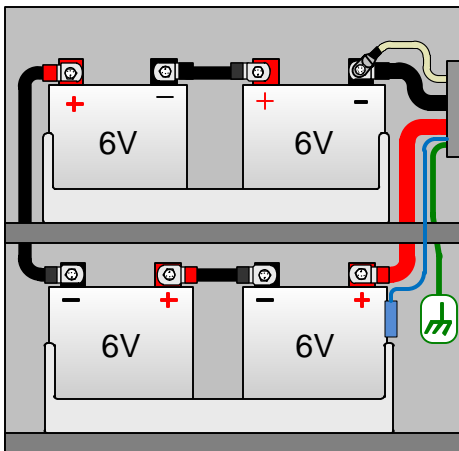

DC Ground

PV Output MNEC80

PV + Input
MNEC60-300

SPD300

Note AC and DC Grounds go to the Same
BusBar, Drawn Separate for clarity