

# EG4-3000EHV-48

## USER MANUAL

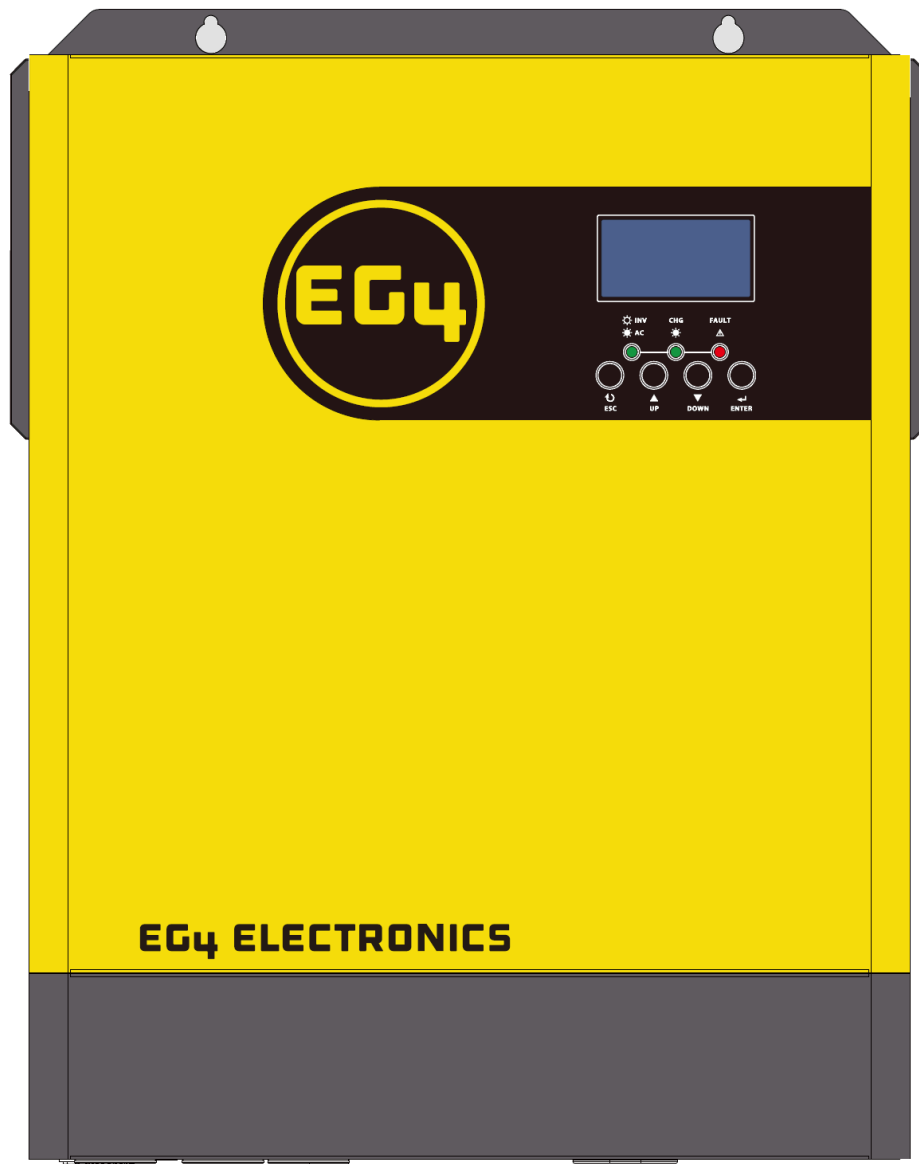

## TABLE OF CONTENTS

1.	Technical Specifications .....	1
2.	Abbreviations .....	3
3.	Inverter Safety .....	4
3.1	Safety Instructions.....	4
3.2	Important Safety Notifications.....	4
4.	Sécurité de la batterie .....	6
4.1	Consignes de sécurité .....	6
4.2	Notifications de sécurité importantes .....	6
5.	Brief Introduction.....	8
5.1	Inverter Features .....	8
5.2	Basic System Architecture .....	8
5.3	Product Overview .....	9
6.	Installation.....	10
6.1	Packaging List and Placement .....	10
6.2	Location Selection and Installation.....	10
6.2.1	Requirements for Installation Location.....	10
6.2.2	Preparation.....	10
6.2.3	Installing the Inverter .....	11
6.3	PV Connection.....	12
6.3.1	Connecting PV to the Inverter .....	12
6.3.2	PV System Parameters .....	13
6.3.3	PV Module Wire Connection.....	13
6.4	Battery Connection .....	14
6.5	AC Input/Output Connection .....	16
6.6	Final Assembly .....	18
7.	Operation Guide.....	18
7.1	Dry Contact Signal.....	18
7.2	Start-Up & Shutdown Procedures.....	19
7.3	LCD Display .....	20
7.3.1	LED Indicator .....	20
7.3.2	Function Keys.....	20
7.3.3	LCD Display Icons.....	21
7.4	Program Settings .....	23
7.4.1	Program Settings.....	24
7.5	Display Setting .....	34
7.6	Operating Mode Description.....	38
7.7	Typical Applications.....	41
7.7.1	120V Single Phase in Parallel.....	41
7.7.2	240/120V Split-Phase in Parallel.....	42
7.8	Parallel Installation Guide.....	42
7.8.1	Instructions .....	42
7.8.2	Package Contents.....	43
7.8.3	Mounting the Unit.....	43

7.8.4	Wiring Connection .....	44
7.9	Communicating with battery BMS in parallel system .....	45
7.10	Three inverters in Single Phase Parallel: .....	46
7.11	Four Inverters in Single Phase Parallel.....	47
7.12	Five inverters in Single Phase Parallel.....	48
7.13	Six inverters in Single Phase Parallel.....	48
8.	Support 3-phase equipment .....	49
8.1	One Inverter in each phase.....	49
8.2	Three inverters in each phase:.....	49
9.	Support for Parallel Split-Phase (120V/240V) .....	52
9.1	Two Inverters in parallel split-phase .....	52
9.2	Greater than two inverters in parallel Split-Phase .....	53
9.3	PV Connection.....	53
9.4	Split-Phase and 3 Phase LCD Setting and Display .....	54
9.4.1	Setting Program:.....	54
9.4.2	Fault code display: .....	55
9.4.3	Warning code display:.....	55
9.5	Commissioning Parallel Systems .....	56
9.6	Parallel Troubleshooting Guide.....	57
10.	Lithium battery settings.....	61
10.1	Lithium Battery BMS Connection .....	61
10.1.1	Lithium battery communication and settings .....	61
10.2	LCD Setting .....	62
10.2.1	LCD Display .....	63
10.3	Settings for EG4 Lithium Batteries.....	63
10.4	Settings for Lithium battery without communication .....	65
11.	Inverter Maintenance .....	67
12.	Troubleshooting Guide.....	67
12.1	Faults.....	68
12.2	Fault Codes .....	70
12.3	Fault Reference Codes.....	72
12.4	Warning Indicators .....	73
13.	Wi-Fi Communications Dongle.....	74
13.1	Installation and Setup.....	74
13.1.1	Installation.....	74
13.1.2	Account creation.....	75

## 1. TECHNICAL SPECIFICATIONS

LINE MODE SPECIFICATIONS	
INPUT VOLTAGE WAVEFORM	Sinusoidal (utility or generator)
NOMINAL INPUT VOLTAGE	120VAC
LOW LOSS VOLTAGE	95VAC± 7V (UPS); 65VAC± 7V (Appliances)
LOW LOSS RETURN VOLTAGE	100VAC± 7V (UPS);70VAC± 7V (Appliances)
HIGH LOSS VOLTAGE	140VAC ±7V
HIGH LOSS RETURN VOLTAGE	135VAC ±7V
MAX AC INPUT VOLTAGE	150VAC
MIN AC INPUT VOLTAGE	Electronics: 95 - 140VAC Home Appliances: 65 - 140VAC
NOMINAL INPUT FREQUENCY	50Hz / 60Hz (Auto detection)
LOW LOSS FREQUENCY	40 ±1Hz
LOW LOSS RETURN FREQUENCY	42 ±1Hz
HIGH LOSS FREQUENCY	65 ±1Hz
HIGH LOSS RETURN FREQUENCY	63 ±1Hz
OUTPUT SHORT CIRCUIT PROTECTION	Line mode: Circuit Breaker 30A Battery mode: Solid State FETs 400A
EFFICIENCY (LINE MODE)	[8 95% (Rated R load, battery full charged)
TRANSFER TIME	10ms typical (UPS); 20ms typical (Appliances)

OUTPUT POWER DERATING:  
WHEN AC INPUT VOLTAGE DROPS TO 95V, THE OUTPUT  
POWER WILL BE DERATED.

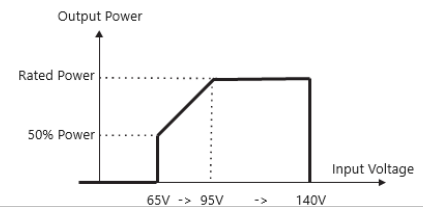

INVERTER MODE SPECIFICATIONS	
RATED OUTPUT POWER	3kVA/3kW
OUTPUT VOLTAGE WAVEFORM	Pure Sine Wave
OUTPUT VOLTAGE REGULATION	110/120VAC ±5%
OUTPUT FREQUENCY	60Hz or 50Hz
BATTERY TO INVERTER EFFICIENCY	94%
PV TO INVERTER EFFICIENCY	97%
OVERLOAD PROTECTION	5s@ ≈150% load; 10s@110% ≈150% load
SURGE CAPACITY	2 X rated power for 5 seconds
NOMINAL DC INPUT VOLTAGE	48 VDC
MPPT STARTUP VOLTAGE	120 VDC
LOW DC WARNING VOLTAGE, @LOAD< 20%	44.0 VDC
LOW DC WARNING VOLTAGE, @ 20% ≤ LOAD < 50%	42.8 VDC
LOW DC WARNING VOLTAGE, @LOAD ≥ 50%	40.4 VDC
LOW DC WARNING RETURN VOLTAGE, @LOAD< 20%	46.0 VDC
LOW DC WARNING RETURN VOLTAGE, @ 20% ≤ LOAD < 50%	44.8 VDC
LOW DC WARNING RETURN VOLTAGE, @LOAD ≥ 50%	42.4 VDC
LOW DC CUT-OFF VOLTAGE, @LOAD< 20%	42.0 VDC
LOW DC CUT-OFF VOLTAGE, @ 20% ≤ LOAD < 50%	40.8 VDC
LOW DC CUT-OFF VOLTAGE, @LOAD ≥ 50%	38.4 VDC

## UTILITY CHARGING MODE

CHARGING CURRENT (AC)	60Amp (@ VI/P=120Vac)
CHARGING CURRENT (PV+AC)	80Amp (@ VI/P=120Vac)
BULK CHARGING VOLTAGE - FLOODED BATTERY	58.4 Vdc
BULK CHARGING VOLTAGE - AGM / GEL BATTERY	56.4 Vdc
FLOATING CHARGING VOLTAGE	54Vdc
OVERCHARGE PROTECTION	63Vdc
CHARGING ALGORITHM	3-Step

## CHARGING CURVE

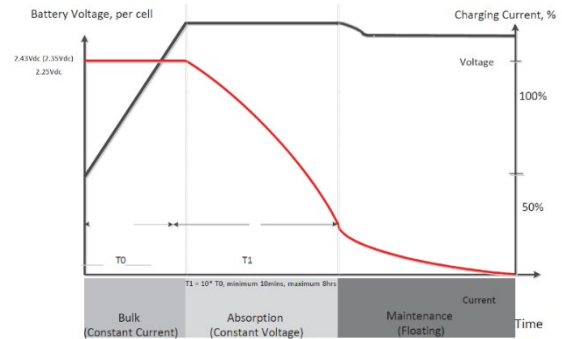

## SOLAR INPUT

RATED POWER	5000W
MAX. PV ARRAY OPEN CIRCUIT VOLTAGE	500VDC
PV ARRAY MPPT VOLTAGE RANGE	120VDC~450VDC
MAX. CURRENT DRAW	18A
NUMBER OF MPPT	1
START UP VOLTAGE	42 VDC
MAX CHARGING CURRENT (PV)	80A

## GENERAL SPECIFICATIONS

SAFETY CERTIFICATION	CE
OPERATING TEMPERATURE RANGE	-10°C – 55°C (14°F to 131°F)
STORAGE TEMPERATURE	-15°C – 60°C (5°F to 140°F)
HUMIDITY	5% to 95% Relative Humidity (Non-condensing)
DIMENSION (D*W*H)	16.5 x 13.4 x 5.6 in. (420 mm x 340 mm x 142 mm)
NET WEIGHT, KG/LBS.	8.2kg / 18lb
USB	No USB Port
RS-232	Yes
RS-485	Yes   USB Type A
DRY CONTACT	Yes
OPERATING ALTITUDE	0~1500m
IDLE POWER CONSUMPTION	<70W
ENCLOSURE RATING	IP 21 (Indoor Use)
WARRANTY	3 Years

## PARALLEL SPECIFICATIONS

MAXIMUM UNITS IN PARALLEL	12
CIRCULATION CURRENT (NO LOAD)	<2A
POWER IMBALANCE RATIO	<5%
PARALLEL COMMUNICATION	CAN
TRANSFER TIME(PARALLEL)	<20ms
PARALLEL KIT	Built In (RJ45 Port)

## 2. ABBREVIATIONS

- AWG – American Wire Gauge
- A – Amps
- Ah – Amp hour(s)
- AC – Alternating Current
- AFCI – Arc-Fault Circuit Interrupter
- AHJ – Authority Having Jurisdiction
- kAIC – kilo-Amp Interrupting Capability
- ANSI – American National Standards Institute
- BAT – Battery
- BMS – Battery Management System
- COM – Communication
- CT – Current Transformer
- DC – Direct Current
- DIP – Dual In-line Package
- DOD – Depth of Discharge
- EG – Equipment Ground
- EGS – Equipment Grounding System
- EMC – Electromagnetic Compatibility
- EPS – Emergency Power System
- ESS – Energy Storage System
- E-Stop – Emergency Stop
- FCC – Federal Communication Commission
- GE – Grounding Electrode
- GEC – Grounding Electrode Conductor
- GFCI – Ground Fault Circuit Interrupter
- GFDI – Ground Fault Detector/Interrupter
- Imp – Maximum Power Point Current
- IEEE – Institute of Electrical and Electronic Engineers
- IP – Ingress Protection
- Isc – Short-Circuit Current
- In-lbs. – Inch Pounds
- kW – Kilowatt
- kWh – Kilowatt-hour
- LCD – Liquid Crystal Display
- LFP – Lithium Iron Phosphate
- L1 – Line 1
- L2 – Line 2
- mm – Millimeters
- MPPT – Maximum Power Point Tracking
- mV – Millivolt
- N – Neutral
- NEC – National Electric Code
- NEMA – National Electrical Manufacturers Association
- NFPA – National Fire Prevention Association
- Nm – Newton Meters
- NOCT – Normal Operating Cell Temperature
- PC – Personal Computer
- PCB – Printed Circuit Board
- PE – Protective Earth
- PPE – Personal Protective Equipment
- PV – Photovoltaic
- RSD – Rapid Shut Down
- SCC – Standards Council of Canada
- SOC – State of Charge
- STC – Standard Testing Conditions
- UL – Underwriters Laboratories
- UPS – Uninterrupted Power Supply
- V – Volts
- VOC – Open-Circuit Voltage
- VMP – Voltage Maximum Power

## 3. INVERTER SAFETY

### 3.1 SAFETY INSTRUCTIONS

International safety regulations have been strictly observed in the design and testing of the inverter. Before beginning any work, carefully read all safety instructions, and always observe them when working on or with the inverter. The installation must follow all applicable national or local standards and regulations.

Incorrect installation may cause:

- Injury or death to the installer, operator or third party
- Damage to the inverter or other attached equipment

### 3.2 IMPORTANT SAFETY NOTIFICATIONS



**DANGER:** *Hazardous Voltage Circuits!*  
**AVERTISSEMENT!** *Circuits à tension élevée!*

There are various safety concerns that must be carefully observed before, during, and after the installation, as well as during future operation and maintenance. The following are important safety notifications for the installer and any end users of this product under normal operating conditions.

1. **Beware of high PV voltage.** Install an external DC disconnect switch or breaker and ensure it is in the “off” or “open” position before installing or working on the inverter. Use a voltmeter to confirm there is no DC voltage present to avoid electric shock.
2. **Beware of high grid voltage.** Ensure the AC switch and/or AC breaker are in the “off” or “open” position before installing or working on the inverter. Use a voltmeter to confirm there is no voltage present to avoid electric shock.
3. **Beware of high battery current.** Ensure that the battery module breakers and/or on/off switches are in the “open” or “off” position before installing or working on the inverter. Use a voltmeter to confirm there is no DC voltage present to avoid electric shock.
4. **Do not open the inverter while it is operating to avoid electric shock and damage from live voltage and current within the system.**
5. Do not make any connections or disconnections (PV, battery, grid, communication, etc.) while the inverter is operating.
6. An installer should make sure to be well protected by reasonable and professional insulative equipment [e.g., personal protective equipment (PPE)].
7. Before installing, operating, or maintaining the system, it is important to inspect all existing wiring to ensure that it meets the appropriate specifications and conditions for use.
8. Ensure that the PV, battery, and grid connections to the inverter are secure and proper to prevent damage or injuries caused by improper installation.
9. Some components of the system can be very heavy. Be sure to utilize team-lift among other safe lifting techniques throughout the installation.



## **WARNING: TO REDUCE THE RISK OF INJURY, READ ALL INSTRUCTIONS!**

All work on this product (system design, installation, operation, setting, configuration, and maintenance) must be carried out by qualified personnel. To reduce the risk of electric shock, do not perform any servicing other than those specified in the operating instructions unless qualified to do so.

1. Read all instructions before installing. For electrical work, follow all local and national wiring standards, regulations, and these installation instructions.
2. Make sure the inverter is properly grounded. All wiring should be in accordance with the National Electrical Code (NEC), ANSI/NFPA 70.
3. The inverter and system can inter-connect with the utility grid only if the utility provider permits. Consult with the local AHJ (Authority Having Jurisdiction) before installing this product for any additional regulations and requirements for the immediate area.
4. All warning labels and nameplates on the inverter should be clearly visible and must not be removed or covered.
5. The installer should consider the safety of future users when choosing the inverter's correct position and location as specified in this manual.
6. Keep children from touching or misusing the inverter and relevant systems.
7. **Beware!** The inverter and some parts of the system can be hot when in use. Do not touch the inverter's surface or most of the parts when they are operating. During operation, only the LCD and buttons should be touched.



## **WARNING!**

Cancer and Reproductive Harm – See [www.P65Warnings.ca.gov](http://www.P65Warnings.ca.gov) for more details.

### DISCLAIMER

EG4 reserves the right to make changes to the material herein at any time without notice. Please refer to [www.eg4electronics.com](http://www.eg4electronics.com) for the most updated version of our manuals/spec sheets.

## 4. SÉCURITÉ DE LA BATTERIE

### 4.1 CONSIGNES DE SÉCURITÉ

Avant de commencer tout travail, lisez attentivement toutes les consignes de sécurité et respectez-les toujours lorsque vous travaillez sur ou avec la batterie. L'installation doit être conforme à toutes les normes et réglementations nationales ou locales applicables. Consultez l'autorité compétente locale et/ou le service public pour obtenir les permis et les autorisations appropriés avant l'installation.

Une installation incorrecte peut entraîner les effets suivants :

- Blessure ou décès de l'installateur, de l'exploitant ou d'un tiers
- Dommages à la batterie ou à tout autre équipement attaché

### 4.2 NOTIFICATIONS DE SÉCURITÉ IMPORTANTES



**DANGER:**

***Circuits à haute tension!***

Il existe divers problèmes de sécurité qui doivent être soigneusement observés avant, pendant et après l'installation, ainsi que lors de l'utilisation et de la maintenance futures. Ce qui suit sont des notifications de sécurité importantes pour l'installateur et tout utilisateur final de ce produit dans des conditions de fonctionnement normales.

1. **Ne démontez pas la batterie.** Contactez le distributeur pour tout problème nécessitant une réparation pour plus d'informations et des instructions de manipulation appropriées. Un entretien ou un remontage incorrect peut entraîner un risque d'électrocution ou d'incendie et annuler la garantie.
2. **Ne court-circuitez jamais les entrées CC.** Un court-circuit de la batterie peut entraîner un risque d'électrocution ou d'incendie et peut entraîner des blessures graves ou la mort et/ou des dommages permanents à l'appareil et/ou à tout équipement connecté.
3. **Soyez prudent lorsque vous travaillez avec des outils métalliques sur ou à proximité des batteries et des systèmes.** Le risque d'arcs électriques et/ou de court-circuit de l'équipement peut entraîner des blessures graves ou la mort et des dommages à l'équipement.
4. **Attention au courant de batterie élevé.** Assurez-vous que les disjoncteurs du module de batterie et/ou les interrupteurs marche/arrêt sont en position « ouvert » ou « arrêt » avant d'installer ou de travailler sur la batterie. Utilisez un voltmètre pour confirmer qu'il n'y a pas de tension présente afin d'éviter les chocs électriques.
5. **N'effectuez aucune connexion ou déconnexion du système pendant que les batteries fonctionnent.** Des dommages aux composants du système ou un risque d'électrocution peuvent survenir si vous travaillez avec des batteries sous tension.
6. Assurez-vous que le banc de batteries est correctement mis à la terre.
7. Un installateur doit s'assurer d'être bien protégé par un équipement isolant raisonnable et professionnel [par exemple, un équipement de protection individuelle (EPI)].

8. Avant d'installer, d'utiliser ou d'entretenir le système, il est important d'inspecter tout le câblage existant pour s'assurer qu'il répond aux spécifications et aux conditions d'utilisation appropriées.
9. Assurez-vous que les connexions de la batterie et des composants du système sont sécurisées et appropriées pour éviter les dommages ou les blessures causés par une mauvaise installation.



## **AVERTISSEMENT : Pour réduire le risque de blessure, lisez toutes les instructions !**

Tous les travaux sur ce produit (conception du système, installation, fonctionnement, réglage, configuration et maintenance) doivent être effectués par du personnel qualifié. Pour réduire le risque d'électrocution, n'effectuez aucun entretien autre que ceux spécifiés dans le mode d'emploi, à moins d'être qualifié pour le faire.

10. Lisez toutes les instructions avant de commencer l'installation. Pour les travaux électriques, suivez toutes les normes de câblage locales et nationales, les réglementations et ces instructions d'installation. Tout le câblage doit être conforme au Code national de l'électricité (NEC), ANSI/NFPA 70.
11. La batterie et le système ne peuvent se connecter au réseau public que si le fournisseur d'électricité l'autorise. Consultez l'AHJ local avant d'installer ce produit pour connaître les réglementations et exigences supplémentaires de la région.
12. Toutes les étiquettes d'avertissement et les plaques signalétiques de cette batterie doivent être clairement visibles et ne doivent pas être retirées ou couvertes.
13. L'installateur doit tenir compte de la sécurité des futurs utilisateurs lors du choix de la position et de l'emplacement corrects de la batterie, comme spécifié dans ce manuel.
14. Tenez les enfants à l'écart de la batterie et des systèmes concernés ou de les utiliser à mauvais escient.

La batterie est conçue pour arrêter de se charger lorsqu'elle atteint le seuil bas de 23 °F. Si un courant de charge est observé lorsque la température interne de la batterie est inférieure à 23 °F, débranchez immédiatement la batterie et consultez le distributeur.



**Cancer et troubles de la reproduction – Voir [www.P65Warnings.ca.gov](http://www.P65Warnings.ca.gov) pour plus de détails.**

### **DISCLAIMER**

EG4® se réserve le droit de modifier le contenu de ce document à tout moment sans préavis. Veuillez consulter [www.eg4electronics.com](http://www.eg4electronics.com) pour la version la plus récente de nos manuels/fiches techniques.

## 5. BRIEF INTRODUCTION

This is a multi-function inverter/charger, combining the capabilities of an inverter, MPPT solar charger, and battery charger to offer uninterrupted power support in a portable size. Its comprehensive LCD display offers user-configurable and easy-accessible button operation including: battery charging current, AC/solar charger priority, and acceptable input voltage based on different applications.

### 5.1 INVERTER FEATURES

- Pure sine wave inverter
- Built-in MPPT solar controller
- Configurable input voltage range for home appliances and personal computers
- Configurable battery charging current based on applications
- Configurable AC or Solar charging priority
- Compatible with utility or generator power
- Auto restart when AC input is restored
- Overload/Over temperature/Short circuit protection
- Smart battery charger design for optimized battery performance

### 5.2 BASIC SYSTEM ARCHITECTURE

The following illustration shows a basic Energy Storage System (ESS) architecture utilizing the EG4 3000EHV Inverter/Charger. A wide variety of appliances in the home or office environment can be powered using this inverter/charger, including compressor-based appliances such as a refrigerator or air conditioner. Consult with your system integrator for other possible system architectures depending on your requirements.

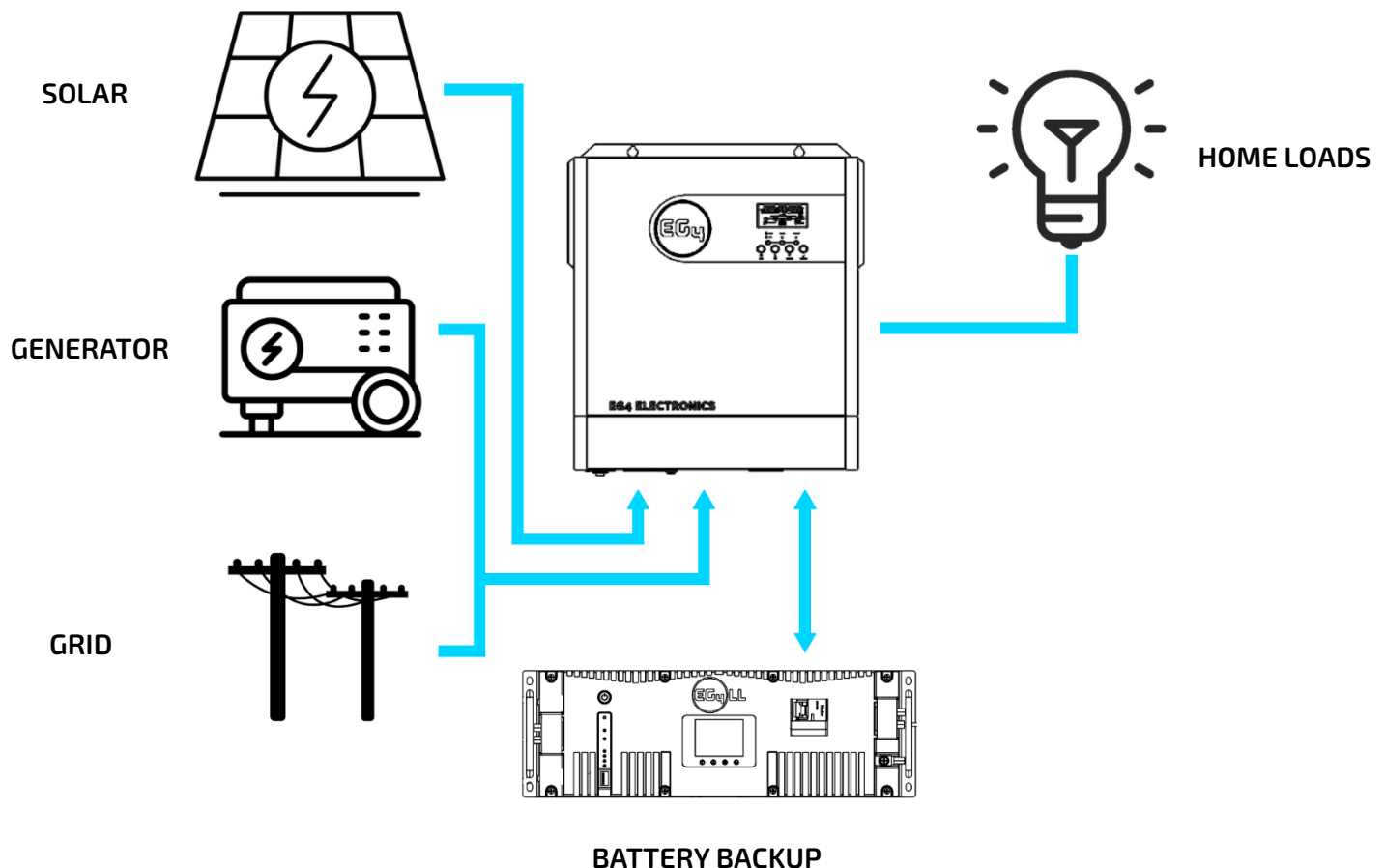

## 5.3 PRODUCT OVERVIEW

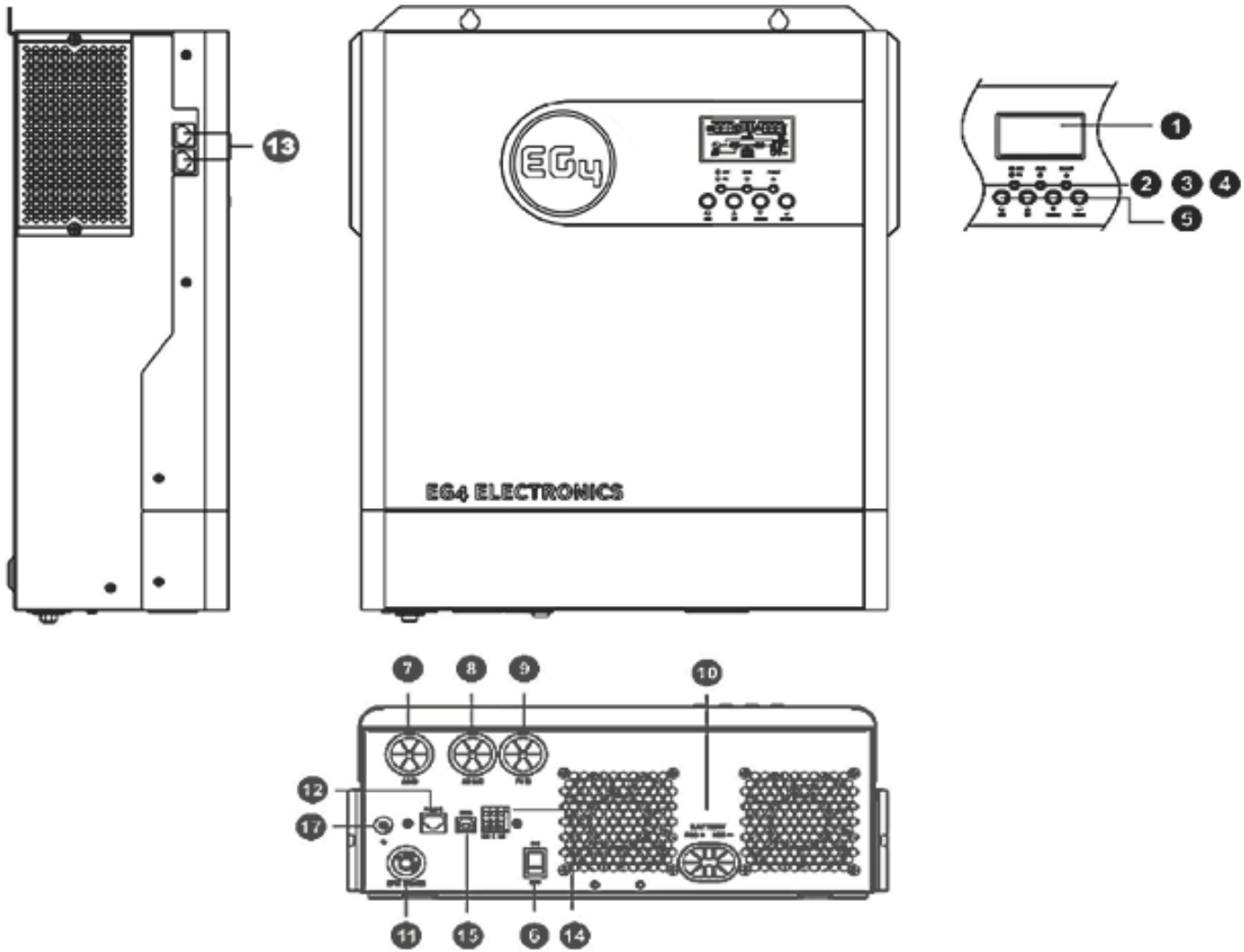

No.	Description	No.	Description
1	LCD Display	9	PV Input (500VDC Max.)
2	Status Indicator	10	Battery Input (48VDC Nominal)
3	Charging Indicator	11	AC Input Circuit Breaker
4	Fault Indicator	12	RS232 Communication Port for Wi-Fi Comms
5	Function Buttons	13	Parallel Communication Port
6	Power On/Off Switch	14	Dry Contacts
7	AC Input (Line/Neutral)	15(*)	USB Communication Port for PC Applications OR RS485 BMS Communication Port
8	AC Output (Line/Neutral)	17(*)	Grounding Screw

(\*) 16 is intentionally omitted from this table.

## 6. INSTALLATION

### 6.1 PACKAGING LIST AND PLACEMENT

When the product is unpacked, the contents should match those listed below:

- EG4 3000EHV inverter
- User manual
- Battery BMS Cable
- 125A DC Breaker
- 6" DIN Rail
- 6' Red and Black 4AWG Battery Cable
- Wi-Fi Communications Module
- 5' RJ11 to DB9 male RS232 Cable
- 4' RJ45 Patch Cable
- 3' RS485 to USB Upgrade Cable

### 6.2 LOCATION SELECTION AND INSTALLATION

#### 6.2.1 REQUIREMENTS FOR INSTALLATION LOCATION

The inverter is designed to be wall-mounted and should be installed on a vertical, solid mounting surface such as brick, concrete, or other **non-combustible** material. Two or more people may be needed to install the inverter due to its weight and size. The mounting wall should be strong enough to bear the weight of the inverter. Never position the inverter in direct sunlight and protect the LCD screen from excessive UV exposure.

#### 6.2.2 PREPARATION

Before connecting all wiring, please remove the bottom cover by removing the two screws as shown below.

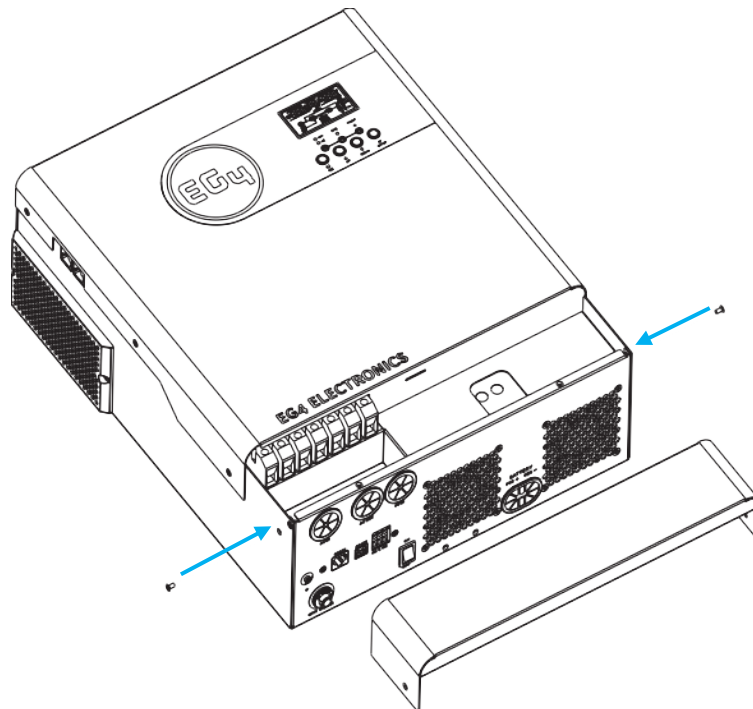

## 6.2.3 INSTALLING THE INVERTER

Consider the following points before selecting an indoor location for installation:

- Do not mount the inverter on flammable construction materials
- Mount vertically on a solid vertical surface or wall.
- Install this inverter at eye level to allow the LCD display to be visible at all times.
- The ambient temperature should be between 0°C to 55°C (-15°F to 131°F) to ensure optimal operation.
- No mounting hardware is provided with this inverter. Select mounting hardware suitable for the mounting surface and the weight of the inverter (e.g., concrete anchors, wood screws, lag bolts, etc.)
- Be sure to distance other objects and surfaces as shown in the diagram to the right to guarantee sufficient heat dissipation and to have enough space for cabling the inverter.

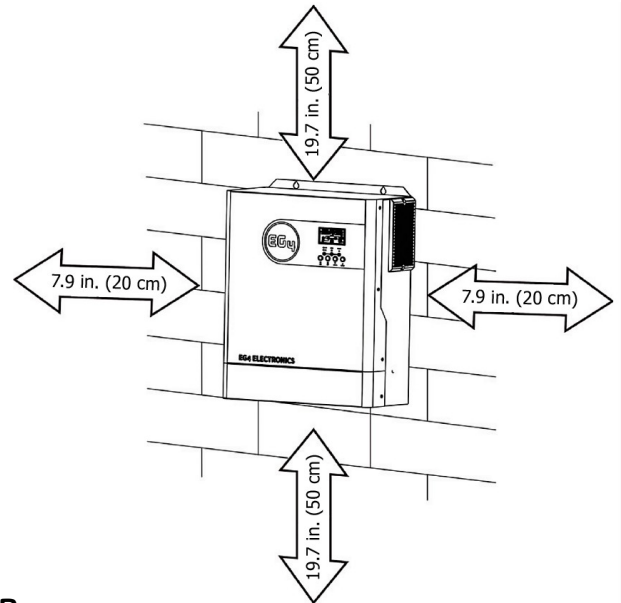

### SUITABLE FOR INDOOR MOUNTING ON CONCRETE OR OTHER NON-COMBUSTIBLE SURFACES ONLY

1. Identify where the inverter's final placement will be.
2. Mark the spot where the top left mounting hole will be.
3. Using a ruled level, measure ~7.9 in. (20cm) to the right and mark where the top right mounting hole will be.
4. Install the mounting hardware on the wall where the top left and right mounting holes are marked.
5. Using team lift, place the inverter's top two mounting holes over the top two mounting screws and let the weight of the inverter rest on the top two mounting screws.
6. Make sure the inverter is level and mark the spot where the bottom mounting hole will be.
7. Using team lift, remove the inverter from the wall and install the bottom mounting screw.
8. Using team lift, install the inverter on the three mounting screws. Make any final adjustments to level the inverter and tighten all three mounting screws to secure the inverter to the wall.

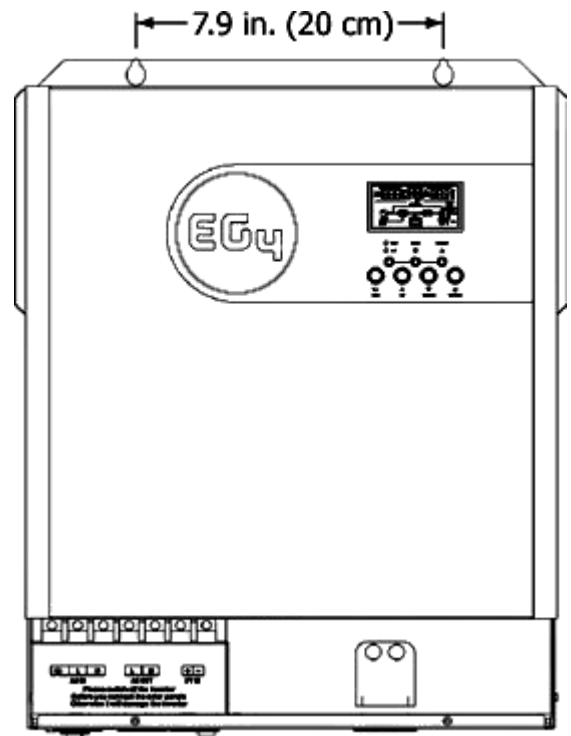

## 6.3 PV CONNECTION



**CAUTION:** Before connecting to PV modules, please install a separate DC circuit breaker between the inverter and PV modules.

We recommend all wiring be performed by a licensed professional. It is very important for system safety and efficient operation to use appropriate cable for PV module connection. To reduce risk of injury, please use the proper recommended cable size as shown below.

### 6.3.1 CONNECTING PV TO THE INVERTER

Model	Maximum Current	Cable Size*	Torque
3000EHV-48	18A	10 AWG up to 50'/15.2m	1.4~1.6 Nm

Solar Charging Mode	
Inverter Model	3000EHV-48
Max. PV Array Open Circuit Voltage	500VDC
PV Array MPPT Voltage Range	120VDC~450VDC



**NOTE:** Do not operate inverter with only PV input to run loads. Either the addition of grid power, battery power or both is required for powering loads.



**EXAMPLE:** Using a 330W PV module and considering the 3 system parameters below – the recommended module configurations would be as follows:

Solar Panel Specifications	Solar Input	Quantity of Panels	Total Input Power	Inverter Model
	Min. in series: 5 pcs, Max. in series: 10 pcs			
<b>Voc – 40.35VDC</b>  <b>Vmp – 33.25VDC</b>  <b>Imp – 9.925A</b>  <b>Isc – 10.79A</b>	6 pcs in series	6 pcs	1980W	3000EHV-48
	8 pcs in series	8 pcs	2640W	3000EHV-48
	10 pcs in series	10 pcs	3300W	3000EHV-48
	6 pieces in series and 2 sets in parallel	12 pcs	3960W	3000EHV-48
	8 pieces in series and 2 sets in parallel	16 pcs	5280W	3000EHV-48

\*Assuming 10% voltage drop free air

\*\*VOC max @ -25C/-14°F = 46.6Vdc and Vmp min @ 40°C/104F Ground mount = 27.5VDC



**IMPORTANT:** The table above is for example purposes only. Please use a string sizing calculator or contact a licensed professional for exact sizing measurements.

## 6.3.2 PV SYSTEM PARAMETERS

When selecting proper PV modules, please be sure to consider the following parameters:

1. Temperature adjusted open circuit voltage (VOC) of the solar panels must not exceed maximum MPPT open circuit voltage (VOC).
2. Temperature adjusted voltage at minimum power (VMP) of the solar panels should be higher than the start-up voltage of the inverter.
3. Calculate the panel configuration for the specific location and panel specifications.

## 6.3.3 PV MODULE WIRE CONNECTION

Please follow the steps below to implement PV module connection:

1. Remove 10 mm/0.4" of the insulation sleeve from the positive and negative conductors.
2. Check the polarity of the connection cables from the PV modules and PV input connectors.
3. Using a flat-head screwdriver, insert the head of the driver into the release slot above the connection terminal at a ~90° angle until it is snug. Next, lift the screwdriver handle up to engage the release of the terminal. Insert the positive wire (+) and reset the screwdriver position to lock the connection in place. Repeat this process for the negative wire (-). Give the wires a light tug to ensure the connection is secure.

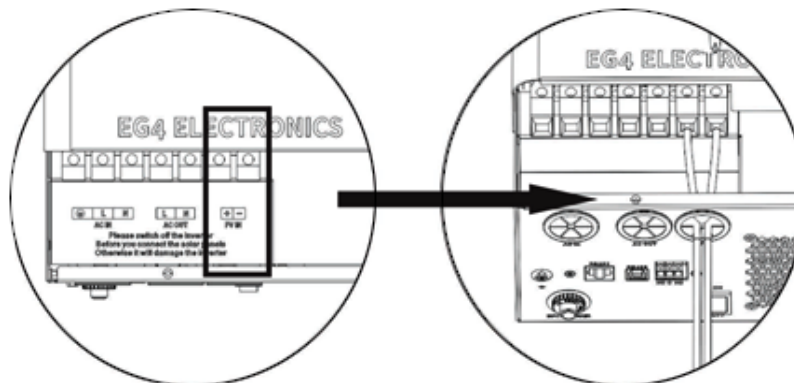
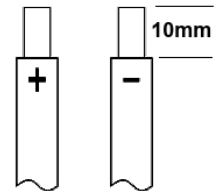

## 6.4 BATTERY CONNECTION



**CAUTION:** For safe operation and regulation compliance, it is recommended that a separate DC over-current protection or disconnect device is installed between battery and inverter. Please refer to typical amperage listed below for required fuse or breaker size.



**WARNING!** It is very important for system safety and efficient operation to use the appropriate cable size for battery connection. To reduce risk of injury, please use the recommended cable and stripping length shown in the table below. See image below for visual representation.

Battery connection information:

Model	Maximum Amperage	Battery Capacity	Wire Size AWG/mm <sup>2</sup>	Recommended Wire Length	Torque value
3000EHV-48	80A	100AH	4AWG/25	6'/1.8m up to 15'/4.6m	2~ 3 Nm



**NOTE:** EG4 recommends all wiring to be performed by a licensed professional.

Please adhere to the steps below to implement the battery connections:

1. Remove 18mm of the insulation sleeve from the positive and negative battery cables as shown to the right.
2. Connect all battery packs as unit requires, and use recommended battery capacity.
3. Insert battery cable to the battery connector of inverter and make sure the bolts are tightened with torque of 2-3 Nm. Make sure polarity at both the battery and the inverter/charge is correctly connected and battery cables are tightly screwed to the battery connector.

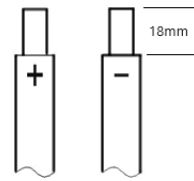

**Please Note:** Maximum current drawn by the inverter is 80A. If using EG4 Batteries, the maximum output is 100A. One 125A breaker is recommended to support a maximum battery current of 100A. If using batteries other than EG4, please consult the manufacturer's manual to ensure proper breaker size.

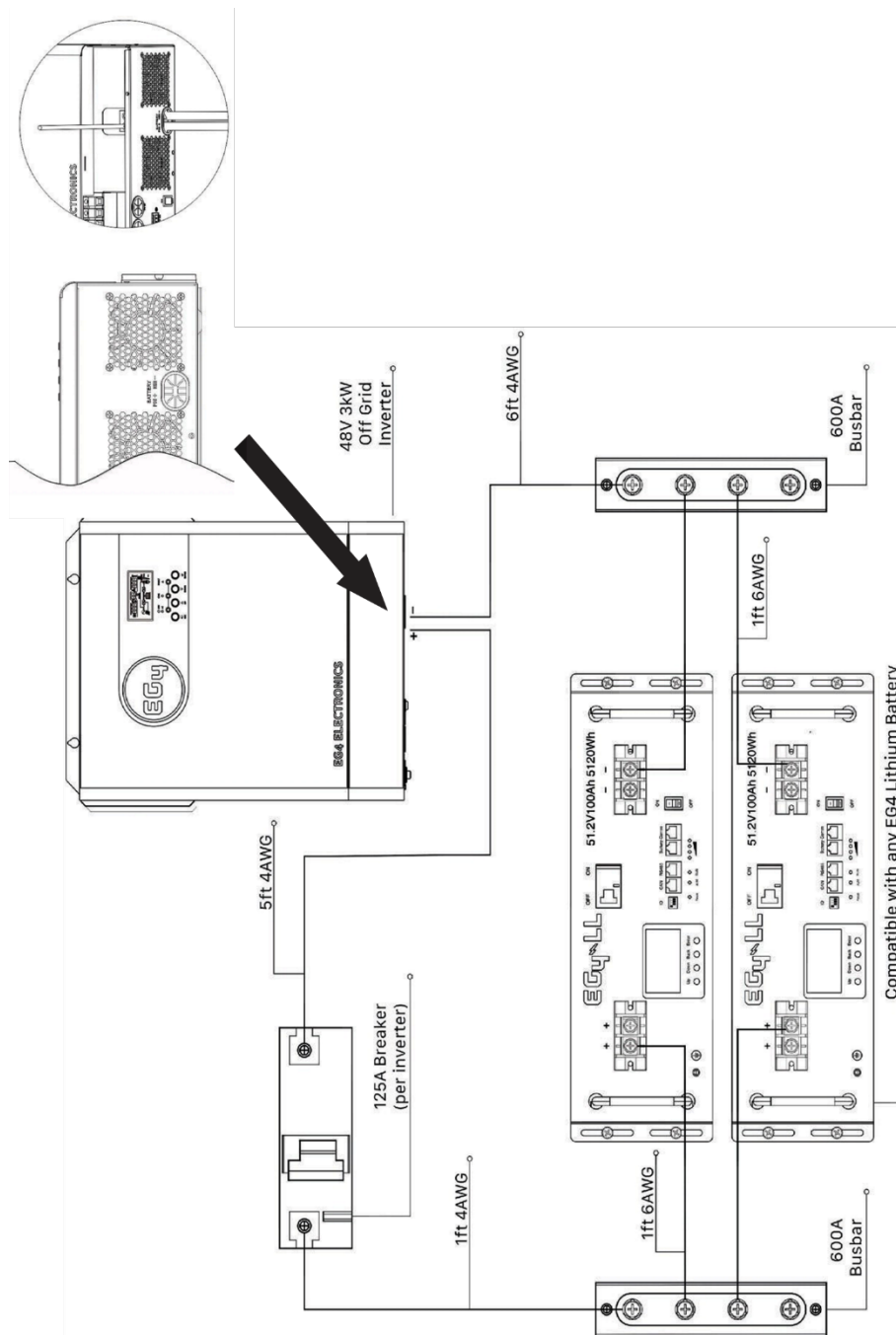

## CAUTION!

Installation must be performed with extreme care due to high battery voltage.

- Do not place anything between the flat part of the inverter terminal blocks as overheating may occur.
- Do not apply antioxidant substances on the terminals before terminals are secured.
- Before making the final DC connections, or closing the DC breaker/disconnect, ensure positive (+) is connected to positive terminal is negative (-) is connected to negative terminal.



## CAUTION!

- Before connecting to AC input power source, please install a separate AC breaker between inverter and AC input power source. This will ensure the inverter can be securely disconnected during maintenance and fully protected from AC input over current. Recommended specification of AC breaker is 30A on the input and 30A on the output.
- There are two terminal blocks with “IN” and “OUT” markings. Please do NOT misconnect input and output connectors.

## 6.5 AC INPUT/OUTPUT CONNECTION



### IMPORTANT:

The inverter has an internal neutral ground bonding screw preinstalled. Removing the internal bonding screw will not void the product warranty.



### REMINDER:

EG4 recommends all wiring be performed by a licensed professional.



### WARNING:

It is very important for system safety and efficient operation to use appropriately sized cable for AC connections. To reduce the risk of injury, please use the recommended cable sizes shown below.

#### Suggested cable requirement for AC wires

Model	Gauge*	Torque Value	AC Breaker
3000EHV-48	10AWG up to 32'/16.5m	1.4~ 1.6Nm	30A Input/30A Output

\*120V system, 3% max drop, assuming open air. AC output is 25A.

Please follow the steps below to implement AC input/output connections:

1. Before making AC input/output connection, be sure to open (turn off) the DC protector or disconnect FIRST.
2. Remove insulation sleeve 10mm for six conductors. Shorten phase (L) and neutral conductor (N) by 3 mm.
3. Insert AC input wires according to polarities indicated on terminal block and tighten the terminal screws. Be sure to connect the ground (PE) conductor (⊕) first.

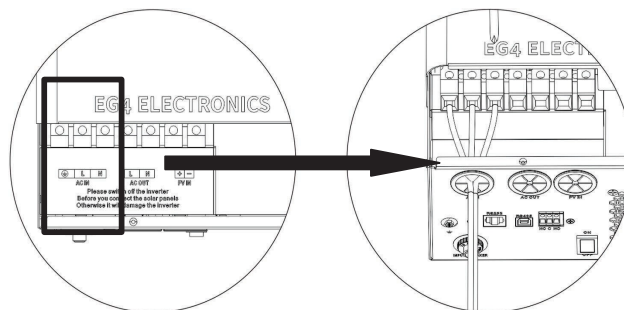



## WARNING:

Ensure the AC power source is disconnected before attempting to hardwire into the unit.

4. Then, insert AC output wires according to polarities indicated on terminal block and tighten terminal screws. Be sure to connect the ground (PE) conductor (⊕) first.

⊕ **Ground (Green or Green with Yellow stripe)**  
L→**LINE(Black for Line 1)(Red for Line 2 in 120/240 split-phase configuration)**  
N→**Neutral (White or Gray)**  
**NOTE: Wire colors may vary.**

5. Make sure the wires are securely connected.



## IMPORTANT:

The inverter has an internal neutral ground bonding screw preinstalled. Removing the internal bonding screw will not void the product warranty.

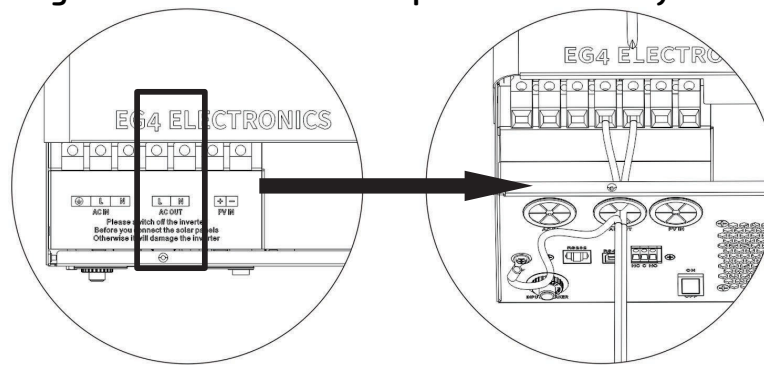

## CAUTION:

- Be sure to connect the AC wires with correct polarity. If L and N wires are reversed, it may cause a utility short-circuit when the inverters are in parallel operation.
- Appliances such as air conditioners require at least 2-3 minutes to restart to have enough time to balance the refrigerant gas. If a power outage occurs and recovers in a short time, it may cause damage to the other connected appliances. To prevent this damage, please check the appliance manufacturer's documentation for time-delay start function before installation. The inverter/charger will trigger overload fault and cut off the output to protect the appliances which may cause internal damage to the appliances.

## 6.6 FINAL ASSEMBLY

After connecting all wiring, please put bottom cover back by screwing in the two screws as shown below.

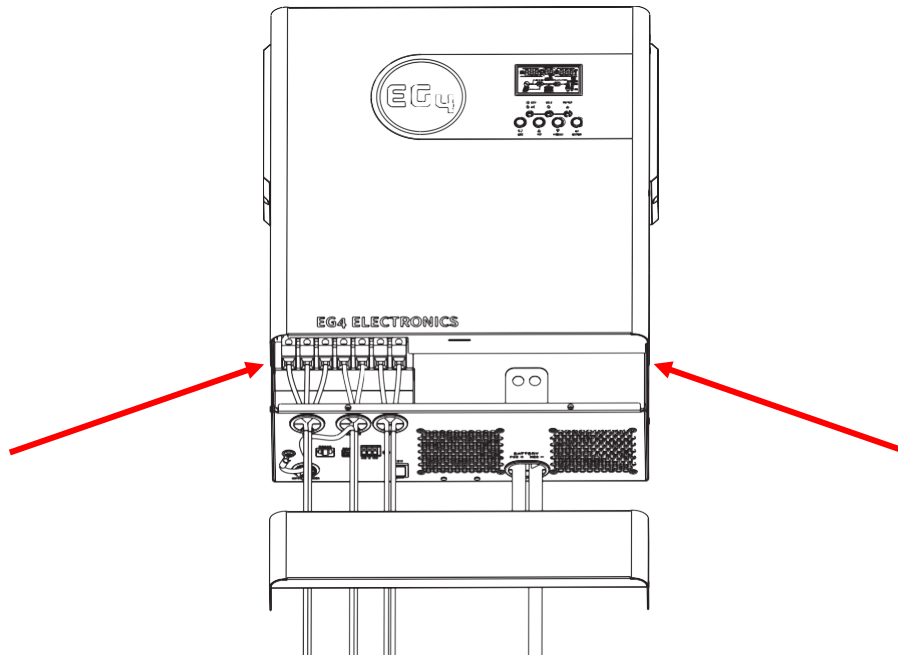

## 7. OPERATION GUIDE

### 7.1 DRY CONTACT SIGNAL

There is one dry contact (3A/250VAC) available on the rear panel which can be used to deliver signal to an external device when battery voltage reaches warning level.

Unit Status	Condition		Dry Contact Port:		
			NC & C	NO & C	
Power Off	Unit is off and no output is powered.		Close	Open	
	Output is powered from Utility.		Close	Open	
Power On	Output is powered from Battery or Solar.	Program 01 set as Utility	Battery voltage < Low DC warning voltage	Open	Close
			Battery voltage > Setting value in Program 13 or battery charging reaches floating stage	Close	Open
	Program 01 is set as SBU or SUB or Solar first	Battery voltage < Setting value in Program 12	Open	Close	
		Battery voltage > Setting value in Program 13 or battery charging reaches floating stage	Close	Open	

## 7.2 START-UP & SHUTDOWN PROCEDURES

### STARTING UP THE INVERTER

1. If using an external DC breaker between the battery bank and the inverter, turn it on. If not, close (turn on) external battery breakers, power on the batteries, starting with the master, one at a time and then press the ON/OFF switch located on the bottom of the inverter (see image to the right) to turn the unit ON.
2. Make sure the PV voltages of the strings are within operating parameters (120 – 450 VDC). Turn on the PV isolator switches between the inverter and array (if installed).
3. Make sure Steps 1 and 2 are running properly and then turn on the grid power breaker.
4. Ensure that the inverter shows “normal” operations on the LCD display on the front of the inverter.
5. Power on the load breakers in the load panel.

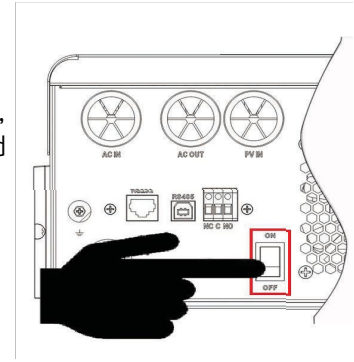

### SHUTTING DOWN THE INVERTER

1. Switch off the load breaker.
2. Turn off the grid breaker feeding the inverter.
3. Turn off the PV disconnect and then the battery breaker(s). Wait for the LEDs on the front of the unit to go off.

## 7.3 LCD DISPLAY

Running status, real-time power, and daily/accumulated energy information can all be conveniently viewed on the inverter's LCD screen. Additionally, users can also check the alarm and fault record on the display for troubleshooting.

The operation and display panel, shown in the diagram below, is on the front panel of the inverter. It includes three indicators, four function keys, and an LCD display which indicates the operating status, input/output power information, and alarm/fault record information.

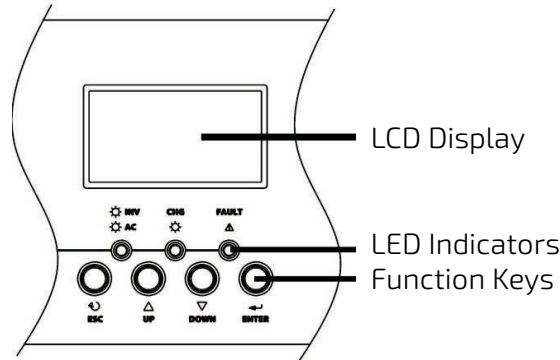

### 7.3.1 LED INDICATOR

LED Indicator		Messages	
☀️ AC / ☀️ INV	Green	Solid On	Output is powered by utility in Line mode.
		Flashing	Output is powered by battery or PV in battery mode.
☀️ CHG	Green	Solid On	Battery is fully charged.
		Flashing	Battery is charging.
⚠️ FAULT	Red	Solid On	Fault occurred in the inverter.
		Flashing	Warning condition occurred in the inverter.

### 7.3.2 FUNCTION KEYS





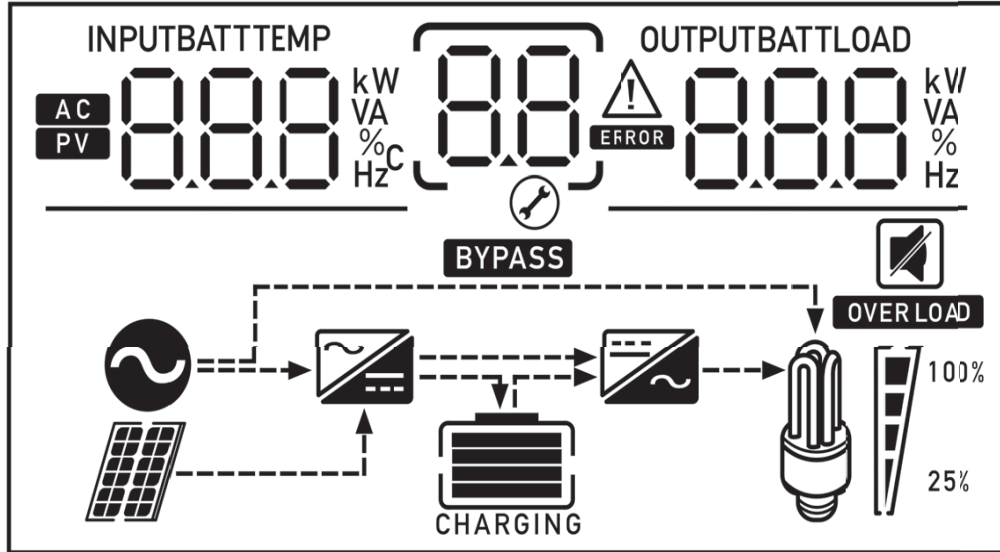





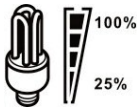

Function Key	Description
ESC	To exit setting mode
UP	To go to previous selection
DOWN	To go to next selection
ENTER	To confirm the selection in setting mode or to enter setting mode

## 7.3.3 LCD DISPLAY ICONS



The table on the following page provides a description of the icons in the LDC Display.



Icon	Function Description
<b>Input Source Information</b>	
<b>AC</b>	Indicates the AC input.
<b>PV</b>	Indicates the PV input
<b>INPUTBATT</b> 8888 kW VA %C Hz	Indicate input voltage, input frequency, PV voltage, battery voltage and charger current.
<b>Configuration Program and Fault Information</b>	
88 ⚙️	Indicates the program settings
Indicates the warning and fault codes.	
88 ⚠️ ERROR	Warning: 88 ⚠️ flashes the warning code.
88 ERROR	Fault: 88 ERROR lights the fault code

Output Information				
	Indicates the output voltage, output frequency, load percentage, load in VA, load in Watt and discharge current.			
Battery Information				
	Indicates battery level: 0-24%, 25-49%, 50-74% and 75-100% for each bar in battery mode and charging status in line mode.			
Load Information				
	Indicates overload.			
	Indicates the load level: 0-24%, 25-49%, 50-74% and 75-100%.			
	0%~24%	25%~49%	50%~74%	75%~100%
				
Mode Operation Information				
	Indicates unit is connected to the grid.			
	Indicates unit is connected to the PV panel.			
	Indicates load is directly connected to the grid.			
	Indicates the utility charger circuit is operational.			
	Indicates the DC/AC inverter circuit is operational.			
Mute Operation				
	Indicates unit alarm is disabled.			

## 7.4 PROGRAM SETTINGS



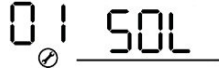

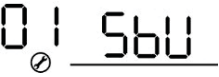
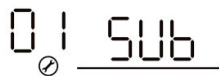











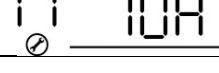



After pressing and holding the **ENTER** button for 3 seconds, the unit will enter setting mode. Press **UP** or **DOWN** button to select setting programs. Then, press the **ENTER** button to confirm the selection or **ESC** button to exit.

## 7.4.1 PROGRAM SETTINGS

Program	Description	Selectable Option	
01	Output source priority: To configure load power source priority	<p>Solar first</p> 	<p>Solar energy provides power to the loads as top priority. If solar energy is not sufficient to power all connected loads, battery energy will supply power to the loads at the same time. Utility provides power to the loads only when one or all of the following conditions are in play:</p> <ul style="list-style-type: none"> <li>Solar energy is not available.</li> <li>Battery voltage drops to either low-level warning voltage or the setting point in <i>Program 12</i>.</li> </ul>
		<p>Utility first (default)</p> 	<p>Utility will provide power to the loads as top priority. Solar and battery energy will provide power to the loads only when utility power is not available.</p>
		<p>SBU priority</p> 	<p>Solar energy provides power to the loads as top priority. If solar energy is not sufficient to power all connected loads, battery energy will supply power to the loads at the same time. Utility provides power to the loads only when battery voltage drops to either low-level warning voltage or the setting point in program 12.</p>
		<p>SUB priority</p> 	<p>Solar energy provides power to the loads as top priority. If solar energy is not sufficient to power all connected loads, utility energy will supply power to the loads at the same time.</p>

02	Maximum charging current: Configures the total charging current for solar and utility chargers. (Max. charging current = utility charging current + solar charging current)	10A 02 10 <sup>A</sup>	20A 02 20 <sup>A</sup>		
		30A 02 30 <sup>A</sup>	40A 02 40 <sup>A</sup>		
		50A 02 50 <sup>A</sup>	60A (default) 02 60 <sup>A</sup>		
		70A 02 70 <sup>A</sup>	80A 02 80 <sup>A</sup>		
		03	AC input voltage range	Appliances (default) 03 APL	If selected, acceptable AC input voltage range will be within 70-160VAC.
				UPS 03 UPS	If selected, acceptable AC input voltage range will be within 80-160VAC.
				Generator <b>Note:</b> Setting available with <u>optional</u> firmware update if unit is not already equipped. 03 GNT	If selected, the acceptable AC input voltage range will be within 70-160VAC and compatible with generators. <b>Note:</b> Because generators output is unstable, the output of the inverter may be unstable as well.







05	Battery Type	05 <u>AGn</u>	AGM (default)
		05 <u>FLd</u>	Flooded
		05 <u>USE</u>	User-Defined
		05 <u>L1</u>	Customized Protocol
		05 <u>L2</u>	Customized Protocol
		05 <u>L3</u>	Customized Protocol
		05 <u>L4</u>	EG4 Battery Protocol
		05 <u>L5</u>	Customized Protocol
06	Auto restart when overload occurs	Restart disable (default) 06 <u>LFD</u>	Restart enable 06 <u>LFE</u>
07	Auto restart when over temperature occurs	Restart disable (default) 07 <u>TFD</u>	Restart enable 07 <u>TFE</u>
08	Output voltage	110V 08 <u>110</u> <sup>v</sup>	120V (default) 08 <u>120</u> <sup>v</sup>
		115V 08 <u>115</u> <sup>v</sup>	
09	Output frequency	50Hz (default) 09 <u>50</u> <sub>Hz</sub>	60Hz 09 <u>60</u> <sub>Hz</sub>
10	When 'auto' is selected the load will automatically bypass if utility is within the range defined by <i>Program 3</i>	manual(default) 10 <u>nNL</u>	auto 10 <u>ATO</u>

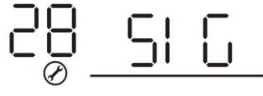

11	Maximum utility charging current	2A 	10A 
		20A 	30A (default) 
		40A 	50A 
		60A 	70A 
		80A 	
12	Point back to Utility: (Low battery voltage level that switches the load to utility if SOL or SBU priority has been set in Program 1)  <b>Please note: This is ONLY for AGM &amp; FLD battery types</b>	Point back to Utility: (Low battery voltage level setting range is from 44.0V to 57.2V for 48V model, switches the load to utility if SOL or SBU priority has been set in Program 1).	
		44V 	45V 
		46V (default) 	47V 
		48V 	49V 
		50V 	51V 
		52V 	53V 
		54V 	55V 

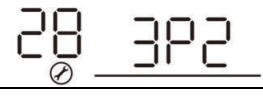
13	<p>Point back to Battery: (Charged battery voltage level that switches the load to battery if SOL or SBU priority has been set in Program 1)</p> <p><b>Please Note: This is ONLY for AGM &amp; FLD battery types</b></p>	<p>***Available options in 48V models: Setting range is from 48V to full (the value of program 26-0.4V), but the setting value must be more than the value of Program 12.</p>	
		Battery fully charged (default)	48V
		49V	50V
		51V	52V
		53V	54V
		55V	56V
57V	58V		
59V	60V		
61V	62V		

16	Charger source priority: <i>(To configure charger source priority)</i>	If this inverter/charger is working in Line, Standby or Fault mode, charger source can be programmed as below:	
		Solar first 16 <u>CS0</u>	Solar energy will charge battery as top priority. Utility will charge battery only when solar energy is not available.
		Utility first 16 <u>CUt</u>	Utility will charge battery as top priority. Solar energy will charge battery only when utility power is not available.
		Solar and Utility (default) 16 <u>SNU</u>	Solar energy and utility will charge battery at the same time.
		Only Solar 16 <u>OS0</u>	Solar energy will be the only charger source regardless of whether utility is available or not.
		If this inverter/charger is working in Battery mode only solar energy can charge battery. Solar energy will charge battery if it is available and sufficient.	
18	Buzzer Mode	Mode1 bU2 18 nd1	Buzzer mute
		Mode2 bU2 18 nd2	The buzzer sounds when the input source changes or there is a specific warning or fault
		Mode3 bU2 18 nd3	The buzzer sounds when there is a specific warning or fault
		Mode4(default) bU2 18 nd4	The buzzer sounds when there is a fault
19	Auto return to default display screen	Return to default display screen (default) 19 <u>ESP</u>	If selected, no matter how users switch display screen, it will automatically return to default display screen after 1 minute of inactivity.
		Stay at latest screen 19 <u>TEP</u>	If selected, the display screen will stay at last user-selected screen.
20	Backlight control	Backlight on (default) 20 <u>LON</u>	Backlight off 20 <u>LOF</u>

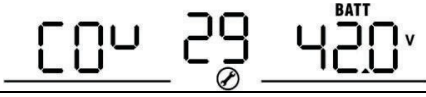
23	Overload bypass: <i>When enabled, the unit will transfer to line mode if overload occurs in battery mode.)</i>	Bypass disable (default) 23 BYD	Bypass enable 23 BYE
25	Modbus ID Setting	Modbus ID Setting Range :001(default)~247 n0d 25 001	
26	Bulk charging voltage (C.V. voltage)	48V models default setting: 56.4V CU 26 56.4 <sup>BATT</sup> v If self-defined is selected in program 5, this program can be set up. Setting range is from 48.0V to 62.0V for 48v model. But the setting value must be ≥ the value of program27. Increment of each click is 0.1V.	
27	Floating charging voltage	48V models default setting: 54.0V FLU 27 54.0 <sup>BATT</sup> v	

28	AC output mode (See <i>Parallel Installation Guide</i> in Section 7.8 for more details)	<p>Single: This inverter is used in single-phase application.</p> 	<p>Parallel: This inverter is operated in a single-phase parallel system. (Need hardware support)</p> 
		<p>L1 phase</p> 	<p>The inverter is operated in L1 phase in 3-phase application</p>
		<p>L2 phase</p> 	<p>The inverter is operated in L2 phase in 3-phase application</p>
		<p>L3 phase</p> 	<p>The inverter is operated in L3 phase in 3-phase application</p>
			<p>The inverter is operated in L1 phase in split-phase application</p>
			<p>The inverter is operated in L2 phase in split-phase application</p>
29	Low DC cut-off voltage	<p>48V models default setting: 42.0V</p> 	
		<p>If self-defined is selected in program 5, this program can be set up. Setting range is from 40.0V to 54.0V for 48V model. The setting value must be less than the value of program 12. Increment of each click is 0.1V. Low DC cut-off voltage will be fixed to setting value no matter what percentage of load is connected.</p>	

<p>30</p>	<p>PV judge condition: <i>(Only applies for setting "Solar first" in Program 1: Output source priority)</i></p>	<p>One Inverter (Default):</p> 	<p>When "ONE" is selected, as long as one of inverters has been connected to PV modules and PV input is normal, parallel, or 3-phase system will continue working according to rule of "solar first" setting.</p> <p><b>EXAMPLE:</b> If two units are connected in parallel and set to "SOL" in output source priority. Then if one of two units has connected to PV modules and PV input is normal, the parallel system will provide power to loads from solar or battery power. If both are not sufficient, the system will provide power to loads from utility.</p>
		<p>All of Inverters:</p> 	<p>When "ALL" is selected, parallel or 3- phase system will continue working according to rule of "solar first" setting only when all of inverters are connected to PV modules.</p> <p><b>EXAMPLE:</b> If two units are connected in parallel and set to "SOL" in output source priority. When selecting "ALL" in program 30, it is necessary to have all inverters connected to PV modules and the PV input normal to allow the system to provide power to loads from solar and/or battery power. Otherwise, the system will provide power to loads from utility.</p>

32	Bulk charging time (C.V stage)	Automatically (Default): 32 <u>AUT</u>	If selected, inverter will set the charging time automatically.
		5 min 32 <u>5</u>	The setting range is from 5 min to 900 min. Increment of each click is 5 min.
		900 min 32 <u>900</u>	
		If "USE" is selected in program 05, this program can be set up.	
33	Battery equalization	Battery equalization 33 <u>EEN</u>	Battery equalization disable (default) 33 <u>EdS</u>
		If "Flooded" or "User-Defined" is selected in program 05, this program can be set up.	
34	Battery equalization voltage	48V models default setting is 58.4V. Setting range is from 48V ~ 64V. Increment of each click is 0.1V. EV 34 <u>BATT 64.0</u> v	
35	Battery equalized time	60min (default) 35 <u>60</u>	Setting range is from 5min to 900min. Increment of each click is 5min.
36	Battery equalized timeout	120min (default) 36 <u>120</u>	Setting range is from 5min to 900 min. Increment of each click is 5 min.
37	Equalization interval	30days (default) 37 <u>30d</u>	Setting range is from 0 to 90 days. Increment of each click is 1 day
39	Equalization activated immediately	Enable 39 <u>AEN</u>	Disable (default) 39 <u>AdS</u>
		If equalization function is enabled in program 33, this program can be set up. If "Enable" is selected in this program, it is to activate battery equalization immediately and LCD main page will show "E9". If "Disable" is selected, it will cancel equalization function until next activated equalization time arrives based on program 37 setting. At this time, "E9" will not be shown in the LCD main page.	
43	Setting SOC point back to utility	43 <u>BAT 050</u> %	Default 50%, 20%~50% Settable
44	Setting SOC point back to battery	44 <u>BAT 095</u> %	Default 95%, 60%~100% Settable
45	Low DC cutoff SOC	45 <u>BAT 020</u> %	Default 20%, 5%~30% Settable

## 7.5 DISPLAY SETTING

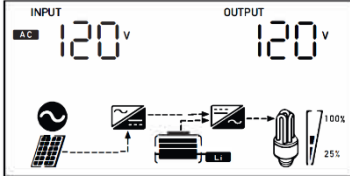
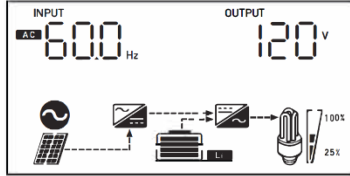
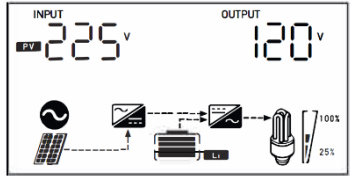
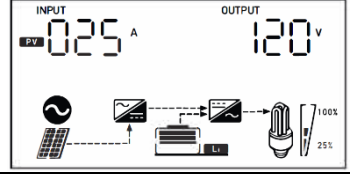
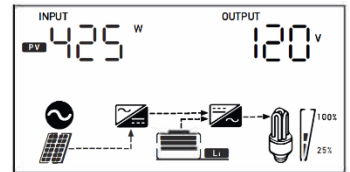

The LCD Display information can be switched by pressing the UP or DOWN key. The selectable information is switched in the following order: input/output voltage, input frequency, PV voltage, MPPT charging current, MPPT charging power, charging current, charging power, battery voltage, output voltage, output frequency, load percentage, load in VA, load in Watt, DC discharging current, main CPU Version and second CPU Version.

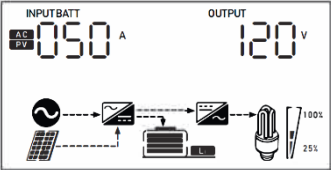
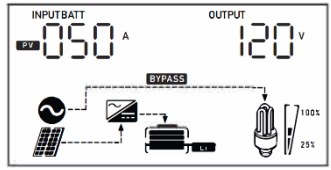
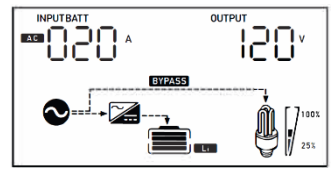
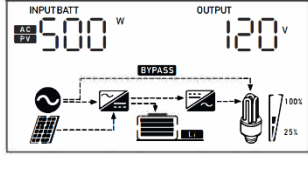
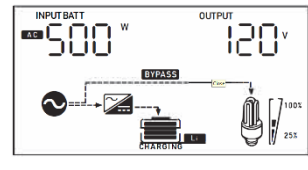
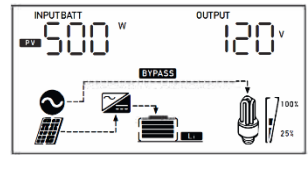
Application	Selectable Information	LCD Display
AC Input	Input Voltage/Output Voltage (Default Display Screen)	Input Voltage = 120V Output Voltage = 120V 
	Input Frequency	Input Frequency = 60Hz 
PV Input	PV Voltage	PV Voltage = 225V 
	MPPT Charging Current	Current $\geq 10A$ 
	MPPT Charging Power	MPPT Charging Power = 425W 

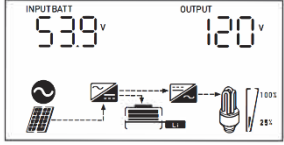
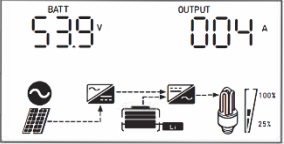

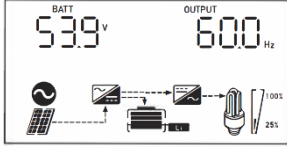
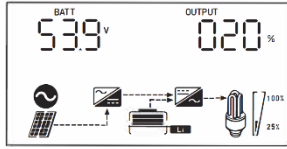
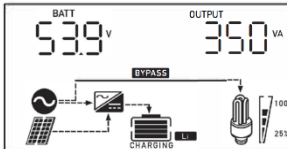
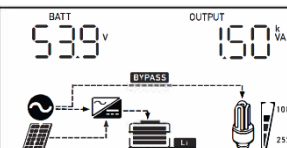
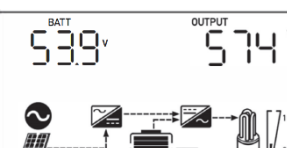
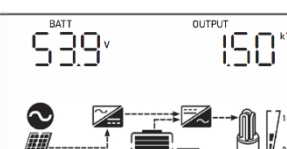
<p>PV/AC Charging</p>	<p>Charging Current</p>	<p>AC &amp; PV Charging Current = 50A</p>  <p>PV Charging Current = 50A</p>  <p>AC Charging Current = 20A</p> 
	<p>Charging Power</p>	<p>AC &amp; PV Charging Power = 500W</p>  <p>AC Charging Power = 500W</p>  <p>PV Charging Power = 500W</p> 

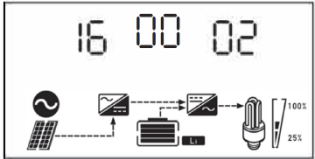

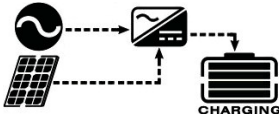
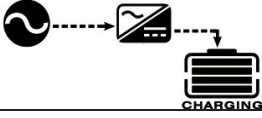

Battery Discharge	Output Voltage	Output Voltage = 120V 
	Output Current	Output Current = 4 A 

AC Output	Output Frequency	<p>Output Frequency = 60Hz</p> 
	Load Percentage	<p>Load Percentage = 20%</p> 
	Load in VA	<p>When connected load is lower than 1 kVA, load in VA will present as xxxVA as in the image below.</p>  <p>When connected load in larger than 1kVA, load in VA will present as x.xkVA as in image below.</p> 
	Load in Watt	<p>When load is lower than 1 kW, load in W will present as xxxW as in the image below.</p>  <p>When load in larger than 1kW, load in W will present as x.xkW as in image below.</p> 

System Specifications	Model Number	
	Firmware Version & Revision Number	

## 7.6 OPERATING MODE DESCRIPTION

Operation mode	Description	LCD display
Standby mode	No output is supplied by the unit but can still charge batteries.	Charging by utility and PV energy.
		
		Charging by utility.
		
		Charging by PV energy.
		
No charging.		

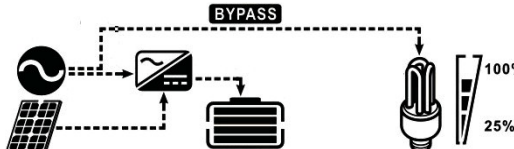
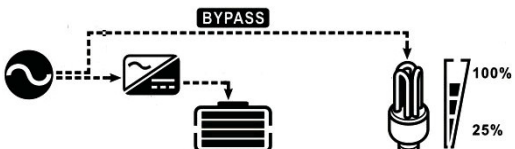
<p>Fault mode</p> <p><b>Note:</b> *Fault mode: Errors are caused by inside circuit error or external reasons such as over temperature, output short circuited and so on.</p>	<p>PV energy and utility can charge batteries.</p>	<p>Charging by utility and PV energy.</p> 
		<p>Charging by utility.</p> 
		<p>Charging by PV energy.</p> 
		<p>No charging.</p> 
<p>Line Mode</p>	<p>The unit will provide output power from the grid. It will also charge the battery at line mode.</p>	<p>Charging by utility and PV energy.</p> 
	<p>The unit will provide output power from the grid. It will also charge the battery at line mode.</p>	<p>Charging by utility.</p> 

Line Mode	<p>The unit will provide output power from the grid. It will also charge the battery at line mode.</p>	<p>If "solar first" is selected as the output source priority <b>and</b> solar energy is not sufficient to provide the load, then solar energy <b>and</b> utility will provide the loads as well as charge the battery at the same time.</p>
	<p>The unit will provide output power from the grid. It will also charge the battery at line mode.</p>	<p>If "SUB" is selected as the output source priority <b>and</b> the battery is connected, then solar energy will charge battery as top priority. If solar energy is sufficient for charging, solar <b>and</b> the utility will provide the loads.</p>
	<p>The unit will provide output power from the grid.</p>	<p>If "solar first" is selected as the output source priority <b>and</b> the battery is not connected, then solar energy <b>and</b> the utility will provide the loads.</p>
Battery Mode	<p>The unit will provide output power from battery and PV power.</p>	<p>Power from utility.</p>
		<p>Power from battery and PV energy.</p>
		<p>PV energy will supply power to the loads and charge battery at the same time</p>
		<p>Power from battery only.</p>
		<p>Power from PV energy only.</p>

## 7.7 TYPICAL APPLICATIONS

### 7.7.1 120V SINGLE PHASE IN PARALLEL

For loads requiring 120V, up to twelve 3000EHV-48's can be set up in parallel.

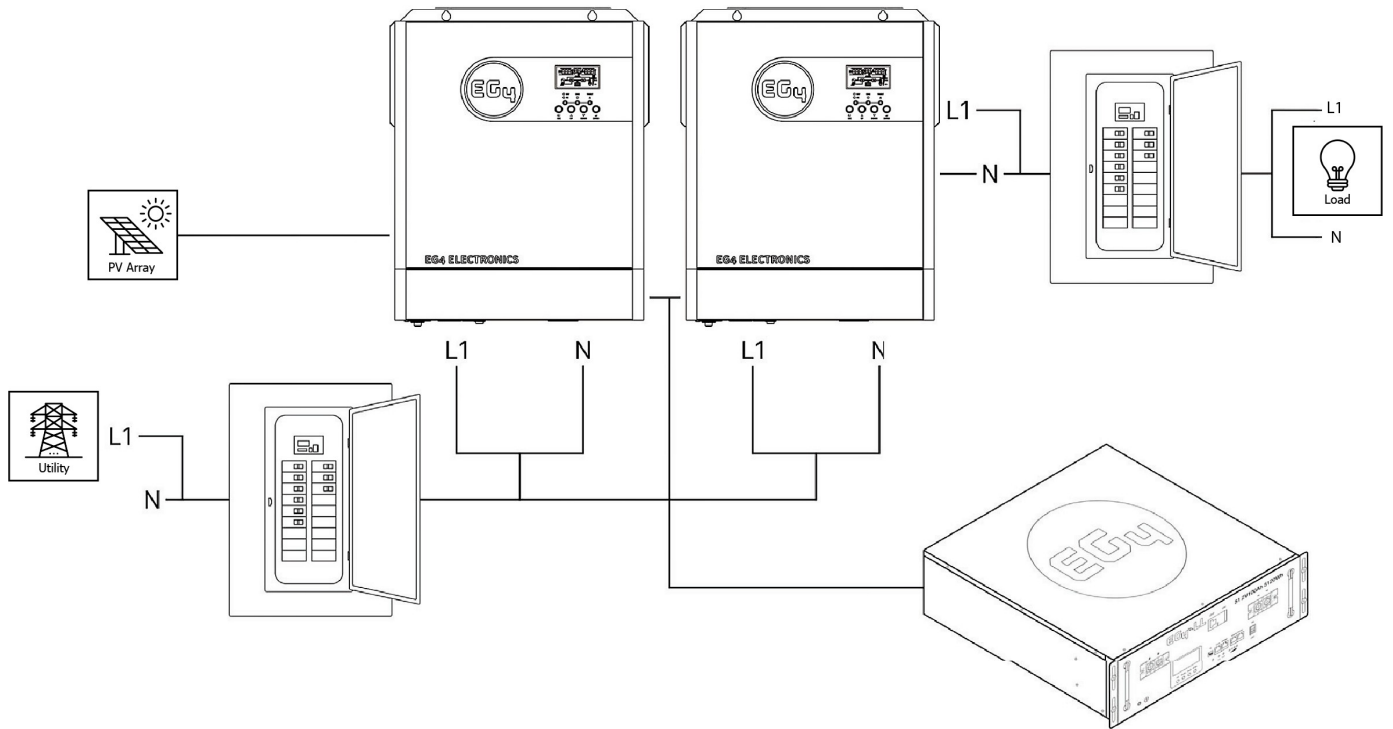

## 7.7.2 240/120V SPLIT-PHASE IN PARALLEL

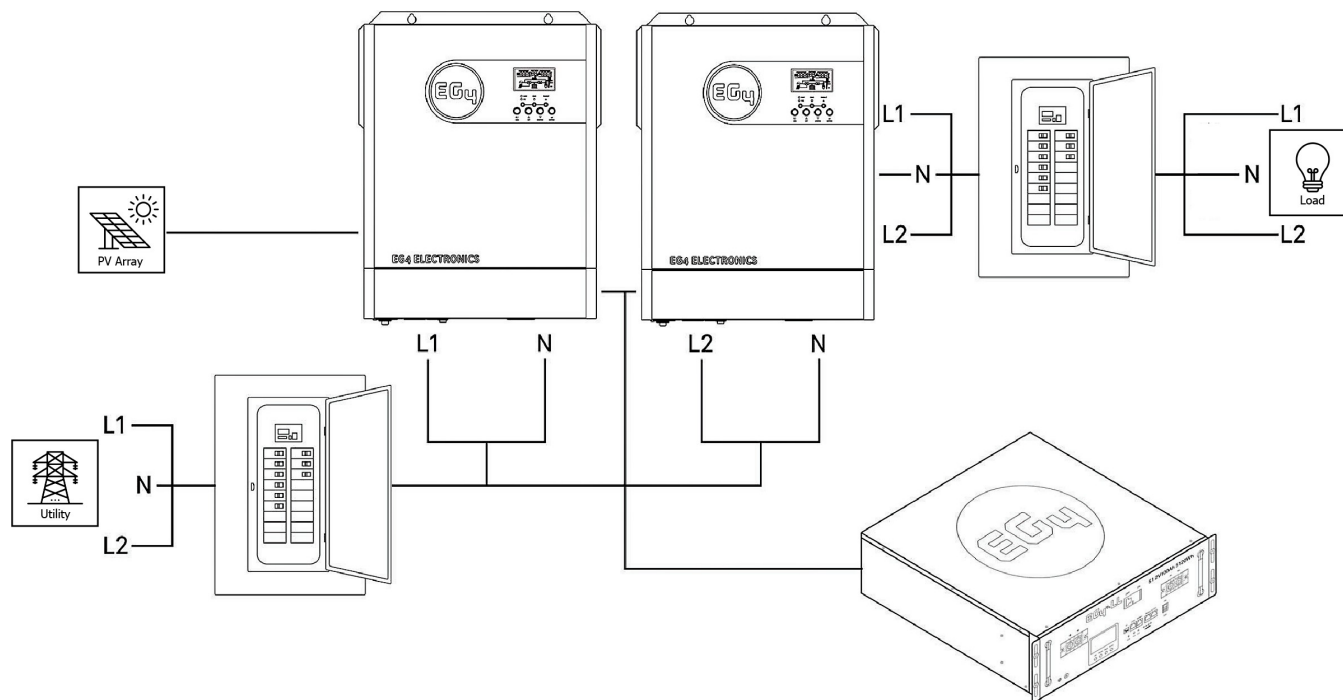

For loads requiring both 120V & 240V, up to six 3000EHV-48's per phase can be set up in parallel.

## 7.8 PARALLEL INSTALLATION GUIDE

### 7.8.1 INSTRUCTIONS

This inverter can be used in parallel with three different operation modes.

1. **Parallel Operation in Single Phase** - up to 12 units. The supported maximum output power is 36KW/36KVA.
2. **Parallel Operation in Three Phase** - Maximum 12 units work together to support three- phase equipment. 10 units support one phase maximum. The supported maximum output power is 36KW/36KVA and one phase can be up to 30KW/30KVA.
3. **Parallel Operation in Split-Phase** - up to 6 units per phase.

**NOTE:** If this unit is bundled with a parallel cable - the inverter's default operation mode is set to **parallel operation**.

## 7.8.2 PACKAGE CONTENTS

In the parallel kit, you will find the following items:

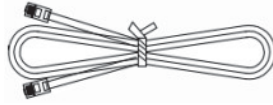

(1) Parallel communication cable

## 7.8.3 MOUNTING THE UNIT

When installing multiple units, please follow the chart below.

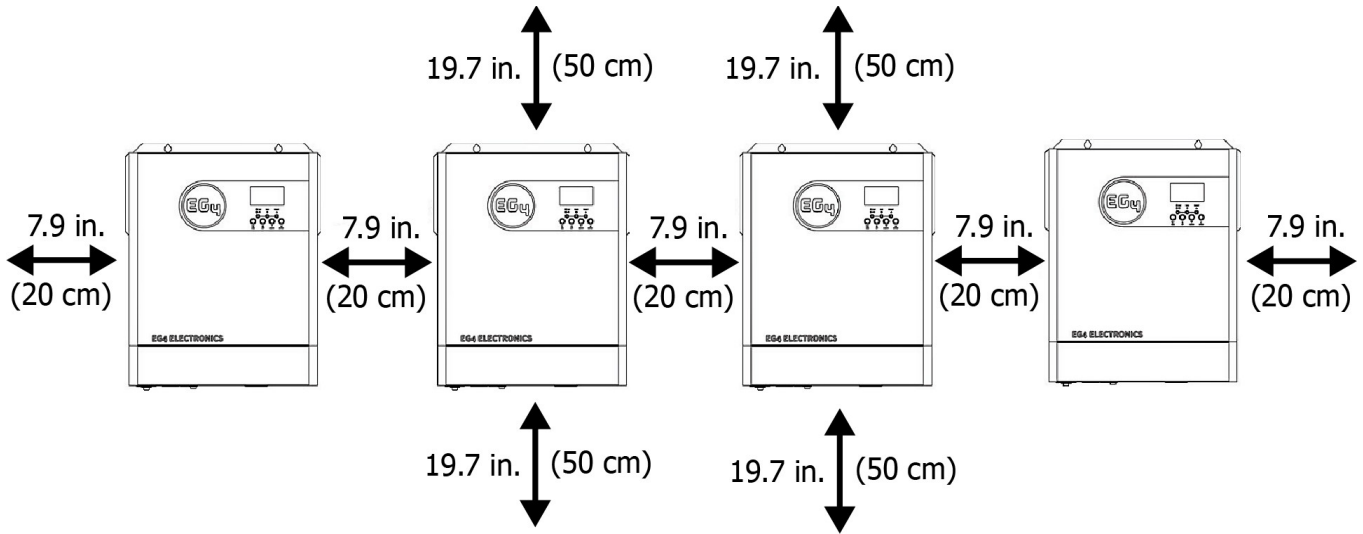

**NOTE:** For proper air circulation and heat dissipation, allow a clearance of approx. 20 cm/7.9" to the side and approx. 50 cm/19.7" above and below the unit. Be sure to install each unit at the same level.

## 7.8.4 WIRING CONNECTION



**WARNING:** Be sure the length of all battery cables is the same. Inconsistent battery cable lengths will cause inconsistent voltage readings between inverter and battery, which could result in nonworking parallel inverters.

Recommended battery cable specifications for each inverter (see section 6.4 for more details):

Model	Maximum Amperage	Battery Capacity	Wire Size AWG/mm <sup>2</sup>	Recommended Wire Length	Torque value
3000EHV-48	80A	100AH	4AWG/25	6'/1.8m up to 15'/4.6m	2~ 3 Nm

Recommended AC input and output cable specifications for each inverter:

Model	Gauge	Torque Value	AC Breaker
3000EHV-48	10AWG up to 32'/9.75m	1.4~ 1.6Nm	30A Input/30A Output

**Note** - Connect inverters and batteries to a properly sized busbar(s)



**CAUTION!!** Please install a breaker between the battery and inverter and on the AC input side. This will ensure the inverter can be securely disconnected during maintenance and fully protected from over current. The recommended mounting location of the breakers is shown in the figures on the following pages:

**Recommended Breaker Size Between Batteries & Inverter is 125 Amps regardless of system size.**

**Recommended main panel breaker specification of AC input with single phase:**

1st Panel	up to 2 units	3 units	4 - 5 units	2nd Panel	up to 2 units	3 units	4 - 5 units
3000EHV-48	60A	90A	150A	3000EHV-48	60A	90A	150A

**Recommended battery capacity** - additional batteries required for larger storage capacities.

Inverters in parallel	2	3	4	5	6	7	8	9	10	11	12
Battery Capacity	300Ah	400Ah	500Ah	600Ah	800Ah	900Ah	1000Ah	1100Ah	1200Ah	1300Ah	1500Ah



**WARNING!** Be sure that all inverters share the same battery bank. Otherwise, the inverters will transfer to fault mode.

## 7.9 COMMUNICATING WITH BATTERY BMS IN PARALLEL SYSTEM

1. Only supports common battery-type installation
2. Use RJ45 to USB-A cable to connect any one inverter in the paralleled system to your Lithium battery

Set Master inverter battery type to “LI X” in LCD program 5. All other inverters should be set to default value “AGM”.

\*\* "X" = Battery Communication Protocol Number.

For **EG4** batteries, set to **Li4**.

**Note:** Make sure only one inverter is connected via RJ45 to USB-A cable and set as Lithium in LCD program 5 and all others set to AGM.

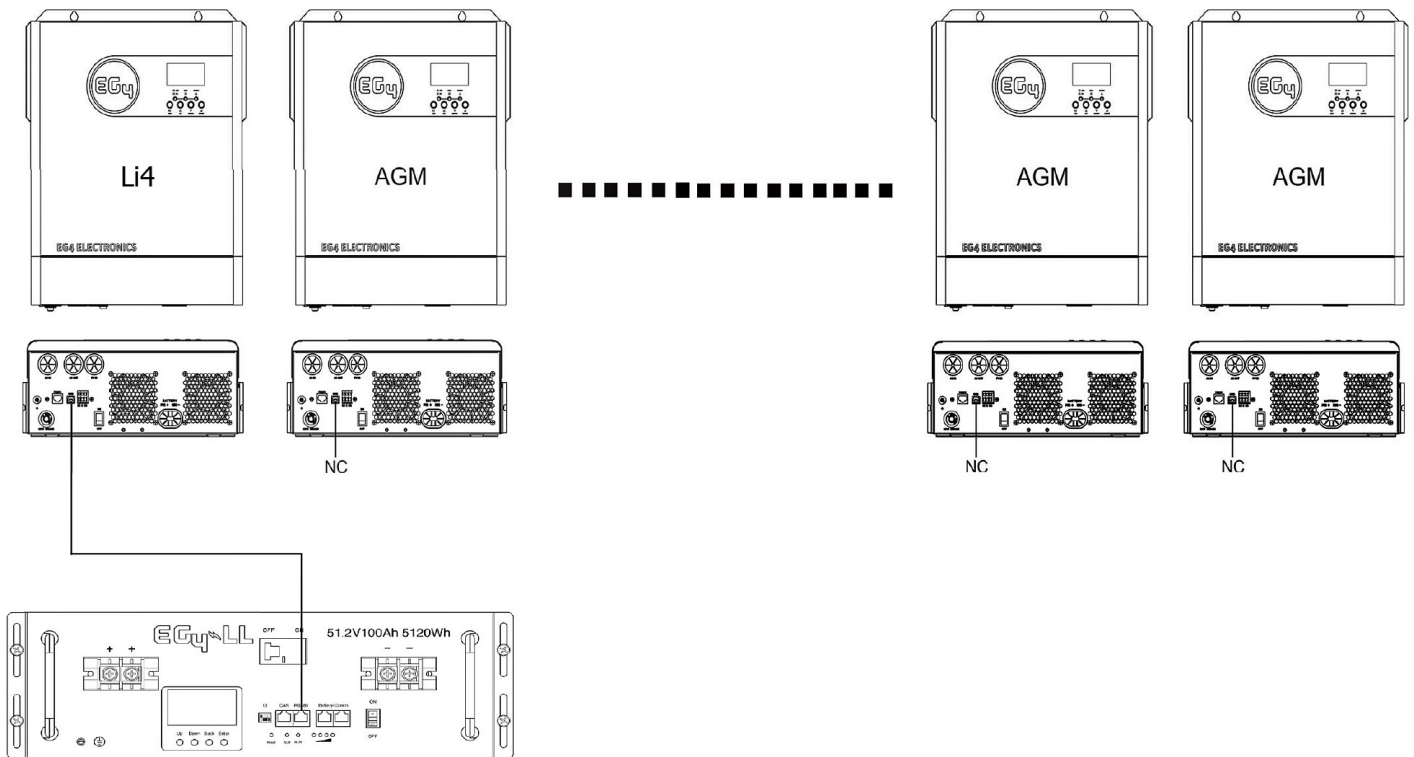

Parallel Operation in Single Phase (120V)

Program	Description	Selectable option	Comments
28	AC output mode	28 <u>PAL</u>	Parallel: This inverter is operated in a parallel system. Communication cables need to be connected as shown in the diagram below

## Power Connection

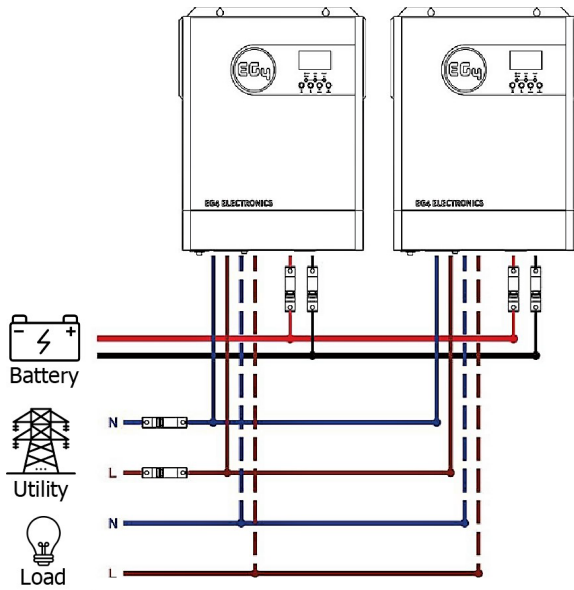

## Communication Connection



## 7.10 THREE INVERTERS IN SINGLE PHASE PARALLEL:

### Power Connection

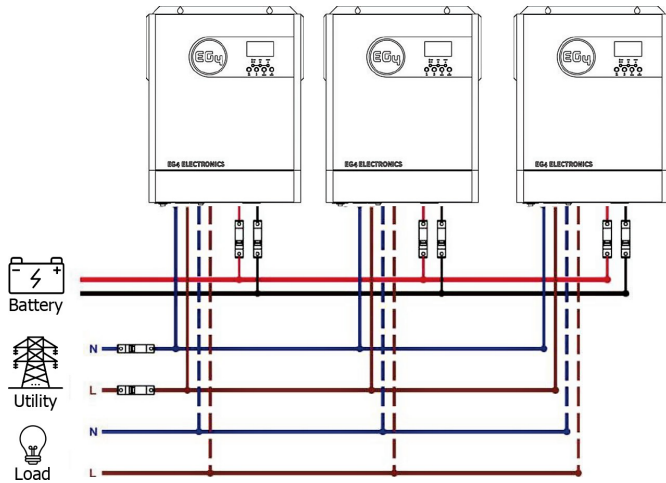

### Communication Connection

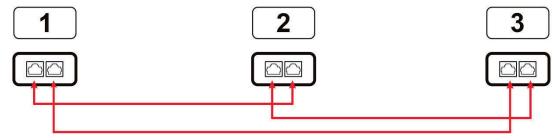

## 7.11 FOUR INVERTERS IN SINGLE PHASE PARALLEL

### Power Connection

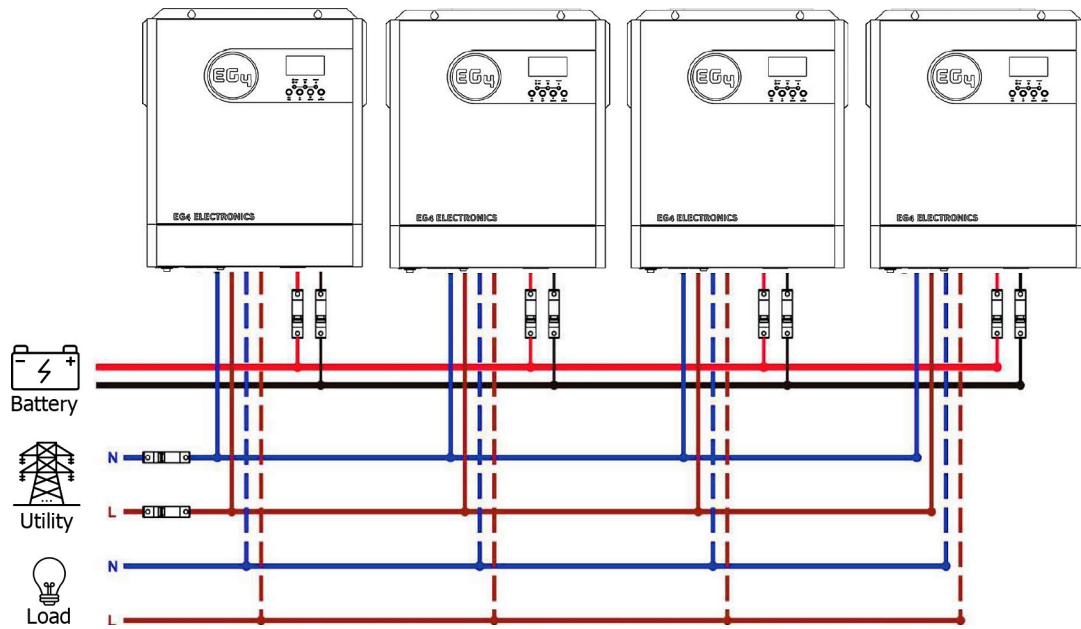

### Communication Connection



## 7.12 FIVE INVERTERS IN SINGLE PHASE PARALLEL

### Power Connection

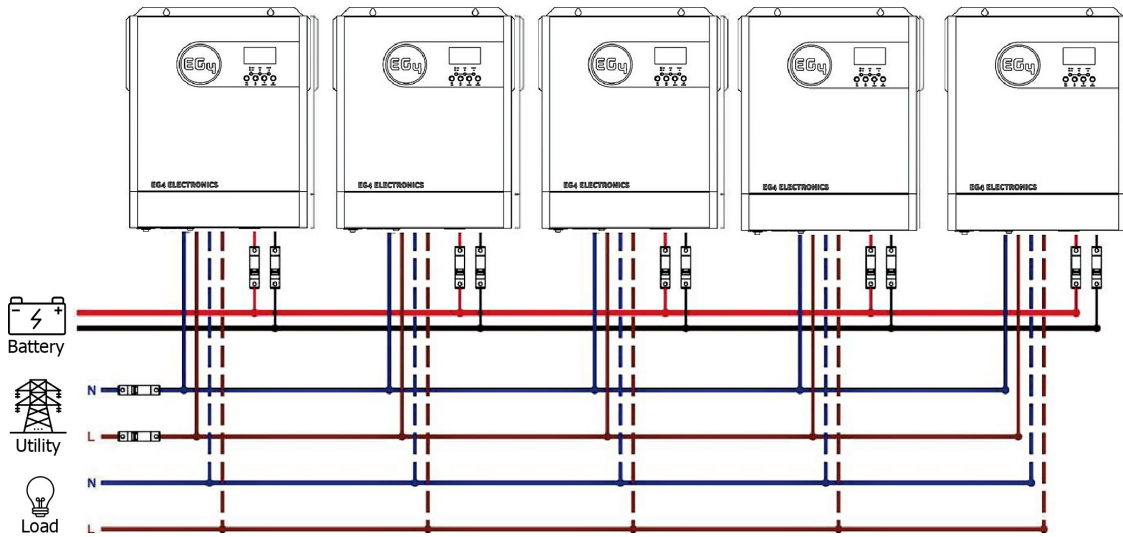

### Communication Connection

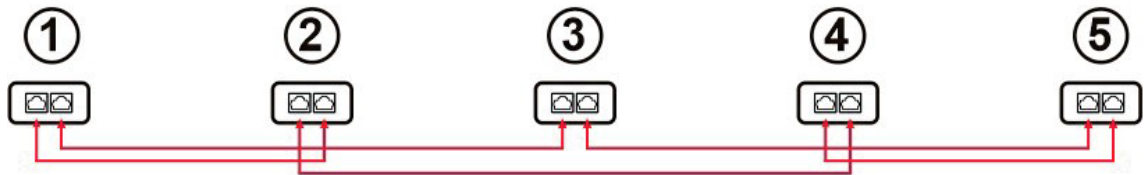

## 7.13 SIX INVERTERS IN SINGLE PHASE PARALLEL

### Power Connection

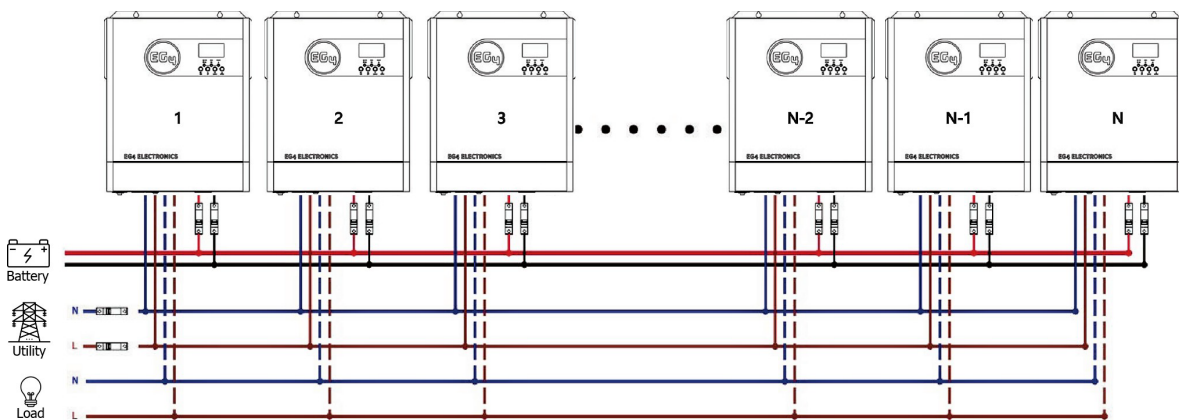



### Communication Connection



**Note:** Max of 12 units. The best practice is to minimize the number of jumps between inverters by alternating between 1 and 2 jumps on each inverter.

## 8. SUPPORT 3-PHASE EQUIPMENT

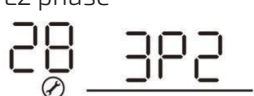
### 8.1 ONE INVERTER IN EACH PHASE

Program	Description	Selectable option
28	AC output mode	L1 phase  The inverter is operated in L1 phase in 3-phase application
		L2 phase  The inverter is operated in L2 phase in 3-phase application
		L3 phase  The inverter is operated in L3 phase in 3-phase application

**Power Connection: One inverter in each phase**

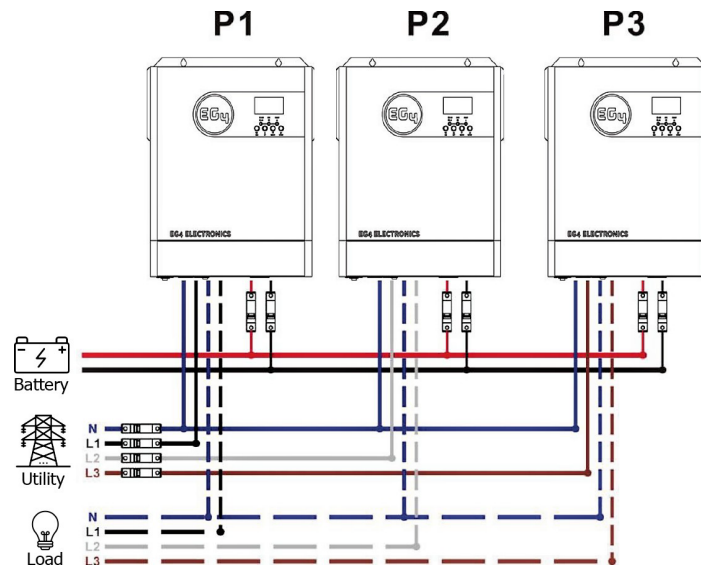

### 8.2 THREE INVERTERS IN EACH PHASE:

**Communication Connection**

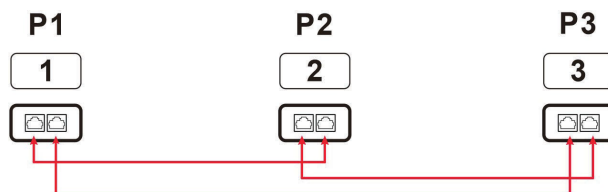

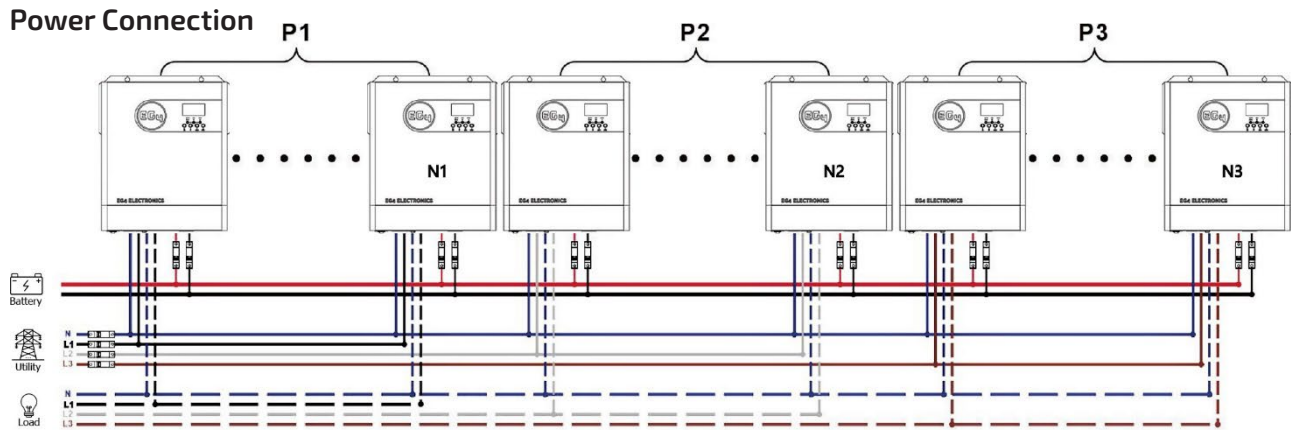

**Note:** Depending on load demand, there can be up to 10 inverters on any one phase.

P1: L1-phase, P2: L2-phase, P3: L3-phase.

$N = N1 + N2 + N3$ ,  $N_{max} = 12$  units

$N1_{max} = 10$  units are in one phase and one inverter for the other two phases ( $N2 = N3 = 1$ ):

**Power Connection**

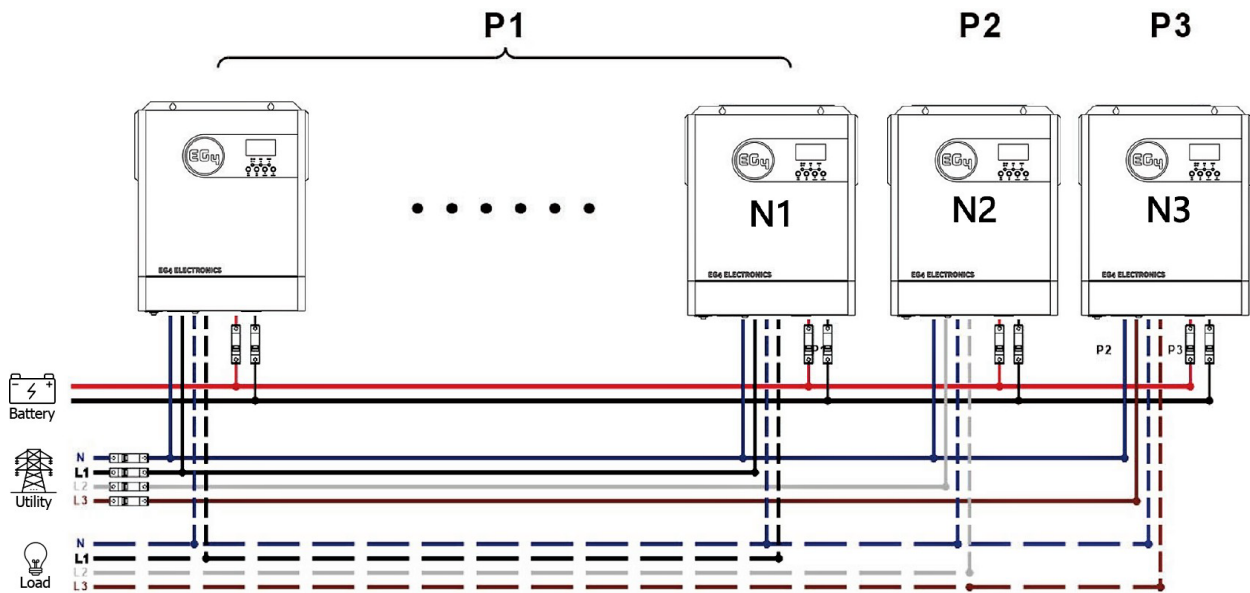

**Note:** Depending on load demand, there may be up to 10 inverters on any one phase.

P1: L1-phase, P2: L2-phase, P3: L3-phase.

$N = N1 + N2 + N3$ ,  $N_{max} = 12$  units

$N1_{max} = 5$  &  $N2_{max} = 6$  units are in two phases and one inverter for the other phase ( $N3 = 1$ ):

## Power Connection

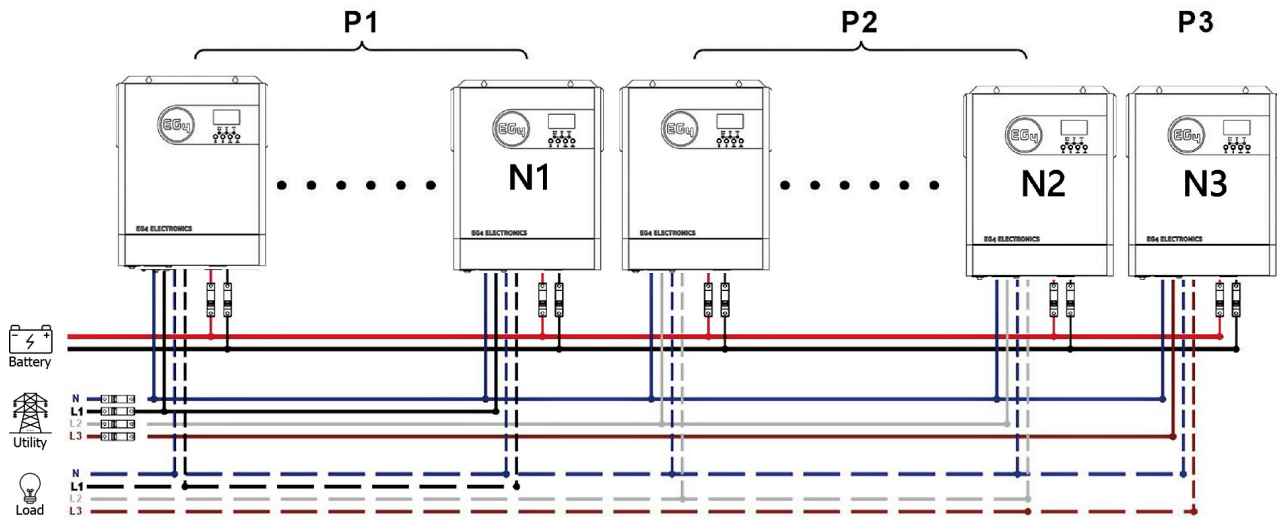

## Communication Connection



## 9. SUPPORT FOR PARALLEL SPLIT-PHASE (120V/240V)

### 9.1 TWO INVERTERS IN PARALLEL SPLIT-PHASE

Program	Description	Selectable option	
28	AC output mode	28 2P1	The inverter is operated in L1 phase in split application
		28 2P2	The inverter is operated in L2 phase in split application

#### Two inverters in parallel Split-Phase

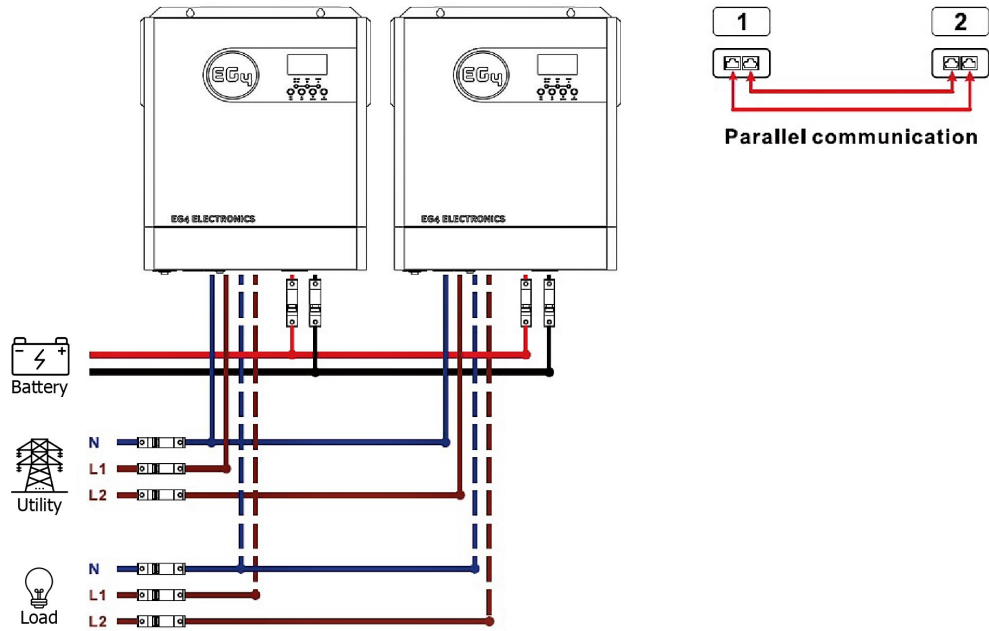

## 9.2 GREATER THAN TWO INVERTERS IN PARALLEL SPLIT-PHASE

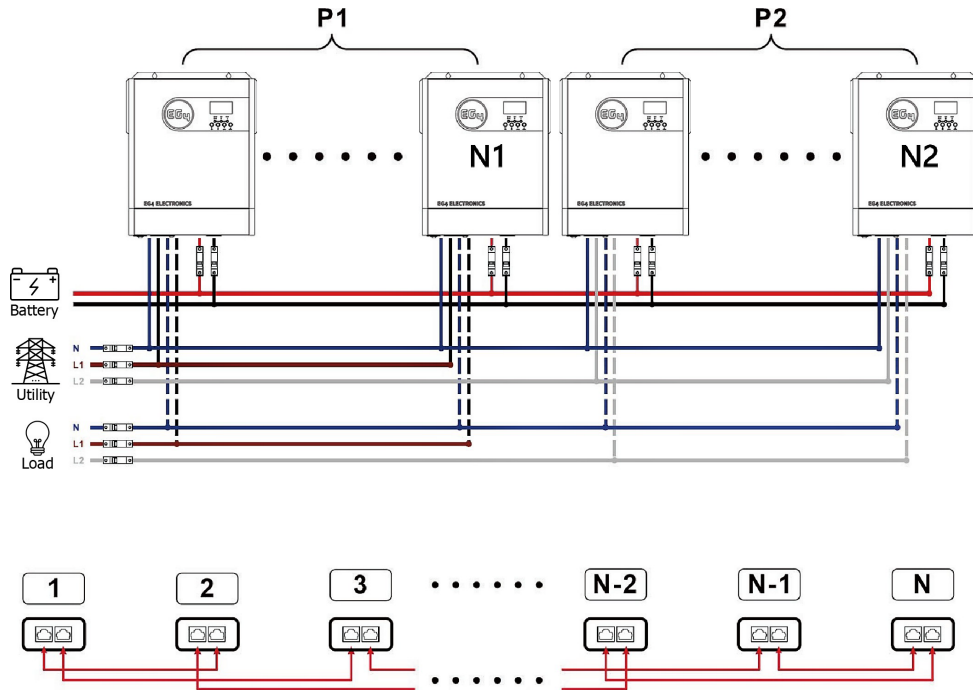

**Note:** Depending on load demand, there may be up to 6 inverters on any one phase.  
 2P1: L1-phase, 2P2: L2-phase;  $N=N1+N2$ ,  $N_{max}=12$ units





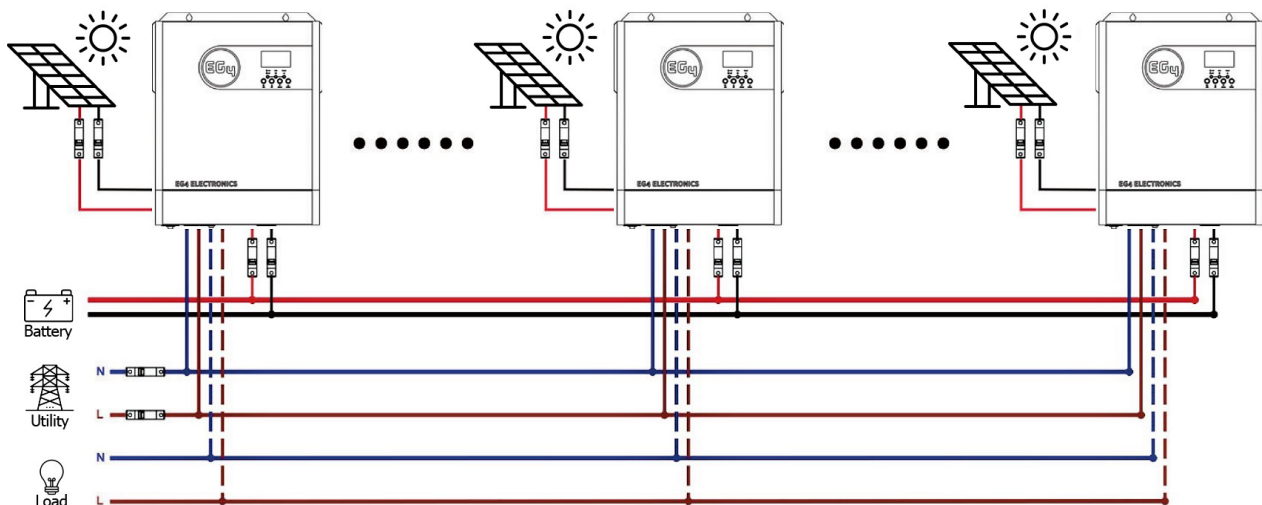

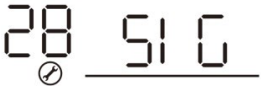

## 9.3 PV CONNECTION

**CAUTION:** Each inverter should connect to PV modules separately.





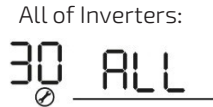

## 9.4 SPLIT-PHASE AND 3 PHASE LCD SETTING AND DISPLAY

### 9.4.1 SETTING PROGRAM:



Program	Description	Selectable option	Comments
28	AC output mode	Single: This inverter is used in single phase application. 	Parallel: This inverter is operated in parallel application. 
		L1 phase 	The inverter is operated in L1 phase in 3-phase application
		L2 phase 	The inverter is operated in L2 phase in 3-phase application
		L3 phase 	The inverter is operated in L3 phase in 3-phase application
			The inverter is operated in L1 phase in split-phase application
			The inverter is operated in L2 phase in split-phase application
30	PV Operation (Only applies for setting "Solar first" in program 1: Output source priority)	One Inverter (Default): 	When "ONE" is selected, as long as one of the inverters has been connected to PV modules and PV input is normal, parallel, or 3-phase system will continue working according to the rule of "solar first" setting.  For example, two units are connected in parallel and set to "SOL" in output source priority. If one of two units has connected to PV modules and PV input is normal, the parallel system will provide power to loads from solar or battery power. If both are not sufficient, the system will provide power to loads from utility.

		<p>All of Inverters:</p> 	<p>When “ALL” is selected, parallel or 3-phase system will continue working according to the rule of “solar first” setting only when all inverters are connected to PV modules.</p> <p>For example, two units are connected in parallel and set to “SOL” in output source priority. When selecting “ALL” in program 30, it is necessary to have all inverters connected to PV modules and the PV input normal to allow the system to provide power to loads from solar and battery power. Otherwise, the system will provide power to loads from utility.</p>
--	--	--	---

## 9.4.2 FAULT CODE DISPLAY:

Fault Code	Fault Event	Icon on
24	Host loss	
25	Synchronization loss	
26	Incompatible battery type	
27	Firmware version inconsistent	

## 9.4.3 WARNING CODE DISPLAY:

Warning Code	Warning Event	Icon on
16	CAN communication loss	
17	AC output mode setting is different	
18	Battery voltage detected different	

## 9.5 COMMISSIONING PARALLEL SYSTEMS

**Step 1:** Check the following requirements before commissioning:

- Ensure all wire connections are correct.
- Ensure the communications cable is connected.
- Ensure all AC In/Out breakers are open (off), and all neutral wires are connected.
- Ensure inverter DC breakers are closed (on) and turn on batteries.

**Step 2:** Turn on all inverters and wait for boot-up.

LCD display in Master unit	LCD display in Slave unit

**NOTE:** Master and slave units are randomly defined. If it is master, the **P** icon BLINKS. If it is the slave, the icon is 'on' steady.

**Step 3:** Put the unit's power switch into the OFF position to place the unit in Standby Mode.

**Step 4:** Configure LCD program 28 on each inverter, press enter to save.

- Parallel Single Phase - Each unit is PAL
- Parallel Split-Phase - L1 unit(s) set as 2P1 and L2 unit(s) set as 2P2 - 2P1+ 2P2 + N = split-phase 120V/240V
- Parallel 3 Phase - L1 unit(s) set as 3P1, L2 unit(s) set as 3P2, L3 unit(s) set as 3P3

LCD display in Master unit	LCD display in Slave unit

**Step 5:** Turn on all units sequentially starting with the Master.

**Step 6:** Switch on all AC Input breakers. If AC connection is detected and split-phases are matched with unit setting, they will work normally. Otherwise, the AC icon on the LCD screen will be flashing and will not work in Line Mode.

**Step 7:** If there is no fault alarm, the system is ready to support split-phase equipment and is correctly installed.

**Step 8:** Please switch on all load side breakers. The system will start to provide power to the loads.

**Note:** To avoid overload occurring, before turning on breakers on the load side, ensure all system components are operational.

## 9.6 PARALLEL TROUBLESHOOTING GUIDE

Below is a list of faults, warning codes, potential scenario issues, explanations of code meaning, as well as possible steps for correction.

In most cases a full system reboot will remedy any erroneous errors. The steps for a complete system reboot are (in this order) as follows:

1. Inverter – set to standby (move power switch to OFF position)
2. PV/AC – input breaker OFF
3. Batteries – breaker OFF

Once the system has fully shut down, toggle the power switch between the ON and OFF position for approximately 30 seconds to drain the capacitors. When that step is complete, ensure your inverter’s power switch is in the OFF position before restarting the system in the following order:

1. Batteries – breaker ON
2. PV/AC – input breaker ON
3. Inverter – breaker ON

**Fault Codes**

Code	Explanation	Troubleshooting Steps
Fault Code 24 – Host Data Loss	If running more than one inverter, the host has stopped communication or has gone offline.	<p>Do a complete system shutdown.</p> <p>Once the system has fully shut down, toggle the power switch between the ON and OFF position for approximately 30 seconds to drain the capacitors.</p> <p>When that is complete, ensure your inverter’s power switch is in the OFF position and then restart your system.</p> <p>If this effort is showing and a single inverter is being used, ensure that setting 28 is set to SIG.</p> <p><i>**If problem persists, contact your retailer.</i></p>

<p>Fault Code 25 – Synchronization Data Loss</p>	<p>One or more of the inverters in parallel has stopped communicating with the others.</p>	<p>Ensure that no communications cables have come unplugged or have been removed from the inverters.</p> <p>Do a complete system shutdown.</p> <p>Once the system has fully shut down, toggle the power switch between the ON and OFF position for approximately 30 seconds to drain the capacitors.</p> <p>When that is complete, ensure your inverter’s power switch is in the OFF position and then restart your system.</p> <p>Ensure that all inverters are in the same parallel mode/phase mode.</p> <p><i>**If problems persist, contact your retailer.</i></p>
<p>Fault Code 26 – Incompatible Battery Type</p>	<p>It is possible that the battery type in setting 5 is incorrectly configured.</p>	<p>Navigate to setting 5 and configure your system for the correct battery type.</p> <p>e.g.: LI = Lithium, FLA = Flooded Lead Acid, AGM =Absorbed Glass Mat.</p> <p>Ensure that all battery connections are tight.</p> <p><i>*With EG4 batteries we recommend the terminals be torqued to 6 ft.-lbs. or 8 Nm.</i></p> <p><i>**If problems persist, contact your retailer.</i></p>
<p>Fault Code 27 – Firmware Version Inconsistent</p>	<p>It is possible, if using multiple inverters, that the firmware versions do not match</p>	<p>Check the version of each inverter via the LCD display and ensure that all inverters have the same firmware version. If they are not all the same, contact your retailer and obtain an authorized version of the newest firmware – then update all inverters.</p>

<p>Warning Code 16 – CAN Communications Loss</p>	<p>The inverter has stopped communicating with the BMS of the battery connected to it.</p>	<p>Ensure that no communications cables have come unplugged or have been removed from the inverters.</p> <p>Do a complete system shutdown.</p> <p>Once the system has fully shut down, toggle the power switch between the ON and OFF position for approximately 30 seconds to drain the capacitors.</p> <p>When that is complete, ensure your inverter’s power switch is in the OFF position and then restart your system.</p> <p>Ensure that all inverters are in the same parallel mode/phase mode.</p> <p><i>**If problem persists, contact your retailer.</i></p>
<p>Warning Code 17 – AC Output Mode is Different</p>	<p>Could indicate that the output is not in the correct phase mode for the attempted application.</p>	<p>Switch the power switch on the inverter from the ON position to the OFF position (this will place the unit into ‘Standby Mode’.</p> <p>Once the inverter is in standby mode, check Setting 28</p> <ul style="list-style-type: none"> <li>• Single Unit = SIG</li> <li>• Parallel System = PAL</li> <li>• Split-Phase System = 2P1 for the first leg and 2P2 for the second leg</li> </ul> <p>When this is complete, do a full system shut down (as outlined above). Once the system has fully shut down, toggle the power switch between the ON and OFF position for approximately 30 seconds to drain the capacitors. When complete, ensure your inverter’s power switch is in the OFF position and then restart your system.</p> <p><i>**If problem persists, contact your retailer.</i></p>

<p>Warning Code 18 – Difference in Battery Voltage</p>	<p>Indicates the inverter is reading a difference in battery voltage within the same stack.</p>	<p>Remove all loads and disconnect AC input and PV input.</p> <p>Check the battery voltage of all inverters (test voltage at the lug on the inverter).</p> <p>If the values from all inverters are CLOSE, ensure that all battery cables are the same length, material type, and size (all battery cables MUST be the same length for voltages to be equal across all batteries).</p> <p>Ensure that all cables are the same gauge (we recommend that cables between the battery and inverter are 4AWG – 2AWG, depending on length).</p> <p>We recommend a 125A breaker between your batteries and inverter. If you have such a breaker installed, ensure that your breaker is not BAD. You can determine this by temporarily bypassing the breaker and wiring straight to the inverter. If the issue is solved when bypassing, replace the breaker and restart your system.</p> <p>Ensure that all your battery’s terminal connections are sufficiently tightened.</p> <p>*With EG4 batteries we recommend the terminals be torqued to 6 ft.-lbs. or 8Nm.  <i>**If problem persists, contact your retailer.</i></p>
--	---	--

## 10. LITHIUM BATTERY SETTINGS

If choosing a Lithium battery for the inverter, there are two modes supported.

1. Inverter to BMS communication with the battery via RS 485 Modbus
2. User defined settings using voltage levels (*Program Settings 26 and 27*)

### 10.1 LITHIUM BATTERY BMS CONNECTION

There are two connections on the Lithium battery, the RS485 port for BMS and the DC power cables. Please follow the steps below to implement Lithium battery connection:

1. Connect the battery terminal based on recommended battery cable and terminal size.
2. Connect one end of the RS485 cable to the RS485 port on the battery and the other end to the inverter RS485 port.

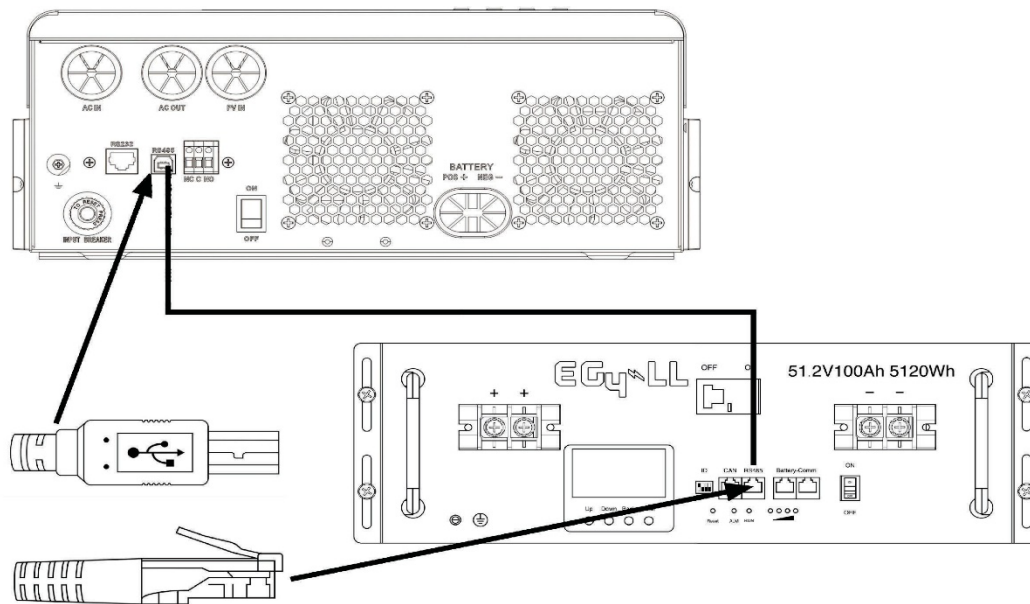

#### 10.1.1 LITHIUM BATTERY COMMUNICATION AND SETTINGS

The BMS communication cable (\*shown in the figure below) delivers information and signals between the Lithium battery and the inverter. Utilizing the BMS will allow the following actions:

- Setting the charging voltage, setting the charging current and battery discharge cut-off voltage according to the Lithium battery parameters.
- Setting the charging start and/or stop thresholds according to the status of Lithium battery.

Connect one end of the RS485 communications cable to the battery and the other end to the RS485 communication port of the inverter. Make sure the Lithium battery RS485 port connects to the inverter Pin-to-Pin using the port pin assignment shown below.

Pin Number	RS485 Port	Wire Color
Pin 1	RS485-B	Red
Pin 2	RS485-A	White
Pin 3	GND	Green
Pin 4	GND	Yellow
Pin 5	NC	NC

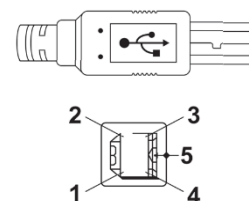

## 10.2 LCD SETTING

After connecting, finish and confirm the following settings:

Program	Description	Selectable option	
05	Battery type	05 AGM	AGM (default)
		05 FLd	Flooded
		05 USE	User-Defined
		05 LI 1	Standard communication Protocol form inverter supplier
		05 LI 2	Customized Protocol
		05 LI 3	Customized Protocol
		05 LI 4	EG4 Protocol
		05 LI 5	Customized Protocol
43	Setting SOC point back to utility source when selecting "SBU priority" or "Solar first" in program 01	43 BAT 050%	Default 50%, 20%~50% Settable
44	Setting SOC point back to battery mode when selecting "SBU priority" or "Solar first" in program 01	44 BAT 095%	Default 95%, 60%~100% Settable
45	Low DC cut-off SOC	45 BAT 020%	Default 20%, 5%~30% Settable

**Note: Program 43/44/45 are only available with successful communication, they will replace the Program 12/13/29 function at the same time program 12/13/29 becomes unavailable.**

## 10.2.1 LCD DISPLAY

If communication between the inverter and battery is successful, the following information will be shown on the LCD screen:

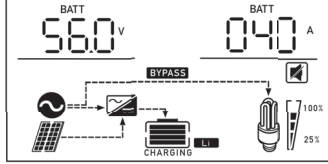
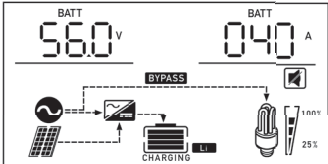
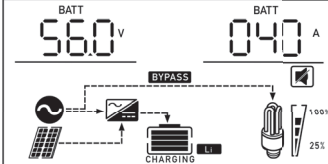
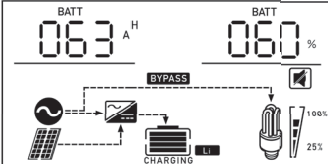
Item	Description	LCD display
1	Communication successful icon	
2	Lithium battery charging voltage	 <p>Max Lithium battery charging voltage is 56.0V.</p>
3	Lithium battery charging current	 <p>Max Lithium battery charging current is 40A.</p>
4	Lithium battery discharging is forbidden	<b>Li</b> will flash once every 1 second
5	Lithium battery charging is forbidden	<b>Li</b> will flash once every 2 second
6	Lithium battery capacity (AH)*Left Image	 <p>Lithium battery SOC is 63Ah and 60%</p>
7	Lithium battery state of charge (%)*Right Image	

## 10.3 SETTINGS FOR EG4 LITHIUM BATTERIES

### 1. EG4 Lithium battery settings:

Dip Switch: There are 4 Dip Switches which set different baud rates and battery group addresses. If switch position is turned to the “OFF” position, it means “0”. If switch position is turned to the “ON” position, it means “1”.

## EG4-LL Battery

- Dip 1, 2, and 3 are in the "ON" position  
\* "ON" = down
- Dip 4 is in the "OFF" position  
\* "OFF" = up
- The 1-3 "ON" & 4 "OFF" configuration is to indicate Master battery status and is reserved for communications with the inverter.
- A Max of 16 batteries can communicate in a single battery bank

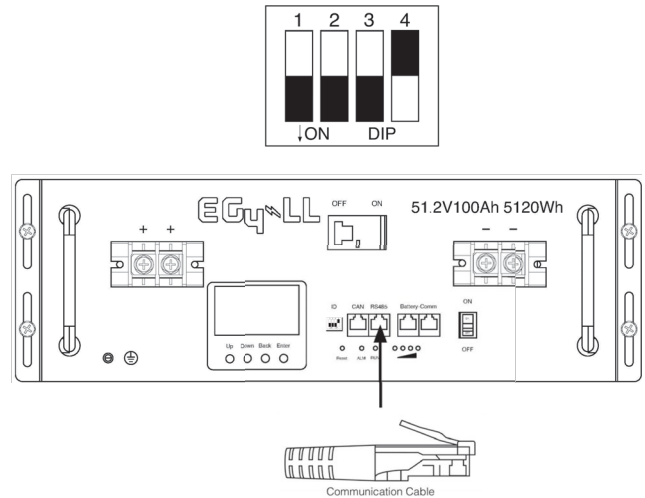

**NOTE: When using EG4-LLV2/LL-S batteries, the master address will be set to "1". Please see the image to the right.**



## EG4-LifePower4 Battery

- Dip 1, 2, 3, and 4 are in the "OFF" position  
"OFF" = down
- The ALL "OFF" position is to indicate the Master battery status and is reserved for communications with the inverter
- A Max of 16 batteries can communicate in a single battery bank.

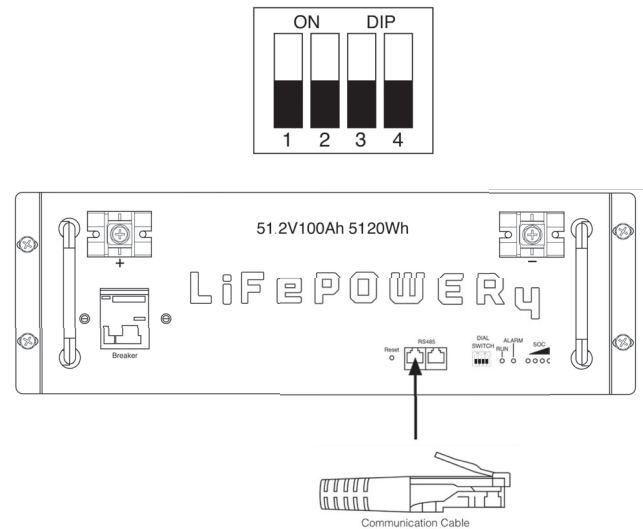

**Please Note: If you change the dipswitches, you must power cycle the batteries for the BMS to recognize the new dipswitch address.**

## 2. BMS Communication Guide

**Step 1:** Use the RS485 cable to connect inverter and EG4 battery.

**Step 2:** Turn on DC breaker between inverter and battery and switch on EG4 battery.

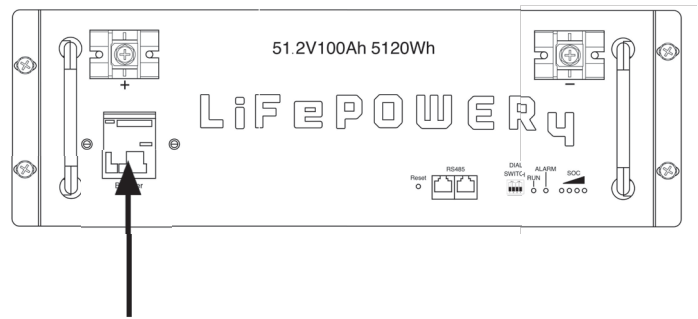
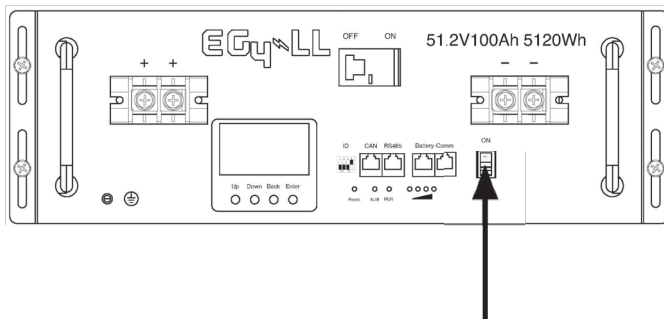

**Step 3:** Turn on the inverter.

**Step 4:** Be sure to select battery type as “Li4” in LCD program 5. All other inverters need to be set to “AGM”.

If communication between the inverter and battery is successful, the battery icon  on LCD display will light



## 10.4 SETTINGS FOR LITHIUM BATTERY WITHOUT COMMUNICATION

This example is used for Lithium battery applications without BMS communication. Please follow the steps below:

1. Before setting charging parameters, you must get the battery BMS specifications:

- A. Max charging voltage
- B. Max charging current
- C. Discharging protection voltage

2. Set battery type to “USE” (user-defined)

05	Battery Type	AGM (default) 	Flooded 
		User-Defined 	If “User-Defined” is selected, battery charge voltage and low DC cut-off voltage can be set in programs 26, 27 and 29.

3. Set Charging Voltage (CV) to Max charging voltage of BMS-0.5V.

26	Bulk Charging Voltage (CV Voltage)	Default setting: 56.4V 
		If self-defined is selected in program 5, this program can be set up. Setting range is from 24.0V to 31.0V for 24v model and 48.0V to 62.0V for 48v model. But the setting value must be more than or equal the value of program27. Increment of each click is 0.1V.





4. Set floating charging voltage as C.V voltage.

27	Floating charging voltage	default setting: 54.0V 
		If self-defined is selected in program 5, this program can be set up. Setting range is from 24.0V to the value of program 26 for 24v model and 48.0V to the value of program 26 for 48v model. Increment of each click is 0.1V.

5. Set Low DC cut-off voltage  $\geq$  discharging protection voltage of BMS+2V.

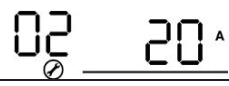
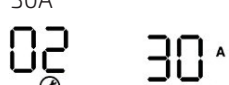
29	Low DC cut-off voltage		
		<p>If self-defined is selected in program 5, this program can be set up. Setting range is from 20.0V to 27.0V for 24v mode and 40.0V to 54.0V for 48v model. The setting value must be less than the value of program12. Increment of each click is 0.1V. Low DC cut-off voltage will be fixed to setting value no matter what percentage of load is connected.</p>	

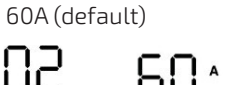
6. Set Max charging current, which must be less than the Max charging current of BMS.

02	Maximum charging current: To configure total charging current for solar and utility chargers. (Max. charging current = utility charging current + solar charging current)	10A 	20A 
		30A 	40A 
		50A 	60A (default) 
		70A 	80A 

7. Setting voltage point back to utility source when selecting “SBU priority” or “Solar first” in program 01. The setting value must be  $\geq$  Low DC cut-off voltage+1V or else the inverter will have a warning as battery voltage low.

12	Setting voltage point back to utility source when selecting “SBU priority” or “Solar first” in program 01. <b>Please Note: This is ONLY for AGM &amp; FLD battery types</b>	Available options in 48V models: 46V (default)
		

## 11. INVERTER MAINTENANCE

Electrical equipment must be properly maintained to increase longevity and consistency. Follow the steps below to help prevent component damage/deterioration:

1. Inspect the inverter every month to confirm nothing covers the inverter's vents. If it is covered, shut down the inverter and clear the vents to restore proper cooling.
2. Inspect the inverter every 3 months to verify the operating parameters are normal, and there is no abnormal heating or noise from any components in the system.
3. Inspect the inverter every 6 months to check for any damaged cables, accessories, or terminals.

If unable to identify the source of any abnormal operations, contact the distributor's technical support team for additional information.

## 12. TROUBLESHOOTING GUIDE

Below is a list of faults, warning codes, potential scenario issues, explanations of code meaning, as well as possible steps for correction.

In most cases a complete system reboot will remedy any erroneous errors. The steps for a complete system reboot are (in this order) as follows:

1. Inverter - set to standby (move power switch to OFF position)
2. PV/AC - input breaker OFF
3. Batteries - breaker OFF

Once the system has fully shut down, toggle the power switch between the **ON** and **OFF** position for approximately 30 seconds to drain the capacitors. When that step is complete, ensure your inverter's power switch is in the **OFF** position before restarting the system in the following order:

1. Batteries - breaker ON
2. PV/AC - input breaker ON
3. Inverter - switch ON

## 12.1 FAULTS

Problem	Indicator	Explanation/Cause	Possible Solution
Unit shuts down automatically during start up.	LED's will be off. Alarm will sound for 3 seconds.	Indicates your battery voltage is too low	<p>Verify battery voltage and SOC. If the battery has a low charge, charge the battery and then reattempt start up.</p> <p>Ensure battery is connected to the inverter with the correct polarity (RED to +) and (BLACK to -)</p> <p><i>**If problem persists, contact your retailer.</i></p>
No response after power switch is set to <b>ON</b>	NO LED's or alarms will sound.	<p>Could indicate that the battery voltage is too low to let the inverter boot up.</p> <p>Could also indicate that battery polarity is connected in reverse.</p>	<p>Ensure that the connections at both the battery and inverter are correct.</p> <p><i>*With EG4 batteries we recommend the terminals be torqued to 6ft lbs. or 8 Nm</i></p> <p>Ensure that the SOC of the batteries is sufficient (&gt;20%)</p> <p><i>**If problem persists, contact your retailer.</i></p>
Utility exists but inverter is in battery mode.	Input voltage is displayed as 0 on the LCD screen. Green LED is flashing.	Could indicate that the input breaker is tripped	<p>Ensure the AC input breaker is not tripped and that all AC input wires are installed correctly into the unit.</p> <p>Ensure the AC wires are an appropriate gauge (most use 10 AWG wire).</p> <p>Ensure that the AC lines are not too long. This could be causing a voltage drop off.</p>



























<p>Utility exists but the inverter is in battery mode.</p>	<p>Green LED is flashing.</p>	<p>Could indicate an insufficient quality of AC power - either Generator or AC utility Grid</p>	<p>If using a generator, ensure that it is running and verify the output voltage.</p> <p>Ensure that Setting 3 is set to APL and that the generator output voltage is within the range for that setting. (90-140VAC)</p> <p>Ensure Setting 1 is set to UTL.</p> <p><i>**If problem persists, contact your retailer.</i></p>
<p>When the inverter is powered on, internal relay is switching on and off repeatedly.</p>	<p>LCD and LEDs are flashing.</p>	<p>Could indicate that batteries are not connected.</p>	<p>Ensure that battery cables are installed correctly and are sufficiently tight.</p> <p><i>*With EG4 batteries we recommend the terminals be torqued to 6ft lbs. or 8 Nm</i></p> <p><i>**If problem persists, contact your retailer.</i></p>

## 12.2 FAULT CODES













Code	Explanation	Troubleshooting Steps
Fault Code 02 – Internal Temperature Alarm	Indicates that the internal temperature is over 212° Fahrenheit	<p>Ensure the inverter has sufficient airflow and the vents/fans are not clogged or blocked by debris.</p> <p>Ensure that the fans spin freely.</p> <p>Ensure the ambient temperature is lower than 212° Fahrenheit.</p> <p><i>**If problem persists, please contact distributor for additional steps</i></p>
Fault Code 03 – High Battery Voltage	Indicates the battery could be overcharged	<p>Refer to the battery manufacturer's specs to ensure the inverter is configured to the battery specifications.</p> <p>Ensure the correct voltage of batteries for the system are being used. E.g., a 48V inverter cannot support 24V batteries.</p> <p>Ensure the busbar is rated for the correct amperage being put on it. Over-amping a busbar could cause a high battery voltage warning.</p> <p><i>**If problem persists, please contact distributor for additional steps</i></p>
Fault Code 05 – Output Short Circuit	Indicates that either L1 on a single inverter system or L1 & L2 on a parallel inverter system are showing a short-circuit on the AC output	<p>Ensure all wiring is going to the correct breaker and phases have not been crossed. If running multiple inverters, test the continuity between the units using a multimeter.</p> <p>To run this test:</p> <ol style="list-style-type: none"> <li>1. Perform a complete system restart as instructed above.</li> <li>2. Set the multimeter to read Ohms.</li> <li>3. Take the Positive (+) (RED) lead and place it on L1 of the host inverter.</li> <li>4. Take the Negative (-) (BLACK) lead and place it on L1 of the slave inverter.</li> <li>5. The meter should read 0.</li> <li>6. If it reads OL, the lines are crossed or on the same bus causing the short.</li> </ol> <p>Ensure the appropriately sized wiring is being used per the inverter spec sheet.</p> <p><i>**If problem persists, please contact distributor for additional steps</i></p>

<p>Fault Codes 06 – Output Abnormal  <b>OR</b> Fault Code 22 – Output Voltage Too Low</p>	<p>Indicates the inverter output is &lt;190VAC or &gt;260VAC</p>	<p>Check loads to ensure that the inverter is not attempting to power a 240V load with only 120V output.</p> <p>If running multiple inverters, test continuity between the units using a multimeter.</p> <ol style="list-style-type: none"> <li>1. Do a complete system shutdown</li> <li>2. Once the system is off, turn on the breakers for AC output panel</li> <li>3. Set the multimeter to read Ohms</li> <li>4. Take the Positive (+) (RED) lead and place it on L1 of the host inverter.</li> <li>5. Take the Negative (-) (BLACK) lead and place it on L1 of the slave inverter.</li> <li>6. The meter should read 0.</li> <li>7. If it reads OL then the lines are crossed or on the same bus causing a short.</li> </ol> <p><i>**If problem persists, contact your distributor</i></p>
<p>Fault Code 07 – Overload Error</p>	<p>Indicates the inverter load has exceeded 110% of the output capacity</p>	<p>Perform a complete system restart. Once the system has restarted and is outputting, ensure the loads are kept &gt;110% of the operating capacity.</p>
<p>Fault Code 13 – Overcurrent or Surge</p>	<p>Indicates the inverter has detected an overcurrent event or a power surge.</p>	<p>Follow the directions above and restart the unit. Once the unit is restarted, if Fault 13 is still present, contact your distributor for additional steps.</p>
<p>Fault 14 – Bus Voltage Too Low</p>	<p>Indicates the voltage at the bus is insufficient to power loads.</p>	<p>Ensure that the inverter is not in Standby mode (power switch in the OFF position). Ensure the inverter is not attempting to power loads that call for a higher voltage than what is produced. Perform a full system restart per the guide above. If the fault persists after restarting, contact your distributor for additional steps.</p>
<p>Fault Code 16 – Output Voltage Imbalanced</p>	<p>Indicates there may be multiple loads on a single leg of output power.</p>	<p>Ensure that the loads are evenly balanced in the main load panel. Perform a full system restart per the guide above. If the fault persists after restarting, contact your distributor for additional steps.</p>

## 12.3 FAULT REFERENCE CODES

Fault Codes	Fault Event	Code Icon
01	Over temperature of inverter module	
02	Over temperature of DCDC module	
03	Battery voltage is too high	
04	Over temperature of PV module	
05	Output short circuited.	
06	Output voltage is too high.	
07	Overload time out	
08	Bus voltage is too high	
09	Bus soft start failed	
10	PV over current	
11	PV over voltage	
12	DCDC over current	
13	Over current or surge	
14	Bus voltage is too low	
15	Inverter failed (Self-checking)	
16	Over DC voltage in AC output	
18	Op current offset is too high	
19	Inverter current offset is too high	
20	DC/DC current offset is too high	
21	PV current offset is too high	
22	Output voltage is too low	
23	Inverter negative power	
24	Host loss	
25	Synchronization loss	
26	Incompatible battery type	
27	Firmware version inconsistent	

## 12.4 WARNING INDICATORS

Warning Code	Warning Event	Audible Alarm	Icon flashing
02	Temperature is too High	Beep three times every second	
04	Low battery	Beep once every second	
07	Overload	Beep once every 0.5 second	
10	Output power derating	Beep twice every 3 seconds	
15	PV energy is low	Beep twice every 3 seconds	
16	CAN communication loss	None	
17	AC output mode setting disparity	None	
18	Battery voltage disparity detected	None	
19	Lithium Battery communication failure	Beep once every 0.5 second	
20	Battery low and/or it is below the setting value of <i>Program 13</i>	Beep twice every 3 seconds	
E9	Battery equalization	None	
bP	Battery is not connected	None	

## 13. WI-FI COMMUNICATIONS DONGLE

The EG4-3000EHV inverter comes with a Wi-Fi communications dongle and interface cable. The dongle allows the user to remotely access the unit for monitoring and control purposes. The following instructions describe the installation and setup process.

### 13.1 INSTALLATION AND SETUP

#### 13.1.1 INSTALLATION

**STEP 1:** Screw the Wi-Fi antenna onto the Wi-Fi Module body as shown in the figure to the right.



**STEP 2:** Connect the communication cable to the Wi-Fi Module as shown below.

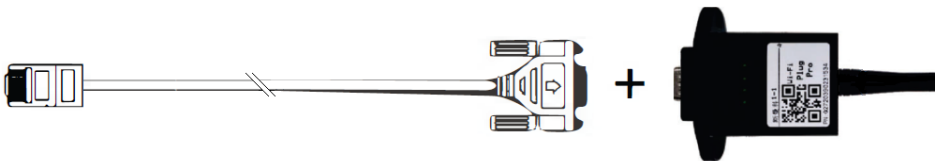

**STEP 3:** Plug the communication cable RJ45 plug into the 3000EHV RS232 port (RJ45 Jack) as shown below.

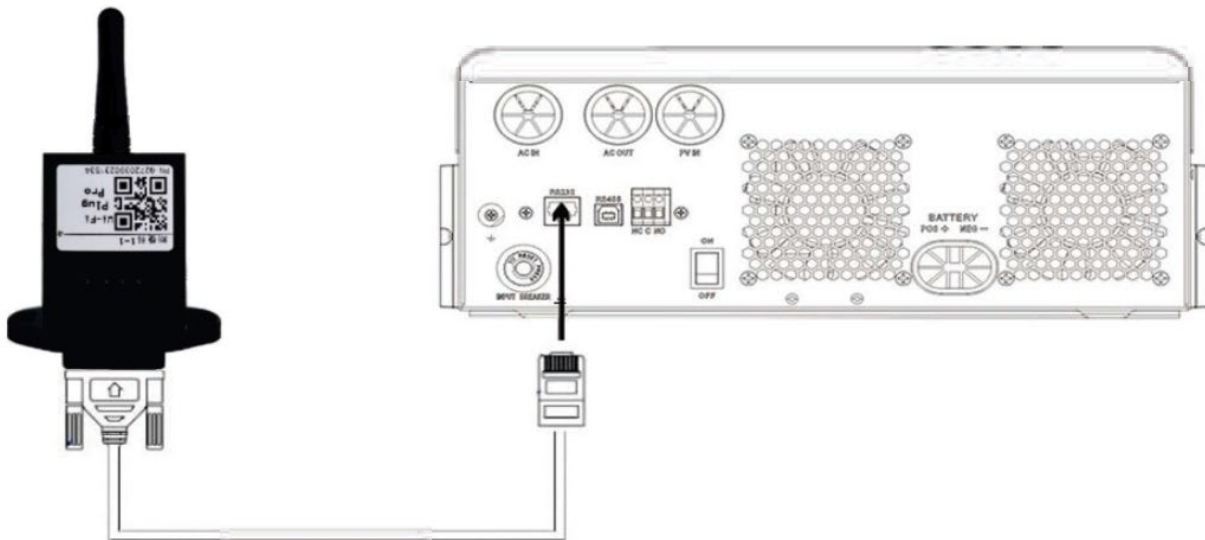

## 13.1.2 ACCOUNT CREATION

**STEP 1:** Download the SmartESS® Wi-Fi APP to your mobile device using the QR Code to the right or search “SmartESS” in your mobile device APP store.



**STEP 2:** Open the SmartESS® Wi-Fi App and press the “Sign up” button. Create an account by entering the requested information according to the prompts. In the example to the right, we have created an account with “UserName” as the Account Name and “Password” as the password. Press the “Sign in” button to access your account.

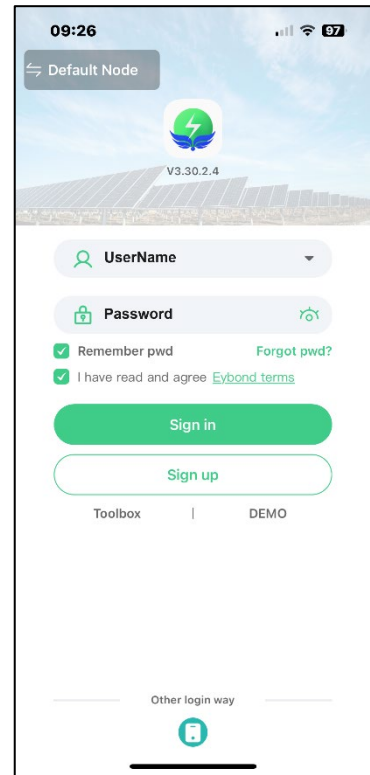

**STEP 3:** Sign in to the SmartESS® account created in Section 12.1.2. The SmartESS homepage will appear in the “Monitor” mode by default. This is evidenced by the “Monitor” icon in the lower left-hand corner being highlighted in green. Press the “+” button in the top right corner of the Monitor screen to add your Dongle (Datalogger).

**Note:** Datalogger and Dongle are used interchangeably in this document.

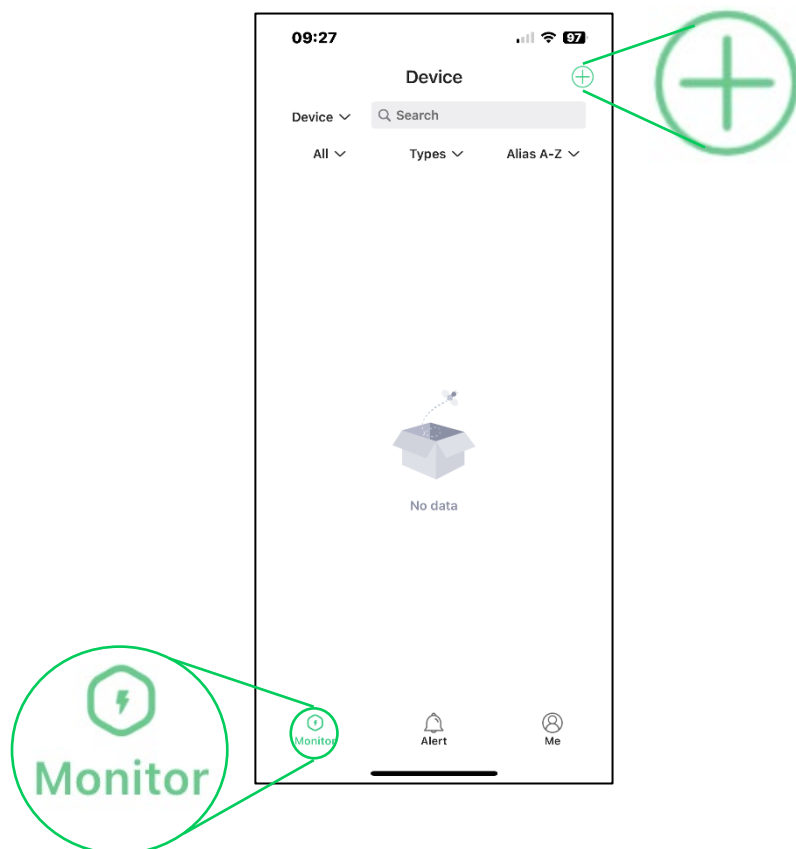

**STEP 4:** In the “Add a datalogger” screen, you will be asked for the Dongle Part Number (PN). You can enter this information in one of two ways:

- A. Enter the Wi-Fi Dongle Part Number (PN) manually. The dongle part number can be found on the side of the Dongle. In this example the PN is “QXXXX-YY”.



- B. Use the “SCAN” button to have your phone’s camera automatically scan the QR code on the Wi-Fi Dongle.

**STEP 5:** After the dongle PN is populated (manually or automatically), press the “Next step” button to advance to the next screen.

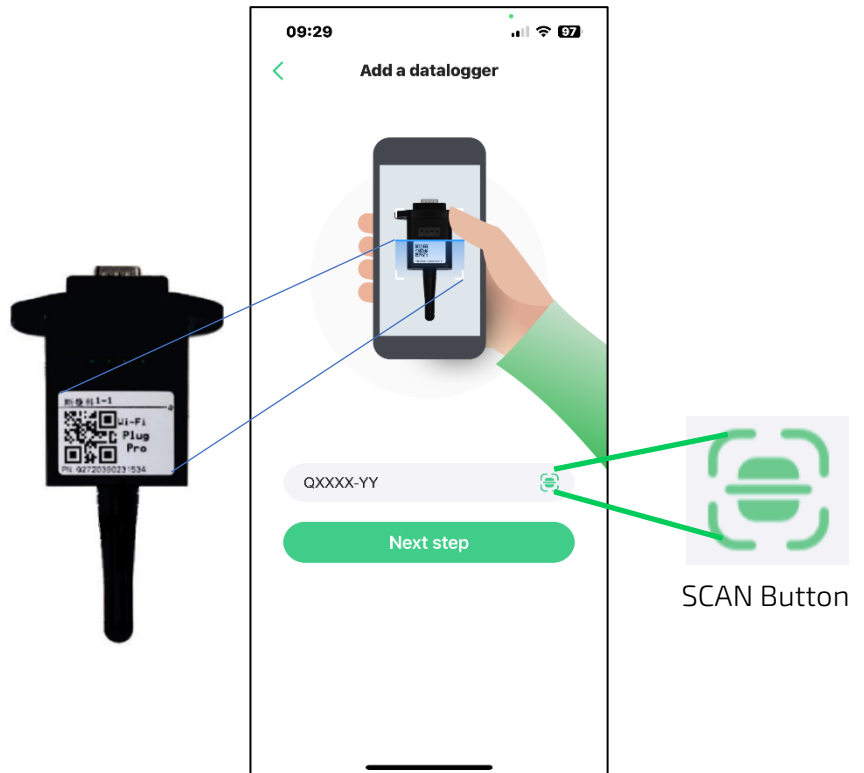

**STEP 6:** Enter the information requested as shown to the right in the red box. The “Design Power(kW)” is required. “Datalogger name” and “Installer” are optional. In this example, the inverter has a “3” kW capacity and we have named the Datalogger “Gen4”.

**STEP 7:** Press the “Done” button in the top-right corner of the screen when you are satisfied with your entries. A “Datalogger added successfully” message will appear momentarily and you will automatically be taken to the main SmartESS homepage as shown below.

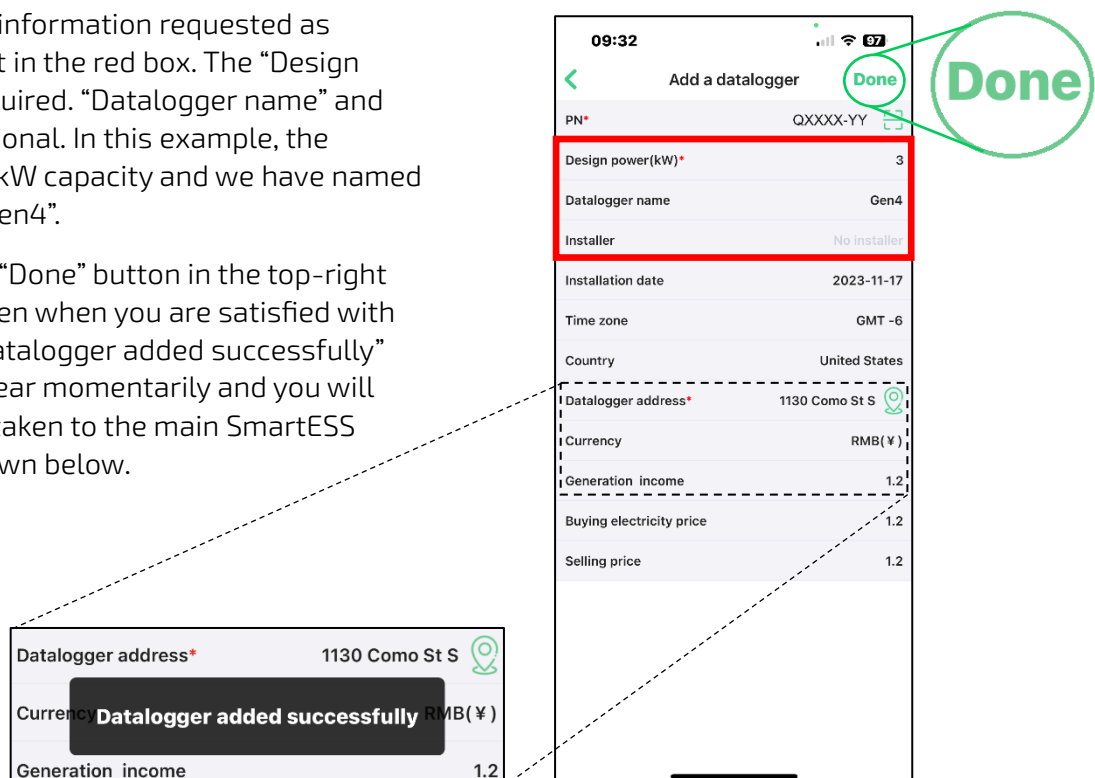

**STEP 8:** The SmartESS APP homepage appears in the “Monitor” mode.

**STEP 9:** Press the “Me” icon in the lower right-hand corner of the screen to enter the screen below.

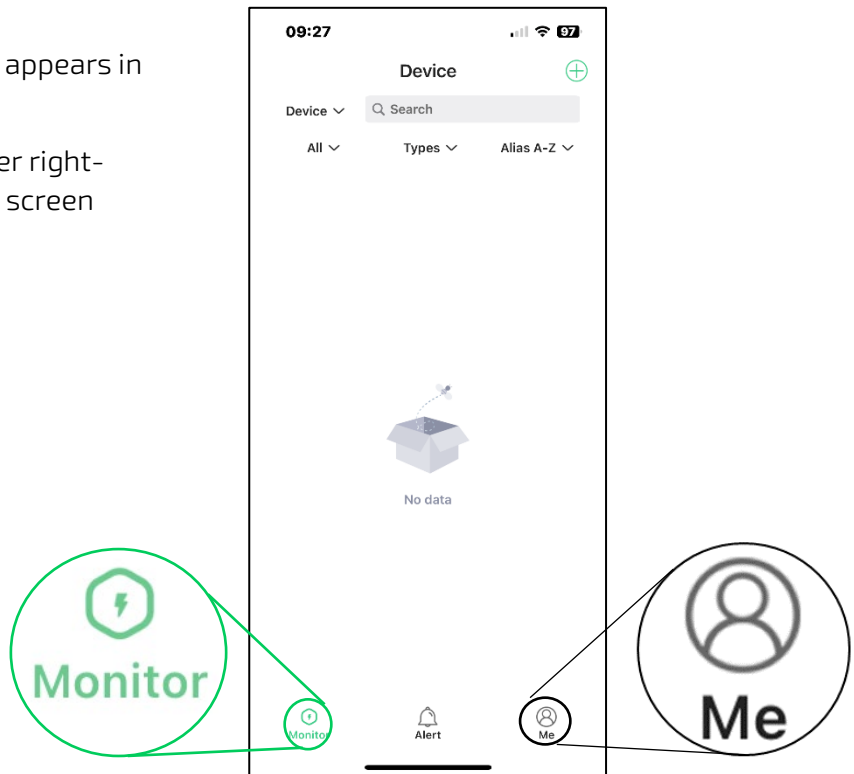

**STEP 10:** The “Me” icon in the bottom right corner will be highlighted in green. Press the “Network tools” icon to see the network tool options (see below). They are “BLE network” (not applicable to this unit) and “Wi-Fi Network”. Press the “Wi-Fi Network” button indicated below and you will be taken to the “Wi-Fi Pairing” screen.

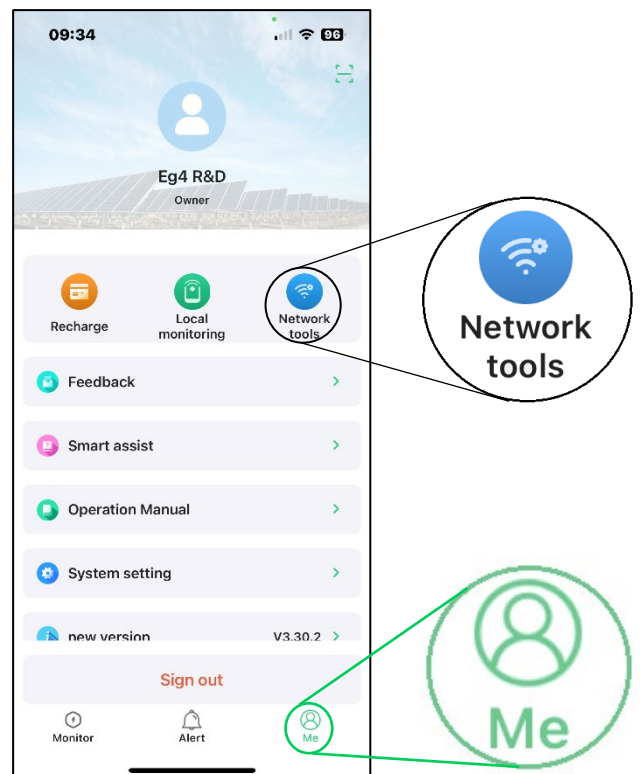
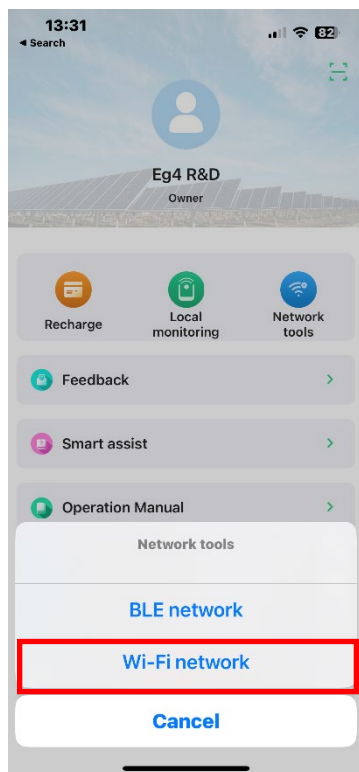

**STEP 11:** Once in the Wi-Fi Pairing screen, follow the three steps for Wi-Fi Pairing and press the “Next” button to complete the pairing process.

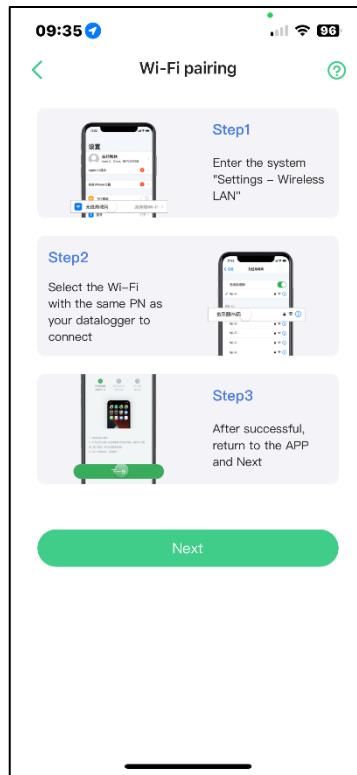

**STEP 12:** Go to the Wi-Fi Settings screen on your mobile device and select the Wi-Fi network that matches your dongle’s Part Number (see STEP 2 above). **The default Password is 12345678.** Enter this information and press “Next”. This will take you to the “Internet Settings” screen.

**STEP 13:** Enter the Router Name and Password for your home Wi-Fi Network. In the example to the right we have used “Lab Network” as the Router Name and “Enigma#1492” as the Password. Press “Confirm” to affirm your selections. While your internet settings are being configured, you will see the screen below. It may take 30 or more seconds to successfully configure your network. Please be patient.

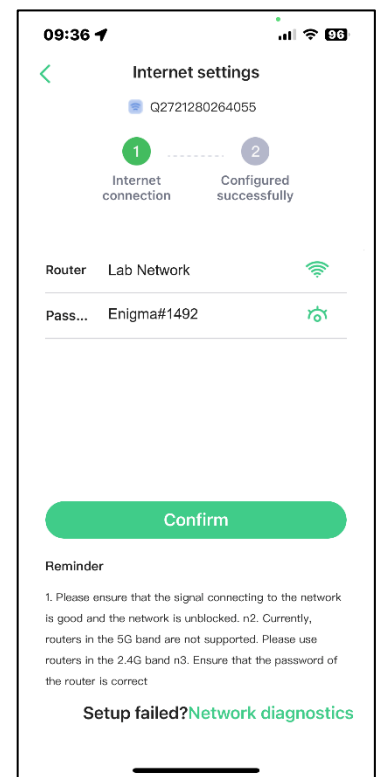

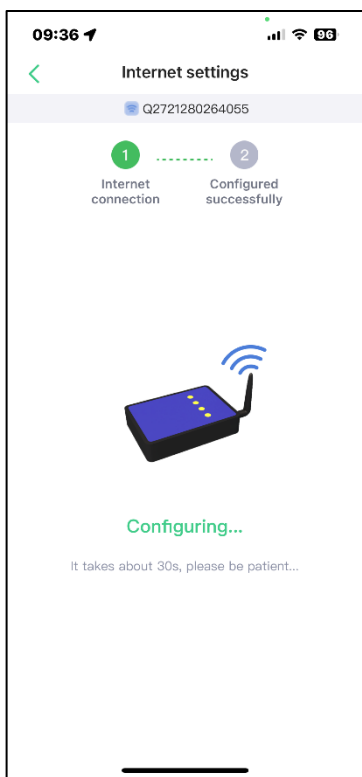

**STEP 14:** Once the internet is successfully configured, you will see the first screen to the right. Press the “Back to the homepage” button to return to the SmartESS homepage in the “Monitor mode” (second screen on the right). After a few moments, the inverter will begin reporting data.

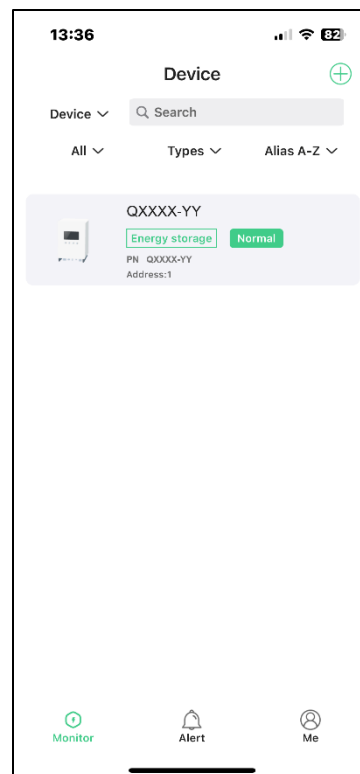
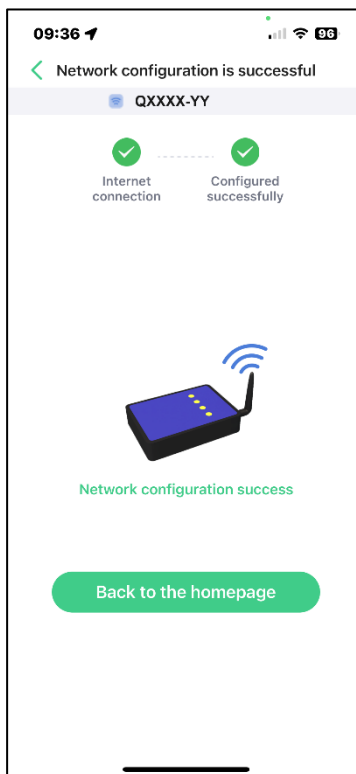





## CONTACT US

[support@eg4electronics.com](mailto:support@eg4electronics.com)

+1 (903) 609-1988

[www.eg4electronics.com](http://www.eg4electronics.com)