



samlexpower®

SAM Series Power Inverters

SAM-1000-12
SAM-1500-12
SAM-2000-12
SAM-3000-12

Owner's Manual

Please read this
manual **BEFORE**
installing your
inverter





MANUAL | Index

SECTION 1:

Important Safety Instructions 1

SECTION 2:

Description 3
Features 3
Principle of Operation 4

SECTION 3:

Product Layout 6

SECTION 4:

Installation 7

SECTION 5:

Operation 18

SECTION 6:

Protections, Monitoring & Trouble-shooting 20

SECTION 7

Specifications 24

SECTION 8

Warranty 26



SECTION 1 | Safety

IMPORTANT SAFETY INSTRUCTIONS

This manual contains important information regarding safety, operation, maintenance and storage of this product. Before use, read and understand all cautions, warnings, instructions and product labels, plus your vehicle's battery manufacturer's guidelines. Failure to do so could result in injury and / or property damage. The following safety symbols will be used in this manual to highlight safety and information:



Warning!

Indicates possibility of physical harm to the user in case of non-compliance.



Caution!

Indicates possibility of damage to the equipment in case of non-compliance



Info

Indicates useful supplemental information.



Warning!

To reduce the risk of fire, electric shock, explosion or injury

1. Do not connect in parallel with another AC source e.g. Utility AC Distribution Wiring / generator. This is NOT a Grid Tied Inverter!
2. Disconnect appliance plug from outlet strip or turn off the inverter before working on the appliance. Multiple Outlet Power Strips with switches and circuit breakers only interrupt power to the "Hot" receptacle terminals.
3. Precautions when working with batteries
 - Batteries contain very corrosive diluted Sulphuric Acid as electrolyte. Precautions should be taken to prevent contact with skin, eyes or clothing.
 - Batteries generate Hydrogen and Oxygen during charging resulting in evolution of explosive gas mixture. Care should be taken to ventilate the battery area and follow the battery manufacturer's recommendations.
 - Never smoke or allow a spark or flame near the batteries.
 - Use caution to reduce the risk of dropping a metal tool on the battery. It could spark or short circuit the battery or other electrical parts and could cause an explosion.
 - Remove metal items like rings, bracelets and watches when working with batteries and also use caution when working with metal tools. Batteries can produce a short circuit current high enough to melt / weld metals and thus, cause severe burn.
 - If you need to remove a battery, always remove the ground terminal from the battery first. Make sure that all the accessories are off so that you do not cause a spark.
4. Do not make any electrical connections or disconnections in areas designated as **IGNITION PROTECTED**. This includes 12VDC Power Plug (Cigarette Plug) connections and terminal connections.
5. This is not a toy - keep away from children.
6. Do NOT insert object into the air vents.



SECTION 1 | Safety



Caution!

1. The metal chassis of the inverter and the Grounding Terminal of the NEMA5-15R outlet(s) are internally bonded (connected) to the Negative DC Input Terminal on the inverter. In a vehicle / boat, the Negative Terminal of the battery is bonded to vehicle chassis / boat's hull. Hence, the metal chassis of the inverter and the AC loads will be automatically grounded (bonded to the vehicle chassis / boat's hull).
2. Please ensure that the Negative DC Input Terminal on the inverter or the Battery Negative Terminal on the battery itself is bonded to Earth Ground WHEN THE INVERTER IS USED ON LAND.
3. The Line and Neutral Terminals of the NEMA5-15R AC outlets are isolated from its Grounding Terminal. Thus, the metal chassis of the AC loads and the metal chassis of the inverter will also be isolated from the Line and Neutral. The Grounding Terminal of the AC outlet is connected to the input section of the Electronic Ground Fault Protection Circuit on the Power Circuit Board. Due to the above implementation, the voltage on the Neutral and Line Terminals of the AC outlet with respect to the chassis of the inverter / chassis of the AC loads will be pulsing DC voltage with average DC value of up to 50V (will read 75 VAC on AC scale of the Voltmeter because of pulsing nature of DC voltage). **DO NOT TOUCH THE NEUTRAL TERMINAL / NEUTRAL CONDUCTORS!**
4. Do not connect to AC distribution wiring where the Neutral is bonded to Ground. The inverter will see this as abnormal condition of Ground Fault and will shut down.
5. Do not use with Positive Grounded Electrical Systems (the majority of modern automobiles, RVs, trucks and boats use Negative Grounded Electrical Systems).
6. Observe correct polarity when connecting the DC input terminals of the inverter to the battery. Connect Positive of the battery to the Positive input connector of the inverter and the Negative of the battery to the Negative input terminal of the inverter. **Reverse polarity connection will result in a blown fuse and may cause permanent damage to the inverter. Damage due to reverse polarity is not covered under warranty.**
7. This inverter will not operate high wattage appliances that exceed the output power limit or the surge power limit.
8. Do not operate this inverter if it is wet.
9. Do not install in engine compartment – please install in a well-ventilated area.
10. This inverter is not tested for use with medical devices.





SECTION 2 | Description, Features & Principle of Operation



Info For additional technical and operational information on inverters, battery chargers and related topics, please refer to www.samlexamerica.com under "Support" and view "Application Notes" and/or "White Papers" section.

Description

The inverter converts 12 VDC voltage from battery or from other suitable 12 VDC source to 115V, 60 Hz AC voltage. The waveform of the of the AC output voltage is Modified Sine Wave.

Features

- High peak efficiency of 90%
- Very high power to weight ratio - compact and light weight
- Soft Start Technology for better surge performance
- Load controlled cooling fan for better efficiency
- Cool Surface Technology for cooler and safer touch temperature
- Universal Protection circuit for low / high DC input voltage, overload / short circuit, over temperature and Ground Fault
- Low Interference Technology for controlled RF noise

Soft Start Technology

This feature offers the following advantages:

- When the inverter is switched ON, the voltage ramps up to 115 VAC in around 2 sec. If the load was already ON at the time of switching ON of the inverter, starting surge current demanded by certain reactive devices like motors etc. will be reduced and there will be less likelihood of the inverter shutting down due to overload.
- If the inverter is switched ON first and then a load with higher starting / inrush current like SMPS / motor is switched ON, the voltage will dip momentarily and will ramp up and reduce inrush / starting surge current in the load as above
- Similar overload reduction will be initiated during any other momentary overload condition

Low Interference Technology

Innovative circuit design and noise filtration circuitry reduce RF interference in TV picture, audio and radio equipment

Cool Surface Technology

Normally, heat dissipating components are mounted directly on internal metal chassis surface of the inverter and hence, the chassis surface may rise to unsafe touch-temperature. In this inverter, heat-dissipating components are not mounted directly on the chassis of the unit but on PCB (Printed Circuit Board) mounted heat sink and, there is air gap between the heat sink and the chassis surface. The heat sink is cooled by load-controlled fan. As there is no direct contact between the heat sink and the chassis, the chassis surface remains much cooler and is safer to touch.





SECTION 2 | Description, Features & Principle of Operation

Load Controlled Cooling Fan

Cooling is carried out by convection and by forced air circulation by load-controlled fan. The fan will normally be OFF and will be switched ON automatically at the following loads:

SAM-1000-12	28 to 32 Watts
SAM-1500-12, SAM-2000-12 & SAM-3000-12	90 to 110 Watts

This will reduce energy consumption by the fan and will increase overall efficiency

Principle of Operation

Conversion of 12 VDC from the battery / other DC source to 115 VAC takes place in 2 stages. In the first stage, the 12 VDC is converted to high voltage DC (around 160 VDC) using high frequency switching and Pulse Width Modulation (PWM) technique. In the 2nd stage, the 160V high voltage DC is converted to 115V, 60 Hz Modified Sine Wave AC. (Note: 115 V is the RMS value of the Modified Sine Wave AC voltage. The peak value of the Modified Sine Wave AC voltage will be equal to the value of the above high voltage of around 160V. See the Fig 2.1 below)

Modified Sine Waveform - Characteristics & Comparison with Pure Sine Waveform

Please refer to Fig 2.1 below which shows one cycle of Modified Sine Wave and Pure Sine Wave for comparison.

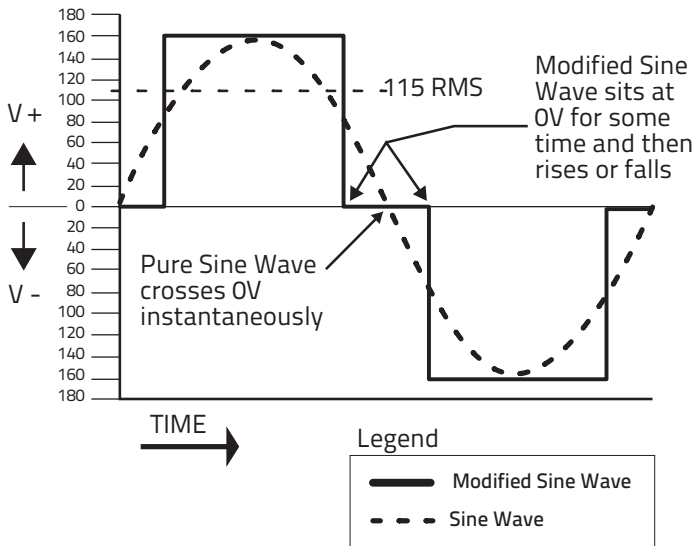

Fig 2.1 Modified Sine Wave and Pure Sine Wave - Comparison





SECTION 2 | Description, Features & Principle of Operation

The output waveform of the inverter is a Modified Sine Wave. In a Modified Sine Wave, the voltage waveform consists of rectangular pulses that approximate sine wave pulses of a Pure Sine Wave. The voltage rises and falls abruptly at a particular phase angle and sits at 0 Volts for some time before changing its polarity. In a Pure Sine Wave, the voltage rises and falls smoothly with respect to phase angle and the voltage changes its polarity instantly when it crosses 0 Volts.



Caution!

Certain devices (few examples given below) may malfunction when powered from Modified Sine Wave. Check with the manufacturer of the device for suitability of powering with Modified Sine Wave:

- Devices utilizing zero voltage crossing for timing control: Some clocks used in consumer electronic items (will not keep accurate time)
- Devices using modulation of RF signals on AC lines during zero crossing e.g. X-10 System for Home Automation
- Devices utilizing Triac based phase control for transformer less voltage step down e.g.:
 - Small battery chargers for hand tools, flashlights, night-lights, shavers etc.
 - Variable motor speed control in hand tools
 - Light dimmers
 - Temperature controllers e.g. Temperature Controlled Electric Blankets
- Devices using high capacitance based voltage multipliers for generating high voltage (will create very high surge currents) e.g.:
 - Photographic Strobe Lights
 - Laser Printers

Measuring Modified Sine-Wave Voltage with a “True Rms” Voltmeter

As mentioned above, Modified Sine Wave voltage is a type of square wave that has an RMS (Root Mean Square) value of 115 VAC in this inverter. A general-purpose AC voltmeter is calibrated to accurately measure the RMS value of a Pure Sine Wave and NOT of a Modified Sine Wave. If this general-purpose voltmeter is used to measure Modified Sine Wave voltage, it will indicate a lower value (96 VAC to 104 VAC). For accurately measuring the voltage of a Modified Sine Wave, use a voltmeter which is designed to measure “True RMS Values” like Fluke 87, Fluke 8060A, Fluke 77 / 99, Beckman 4410 etc.





SECTION 3 | Layout

Fig. 3.1 – SAM-1000-12

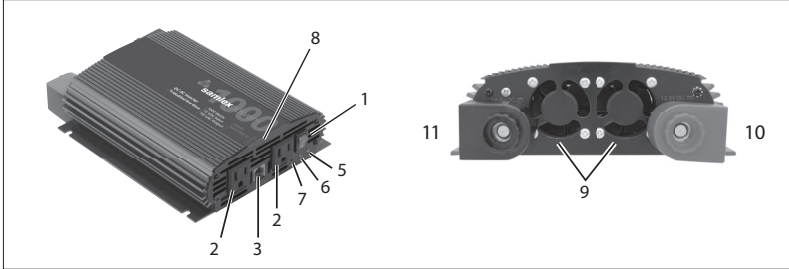

Fig. 3.2 – SAM-1500-12

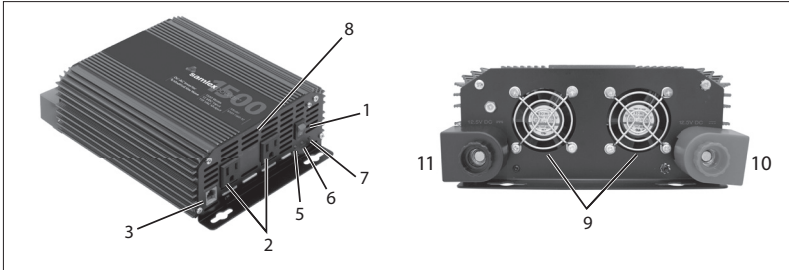
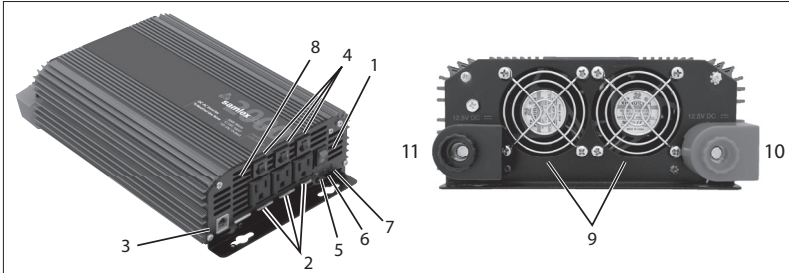

Fig 3.3 – SAM-2000-12, SAM-3000-12



LEGEND

- | | |
|--|--|
| 1. ON/OFF Switch | 7. RED LED - "Fault" |
| 2. NEMA5-15R AC Outlet | 8. Cooling Air Intake Slots |
| 3. Modular Jack for Remote Control SAM-RC (Optional) | 9. Opening for Fan Air Discharge |
| 4. 15A Circuit Breaker | 10. Positive Battery Input Terminal (with cover) |
| 5. YELLOW LED - "Input Fault" | 11. Negative Battery Input Terminal (with cover) |
| 6. GREEN LED - "Power" | |





SECTION 4 | Installation

Typical Installation Diagram

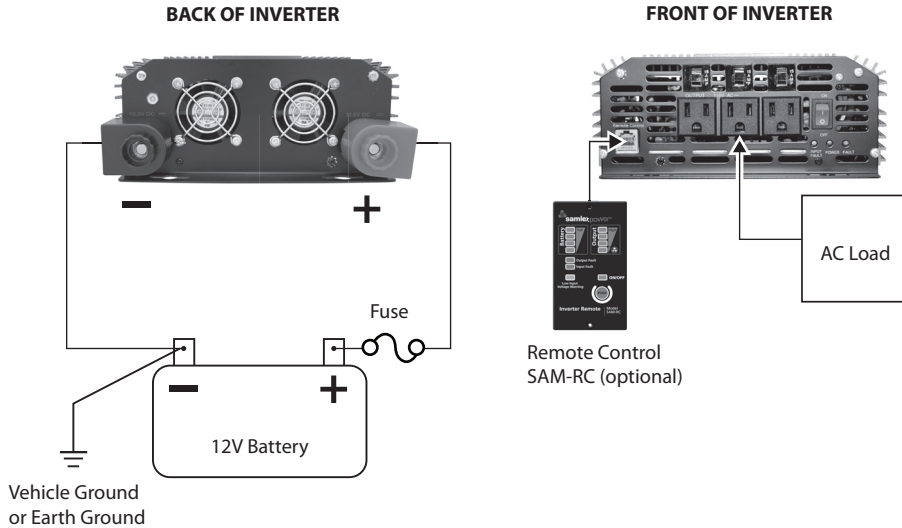

Fig 4.0. Typical Installation Diagram (front & back)

Safety of Installation

Please read safety instructions on pages 1-2 before commencing installation.

Installation Environment

For best operating results, the inverter should be placed on flat surface, such as the ground, car floor, or other solid surface. The power cord allows easy positioning of the inverter. The inverter should only be used in locations that meet the following criteria:

Dry- Do not allow water and/or other liquids to come into contact with the power inverter. In all marine applications, do not install the inverter below or near the waterline and keep the inverter away from moisture or water.

If Flooded / Wet Cell Type of battery is being used, ensure that it is not installed very close to the battery to avoid contact with acid / acid vapors

Cool - Ambient air temperature should be between 0°C (32°F) to 25°C (77°F) for full rated power. At higher temperature of 26°C (79°F) to 35°C (95°F), the output power should be de-rated to 80%. Do not place the inverter on or near a heating vent or any piece of equipment, which is generating heat above room temperature. Keep the inverter away from direct sunlight.

Ventilated - The unit is cooled by load-controlled fan. The fan will be off up to certain threshold of power and automatically switch on thereafter. The fan sucks cool air in from the ventilation slots on the AC outlet side and discharges hot air out of the fan opening (9) on the DC





SECTION 4 | Installation

Input Terminal side. Keep the areas surrounding the inverter clear by at least 10 cm to ensure free air circulation around the unit. Ensure that the ventilation slots and fan opening on the sides are not blocked. Do not place items on or over the inverter during operation.

Mounting Orientation

Two (2) flanges on the bottom with 2 mounting slots each are provided for mounting.

If the inverter is required to be mounted on a vertical surface like a wall, please ensure that the fan axis is horizontal as shown in Fig 4.1(a).

The DC input side has larger ventilation openings (9) for fan airflow. Mounting with the fan side facing up or down as shown in Figs 4.1(b) or 4.1(c) is NOT permitted due to safety considerations. If mounted as in Fig 4.1(b), metallic or other conductive object(s) may accidentally fall inside the unit through the fan ventilation openings, and create hazardous condition resulting from short circuit of internal high voltage section(s). If mounted as in Fig 4.1(c), hot / molten material from damaged internal portion of the unit due to malfunction may fall on combustible material on the floor and may create fire hazard.

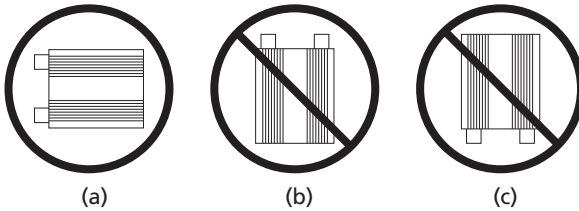

Fig 4.1
Mounting Orientation
on Wall

Remote Control Model SAM-RC (optional)

An optional wired Remote Control Model SAM-RC is available. It comes with 3M, RJ-45 cable. It can be used to Switch ON and switch OFF the inverter and also displays the operational status of the inverter using colored LEDs. Plug the Remote Control Modular Plug into the Modular Jack (3 - Fig 3.1, 3.2, 3.3). See typical installation diagram at Fig 4.0, page 7. Refer to separate Owner's Manual provided with the Remote for further details of the remote's operation.

DC Side Connections

See typical installation diagram at Fig 4.0, page 7.

General Information

1. The metal chassis of the inverter and the Grounding Terminal of the NEMA5-15R outlet(s) are internally bonded (connected) to the Negative DC Input Terminal on the inverter. In a vehicle / boat, the Negative Terminal of the battery is bonded to vehicle chassis / boat's hull. Hence, the metal chassis of the inverter and the AC loads will be automatically grounded (bonded to the vehicle chassis / boat's hull).
2. Please ensure that the Negative DC Input Terminal on the inverter or the Battery Negative Terminal on the battery itself is bonded to Earth Ground WHEN THE INVERTER IS USED ON LAND.





SECTION 4 | Installation

- 3. Do not use with Positive Grounded Electrical Systems (the majority of modern automobiles, RVs, trucks and boats use Negative Grounded Electrical Systems).
- 4. Observe correct polarity when connecting the DC input terminals of the inverter to the battery. Connect Positive of the battery to the Positive input connector of the inverter and the Negative of the battery to the Negative input terminal of the inverter. Reverse polarity connection will result in a blown fuse and may cause permanent damage to the inverter.
Damage due to reverse polarity is not covered under warranty.

Requirements of DC Input Power Source

Approx. DC Input Current required by Inverter = Power consumed by the AC Load in Watts ÷ 10.

DC input currents at Continuous Rated Power Output are shown (Table 4.1 below):

Table 4.1 DC Input Current

Model	Rated Input Current
SAM-1000-12	100A
SAM-1500-12	150A
SAM-2000-12	200A
SAM-3000-12	300A

12VDC input to the inverter should be fed from a 12V Battery System or from a 12.5VDC to 15VDC Regulated DC Power Supply. If a DC Power Supply is used, its output current capacity should be more than 2 times the maximum DC input current drawn by the inverter. **Further explanation of operation is based on DC input power from a 12V battery.** It is recommended that Deep Cycle Type Batteries are used. For detailed technical information on types, construction, specifications, sizing, connections and charging / discharging of Lead Acid Batteries, **please read online White Paper titled "Batteries, Chargers and Alternators"** at www.samlexamerica.com under Support/White Papers.

Connecting Batteries

Series Connection

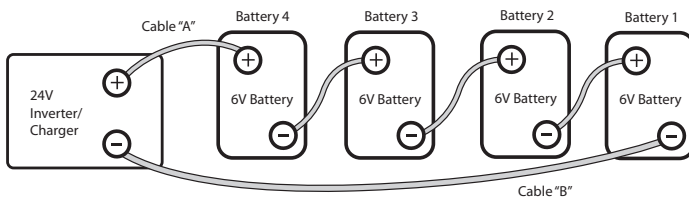

Fig. 4.2 Series Connection





SECTION 4 | Installation

When two or more batteries are connected in series, their voltages add up but their Ah capacity remains the same. Fig. 4.2 above shows 4 pieces of 6V, 200 Ah batteries connect- ed in series to form a battery bank of 24V with a capacity of 200 Ah. The Positive terminal of Battery 4 becomes the Positive terminal of the 24V bank. The Negative terminal of Battery 4 is connected to the Positive terminal of Battery 3. The Negative terminal of Battery 3 is connected to the Positive terminal of Battery 2. The Negative terminal of Battery 2 is connected to the Positive terminal of Battery 1. The Negative terminal of Battery 1 becomes the Negative terminal of the 24V battery bank.

Parallel Connection

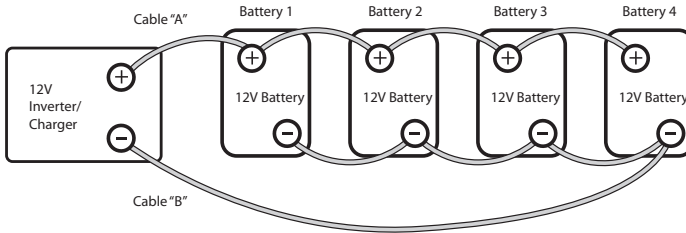

Fig. 4.3 Parallel Connection

When two or more batteries are connected in parallel, their voltage remains the same but their Ah capacities add up. Fig. 4.3 above shows 4 pieces of 12V, 100 AH batteries con- nected in parallel to form a battery bank of 12V with a capacity of 400 Ah.

The four Positive terminals of Batteries 1 to 4 are paralleled (connected together) and this common Positive connection becomes the Positive terminal of the 12V bank. Similarly, the four Negative terminals of Batteries 1 to 4 are paralleled (connected together) and this common Negative connection becomes the Negative terminal of the 12V battery bank.

Series – Parallel Connection

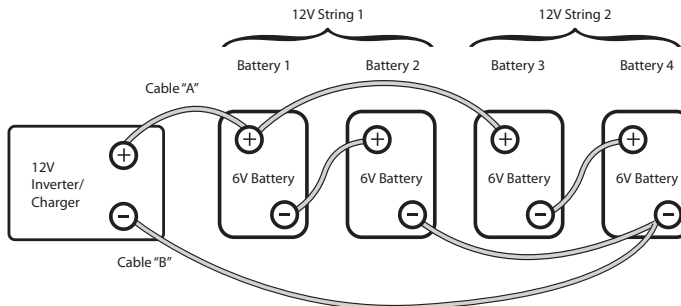

Fig. 4.4 Series-Parallel Connection





SECTION 4 | Installation

Figure 4.4 above shows a series – parallel connection consisting of four 6V, 200 Ah batteries to form a 12V, 400 Ah battery bank. Two 6V, 200 Ah batteries, Batteries 1 and 2 are connected in series to form a 12V, 200 Ah battery (String 1). Similarly, two 6V, 200 Ah batteries, Batteries 3 and 4 are connected in series to form a 12V, 200 Ah battery (String 2). These two 12V, 200 Ah Strings 1 and 2 are connected in parallel to form a 12V, 400 Ah bank.



Caution!

When 2 or more batteries / battery strings are connected in parallel and are then connected to an Inverter Charger (See Figs. 4.3 and 4.4 given above), attention should be paid to the manner in which the Inverter Charger is connected to the battery bank. Please ensure that if the Positive output cable of the Inverter Charger (Cable "A") is connected to the Positive battery post of the first battery (Battery 1 in Fig. 4.3) or to the Positive battery post of the first battery string (Battery 1 of String 1 in Fig. 4.4), then the Negative output cable of the Inverter Charger (Cable "B") should be connected to the Negative battery post of the last battery (Battery 4 as in Fig. 4.3) or to the Negative Post of the last battery string (Battery 4 of Battery String 2 as in Fig. 4.4). This connection ensures the following:

- The resistances of the interconnecting cables will be balanced.
- All the individual batteries / battery strings will see the same series resistance.
- All the individual batteries will charge at the same charging current and thus, will be charged to the same state at the same time.
- None of the batteries will see an overcharge condition.

If the Positive output cable of the Inverter Charger (Cable "A") is connected to the Positive battery post of the first battery (Battery 1 in Fig. 4.3) or to the Positive battery post of the first battery string (Battery 1 of String 1 in Fig. 4.4), and the Negative output cable of the Inverter Charger (Cable "B") is connected to the Negative battery post of the first battery (Battery 1 as in Fig. 4.3) or to the Negative Post of the first battery string (Battery 1 of Battery String 1 as in Fig. 4.4), the following abnormal conditions will result:

- The resistances of the connecting cables will not be balanced.
- The individual batteries will see different series resistances.
- All the individual batteries will be charged at different charging current and thus, will reach fully charged state at different times.
- The battery with lower series resistance will take shorter time to charge as compared to the battery which sees higher series resistance and hence, will experience over charging and its life will be reduced.

Sizing Inverter Battery Bank

The following basic rules are used to determine the size of the battery bank:

- Active Power in Watts (W) = Voltage in Volts (V) x Current in Amperes (A) x Power Factor **Formula 1**
- For an inverter running from a 12V battery system, the DC current required from the 12V batteries is the AC power delivered by the inverter to the load in Watts (W) divided by 10 **Formula 2**
- Energy required from the battery = DC current to be delivered (A) x time in Hours (H) **Formula 3**
- As a Rule of Thumb, Ah capacity of the batteries required = 2 x Energy required from the battery **Formula 4**





SECTION 4 | Installation

An example of this calculation for a 12V inverter is given below:

Let us say that the total continuous AC Watts delivered by the 12V inverter = 1500W.

Then, using Formula 2 above, the DC current to be delivered by the 12V batteries = $1500W \div 10 = 150$ Amperes.

Next, the energy required by the load in Ampere Hours (Ah) is determined:

For example, if the load is to operate for 3 Hours, then as per Formula 3 above, the energy to be delivered by the 12V batteries = 150 Amperes \times 3 Hours = 450 Ampere Hours (Ah).

Finally, as per Rule of Thumb at Formula 4, the Ah capacity of the batteries should be twice the energy required by the load in Ah = $450 \text{ Ah} \times 2 = 900 \text{ Ah}$.

DC Input Power Terminals

Custom made DC input terminals using M9 Nut / Bolt arrangement have been provided for connecting DC input cables (10, 11 in Fig 3.1 to 3.3). The terminals are protected by plastic covers.

Important Wiring/Cabling Information

Although wires and cables are good conductors of electric current, they do have some resistance, which is directly proportional to the length and inversely proportional to the thickness (diameter) i.e. resistance increases in thinner and longer wires. Current flowing through resistance produces heat. Cables and wires are covered with insulating material that can withstand a specified temperature of the conductor under specified conditions. To ensure that the insulation is not damaged due to excessive overheating, each wire size has a maximum allowable current carrying capacity called "Ampacity" which is specified by NEC Table 31.15 (B) (17). Further, NEC also specifies that wire size should be based on Ampacity - 1.25 times the rated current flow.

Resistance of wires and cables produces another undesirable effect of voltage drop. Voltage drop is directly proportional to the resistance and the value of current flow. Voltage drop produces loss of power in the form of heat. In addition, excessive voltage drop from the battery to the inverter may prematurely shut down the inverter due to activation of the Low Input Voltage Protection Circuitry of the inverter ($10.5 \pm 0.3V$). DC cables should be sized to ensure maximum voltage drop is limited to less than 5%.

Effects of low voltage on common electrical loads are given below:

Lighting Circuits – Incandescent and Quartz/Halogen: Loss in light output because the bulb not only receives less power, but the cooler filament drops from white-hot towards red-hot, emitting much less visible light.

Lighting Circuits – Fluorescent: Voltage drop causes an early proportional drop in light output.

AC Induction Motors: These are commonly found in power tools, appliances, etc. They exhibit very high surge demands when starting. Significant voltage drop in these circuits may cause failure to start and possible motor damage.





SECTION 4 | Installation

Requirement of Fuse in Battery Connection

A battery is a very large source of current. If there is a short circuit along the length of the cables that connect the battery to the inverter, thousands of Amperes of current can flow from the battery to the point of shorting and that section of the cable will overheat, the insulation will melt and is likely to cause fire. To prevent occurrence of hazardous conditions under short circuit, fuse with Ampere rating \geq the maximum continuous current drawn by the inverter but \leq the Ampacity of the connecting cable should be used in the battery connection. The fuse should be fast acting Class-T or Marine Rated Battery Fuse Type MRBF. Rating of fuse is shown in Table 4.2 below. The fuse should be installed as close to the Battery Positive terminal as possible, preferably within 7". Please note that this fuse is required to protect the cable run from the battery to the inverter against short circuit. The inverter has its own internal DC side fuse(s) for internal DC side protection.

Making DC Side Connections

Recommended cable and fuse sizes for connecting battery are given in Table 4.2. The maximum current for cable sizing / fuse rating has been considered at 1.25 times rated continuous current draw at the rated output power.

Table 4.2 Recommended Cable and Fuse Sizes for Battery Connection

Model No.	Rated DC Input Current	Cable Size ¹ (Ampacity)	Max Fuse Size ²	Distance between Inverter, Battery and % Voltage Drop ³			Samlex Fuse (Optional)	Samlex Cable + Fuse Kit (Optional)
				3 ft.	6 ft.	10 ft.		
SAM-1000-12	100A	AWG#4 (160A)	100 to 150A	1.2%	2.4%	4.0%	DC-FA-100	DC-1000-KIT
SAM-1500-12	150A	AWG#2 (215A)	200A	1.2%	2.3%	3.8%	DC-FA-200	DC-2000-KIT
SAM-2000-12	200A	AWG#2/0 (329A)	300A	0.8%	1.5%	2.5%	DC-FA-300	DC-2500-KIT
SAM-3000-12	300A	AWG#4/0 (446A)	400A	0.7%	1.4%	2.4%	DC-FA-400	DC-3500-KIT

NOTES:

1. Cable Size

- As per NEC, size is based on Ampacity \geq 1.25 times the rated DC Input Current
- Conductor / Insulation rating : 105 °C

2. Fuse Size

- Type: Class-T or Marine Rated Battery Fuse (MRBF)
- The rating of the fuse should not exceed the Ampacity of the Cable

3. Distance between Inverter and Battery and % Voltage Drop

- Voltage drop is calculated based on length of cable = 2 x Distance to consider total length of Positive and Negative cables
- % drop is calculated with respect to rated battery voltage of 12.5V





SECTION 4 | Installation



Caution!

- Please ensure that the recommended external fuse specified in Table 4.2 above (Fuse is not supplied) is installed in series with the Positive cable and is as close to the Battery (+) terminal as possible (preferably within 7”).
- Please ensure that all the connections are tight. Loose connections may cause overheated wires and melted insulation.

AC Side Connections

See typical installation diagram at Fig 4.0, page 7.

General Information

1. The metal chassis of the inverter and the Grounding Terminal of the NEMA5-15R outlet(s) are internally bonded (connected) to the Negative DC Input Terminal on the inverter. In a vehicle / boat, the Negative Terminal of the battery is bonded to vehicle chassis / boat's hull. Hence, the metal chassis of the inverter and the AC loads will be automatically grounded (bonded to the vehicle chassis / boat's hull).
2. The Line and Neutral Terminals of the NEMA5-15R AC outlets are isolated from its Grounding Terminal. Thus, the metal chassis of the AC loads and the metal chassis of the inverter will also be isolated from the Line and Neutral. The Grounding Terminal of the AC outlet is connected to the input section of the Electronic Ground Fault Protection Circuit on the Power Circuit Board. Due to the above implementation, the voltage on the Neutral and Line Terminals of the AC outlet with respect to the chassis of the inverter / chassis of the AC loads will be pulsing DC voltage with average DC value of up to 50V (will read 75 VAC on AC scale of the Voltmeter because of pulsing nature of DC voltage). **DO NOT TOUCH THE NEUTRAL TERMINAL / NEUTRAL CONDUCTORS!**

Connecting AC Loads

AC output of the inverter is fed through NEMA5-15R outlets. Details are given in the Table 4.3 below:

TABLE 4.3 Details AC Output Connections

Model No.	Rated Output Power ¹ of the Inverter	Rated Output Current (Rated Output Power ÷ 115VAC)	NEMA5-15R ² Outlet (2, Figs 3.1, 3.2)	NEMA5-15R ² outlet (2, Fig 3.2) each with 15A Breaker (4, Fig 3.2)
SAM-1000-12	1000 VA ¹	8.7A	2	-
SAM-1500-12	1500VA ¹	13.0A	2	-
SAM-2000-12	2000VA ³	17.4A ³	-	3
SAM-3000-12	3000VA ³	26.0A ³	-	3





SECTION 4 | Installation

NOTES FOR TABLE 4.3

1. Power shown in the Table above is the Apparent Power in Volt Amps (VA). Active Power in Watts = Apparent Power in VA x Power Factor of the AC load. For resistive type of AC loads, the Power Factor is 1 and for these types of loads, Apparent Power in "VA" = Active Power in "Watts". Power ratings shown in the Specifications on page 24 are applicable for Resistive Load and hence, Watts = VA
2. Each NEMA5-15R outlet is rated at maximum current capacity of 15A and power of 1725VA at 115VAC
3. **CAUTION!** For SAM-2000-12 and SAM-3000-12, the full rated power cannot be drawn from 1 NEMA5-15R outlet as each outlet is rated for only 15A (1725VA) and is protected by 15A breaker. If a single load rated at > 1725VA is required to be powered, output from 2 NEMA5-15 outlets should be paralleled and then fed to this load. If a load > 1725VA / 15A is powered from a single breaker protected NEMA5-15R outlet, its 15A breaker will trip (pops out) and will have to be reset manually (pushed in).



Caution!

1. **DO NOT** connect to AC distribution wiring where the Neutral is bonded to Ground. The inverter will see this as abnormal condition of Ground Fault and will shut down.
2. The AC output from this inverter should **NOT** be connected in parallel with another AC source like grid / generator / another inverter - **SEVERE DAMAGE WILL OCCUR!**
3. If the AC output from this inverter is required to be fed to an AC Distribution Panel / Sub Panel for backup AC power, a suitable Transfer Switch like Samlex America Transfer Switch Model No. STS-30 should be used. The Transfer Switch will prevent parallel operation of AC output of this inverter with the other AC source.

Sizing Chart for Typical Loads that Require High Starting Surge

The manufacturers' specifications for power rating of appliances and devices indicate only the Running Power required. The Surge Power required by some specific types of devices as explained above has to be determined by actual testing or by checking with the manufacturer. This may not be possible in all cases and hence, can be guessed at best, based on some general Rules of Thumb.

Table 4.4 lists some common loads that require high surge power on start up. A "Sizing Factor" has been recommended against each which is a Multiplication Factor to be applied to the rated running Watt rating of the load to arrive at the Continuous Power Rating of the inverter (**Multiply the running Watts of the device/ appliance by the Sizing Factor to arrive at the size of the inverter**).



SECTION 4 | Installation

TABLE 4.4: INVERTER SIZING FACTOR

Type of Device or Appliance	Inverter Sizing Factor ¹
Air Conditioner / Refrigerator / Freezer (Compressor based)	5
Air Compressor	4
Sump Pump / Well Pump / Submersible Pump	3
Dishwasher / Clothes Washer	3
Microwave (where rated output power is the cooking power)	2
Furnace Fan	3
Industrial Motor	3
Portable Kerosene / Diesel Fuel Heater	3
Circular Saw / Bench Grinder	3
Incandescent / Halogen / Quartz Lamps	3
Laser Printer / Other Devices using Quartz Lamps for heating	4
Photographic Strobe / Flash Lights ²	4

NOTES FOR TABLE 4.4

1. Multiply the Running Active Power Rating {Watts} of the appliance by this Factor to arrive at the Continuous Power Rating of the inverter for powering this appliance.
2. For Photographic Strobe / Flash Unit, the surge power of the inverter should be > 4 times the Watt Sec rating of photographic strobe / flash unit.

Limiting Electro-Magnetic Interference (EMI)

This unit contains internal switching devices that generate conducted and radiated electromagnetic interference (EMI). The EMI is unintentional and cannot be entirely eliminated. The magnitude of EMI is, however, limited by circuit design to acceptable levels to provide reasonable protection against harmful interference. This unit can conduct and radiate radio frequency energy and, if not installed and used in accordance with the instruction manual, may cause harmful interference to radio communications. The effects of EMI will also depend upon a number of factors external to the unit like proximity of the unit to the EMI receptors, types and quality of connecting wires and cables etc. EMI due to factors external to the unit may be reduced as follows:

- Ensure that the unit is firmly grounded to the ground system of the building or the vehicle.
- Locate the unit as far away from the EMI receptors like radio, audio and video devices as possible.
- Keep the DC side wires between the battery and the unit as short as possible.
- Do not keep the battery wires far apart. Keep them taped together to reduce their inductance and induced voltages. This reduces ripple in the battery wires and improves performance and efficiency.





SECTION 4 | Installation

- Shield the DC side wires with metal sheathing / copper foil /braiding; - Use coaxial shielded cable for all antenna inputs (instead of 300 ohm twin leads) - Use high quality shielded cables to attach audio and video devices to one another.
- Limit operation of other high power loads when operating audio/video equipment.

Buzzing Sound in Audio Systems

Some inexpensive sound stereo systems and “Boom Boxes” may emit a buzzing sound from their speakers when operated from this unit. This is likely to occur because the power supply in the electronic device does not adequately filter higher frequency harmonics generated by Modified Sine Wave produced by this unit. The solution is to use higher quality sound system that incorporates higher quality of interference suppression in its power supply.





SECTION 5 | Operation

Connecting Loads, Switching ON & Switching OFF

Connecting Loads

1. Make sure that single load or the combined load requirement of your equipment does not exceed the inverter's output rating.
2. Switch OFF the inverter.
3. Switch OFF the load.
4. Plug the cord(s) from the load(s) into the AC receptacle(s) of the inverter
5. Switch ON the inverter. Wait for a few seconds.
6. The GREEN LED indicator "Power" (6, Fig 3.1 to 3.3) will be lit to indicate that the inverter is operating normally.
7. Switch ON the load(s).

Switching ON

1. Switch OFF the load connected to the inverter. Avoid switching ON the inverter with load in ON condition.
2. Switch ON the inverter, wait for a few seconds and then switch ON the load.
3. When using high capacitive loads with inadequate inrush current limiting like cheaper quality of Compact Fluorescent Lamps (CFL) etc., wait for 10 seconds before switching ON such loads. If the inverter is switched ON with these types of loads in ON condition, the inverter may shut down or the loads may not switch ON. Sometimes, adding a small resistive load (like incandescent lamp) in parallel with such devices may prevent such shut down.

Switching OFF

1. Switch OFF the load connected to the inverter
2. Switch OFF the inverter. Please note that on switching OFF, the GREEN LED "Power" (6, Fig. 3.1, 3.2, 3.3) will extinguish slowly.

Remote Control Model SAM-RC (optional)

An optional wired Remote Control Model SAM-RC is available. It comes with 3M, RJ-45 cable. It can be used to Switch ON and switch OFF the inverter and also displays the operational status of the inverter using colored LEDs. Plug the Remote Control Modular Plug into the Modular Jack (3 - Fig 3.1, 3.2, 3.3). See typical installation diagram at Fig 4.0, page 7. Refer to separate Owner's Manual provided with the Remote for further details of the remote's operation.



Caution!

NOTE: For switching ON and switching OFF the inverter using optional Remote Control SAM-RC, the main ON/OFF Switch on the inverter should be in OFF position.





SECTION 5 | Operation

If the ON/OFF Switch on the inverter is left in ON position, the inverter cannot be switched OFF using Remote Control. The Remote Control will, however, continue to display the Status of Operation.

Note: When optional Remote Control SAM-RC is used to switch OFF the unit, the GREEN LED "Power" (6-Fig 3.1, 3.2 & 3.3) takes 30 to 45 secs to extinguish if there is no load connected to the inverter. If a load is present, the LED will extinguish within a very short time.

Rated Versus Actual Current Draw of Equipment

Most electrical tools, appliances and audio/video equipment have labels that indicate the power consumption in Amps or Watts. Be sure that the power consumption of the item you wish to operate is less than inverter's power (if the power consumption is rated in Amps AC, simply multiply by the AC Volts (115) to determine the approximate wattage). The inverter will shut down if it is overloaded. The overload must be removed before the inverter will restart. Resistive loads are the easiest for the inverter to run. However, larger resistive loads, such as electric stoves or heaters, usually require more wattage than the inverter can deliver. Inductive loads, such as TV's and stereos, require more current to operate than do resistive loads of the same wattage rating. Induction motors, as well as some televisions, may require 2 to 6 times their wattage rating to start up. The most demanding in this category are those that start under load, such as compressors and pumps. To restart the unit after a shutdown due to overloading, remove the cause of overload, turn the power switch OFF, wait for at least 3 minutes and then switch ON again.





SECTION 6 | Protections Monitoring & Trouble-Shooting

NOTE: Please refer to Table 6.1 for status of monitoring LEDs and Buzzer for various protections / operational conditions explained below.

Over Temperature Protection

The unit is cooled by load-controlled fan. In case the fan fails or if the cooling is inadequate due to higher ambient temperature or restricted airflow, the temperature of hot spot inside the inverter will exceed the safe temperature threshold of 88°C to 115°C and the unit will automatically shut down. Yellow LED "Input Fault" will be ON & Green LED "Power" will be OFF. The unit will reset automatically on cooling down 10°C to 15°C below threshold.

Low DC Input Voltage Protection

This condition is not harmful to the inverter but could damage the 12 V battery. The inverter automatically shuts down when input voltage drops to $10.5 \pm 0.3V$. Yellow LED "Input Fault" will be ON, Green LED "Power" will be OFF and buzzer alarm will be sounded. It will reset automatically when input voltage is restored to $> 11.5V$.

High DC Input Voltage Protection

The inverter will automatically shut down when the input voltage exceeds $15.5 V \pm 0.2V$. Input voltage exceeding 16 volts could damage the inverter. Yellow LED "Input Fault" will be ON and Green LED "Power" will be OFF. Auto-reset at $< 15.5V \pm 0.2V$.

Overload / Short Circuit / Ground Fault Protection

The inverter will automatically shut down due to (a) short circuit conditions, (b) when the continuous / surge power exceeds rated watts and, (c) Ground Fault. The Red LED "Overload" will be ON and Green LED "Power" will also be ON. The unit will latch in shut down condition. To reset, switch OFF the ON/OFF switch, wait for 3 minutes and switch ON again.

In models SAM-2000-12 and SAM-3000-12, if load with power draw $> 1725 VA/15A$ is connected to 1 NEMA5-15R outlet, the 15A breaker on top of that receptacle will trip (pop out). Reset manually (push in).

Info

Some high capacitive loads like Compact Fluorescent Lamps (CFL) or Switched Mode Power Supply (SMPS) will draw very high inrush current due to very fast voltage rise of the square wave nature of the Modified Sine Wave and shut down the inverter. Try using a small resistive load in parallel to reduce high inrush current and prevent overloading.





SECTION 6 | Protections Monitoring & Trouble-Shooting

Low Input Voltage Buzzer Alarm

A buzzer alarm will sound when the voltage at the input terminals of the inverter drops to $10.8V \pm 0.3V$. This is an indication that either the battery terminal voltage has dropped due to its discharged condition and needs to be re-charged or there is an excessive voltage drop across the wires connecting the inverter to the battery (due to use of thinner and longer length of wires that will produce higher voltage drop at higher loads or due to loose connections). The user should stop operation of the electronic device at this time since the inverter will shut down automatically shortly thereafter, when the input voltage at the inverter further drops to $10.5V \pm 0.3V$. In case the alarm is due to the discharged condition of the battery, start your engine to recharge the battery / use an appropriate battery charger.

Info

It is normal for the alarm to sound while the unit is being connected to or disconnected from the DC power source. This is not indicative of a problem.

Ground Fault Protection - General

Due to loss of insulation as a result of aging of insulating materials, accident or malfunction, voltage source inside an electrical device can get connected to its metal chassis. If the energized metal chassis is touched by a person standing on Earth Ground (considered to be at 0V), the person will get a shock due to current leaked through the body to Earth Ground (called Leakage Current). Such condition is called "Ground Fault". As this Leakage Current is diverted to Earth Ground, it does not return to the electrical power source supplying the AC device. Severity of electrical shock will depend upon the value of the fault voltage on the metal chassis and the impedance in the current path to Earth Ground, primarily the impedance of the human body (100 k Ω when dry and 1 k Ω when wet). Human body can tolerate leakage current of up to 5mA for 15 to 30 msec.

Ground fault protection in this inverter is provided as follows:

- The Line and Neutral terminals of the AC outlet are isolated from its grounding terminal. Thus, the metal chassis of the AC loads will also be isolated from the Line and Neutral.
- The grounding terminal of the AC outlet is connected to the input section of the Electronic Ground Fault Protection Circuit on the power circuit board.
- **Due to the above implementation, the Neutral voltage will be pulsing DC voltage with average DC value of up to 50VDC with respect to the metal chassis of the AC loads / metal chassis of the inverter (will read 75 VAC on the AC scale of the Voltmeter because of pulsing nature of DC Voltage). Similarly, the Line voltage will also be up to 75V with respect to the metal chassis of the AC loads / metal chassis of the inverter . Do not touch the Line / Neutral!**
- If the metal chassis of the load develops a Ground Fault condition, up to 75V will be fed to the Electronic Ground Fault Protection Circuit and the AC output of the inverter will shut





SECTION 6 | Protections Monitoring & Trouble-Shooting

down. Red LED "Overload" will be ON and Green LED "Power" will also be ON. The unit will latch in shutdown condition. To reset, switch OFF the ON/OFF switch, wait for 3 minutes and switch ON again.

- **Ground Fault protection will also operate if the Neutral and ground of the AC output of the inverter are connected (bonded) intentionally like in Service Entrance / Load Center for AC distribution wiring.**



Caution!

Connecting to utility AC distribution wiring with Neutral to Ground connection (bond) is not permitted. In AC utility distribution wiring, the Neutral conductor is connected (bonded) to the Equipment Grounding Conductor at the Load Center / Service Entrance. Both these conductors are then bonded to the Earth Ground (Ground Rod). Thus, if the output of the inverter is connected to the utility AC distribution wiring, it will see a Neutral to Ground connection and the inverter will trip due to activation of the Ground Fault Protection Circuit as explained above.

Failure to Start Some Devices on Load

Some high capacitance loads like Compact Fluorescent Lamp (CFL) or Switched Mode Power Supply (SMPS) will shut down the inverter under overload condition if the inverter is switched ON with these loads in ON condition. However, if these loads are switched OFF first and switched ON only after around 10 sec after the inverter is switched ON (as already recommended under switching ON procedure), the inverter may not shut down. Hence, do not switch ON the inverter with such loads in ON condition.

Monitoring of Operational Status & Protections

Normal / abnormal behavior can be monitored by observing Green LED (6, Power), Yellow LED (5, Input Fault), Red LED (7, Fault) and Buzzer. Details are given in Table 6.1 below:

Table 6.1 Protections and Monitoring

Operating Condition/ Protection	Threshold/ Reason	GREEN LED (6, Power)	YELLOW LED (5, Input Fault)	RED LED (7, Fault)	Buzzer	Remedy/Reset
Normal	-	ON	OFF	OFF	OFF	-
Low DC Input Alarm	10.8V ± 0.3V	ON	OFF	OFF	ON	Check battery voltage and input voltage drop. Auto reset when voltage > 10.5 V ± 0.3V.
No Output due to Low DC Input Voltage shutdown	10.5V ± 0.3V	OFF*	ON	OFF	ON	Check battery voltage and input voltage drop. Auto reset when voltage rises to >11.5V.
No output due to High DC Input Voltage Shut Down	15.5 ± 0.2V	OFF*	ON	OFF	OFF	Check charger voltage. Auto reset when voltage < 15.5V.





SECTION 6 | Protections Monitoring & Trouble-Shooting

Operating Condition/Protection	Threshold/Reason	GREEN LED (6, Power)	YELLOW LED (5, Input Fault)	RED LED (7, Fault)	Buzzer	Remedy/Reset
No Output due to High Temperature Shut Down	Internal hot spot > 88°C to 115°C	OFF*	ON	OFF	OFF	Check ambient temperature, fan and loss of cool replacement air . Auto reset when hot spot cools down 10°C to 15°C below the threshold.
No output due to Over Load Shut Down	Output power is > Continuous / Surge Rating	ON	OFF	ON	OFF	Check starting surge rating of load. If happens with low power CFL or SMPS, try adding small resistive load. If happens when inverter is switched ON with high capacitance load already in ON condition, try switching ON the load 10 sec after the inverter has been switched ON. Manual Reset. Unit will latch in shut down condition. To reset, switch OFF the ON/OFF Switch, wait for 3 minutes and switch ON again.
No output due to Ground Fault Shut Down	Neutral or Line connected to Ground	ON	OFF	ON	OFF	Check if there is Neutral to Ground bond or Ground Fault. Manual Reset. Unit will latch in shut down condition. To reset, switch OFF the ON/OFF Switch, wait for 3 minutes and switch ON again.
No output	No DC Input Voltage due to Blown DC Input Fuse	OFF	OFF	OFF	OFF	Check fuse in the 12V battery input line.
For SAM-2000-12, SAM-3000-12: No output from outlet to which load is connected	15A breaker on top of the outlet has tripped due to load > 1725 VA/15A	ON	OFF	OFF	OFF	Remove the load and reset the breaker (push in). Ensure load connected to 1 outlet is < 1725 VA/15A. Use 2 outlets in parallel if load is > 1725 VA.

* On activation of protection, the Green LED will start dimming slowly and will extinguish after some time.





SECTION 7 | Specifications

INVERTER PARAMETER	SAM-1000-12	SAM-1500-12	SAM-2000-12	SAM-3000-12
INPUT				
BATTERY SYSTEM VOLTAGE	12 VDC	12 VDC	12 VDC	12 VDC
NOMINAL INPUT VOLTAGE	12.5 VDC	12.5 VDC	12.5 VDC	12.5 VDC
INPUT VOLTAGE RANGE	> 10.5 VDC to < 15.0 (± 0.5) VDC			
INPUT CURRENT AT CONTINUOUS POWER	100A	150A	200A	300A
INPUT CURRENT AT NO LOAD	0.5 to 0.6A	0.65 to 0.75A	0.75 to 0.85A	0.85 to 0.95A
OUTPUT				
OUTPUT VOLTAGE WAVE FORM	Modified Sine Wave			
OUTPUT VOLTAGE	115 VAC			
OUTPUT VOLTAGE REGULATION	+ 10% / - 0%			
OUTPUT FREQUENCY	60 Hz ± 5%			
OUTPUT POWER, CONTINUOUS (RESISTIVE LOAD)	1000W	1500W	2000W	3000W
OUTPUT POWER, SURGE (<1 SEC., RESISTIVE LOAD)	2000W	3000W	4000W	6000W
PEAK EFFICIENCY (AT 50% OF CONTINUOUS POWER)	90%	90%	90%	90%
PROTECTIONS				
LOW INPUT VOLTAGE ALARM	YES. 10.8 VDC ± 0.3 VDC			
LOW INPUT VOLTAGE SHUTDOWN	10.5 VDC ± 0.3 VDC			
HIGH INPUT VOLTAGE SHUTDOWN	YES. > 15.5 VDC ± 0.2 VDC			
OVERLOAD AND GROUND FAULT SHUT DOWN	YES. (Latches in shutdown condition. Manual reset by switching OFF and switching ON the ON/OFF Switch)			
OVER TEMPERATURE SHUTDOWN	Internal Hot Spot 88°C - 115°C. Auto-reset when cools down by 10°C to 15°C			
COOLING FAN, LOAD CONTROLLED, ON AT:	28 to 32W	90 to 110W	90 to 110W	90 to 110W
GROUND FAULT PROTECTION	Yes. Shutdown.	Yes. Shutdown.	Yes. Shutdown.	Yes. Shutdown.
DC INPUT FUSE, 32V	120A (4 x 30A)	240A (8 x 30A)	350A (10 x 35A)	480A (16 x 30A)
CONNECTIONS				
DC INPUT CONNECTIONS	Nut & Bolt, M9			
AC OUTPUT - NO. OF NEMA5-15R RECEPTACLES	2	2	3*	3*
REMOTE CONTROL PORT	YES	YES	YES	YES
GENERAL				
OPERATING TEMPERATURE RANGE	0°C to 25°C / 32°F to 77°F at 100% loading; 26°C to 35°C / 78.8°F to 95°F at 80% loading			
OPERATING HUMIDITY	< 80%			
NEUTRAL TO CHASSIS BONDING	No. Neutral is floating			
DIMENSIONS (W x D x H) mm	180 x 250 x 59	202 x 283 x 84	202 x 345 x 84	202 x 420 x 84
DIMENSIONS (W x D x H) inches	7.1 x 9.84 x 2.32	7.95 x 11.14 x 3.3	7.95 x 13.58 x 3.3	7.95 x 16.53 x 3.3
WEIGHT, KG.	1.69	3.2	3.9	5.5
WEIGHT, LBS.	3.72	7.1	8.5	11.8

Specifications are subject to change without notice.

* Each of the 3 NEMA5-15R Receptacles is protected with 15A breaker.





7. SPÉCIFICATIONS

PARAMÈTRE ONDULEUR	SAM-1000-12	SAM-1500-12	SAM-2000-12	SAM-3000-12
ENTRÉE				
TENSION DE SYSTÈME DE BATTERIE	12 VCC	12 VCC	12 VCC	12 VCC
TENSION D'ENTRÉE NOMINALE	12,5 VCC	12,5 VCC	12,5 VCC	12,5 VCC
PLAGE DE TENSION D'ENTRÉE	> 10,5 VCC à < 15,0 (± 0.5) VCC			
COURANT D'ENTRÉE À PUISSANCE CONTINUE	100A	150A	200A	300A
COURANT D'ENTRÉE SANS CHARGE	0,5A à 0,6A	0,65A à 0,75A	0,75A à 0,85A	0,85A à 0,95A
EFFICACITÉ MAXIMALE (À 50% DE PUISSANCE CONTINUE)	90%	90%	90%	90%
SORTIE				
FORME D'ONDE DE SORTIE	Onde Sinusoïdale Modifiée			
TENSION DE SORTIE	115 VCA			
FRÉQUENCE DE SORTIE	60 Hz ± 5%			
PUISSANCE DE SORTIE, CONTINUE (CHARGE RÉSISTIVE)	1000W	1500W	2000W	3000W
PUISSANCE DE SORTIE, SURPUISSANCE (<1 SEC., CHARGE RÉSISTIVE)	2000W	3000W	4000W	6000W
RENDEMENT MAX. (À 50% DE PUISSANCE CONTINUE)	90%	90%	90%	90%
PROTECTIONS				
ALARME DE SOUS-TENSION	Oui. 10,8 VCC ± 0,3 VCC			
FERMETURE DE SOUS-TENSION	10,5 VCC ± 0,3 VCC			
FERMETURE DE SURTENSION	Oui. 15,5 VCC ± 0,2 VCC			
FERMETURE DE SURCHARGE ET DE FUITE À LA TERRE	Oui. (Fermetures en état d'arrêt. Réarmement manuel par Mise hors tension et activation de l'interrupteur ON / OFF)			
FERMETURE DE SURCHAUFFE	Hot spot interne de 88°C - 115°C. Auto-réinitialisée lorsque se refroidit de 10°C à 15°C			
LA CHARGE DE REFROIDISSEMENT DU VENTILATEUR CONTRÔLÉ, À:	28 à 32W	90 à 110W	90 à 110W	90 à 110W
GROUND FAULT PROTECTION	Yes. Shutdown.	Yes. Shutdown.	Yes. Shutdown.	Yes. Shutdown.
FUSIBLE D'ENTRÉE CC: 32V	120A (4 x 30A)	240A (8 x 30A)	350A (10 x 35A)	480A (16 x 30A)
CONNEXIONS				
ENTRÉE CC CONNEXIONS	Écrous et de boulons, M9			
SORTIE CA - NO. DE NEMA5-15R	2	2	3*	3*
GÉNÉRAL				
PLAGE DE TEMPÉRATURE DE FONCTIONNEMENT	0°C - 25°C / 32°F - 77°F à 100% loading; 26°C - 35°C / 78,8°F - 95°F à 80% loading			
HUMIDITÉ DE FONCTIONNEMENT	< 80%			
LIASON DU NEUTRE AU CHÂSSIS	No. Neutre est flottant.			
DIMENSIONS (L x L x H) MM	180 x 250 x 59	202 x 283 x 84	202x 345 x 84	202 x 420 x 84
DIMENSIONS (L x L x H) POUCES	7,1 x 9,84 x 2,32	7,95 x 11,14 x 3,3	7,95 x 13,58 x 3,3	7,95 x 16,53 x 3,3
POIDS	1,69 kg. 3,72 lbs.	3,2 kg. 7,1 lbs.	3,9 kg. 8,5 lbs.	5,5 kg. 11,8 lbs.

NOTE: Les spécifications pourraient changer sans avis

* Chacun des 3 NEMA5-15R réceptifs est protégé par disjoncteur 15A.





SECTION 8 | Warranty

2 YEAR LIMITED WARRANTY

SAM-1000-12, SAM-1500-12, SAM-2000-12 & SAM-3000-12 manufactured by Samlex America, Inc. (the "Warrantor") is warranted to be free from defects in workmanship and materials under normal use and service. The warranty period is 2 years for the United States and Canada, and is in effect from the date of purchase by the user (the "Purchaser").

Warranty outside of the United States and Canada is limited to 6 months. For a warranty claim, the Purchaser should contact the place of purchase to obtain a Return Authorization Number.

The defective part or unit should be returned at the Purchaser's expense to the authorized location. A written statement describing the nature of the defect, the date of purchase, the place of purchase, and the Purchaser's name, address and telephone number should also be included.

If upon the Warrantor's examination, the defect proves to be the result of defective material or workmanship, the equipment will be repaired or replaced at the Warrantor's option without charge, and returned to the Purchaser at the Warrantor's expense. (Contiguous US and Canada only)

No refund of the purchase price will be granted to the Purchaser, unless the Warrantor is unable to remedy the defect after having a reasonable number of opportunities to do so. Warranty service shall be performed only by the Warrantor. Any attempt to remedy the defect by anyone other than the Warrantor shall render this warranty void. There shall be no warranty for defects or damages caused by faulty installation or hook-up, abuse or misuse of the equipment including exposure to excessive heat, salt or fresh water spray, or water immersion.

No other express warranty is hereby given and there are no warranties which extend beyond those described herein. This warranty is expressly in lieu of any other expressed or implied warranties, including any implied warranty of merchantability, fitness for the ordinary purposes for which such goods are used, or fitness for a particular purpose, or any other obligations on the part of the Warrantor or its employees and representatives.

There shall be no responsibility or liability whatsoever on the part of the Warrantor or its employees and representatives for injury to any persons, or damage to person or persons, or damage to property, or loss of income or profit, or any other consequential or resulting damage which may be claimed to have been incurred through the use or sale of the equipment, including any possible failure of malfunction of the equipment, or part thereof. The Warrantor assumes no liability for incidental or consequential damages of any kind.

Samlex America Inc. (the "Warrantor")
www.samlexamerica.com





SECTION 8 | Warranty

GARANTIE LIMITEE SOUS 2 ANS

SAM-1000-12, SAM-1500-12, SAM-2000-12 et SAM-3000-12 fabriqués par Samlex America, Inc. (le « Garant ») sont garantis être non défectueux dans la conception et dans les matériaux, moyennant une utilisation et un service normaux. La période de garantie est de 2 ans pour les Etats-Unis et le Canada, et prend effet le jour de l'achat par l'utilisateur (« l'Acheteur »).

La garantie hors des Etats Unis et du Canada est limitée à 6 mois. Pour une réclamation concernant la garantie, l'Acheteur devra contacter le point de vente ou l'achat a été effectué afin d'obtenir un Numéro d'Autorisation pour le Retour.

La pièce ou l'unité défectueuse devra être retournée aux frais de l'acheteur au point de vente agréé. Une déclaration écrite décrivant la nature du défaut, la date et le lieu d'achat ainsi que le nom, l'adresse et le numéro de téléphone de l'Acheteur devront également être renseignés.

Si a l'examen de la demande par le Garant, le défaut est réellement le résultat d'un matériau ou d'un assemblage défectueux, l'équipement sera réparé ou remplacé gratuitement et renvoyé a l'Acheteur aux frais du

Garant. (Etats-Unis et Canada uniquement).

Aucun remboursement du prix d'achat ne sera accorde a l'Acheteur, sauf si le Garant est incapable de remédier au défaut après avoir eu plusieurs occasion de le faire. Le service de garantie doit être effectuée uniquement par le Garant. Toute tentatives de remédier au défaut par quelqu'un d'autre que le Garant rendent cette garantie nulle et sans effet. Il n'existe aucune garantie concernant les défauts ou dommages causés par une installation défectueuse ou inadaptée, par un abus ou une mauvaise utilisation de l'équipement, y compris, une exposition excessive a la chaleur, au sel, aux éclaboussures d'eau fraiche ou a l'immersion dans l'eau.

Aucune autre garantie express n'est accordée et il n'existe aucunes garanties qui s'étendent au delà des conditions décrites par la présente. Cette garantie est la seule garantie valable et reconnue par le Garant, et prédomine sur d'autres garantie implicites, y compris les garanties implicites liées a la garantie de qualité marchande, a l'usage des objectifs habituels pour lesquels de telles marchandises sont utilisées, ou l'usage pour un objectif particulier, ou toutes autres obligations de la part du Garant ou de ses employés et représentants.

Il ne doit pas exister de responsabilité ou autre de la part du Grant ou des ses employés et représentants, en ce qui concerne les blessures corporelles, ou les dommages de personne a personne, ou les dégâts sur une propriété, ou la perte de revenus ou de bénéfices, ou autres dommages collatéraux, pouvant être rapportés comme ayant survenus au cours de l'utilisation ou de la vente du matériel, y compris tous dysfonctionnements ou échecs du matériel, ou une partie de celui-ci. Le Garant n'assume aucune responsabilité concernant toutes sortes de dommages accidentels ou indirects.

Samlex America Inc. (le « Garant »)
www.samlexamerica.com

SAMLEX AMERICA INC. | 27





Notes

Lined area for notes with horizontal ruling lines.





Contact Information

Toll Free Numbers

Ph: 800 561 5885

Fax: 888 814 5210

Local Numbers

Ph: 604 525 3836

Fax: 604 525 5221

Website

www.samlexamerica.com

USA Shipping Warehouse

Kent WA

Canadian Shipping Warehouse

Delta BC

Email purchase orders to
orders@samlexamerica.com



samlexamerica®

