



Power. On Your Terms.



SimpliPhi AccESS Type I and II

INSTALLATION MANUAL

Optimized Energy Storage & Management for Residential & Commercial Applications Utilizing Efficient, Safe, Non-Toxic, Energy Dense Lithium Ferrous Phosphate (LFP) Chemistry

SimpliPhi Your Energy Security and Independence

and gain control of your own power.

SimpliPhi helps you manage your power as a personal resource. Anytime. Anywhere. SimpliPhi energy storage optimizes integration of any power generation source – solar, wind, generator – on or off grid and protects your home and mission-critical business functions from power outages and intermittency. SimpliPhi storage technology eliminates operating temperature constraints, toxic coolants and the risk of thermal runaway and fire. Safe lithium ferrous phosphate. No cobalt. No hazards.

SimpliPhi's battery technology utilizes the industry's most environmentally benign chemistry combined with proprietary architecture and power electronics (BMS) that eliminate the need for cooling or ventilation to create products that provide energy security and resiliency – all with a 98% efficiency rate.

SimpliPhi Power offers proprietary, commercially available energy storage and management systems that are safe, non-toxic, reliable, durable, efficient, highly scalable, and economical over the lifetime of the AccESS.

Table of Contents

- 1.0 – Important Safety Information** 4
 - 1.1 – Safety Instructions..... 4
 - 1.2 – Safety & Protective Features 5
 - 1.3 – Limitations of Use..... 7
 - 1.4 – Inverter/Charger Programming Settings 7
 - 1.5 – Explosive Gas Precautions 7
 - 1.6 – FCC Information to the User 7

- 2.0 – Product Description** 8
 - 2.1 – Overview..... 8
 - 2.2 – Specifications 8
 - 2.3 – Inside the AccESS NEMA-3R Rated Cabinet 9

- 3.0 – Pre-Installation** 12
 - 3.1 – PHI 3.5 Battery Performance Parameters and Sizing Calculations..... 12
 - 3.2 – System Sizing for Your Installation 12
 - 3.3 – Installation Tools and Materials 12
 - 3.4 – Installation Site Location 13
 - 3.5 – Clearance Requirements 13
 - 3.6 – Knock Out Locations 14
 - 3.7 – Pad Mounting 14

- 4.0 – Installation & Wiring** 15
 - 4.1 – Basic System Configuration Concepts 15
 - 4.2 – PHI 3.5 Battery Installation within the AccESS 16
 - 4.3 – Torque Values 16
 - 4.4 – Communications and Network Preparation 17
 - 4.5 – Wiring the AccESS..... 18
 - 4.6 – AccESS Optional Components/Accessories Installation..... 27

- 5.0 – Programming**..... 28
 - 5.1 – Depth of Discharge 28
 - 5.2 – Configuring the Schneider Electric Conext XW+..... 28
 - 5.3 – Operating Parameters Per Warranty 28

- 6.0 – SimpliPhi Technical Support**..... 33

- Appendix A – Schneider Electric Product Specifications 33

1.0 – Important Safety Information



1.1 – Safety Instructions

1. Before using the unit, read all instructions and cautionary markings on the unit, the PHI 3.5 Batteries, and all appropriate sections of this manual.
2. PHI 3.5 Batteries must be fully charged before commissioning the AccESS unit. Failure to do so will void the Warranty.
3. Use of accessories not recommended or sold by the manufacturer may result in a risk of fire, electric shock, or injury to persons and will void the Warranty.
4. Verify system settings are in compliance with the Battery Warranty and Battery Installation Manual (which take precedence). Violating Warranty conditions specified in these documents will void the Warranty on the PHI Batteries.
5. Consult the Integration Guide for Inverter Charge Controller programming settings for relevant warnings and notices. Violating Warranty conditions specified in those Inverter Integration Guides will void the Warranty on the whole AccESS unit, not just the Schneider Electric equipment. Contact SimpliPhi Power technical support regarding any inconsistencies with other referenced documents.
6. Each AccESS unit contains two or three PHI 3.5 Batteries. Although each PHI 3.5 Battery contains both a circuit breaker and an internal BMS with circuitry that protects the PHI 3.5 Battery cells from overcharge, over-discharge and extreme load amperage, the PHI 3.5 Batteries must always be installed with appropriate inverter charge controller settings and power electronics to protect the PHI 3.5 from open PV voltage and other high voltage charging sources. Do not attempt to replace existing power electronics without SimpliPhi's written approval. Failure to adhere to installation protocol will void the Warranty.
7. Verify polarity at all connections with a standard volt meter before 1) energizing the system and 2) turning the PHI 3.5 circuit breaker "ON/OFF" switch to the "ON" position. Reverse polarity at the PHI 3.5 Battery terminals will void the Warranty and destroy the PHI 3.5 Batteries.
8. PHI 3.5 Batteries pose some risk of shock or sparking during the installation and initial wiring and connection process. This is consistent with all other battery-based storage formats. Be sure to turn the built-in circuit breaker to the "OFF" position to minimize the risk of shock or sparks during the installation and commissioning of the system.
9. To avoid a risk of fire and electric shock, make sure that existing wiring is in good condition and that wire is not undersized. Do not operate the AccESS unit with damaged or substandard wiring.
10. Do not operate the AccESS unit if it has been damaged in any way during shipping or otherwise.
11. Only use a SimpliPhi approved LFP battery charger if ancillary charging is required before installation, testing or troubleshooting. Failure to use a SimpliPhi approved LFP battery charger will damage the PHI 3.5 Battery and void the Warranty.
12. To reduce the chance of short-circuits, always use insulated tools when installing or working with this equipment.
13. Remove personal metal items such as rings, bracelets, necklaces, and watches when working with electrical equipment.
14. The AccESS unit does not have any user-serviceable parts. Do not disassemble the inverter except where noted for connecting wiring and cabling. See your Warranty for instructions on obtaining service. Attempting to service the components inside the AccESS unit yourself may result in a risk of electrical shock or fire and void the Warranty. Internal capacitors remain charged after all power is disconnected – wait 10 minutes before servicing.
15. To reduce the risk of electrical shock, disconnect both AC and DC power from the AccESS unit before attempting any maintenance or cleaning or working on any components connected to the inverter. Putting the AccESS unit in Standby mode will not reduce this risk.



1.2 – Safety & Protective Features

1.2.1 – 80A Breaker

All PHI 3.5 Batteries within the AccESS unit are outfitted with an 80A hydraulic/magnetic circuit breaker. This breaker increases safety during shipping and installations and allows the PHI 3.5 Battery to effectively be turned “OFF” or “ON.” The breaker works in conjunction with the built-in battery management system (BMS) and creates additional safety, efficiency and functionality to the overall power storage system.

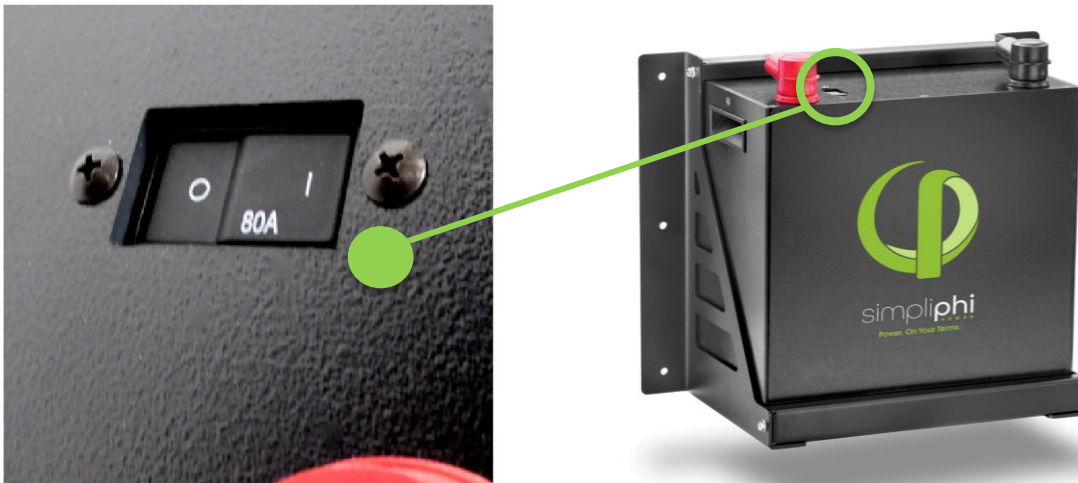

Figure 1.0 - PHI 3.5 kWh 48V Circuit Breaker



CAUTION: Circuit Breakers, Disconnects and Fuses should be employed throughout several points of a power storage and generation installation to effectively isolate and protect all components of the system to safeguard against faults, short circuits, polarity reversals or a failure of any component in the overall system. Fuses, breakers, wiring ratings and values should be determined by established standards and evaluated by certified electricians, licensed installers, and regional code authorities. Although each PHI 3.5 Battery contains both a circuit breaker and an internal BMS with circuitry that protects the Lithium Ferrous Phosphate cells from overcharge, over-discharge and extreme load amperage, the PHI 3.5 Batteries must always be installed with a charge controller and the appropriate settings to protect the PHI 3.5 Battery from open PV voltage and other high voltage charging sources. The PHI 3.5 Battery Management System (BMS) and internal circuit breaker alone will not protect the PHI 3.5 Batteries from these extreme electrical phenomena. Failure to adhere to installation protocol will void the Warranty.



CAUTION: Verify polarity at all connections with a standard volt meter before 1) energizing the system and 2) turning the PHI 3.5 circuit breaker “ON/OFF” switch to the “ON” position. **Reverse polarity** at the battery terminals will void the Warranty and destroy the PHI 3.5 Batteries.

PHI 3.5 Batteries pose some risk of shock or sparking during the installation and initial wiring and connection process. This is consistent with all other battery-based storage formats. Be sure to turn the built-in breaker to the “OFF” position to minimize the risk of shock or sparks during the installation and commissioning of the system. Use of insulated gloves, clothing and footwear is always recommended when working in close proximity to electrical devices. Cover, restrain or remove jewelry or conductive objects (metal bracelets, rings, belt buckles, metal snaps, zippers, etc.) when working with any electrical or mechanical device. Cover or restrain long hair and loose clothing when working with any electrical or mechanical device.

PHI 3.5 Batteries do not vent any harmful gasses, and do not require special ventilation or cooling.

PHI 3.5 Batteries are not capable of thermal runaway. If the cells are severely damaged due to physical abuse incurred outside of warranted specifications, which can cause electrolyte leakage and other failures, as with any PHI 3.5 Battery, the electrolyte can be ignited by an open flame. However, unlike other lithium ion batteries (LCO) there are no hazardous or toxic materials in the electrolyte or the material components of PHI 3.5 Batteries. See PHI 3.5 Installation Manual for details.

1.2.2 – Charging at Temperatures Below Freezing

It is important to take necessary steps to determine the temperature of the PHI 3.5 Battery prior to charging the battery, as the battery may otherwise be adversely impacted.



CAUTION: Do not attempt to charge the PHI 3.5 Battery below 32° F (0° C). Although cold temperatures do not harm PHI 3.5 Batteries, attempts to charge at subfreezing temperatures can adversely affect SOH and cycle life, and will void the Warranty. If the PHI 3.5 Battery must be charged below 32° F (0° C), the rate of charge must be at no more than 5% of the PHI 3.5 Battery's rated capacity (C/20).



CAUTION: Only use a SimpliPhi approved LFP charger if ancillary charging is required before installation, testing or troubleshooting. Failure to use a SimpliPhi approved LFP charger will damage the PHI 3.5 Battery and void the Warranty.

1.2.3 – Battery Management System (BMS)

The PHI 3.5 Batteries within the AccESS unit are manufactured utilizing Lithium Ferrous Phosphate (LFP) cells, which are produced under exclusive patented licensed technologies, as well as proprietary materials, architecture, assembly methods and battery management system (BMS). This assures the highest grade and quality, longest cycle-life, greatest efficiency and freedom from material impurities, toxicity and hazardous risk.

Each PHI 3.5 Battery within the AccESS unit contains circuitry that protects the Lithium Ferrous Phosphate cells from overcharge, over-discharge and extreme load amperage. If the values specified are exceeded, the protective circuitry will shut down the flow of electricity to/from the PHI 3.5 Batteries. In some cases, this will result in the need to re-initialize an inverter charger. Often, inverter system settings will be saved within the inverter memory storage and will not need to be reset. This is not an absolute standard but is common amongst most inverter chargers and should be anticipated if the PHI 3.5 Batteries go into a state of self-protection and shut down the flow of electricity. Refer to SimpliPhi's inverter integration guides for inverter charge controller settings or contact the inverter manufacturer.

1.2.4 – PHI 3.5 Battery Connection Terminals

The PHI 3.5 Batteries are equipped with two 3/8" threaded studs with a lock washer and nut. The red colored high temperature molded insert connection is for the positive lead. The black colored high temperature insert connection is for the negative lead.



CAUTION: Do not attempt to loosen the large brass nut at the base of the terminals.



CAUTION: Do not reverse polarity. It will void the Warranty. Use a volt meter to check polarity before connecting terminals.

Water Resistant Cable Boots are also included and will be in place when your units arrive. The boots are to be placed over the cable terminations and will stretch to form a water-resistant seal around the base of the molded inserts and terminal connections.

1.3 – Limitations of Use

The Conext XW+ Inverter/Charger built into the SimpliPhi Power AccESS is not intended for use in connection with life support systems or other medical equipment or devices.

1.4 – Inverter/Charger Programming Settings

The Schneider Electric Conext XW+ Inverter/Charger has a firmware limitation that creates a potential issue with Lithium-Ion batteries: the Low Battery Cut-Out Voltage (LBCO) setting is limited to 48V maximum. This value is below the recommended LBCO settings to maximize cycle-life of most Lithium-Ion batteries including PHI 3.5 Batteries. Per the Warranty, a 48V LBCO corresponds to 100% DoD and maintains a much more limited cycle life.

Until Schneider releases updated firmware to adjust this setting above 48V, this issue can be largely mitigated by setting the “Recharge Volts” above the desired LBCO thresholds as outlined in the Inverter Programming Settings. Therefore, systems that do not rely solely on renewable energy (i.e. grid tied systems, AGS systems) will typically start charging the PHI 3.5 Batteries once the recharge voltage level is reached, preventing further discharge of the PHI 3.5 Batteries and thus optimizing cycle-life.



1.5 – Explosive Gas Precautions

This equipment is not ignition protected. To prevent fire or explosion, do not install this product in locations that require ignition-protected equipment. This includes any confined space containing vented batteries, or flammable chemicals such as, natural gas (NG), liquid petroleum gas (LPG) or gasoline (Benzine/Petrol).

Do not install in a confined space with machinery powered by flammable chemicals, or storage tanks, fittings, or other connections between components of fuel or flammable chemical systems.

1.6 – FCC Information to the User

The Schneider equipment has been tested and found to comply with the limits for a Class B digital device, pursuant to part 15 of the FCC Rules. These limits are designed to provide reasonable protection against harmful interference in a residential installation. This equipment generates, uses and can radiate radio frequency energy and, if not installed and used in accordance with the instructions, may cause harmful interference to radio communications. However, there is no guarantee that interference will not occur in a particular installation. If this equipment does cause harmful interference to radio or television reception, which can be determined by turning the equipment off and on, the user is encouraged to try to correct the interference by one or more of the following measures:

- Reorient or relocate the receiving antenna.
- Increase the separation between the equipment and the receiver.
- Connect the equipment to a circuit different from that to which the receiver is connected.
- Consult the dealer or an experienced radio/TV technician for help.

2.0 – Product Description

2.1 – Overview

The SimpliPhi AccESS offers industry leading renewable energy storage technology to provide energy security and power resiliency into a pre-assembled, pre-programmed system that is suitable for installation inside and outside. The AccESS serves all of the common residential scale renewable energy applications: Off Grid, Grid Tied Back Up, Self Consumption – with Zero Export.

2.2 – Specifications

Please review Table 1.0 below for AccESS unit specifications, including physical dimensions, Warranty period, and technical data.

Table 1.0 – AccESS Specifications

SPECIFICATIONS	AccESS I	AccESS II
General		
Dimensions (W x H x D)	28 x 72 x 16 in (w/feet) (71.2 x 183 x 40.7 cm)	28 x 72 x 16 in (w/feet) (71.2 x 183 x 40.7 cm)
Weight	10.5 kWh - 701.3 lb (318.10 kg)	7.0 kWh - 701.3 lb (318.10 kg)
Enclosure Rating	NEMA 3R Outdoor rated	NEMA 3R Outdoor rated
Operating Temperature	-4 to 122 °F (-20 to 50 °C)	-4 to 122 °F (-20 to 50 °C)
Mounting	Free-standing or pad-mounted	Free-standing or pad-mounted
Inverter		
Schneider Electric	Conext XW+ 6848 NA	Conext XW+ 6848 NA
Application	On / Off Grid	On / Off Grid
AC Connections	1 Grid Port, 1 Generator Port	1 Grid Port, 1 Generator Port
AC Output	30 A, 120/240 V AC, 60 Hz	30 A, 120/240 V AC, 60 Hz
Rated / Peak Power	6.8 / 8.5 kW (10.5 kWh Model)	5.5 / 7 kW (7.0 kWh Model)
Max Charge Rate	60 A AC, 7.2 kW	60 A AC, 7.2 kW
CEC Weighted Efficiency	92.50%	92.50%
Battery		
SimpliPhi Power	PHI 3.5 kWh 48VDC 60 Amp (x3)	PHI 3.5 kWh 48VDC 60 Amp (x2)
UL Rating	ETL Certified UL 1973 Standard	ETL Certified UL 1973 Standard
Rated kWh Capacity @ C/2	10.5 kWh	7.0 kWh
Depth of Discharge ^{1,2}	up to 100%	up to 100%
Round Trip Efficiency	98%	98%
Cycle Life	10,000+ (@ 80% DOD)	10,000+ (@ 80% DOD)
Warranty Period	10 years	10 years
Solar (select models)		
Schneider Electric Charge Controller ³	Conext MPPT 80 600	Conext MPPT 80 600
Output Power, Max	4.8 kW	4.8 kW
Charge Current, Max	80 A DC	68 A DC
PV Array Voltage, Operating	195 to 550 V DC	195 to 550 V DC
PV Array Voltage, Max Open Circuit	600 V DC	600 V DC
Options		
Schneider Electric	Conext AGS	Conext AGS
Wireless Gateway	Conext ComBox	Conext ComBox

Note: The AccESS does not need to be de-rated unless running continuously at more than 90% capacity, at temperatures below 0 degrees Celsius, or above 50 degrees Celsius.

2.3 – Inside the AccESS NEMA-3R Rated Cabinet

The AccESS system is enclosed within a NEMA-3R rated cabinet. Within, the internal layout provides easy access to clearly labeled wiring points and includes the necessary overcurrent devices, breakers and disconnects. See Figures 2.0 & 3.0 below for detail.

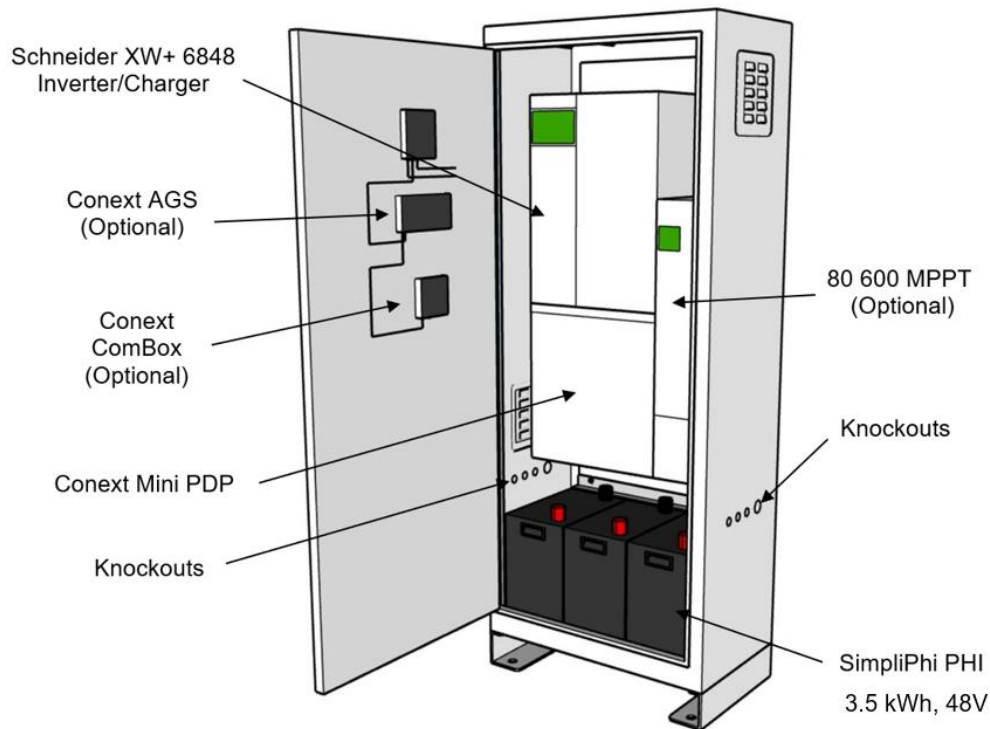

Figure 2.0 – AccESS Unit Components

The heart of the AccESS is the SimpliPhi Power PHI 3.5 kWh 48V 69Ah power storage modules. The power storage is modular and expandable. The base level energy storage is 7.0 kWh at 100 percent state of charge. This is provided by two PHI 3.5 kWh 48V 69Ah modules – combined in parallel.

Energy storage within the AccESS enclosure can be expanded to 10.5 kWh with the addition of a third PHI 3.5 kWh 48V 69Ah battery module. The power storage is paired with industry leading battery inversion and charging technology by Schneider Electric, capable of serving useful household loads. Additional storage capacity can be achieved by adding another AccESS Energy Storage Cabinet in parallel, side by side, with up to 12 of the PHI 3.5 kWh 48V batteries.

Available accessories allow for a DC connected PV system up to 4.8 kW, remote system monitoring, automatic generator start and cellular uplink for wireless, long range monitoring.

2.3.1 – AccESS Core Components

The core components within the AccESS unit include the below listed products. See Figures 2.0 & 3.0 for detail.

- Schneider Electric Conext XW+ 6848 NA
 - 6.8 kW Continuous Output 120/240 V AC
 - 12 kW AC Peak Output – 30 Seconds
- Conext Mini PDP
- (2) or (3) PHI 3.5 kWh Batteries (7.0 or 10.5 kWh)

2.3.2 – AccESS Optional Accessories

- **Schneider Electric Conext MPPT 80 600 (for DC Coupling)**

The Conext™ MPPT 80 600 solar charge controller offers an industry-first set of integration features and top performance that allows for large PV array systems to be easily installed and connected to the PHI 3.5 Battery bank at the lowest overall cost. Installing one MPPT 80 600 is faster than installing multiple smaller charge controllers and lowers overall costs further by utilizing fewer PV strings, smaller wiring and conduit, and by eliminating the need for PV combiner boxes and DC circuit breakers.

- **Schneider Electric Conext Battery Monitor**

Conext™ Battery Monitor indicates hours of battery-based runtime and determines battery bank state of charge. Conext Battery Monitor shares key battery bank parameters with Conext XW+ inverter/chargers.

- **Schneider Electric Conext Combox**

The Conext™ ComBox is a powerful communications and monitoring device for installers and operators of Conext solar systems. It features an integrated web server, enabling graphic displays of system daily, monthly and lifetime energy data to be viewed using a simple web browser or Android™ tablet device. Installers can change or configure the settings of Conext devices through the user-interface on the ComBox and respond to system email alerts promptly. A user-configurable data logger and integrated FTP server provides the system owner with powerful analytics tools for data download and analysis. Modbus™ interface on the ComBox links Conext devices with third party systems through RS-485 or Ethernet ports. For large multi-cluster systems, the ComBox can be setup in a master-slave configuration. Conext ComBox easily connects with Conext Insight to enable you to remotely monitor a portfolio of sites from any internet connected device like a laptop or a tablet.

- **Schneider Electric Conext Automatic Generator Start**

The Conext™ Automatic Generator Start (AGS) can automatically activate or stop a generator in response to changing power requirements. An excellent addition to an off-grid or backup power system, the AGS seamlessly connects to the Xanbus™ network and shares status information with all other devices on the network. It can monitor a set of system user-programmable parameters such as battery voltage, state of charge or grid power and can activate the generator in response to any changes. The AGS can also be configured remotely using the Conext System Control Panel (SCP) or Conext ComBox to engage a generator, and can assist an inverter/charger when output power demands are high.

- **Cellular Modem**

Allows remote monitoring of the system without utilizing a land-based internet connection.

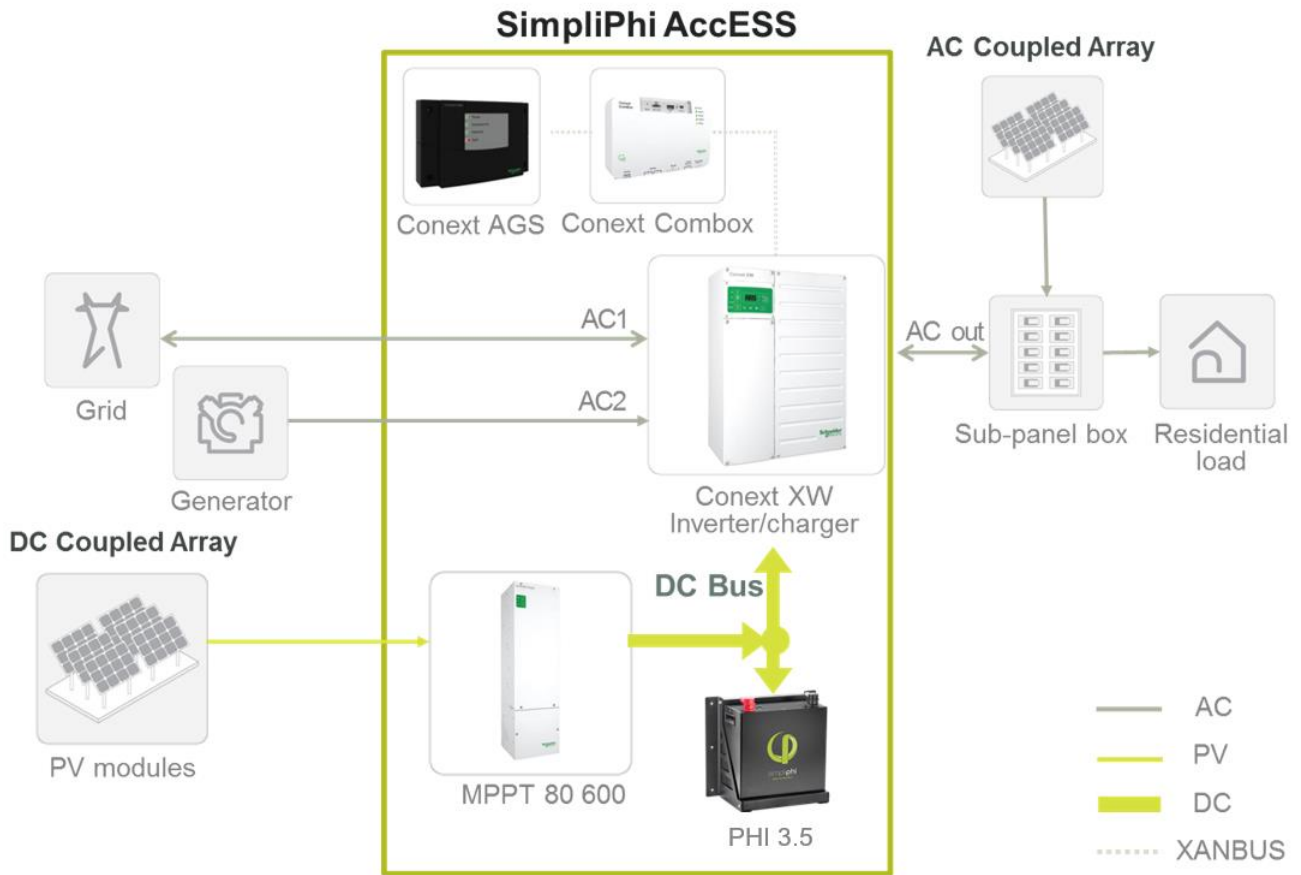

Figure 3.0 – ACCESS Unit Connections

3.0 – Pre-Installation

The information within this section covers pre-installation procedures & considerations, namely, PHI 3.5 Battery performance parameters to be aware of during the design process, guidance on system sizing, as well as installation site requirements and pad mounting.

3.1 – PHI 3.5 Battery Performance Parameters and Sizing Calculations

The PHI 3.5 Batteries within the AccESS (both AccESS I and AccESS II) are designed to operate at a continuous C/2 rate across a large operating temperature range, as seen in Table 1.0 above. The SimpliPhi AccESS needs no increase in sizing and no special compensations when determining the size of the energy storage and management system under the circumstances and conditions seen in Table 1.0 above. Each AccESS unit comes pre-programmed to maximize the performance of the PHI 3.5 Battery bank.

PHI 3.5 Batteries within the AccESS unit do not need to be de-rated unless running continuously at more than 90% capacity, at temperatures below 0° C, or above 49° C. To achieve higher, warranted cycles of 10,000+, the PHI 3.5 Batteries are typically operated at 80% maximum Depth of Discharge. The AccESS comes pre-programmed for 80% depth of discharge. Please contact SimpliPhi Power Technical Support if alternative settings are desired. Please also refer to operating temperatures and inverter settings in Programming section.

3.1.1 – Design Parameters: Maximum Sizing Guidelines

Below are the maximum sizing guidelines for installations of the AccESS:

- Maximum AC input / output OCPD = 60 A
- Maximum DC coupled PV array = 4.8 kW DC
- Maximum AC coupled PV array: lesser of 48 A operating current or 13.6 kW AC
- Maximum AccESS units combined in parallel: 3 Units = 20.4 kW AC

3.2 – System Sizing for Your Installation

The number of PHI 3.5 Batteries within the AccESS unit should be specified in terms of total storage capacity before the initial installation based on the goals and objectives of the project. All PHI 3.5 Batteries are balanced during final production and testing stages. Following proper wiring guidelines ensures that a system will not require any manual balancing processes.



CAUTION: Do not combine PHI 3.5 Batteries with other brands or chemistries. This will void the Warranty.



CAUTION: Do not mix PHI 3.5 Batteries from different installations, clients or job sites. This will void the Warranty.

3.3 – Installation Tools and Materials

- Digital Multi Meter
- AC/DC Clamp On Current Meter
- Wire Stripper
- Impact Driver
- Masonry Bolts

3.4 – Installation Site Location

The AccESS may be installed indoors, such as a garage, or outdoors mounted onto a concrete pad. The cabinet is rated for NEMA-3R use. Please see Figure 4.0 below for physical AccESS dimensions, as this may impact the site location.

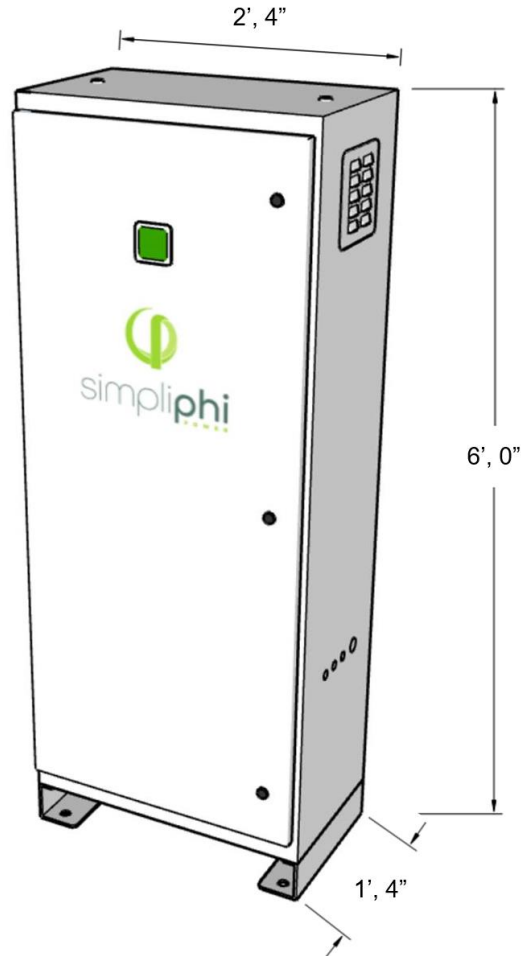

Figure 4.0 – AccESS Unit Dimensions

3.5 – Clearance Requirements

The AccESS should be installed with 3 inch (7.62 cm) clearance to the sides and 3 feet (0.91 m) clearance to the front. Please see Figure 5.0 for details. All installations should comply with local code requirements and/or the local AHJ, which may exceed the requirements shown.

Note: If installing multiple AccESS units to be connected together, no clearance is required between units. Enclosures may be placed directly adjacent to each other.

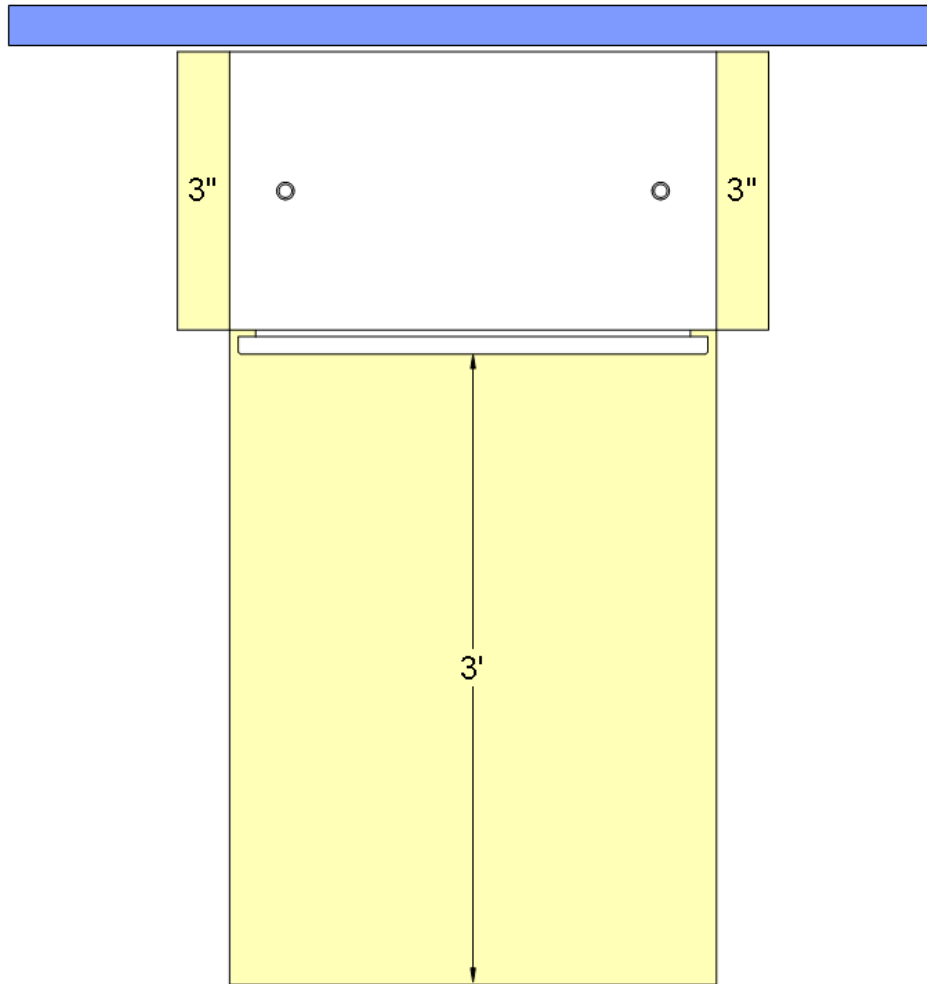

Figure 5.0 – AccESS Unit Clearances

3.6 – Knock Out Locations

Three 1-inch OD knockouts and one 1.5-inch OD knockout are located on both sides of the AccESS cabinet. They can be used for AC or DC inputs. Not all knockouts may be used.

3.7 – Pad Mounting

3.7.1 – Pad Requirements

The AccESS must be installed and secured on level concrete. For a pre-cast concrete pad, a 4" minimum thickness is required. The pad should be 3" wider than the AccESS on all sides (34" x 22" x 4").

The AccESS is not suited for wall mounting. Any attempt to wall mount the AccESS unit will void the Warranty.

3.7.2 – Pad Mounting the SimpliPhi AccESS

Six 1-inch knockouts are located in the base of the AccESS for tool accessibility when mounting the AccESS to the concrete pad. Cover knockout holes with sealing tape after pad mount installation, and prior to installing the PHI 3.5 Batteries into the base of the cabinet. Any attempt to wall mount the AccESS unit will void the Warranty.

Secure the AccESS to the concrete with concrete anchors, such as threaded rods, masonry bolts, or carriage bolts, minimum ½” diameter. See Figure 6.0 below for details.

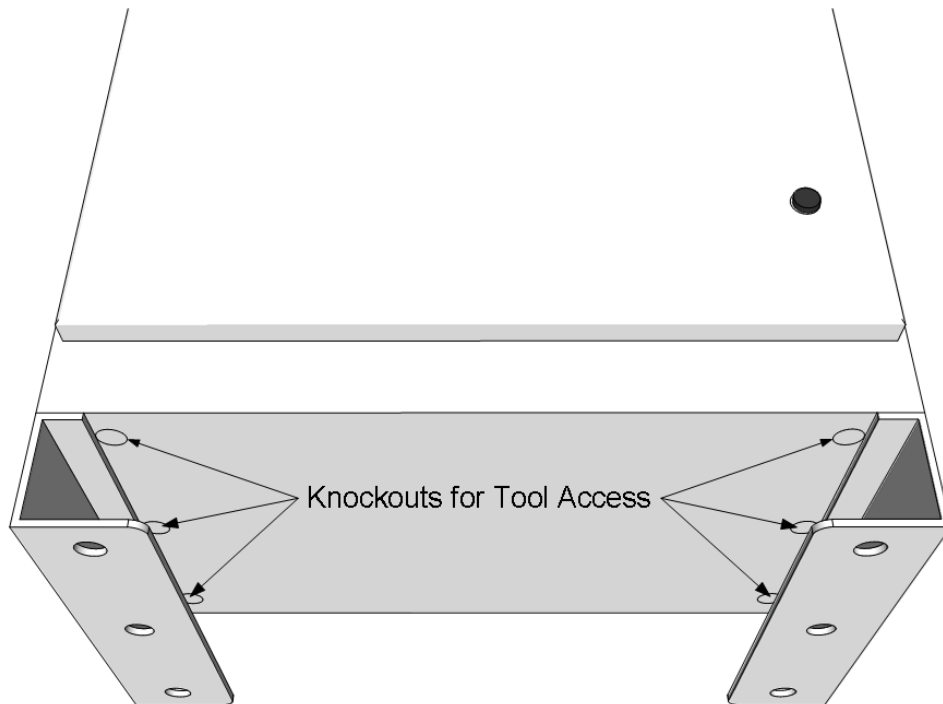

Figure 6.0 – AccESS Unit Knockouts (Bottom)

4.0 – Installation & Wiring

This section covers how to install the PHI 3.5 Batteries within the AccESS unit, torque values, communications and network preparation and how to wire the AccESS unit. It also provides guidance on how to install optional AccESS unit components/accessories.

4.1 – Basic System Configuration Concepts

Safe and reliable installation requires trained and certified technicians. The following discussion is a basic primer. Due to the variety of systems and components in the field, all possible scenarios are not covered. This is not the purpose of this section of the manual. Refer to professional installers regarding your system and its components and specifications. We encourage you or your installer to contact us with any specific questions for technical support. We are committed to working with you and your installation team to achieve a safe, reliable storage system that will provide years of maintenance free service.

4.2 – PHI 3.5 Battery Installation within the AccESS

4.2.1 – Battery Bank Properties

The SimpliPhi AccESS utilizes SimpliPhi's PHI 3.5 kWh 48V Batteries with Lithium Ferrous Phosphate (LFP) cells. SimpliPhi's LFP cells are produced under exclusive patented licensed technologies, as well as proprietary materials, architecture, assembly methods and battery management system (BMS). This assures the highest grade and quality, longest cycle-life, greatest efficiency and freedom from material impurities, toxicity and hazardous risk. They do not contain cobalt.

Each PHI 3.5 Battery contains circuitry that protects the Lithium Ferrous Phosphate cells from overcharge, over-discharge and excessive load amperage. If the values specified are exceeded, the protective circuitry will shut down the flow of electricity to/from the PHI 3.5 Batteries. In some cases, this will result in the need to re-initialize an inverter charger. Each AccESS unit is programmed to avoid such a situation, barring abnormal conditions beyond the designed parameters and Warranty terms. If low voltage incidents do occur, the inverter settings will be saved within the inverter memory storage and will not need to be reset.

4.2.2 – Battery Bank Installation

After mounting the AccESS unit on concrete, place either 2 or 3 PHI 3.5 Batteries in the bottom of the cabinet. Connect the Polar Cable that is pre-wired into the Mini PDP to the positive and negative terminals of each PHI 3.5 Battery per the torque values in the next section. Leave the PHI 3.5 Batteries in the "OFF" position until the basic functional test.



CAUTION: PHI 3.5 Batteries must be fully charged before commissioning the AccESS unit. Failure to do so will void the Warranty.



CAUTION: Verify polarity at all connections before energizing system. Reverse polarity at the PHI 3.5 Battery terminals will void the Warranty and destroy the PHI 3.5 Batteries.



CAUTION:

Solid **Blue** Wire = Negative Lead
Blue with **Red** Stripe = Positive Lead

4.3 – Torque Values

For the DC terminals on the PHI 3.5, torque bolts to 160 in-lbs (13.3 ft-lb). For the Mini PDP, torque to the specified in-lbs listed below.

Table 2.0 – Mini PDP Torque Values

AWG	in-lbs	N-m
14 - 10	35	4.0
8	40	4.5
6 - 4	45	5.1
3 – 2/0	50	5.6

4.4 – Communications and Network Preparation

Communication and Monitoring is available via the Optional Schneider Electric Conext ComBox and the internet services available at the installation site.

A cellular Modem can be used to add range for far remote data monitoring.

ComBox Configuration will enable:

- Viewing of all Xanbus Connected Devices: AGS, SCP, XW, MPPT
- Receipt of Email Energy Reports
- Receipt of Email Device Alerts
- Remote Monitoring, Control and Configuration VIA Modbus
- View Status and Updates VIA Android Tablet Interface

For ComBox configuration, please see the provided ComBox documentation or download the latest updates from Schneider Electric's website.

4.5 – Wiring the AccESS

4.5.1 – Wiring Diagrams

Please reference the below listed DC coupling and AC coupling diagrams, where applicable.

DC Coupled System:

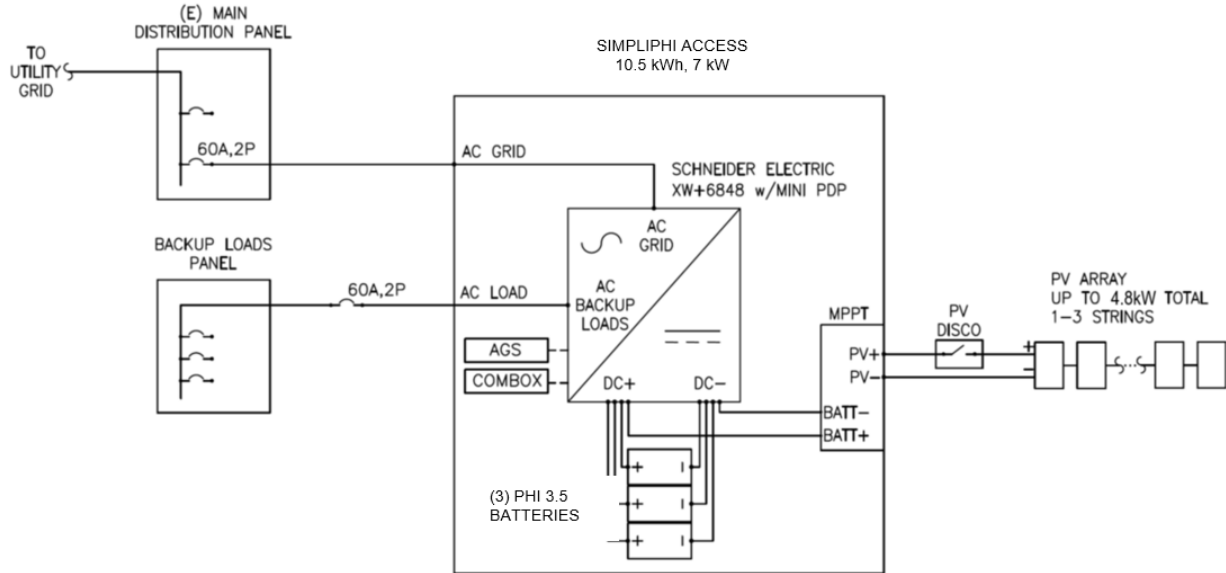

① WIRING DIAGRAM - DC COUPLED
N.T.S.

AC Coupled System:

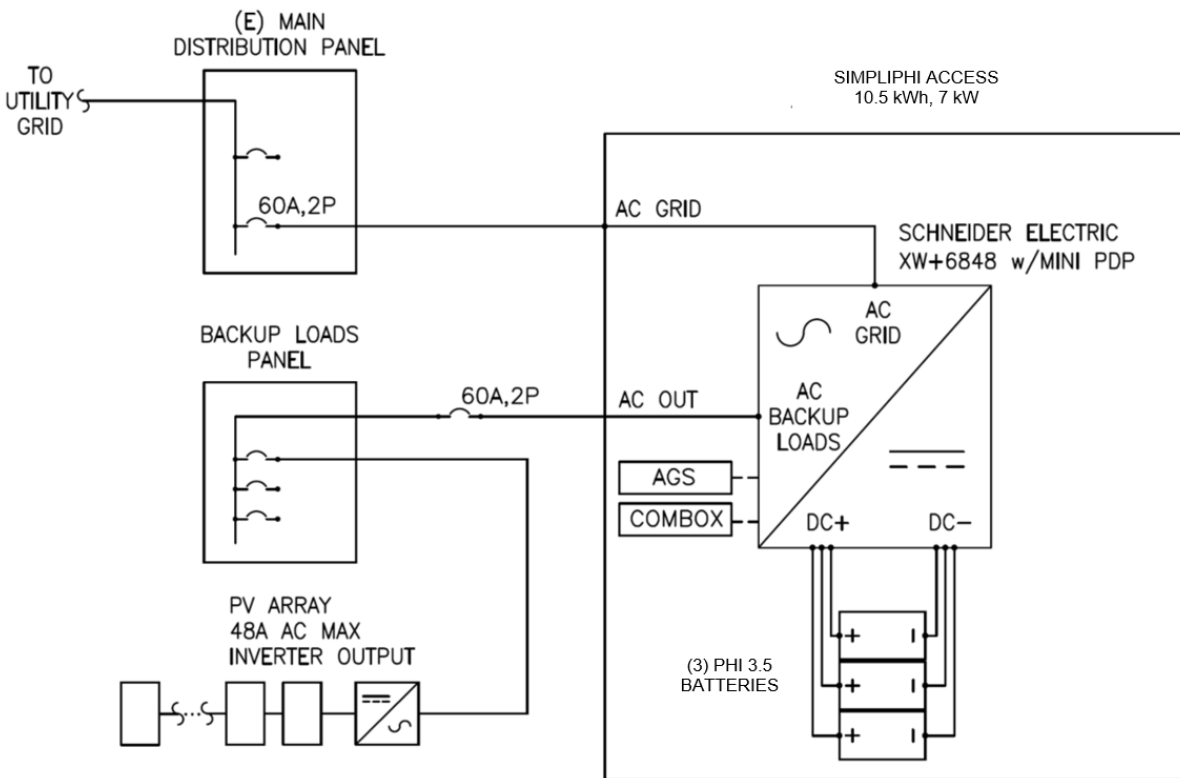

2 WIRING DIAGRAM - AC COUPLED
N.T.S.

4.5.2 – Making AC Connections

AC Landing Points – Terminal Blocks

The SimpliPhi Access is equipped with multiple knockouts on either side of the Access for accessibility to the AC connections. All AC connections are at 240 V. Please refer to Schneider Electric's Conext XW+ Installation Manual for 120 V installations.

The Mini PDP has landing points for:

- AC IN: grid input
- AC OUT: home subpanel, optional AC coupled PV

Figure 7.0 below indicates the locations where AC IN and AC OUT wiring will be connected. Also highlighted are the neutral and ground AC terminal blocks.

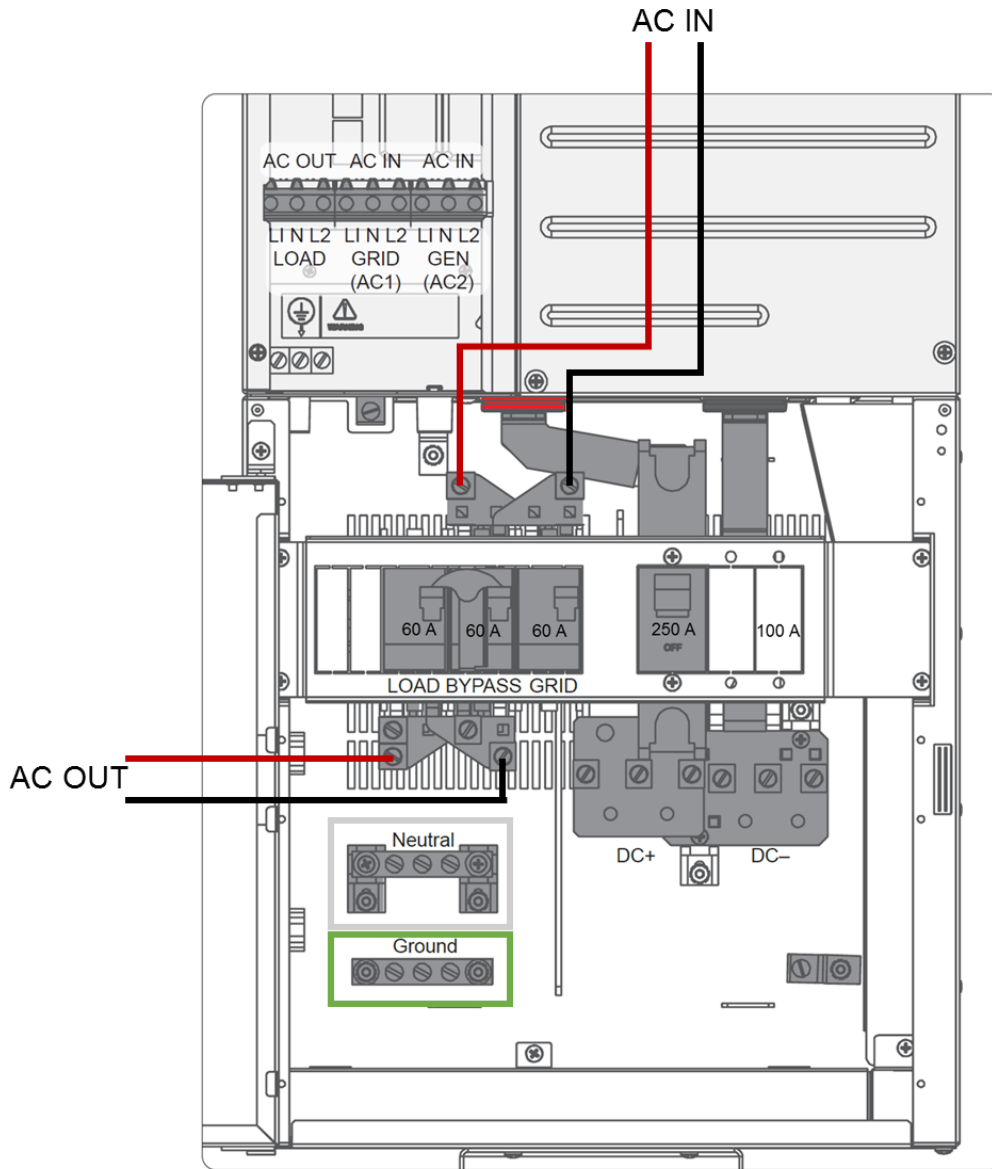

Figure 7.0 - AC Power Input/Output Wiring Connection Points

Generator AC Wiring

For connecting a generator with the optional AGS from Schneider Electric, please refer to Schneider Electric's AGS Installation Manual.



CAUTION: On the Conext Mini PDP, an additional circuit breaker will need to be installed. The Generator will connect through this circuit breaker and to the XW+ 6848 inverter.

1 Install a fourth AC breaker (not provided) in the highlighted slot.

2 Connect L1 and L2 wire ends to the AC2 terminals (GEN) (as shown).

(1st pair)

3 Connect L1 and L2 wire ends to the breaker output terminals (as shown).

4 Connect L1 and L2 wire ends to the breaker input terminals.

(2nd pair)

5 Connect L1 and L2 wire ends to the generator's AC OUT terminals.
GENERATOR CONNECTION ONLY

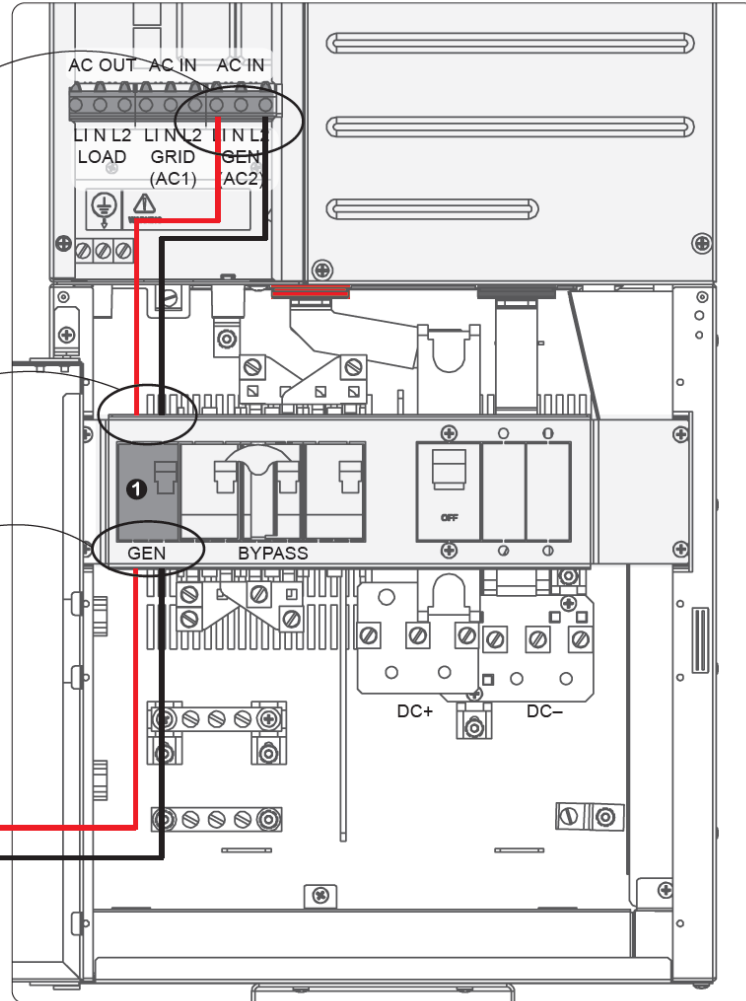

Figure 8.0 – Optional Generator Installation/Connection Diagram

Inverter Charger Grounding

The Conext XW+ is provided with ground terminals that must be reliably connected to ground (protective earth) by appropriately sized equipment grounding conductors. System grounding for the AC and DC systems must be done according to all applicable NEC and local installation codes.

Feed-in Protection Requirements

The amount of power that can be fed into a distribution panel and the means and location for feed-in, must be in accordance with NEC 2017 article 690.64 or the current requirements of the local electrical code.

Failure to follow these instructions can result in damage to equipment and void the Warranty.

4.5.3 – AC System Bonding

Multiple AC Neutral-to-Ground Bonds

Verify that only **one** neutral-to-ground bond exists in the system. Having more than one neutral-to-ground bond in a system violates local electrical codes, may create a shock or fire hazard, and may cause some sensitive equipment to malfunction.

Failure to follow these instructions can result in death or serious injury and will void the Warranty.

System bonding refers to connection (bonding) of one of the current-carrying conductors of an electrical system to ground. This creates a "grounded conductor" or "neutral" that is at ground potential, but is separate from the equipment ground conductor. System bonding must be done at only one location. Procedures for system bonding vary between on-grid and off-grid systems.

System bonding for on-grid systems

The Conext XW+ does not connect the neutral to ground. The AC input neutral is already bonded to ground by the incoming utility grid system. Do not connect the neutral to ground in any additional location.

The Conext XW+ does not switch or disconnect the AC neutral in any mode of operation, so even in invert (back-up) mode, the inverter load sub-panel neutral is bonded to ground by the utility grid system. It must not be grounded again in the inverter load sub-panel.

System bonding for off-grid systems

In a system without a generator, or with a generator that does not provide a grounded neutral, you must make the connection from neutral to ground in the inverter load sub-panel or main distribution panel, as applicable.

In a system with a generator that provides a grounded neutral, no additional connection from neutral to ground is needed. Do not connect neutral to ground in the inverter load sub-panel or main distribution panel, as applicable.

For more information regarding installations with a generator, please refer to Schneider Electric's manual for the AGS.

4.5.4 – Making DC Connections

This section only applies to AccESS systems equipped with the optional Conext MPPT 80 600 Solar Charge Controller. Refer to the Conext MPPT 80 600 Owner's Guide for further information regarding functionality programming of the charge controller.

Note: Before connecting PV, verify the cable polarity and mark the cable accordingly as Positive or Negative.

The SimpliPhi AccESS is equipped with multiple knock outs.

- Bring the PV wiring from the PV disconnect into the AccESS enclosure through the appropriate knock out for PV IN.
- Strip 0.5" of insulation from the Positive PV Conductor(s). (1.27 cm).
- Insert the stripped conductor end into the terminal of the MPPT.
- Repeat for the Negative PV Conductor(s)

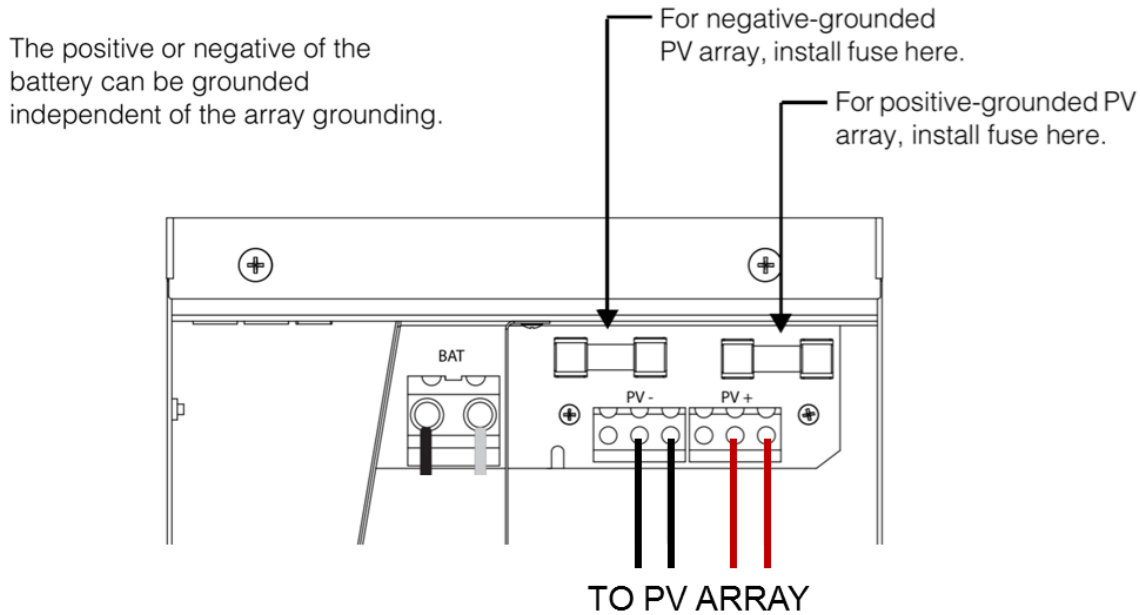

Figure 9.0 – PV Array Connection Points

AccESS DC Grounding

To connect the Conext XW+ to the DC grounding system, use the ground lug at the bottom of the Conext XW+ chassis. The terminal accepts wires from #14 AWG (1.63 mm) to #2 AWG (6.54 mm).

System grounding for the DC system, which typically involves bonding (connecting) the PHI 3.5 Battery negative circuit to ground, is dependent on the system configuration.

Note: if a grounded DC system is required, ensure that the system bonding is done in one location only, and that all conductors and connections comply with all applicable NEC and local installation codes.

4.5.5 – Basic Functional Test

The following procedure should be followed once the installation is complete and before it is put into service.

Step 1: Confirm All Connections

After the AC and DC wiring has been installed and connected, check that all connections are correct and secure.

Step 2: Apply DC Power to the Inverter

1. Before applying DC power to the inverter, measure the voltage and check polarity at all connections (Measure at the PHI 3.5 Battery side of the disconnect or breaker.)
2. Apply PHI 3.5 Battery (DC) power to the inverter by closing the PHI 3.5 Battery bank DC disconnect. The inverter will power up in standby mode, and the inverter information panel will display Stb (standby), as shown below.

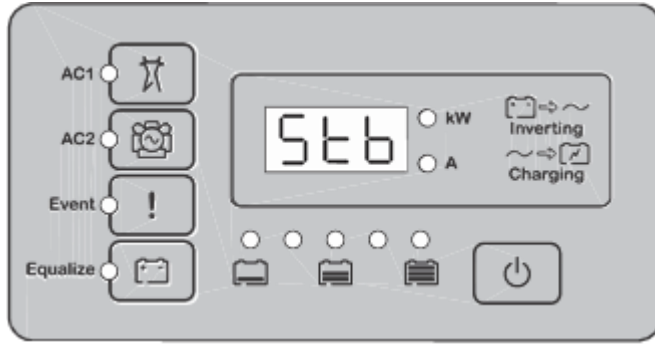

Figure 10.0 – Inverter Power-Up Standby Display

Step 3: Enable the Inverter

Invert mode is enabled by default, and the Conext XW+ should begin inverting upon transitioning from standby mode. If invert mode is disabled, the inverter information panel will display " - - - " once out of standby mode, as shown below. If the Conext XW+ powers up in standby mode, press the STARTUP/ SHUTDOWN button momentarily to change the mode from standby to operating.

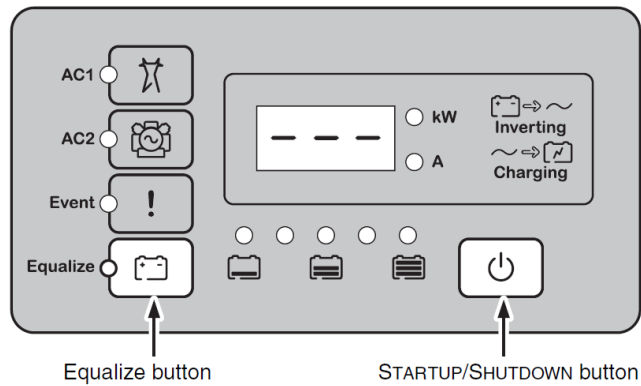

Figure 11.0 – Inverter Disabled Display

To enable the inverter:

On the inverter information panel, simultaneously press the STARTUP/ SHUTDOWN button and the Equalize button. The Conext XW+ is now enabled, and "En" (enabled) is briefly displayed on the inverter information panel

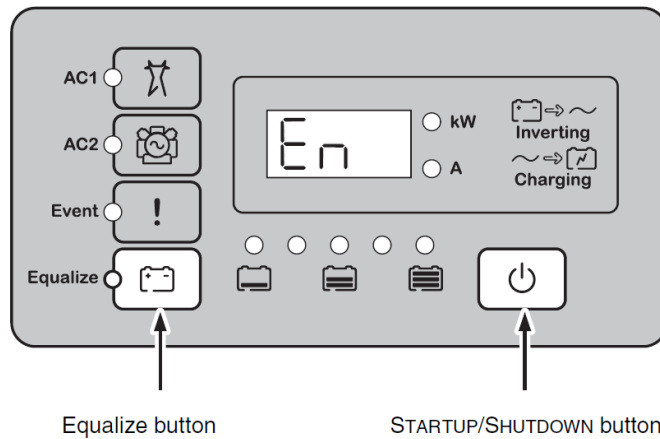

Figure 12.0 – Inverter Enabled Display

To disable the inverter:

On the inverter information panel, simultaneously press the STARTUP/ SHUTDOWN button and the Equalize button. The Conext XW+ is now disabled, and “diS” (disabled) is briefly displayed on the inverter information panel, followed by “- - -”.

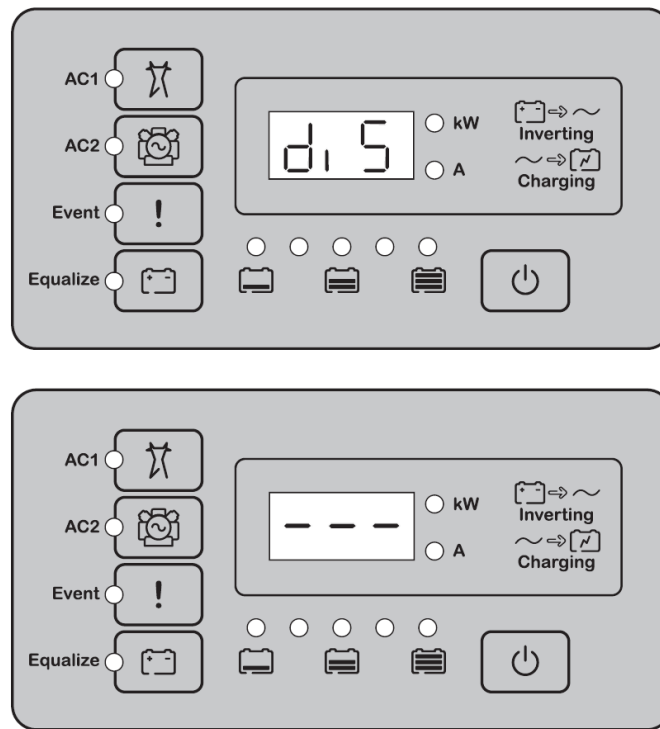

Figure 13.0 – Inverter Disabled Display

Monitor the invert (green kW) LED to confirm which mode the inverter is in:

- kW LED OFF – Invert mode is disabled. The inverter/charger is not powering the AC loads. However, if good AC is present, it is passed through to the loads.
- “Sch” displayed on the inverter information panel – The inverter/charger is in search mode and is looking for an AC load greater than the Search Watts setting (default = 25 watts). The display shows “Sch” (Search) when this mode has been enabled.

- kW LED ON – The inverter/charger is on. The inverter is operating and is able to provide power to the AC loads. This is the default mode on initial power-up once the unit is taken out of standby mode.

If the inverter is not operating or the inverter LED (kW) does not turn on, check all connections. Check the inverter's DC voltage and polarity on the positive (+) and negative (-) terminals. Check the Fault LED. If the fault LED is on, check for a fault code on the information panel. Correct the reported fault and clear the fault by acknowledging it. If the DC voltage is low, then the PHI 3.5 Battery bank needs to be charged externally. Charge the PHI 3.5 Battery bank and restart the functional test.

AC Voltage Check

1. With the inverter on (green kW LED is on and steady), verify the AC voltage at AC Loads block terminal L1-Load to N-Load.
2. Verify that neutral is bonded to ground in the system by measuring the hot and neutral voltages relative to ground. Neutral-to-ground should equal zero (0) volts.
3. After confirming the correct AC voltage, turn on your AC output breaker and place a load on the inverter (plug in a light or other load to an outlet the inverter is powering).
4. Confirm that the AC load that was just turned on is working properly

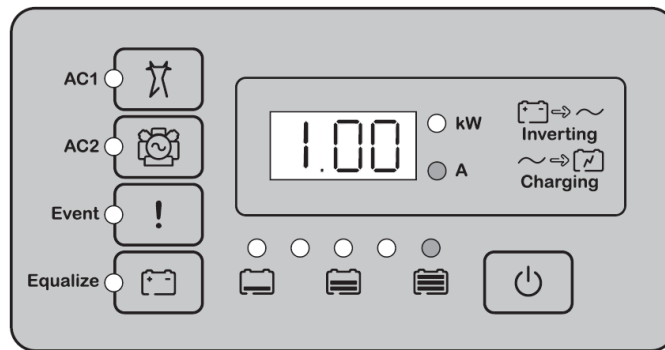

Figure 14.0 – Inverter AC Load Display

Confirming Battery Charger Operation

1. Apply AC from grid or generator. LEDs will blink while the power source is qualified.
2. Check LEDs (AC1 or AC2) on the front panel. One of them must be ON for the unit to charge.
3. Check the amp (A) LED. If the A LED is ON, the unit is charging and the PHI 3.5 Battery current is displayed on the inverter information panel.

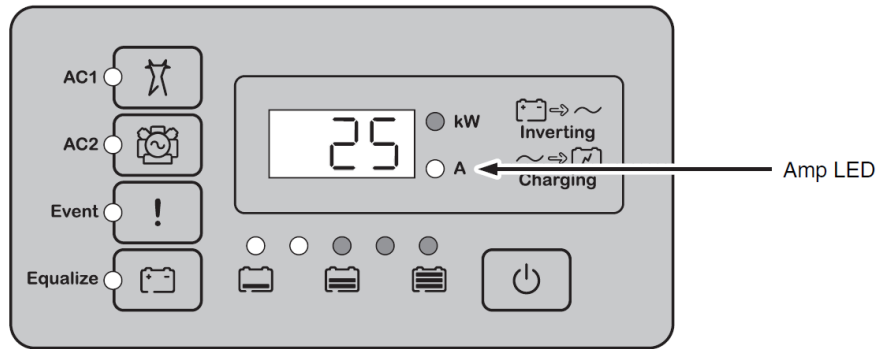

Figure 15.0 – Inverter Charge Rate Display

This completes the functional test. The internal set points have been pre-programmed for the PHI 3.5 Battery bank.

4.6 – AccESS Optional Components/Accessories Installation

4.6.1 – DC Coupled PV – 4.8 kW

The AccESS may be DC Coupled with a PV system up to 4.8 kW DC. Please refer to Schneider Electric’s MPPT 80 600 installation manual and wiring diagrams for further information.

4.6.2 – Remote System Monitoring

Schneider Electric Conext ComBox

If purchased with the Conext ComBox option, please refer to the Conext ComBox Owner’s Guide from Schneider Electric.

Network Requirements

Before making AC and DC connections, route communication cables (including Battery Temperature Sensor) through the raceways. For easier identification, use a different color for each communications cable, or cable tags.

Connect communications cables to their components after AC and DC connections are made.

4.6.3 – Automatic Generator Start

Schneider Electric Conext AGS

If purchased with the Conext Automatic Generator Start, please refer to the Conext Automatic Generator Start Owner’s Guide from Schneider Electric.

4.6.4 – Battery Monitoring

Schneider Electric Conext Battery Monitor

If purchased with the Conext ComBox, the Conext Battery Monitor is included on the exterior door. This comes pre-wired and configured, but for more information, see the Conext Battery Monitor Quick Start Guide.

5.0 – Programming

5.1 – Depth of Discharge

The AccESS comes pre-programmed for 80% depth of discharge (DoD). This qualifies for the 10-year / 10,000 cycle Warranty on the PHI 3.5 Batteries.

To change the DoD to the 5,000 cycle Warranty or 3,500 cycle Warranty, modify the voltages in the Basic Settings and Advanced Settings per the Programming section. Refer to the PHI 3.5 Battery Warranty.

If a firmware update is executed on the AccESS, please verify all PHI custom settings are still in place. These settings can be found at the end of this manual in Section 7.0: Operating Parameters.

5.2 – Configuring the Schneider Electric Conext XW+

The Schneider Electric Conext XW+ is capable of many different modes of operation via configurable settings. This includes:

- AC Input Settings
- Grid Support Settings
- Prioritizing and Managing Energy Sources
- Generator Support Settings
- Auxiliary Output Settings

These settings can be modified to support the function the owner would like to achieve with the AccESS unit. To configure the AccESS, please refer to Schneider Electric's Conext XW+ Inverter/Charger Owner's Guide.

The Schneider Electric Owner's Guide contains information and procedures necessary for configuring, operating, maintaining, and troubleshooting the Schneider Electric Conext XW+ Inverter/Charger. The guide is intended for anyone who needs to operate, configure, and troubleshoot the inverter. Certain configuration tasks should only be performed by qualified personnel.

5.3 – Operating Parameters Per Warranty

Although the PHI 3.5 Batteries within the AccESS unit are capable of performing at very high rates and depths of discharge within a very wide temperature range, in order to achieve extended life cycles and to comply with the Warranty, the operating parameters, indicated in Tables 3.0 and 4.0 below, must be adhered to. The parameters shown in Table 3.0 below must be applied based on desired Warranty/cycle life. The AccESS comes pre-programmed for 80% depth of discharge.

5.3.1 – Inverter Programming Settings

Schneider Electric Conext XW+ Inverter/Charger

The Schneider Electric Conext XW+ Inverter/Charger has a firmware limitation that creates a potential issue with Lithium-Ion batteries: the Low Battery Cut-Out Voltage (LBCO) setting is limited to 48V maximum. This value is below the recommended LBCO settings to maximize cycle-life of most Lithium-Ion batteries including PHI 3.5 Batteries. Per the Warranty, a 48V LBCO corresponds to 100% DoD and maintains a much more limited cycle life.

Until Schneider releases updated firmware to adjust this setting above 48V, this issue can be largely mitigated by setting the "Recharge Volts" above the desired LBCO thresholds as outlined Table 1.0 above. Therefore, systems that do not rely solely on renewable energy (i.e. grid tied systems, AGS systems) will typically start charging the PHI 3.5 Batteries once the recharge voltage level is reached, preventing further discharge of the PHI 3.5 Batteries and thus optimizing cycle-life.

**Table 3.0 – Programming Settings for SimpliPhi PHI 3.5 kWh 48V Battery
w/Schneider Electric Inverter XW6848-01 00**

INVERTER - XW6848-01 00	10K Cycles Warranty	5K Cycles Warranty	3.5K Cycles Warranty
Advanced Settings > Inverter Settings	80% DoD	90% DoD	100% DoD
Low Battery Cut-Out Voltage ¹	48V (50.2V Recommended)	48V (49.6V Recommended)	48V
LBCO Hysteresis	2.0V		
LBCO Delay	10 Sec		
High Batt Cut Out	60V		
Search Watts	Default		
Search Delay	Default		
Charger Settings > Custom Settings			
Batt Type	Lithium Ion		
Lithium Ion			
Control	2StgNoFloat		
Bulk Voltage	55.4V	57.2V	57.2V
MaxBulkCurrent (C/2) ²	34A per PHI3.5; (68A for 2, 102A for 3)		
DisChglmax ²	60A per PHI3.5; (120A for 2, 180A for 3)		
DisChglmax Timer	10 Minutes		
Batt Capacity ²	69Ah per PHI3.5; (138Ah for 2, 207Ah for 3)		
Max Charge Rate (C/2) ²	34A per PHI3.5; (68A for 2, 102A for 3)		
Default Batt Temp	Warm		
Recharge Volts	50.5V		
Absorb Time	6 Minutes		
Chg Block Start	Default		
Chg Block Stop	Default		

5.3.2 – MPPT Programming Settings

Table 4.0 – Programming Settings for SimpliPhi PHI 3.5 kWh 48V Battery
w/Schneider Electric XW MPPT80

XW MPPT80	10K Cycles Warranty	5K Cycles Warranty	3.5K Cycles Warranty
Advanced Settings > Charger Settings	80% DoD	90% DoD	100% DoD
Batt Type	Custom		
Custom Settings			
Eqlz Supt	Disabled		
Bulk Voltage	56V	57.6V	57.6V
Absorb Voltage	56V	57.6V	57.6V
Float Voltage	54V		
Batt Temp Comp	0mV/C		
Batt Capacity ²	69Ah per PHI3.5; (138Ah for 2, 207Ah for 3)		
Max Charge Rate (C/2) ²	34A per PHI3.5; (83% ~68A for 2, 100% 80A for 3)		
Charge Cycle	3 Stage		
ReCharge Volts	50.5V		
Absorb Time	6 Minutes		
Default Batt Temp	Warm		
Batt Voltage (Auto-detected)	48V		
Aux Settings	Not Used		
...	Default		

5.3.3 – Battery Monitor

Table 5.0 – Programming Settings for SimpliPhi PHI 3.5 kWh 48V Battery
w/Schneider Electric Conext Battery Monitor

Conext Battery Monitor	10K Cycles Warranty	5K Cycles Warranty	3.5K Cycles Warranty
Advanced Settings	80% DoD	90% DoD	100% DoD
Capacity ²	69Ah per PHI 3.5		
Discharge Rate	20 Hrs		
Nominal Temp	67F		
Shunt Amps	500		
Shunt mV	50		
Self Disch	<1%/Month		
Discharge Floor	20%		
Float Voltage	53.32		
Float Amps	2%		
Auto Sync Time	240 Sec		
Temp Unit	Celsius		
Back Light Timer	30 Sec		
Peukert Expo	1.05		
Charge Eff Mode	Automatic		
Temp Coeff	0.5Ah/degC		
Default Temp	76 Deg F		
Sync Sensitivity	5		
Time Rem Filter	Faster		

Notes:

1. Maximum setting of 48V limited by some inverter firmware is below the recommended setting.
2. Per PHI 3.5 Battery – These setting are calculated by multiplying the nominal per battery value times the # of batteries.
 - Levels are typical @ 25C and may need adjusting at temperature extremes.
 - When performing rapid deep charge/discharge cycles the battery should be allowed to "rest" 15 minutes in between.

5.3.4 – PHI 3.5 Voltage Reference of Battery State of Charge

Figure 16.0 and Table 5.0 below depict the typical voltage levels (VDC) for the PHI 3.5 Battery at various states of charge.

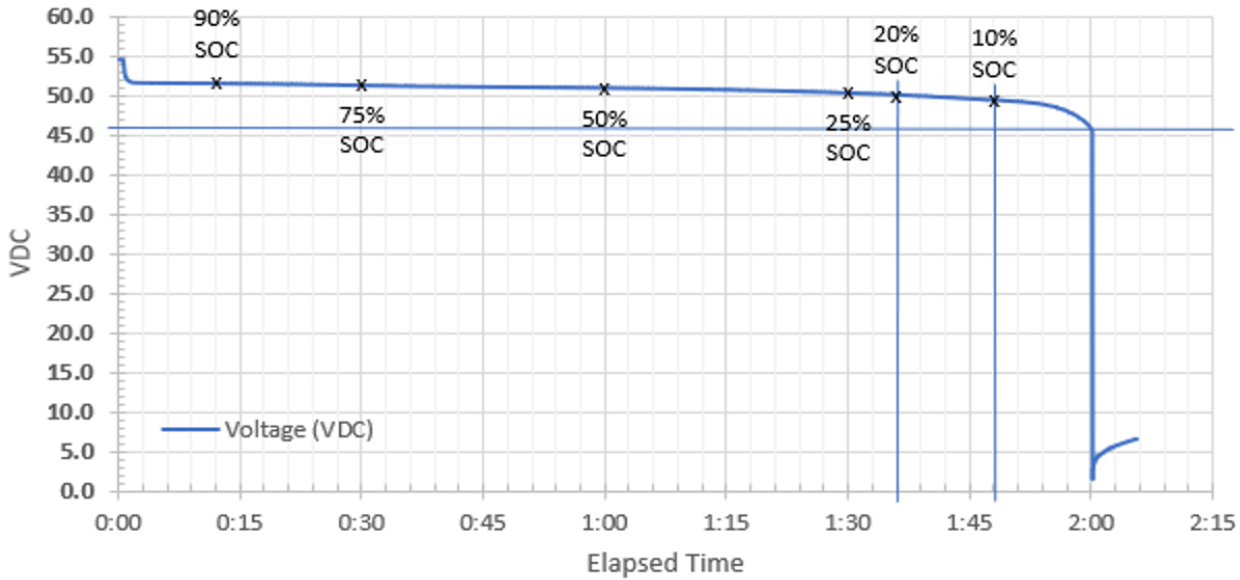

Figure 16.0 – PHI 3.5 C/2 Discharge Curve (typical)

Table 5.0

SOC	Voltage*
100%	> 52.50 V
95%	51.70 V
90%	51.65 V
75%	51.40 V
50%	51.00 V
20%	50.20 V
10%	49.50 V
0%	46.00-48.00 V

*Levels typical @ C/2

6.0 – SimpliPhi Technical Support

For technical support related to your AccESS, please contact us as follows:

805.640.1874

techsupport@simpliphipower.com

Appendix A – Schneider Electric Product Specifications

A.1 – Electrical Specifications for Schneider Electric Conext XW+ 6848 NA

Continuous Output Power	6,800 W
Surge Rating (Overload for 1 minute)	12,000 W
Surge Rating (Overload for 5 minutes)	11,000 W
Surge Rating (Overload for 30 minutes)	8,500 W
Surge Current	L-N: 104 A _{rms} (60 s) L-L: 52 A _{rms} (60 s)
Waveform	True Sine Wave
Idle Consumption—Inverter mode, no load	28 W
Idle Consumption—Search mode	< 8 W
AC Output Voltage	L-N: 120 VAC ±3% L-L: 240 VAC ±3%
AC Input Voltage range (Bypass/Charger Mode)	L-N: 78–140 VAC (120 V nominal) L-L: 160–270 VAC (240 V nominal)
AC Input Breaker	60 A double-pole
AC Input Frequency Range (Bypass/Charger Mode)	52–68 Hz (default)
AC Output Current (maximum 75% imbalance between L1-N, L2-N) in Inverter Mode	L-N: 48 A L-L: 28 A
AC Output Breaker	60 A double-pole
AC Output Frequency	60.0 ±0.1 Hz
Total Harmonic Distortion	< 5% at rated power
Automatic Transfer Relay	60 A
Auxiliary Relay Output	0–12 VDC, maximum 250 mA DC
Peak Efficiency	95.7%
CEC Weighted Efficiency	92.5%
CEC Power Rating	6,000 Wa 5,760 Wb
DC Input Voltage (Nominal)	48 VDC
DC Input Voltage Range	40–64 VDC

DC Current at Rated Continuous Power (Inverter Mode)	180 A
Continuous Charge Rate at L-L voltage (Charger Mode)	140 A
Power Factor Corrected Charging	PF (0.98)
Typical Transfer Time	8 ms

A.2 – Schneider Electric Conext XW+ Grid Tie Specifications

Function	120 V/240 V	120 V	Response Time
Anti-islanding reconnect	254.4 V (± 3 V)	127.2 V (± 3 V)	300 s (+1/-0 s)
Over frequency disconnect	60.5 Hz (± 0.05 Hz)	60.5 Hz (± 0.05 Hz)	60 ms (± 20 ms)
Under frequency disconnect	59.3 Hz (± 0.05 Hz)	59.3 V (± 0.05 Hz)	60 ms (± 20 ms)
Over voltage LN fast disconnect	135 V (± 1.5 V)	135 V (± 1.5 V)	60 ms (± 25 ms)
Over voltage LN slow disconnect	132 V (± 1.5 V)	132 V (± 1.5 V)	500 ms (± 50 ms)
Over voltage L1/L2 fast disconnect	270 V (± 3 V)	–	60 ms (± 25 ms)
Over voltage L1/L2 slow disconnect	264 V (± 3 V)	–	500 ms (± 50 ms)
Under voltage LN fast disconnect	67 V (± 5 V)	75 V (± 5 V)	60 ms (± 25 ms)
Under voltage LN slow disconnect	105.6 V (± 1.5 V)	105.6 V (± 1.5 V)	1000 ms (± 40 ms)
Under voltage L1/L2 slow disconnect	211.2 V (± 3 V)	–	100 ms (± 40 ms)
Under voltage L1/L2 fast disconnect	150 V (± 10 V)	–	60 ms (± 25 ms)

A.3 – Schneider Electric Conext XW+ Series Inverter/Charger Overload Capability

Loads connected to the inverter are seldom constant, and large loads are often operated for short periods. To accommodate larger loads, the Conext XW+ can temporarily exceed its continuous output power rating.

The graphs below illustrate approximate operation time versus load. Inverter operation time during overload is limited by both inverter internal temperature protection and by the product of AC output current and elapsed time.

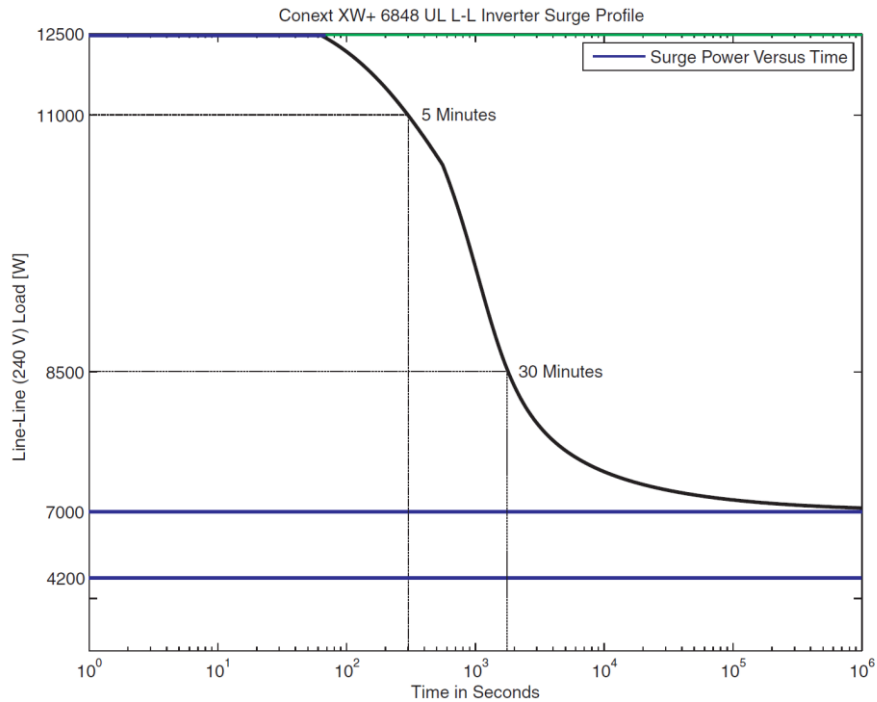

Figure 17.0 – Conext WX+ Operating Time vs 240VAC Load Graph

A.4 – Schneider Electric Conext XW+ 6848 NA AC Overload Capability

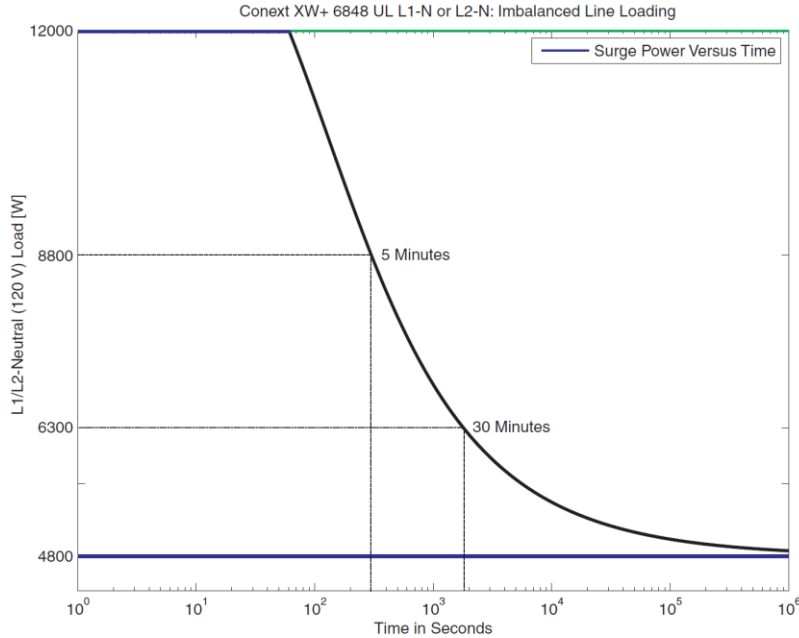

Figure 18.0 - Conext WX+ Operating Time vs 120VAC Load Graph

A.5 – Schneider Electric Conext XW+ Output Power Versus Ambient Temperature

When the internal temperature of the Conext XW+ exceeds a preset limit, it begins to limit output power automatically to stop maximum internal temperatures from being exceeded.

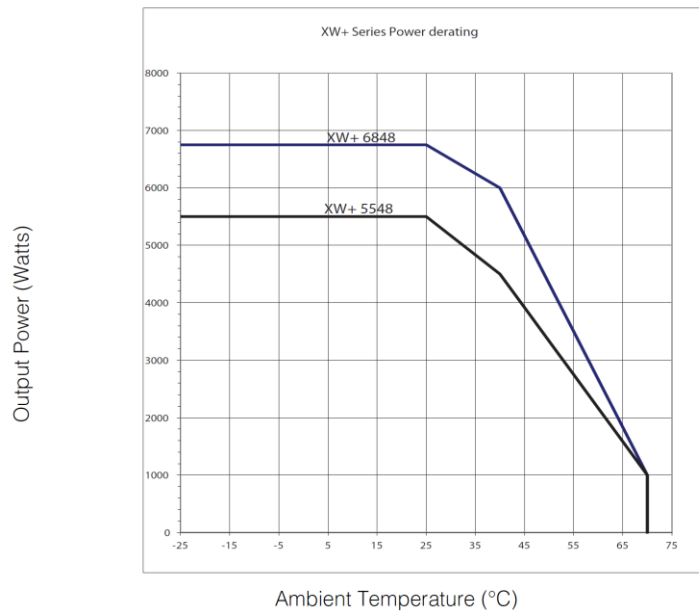

Figure 19.0 - Conext WX+ Operating Temperature vs Load Graph

A.6 – Schneider Electric Conext XW+ Inverting Efficiency (Typical)

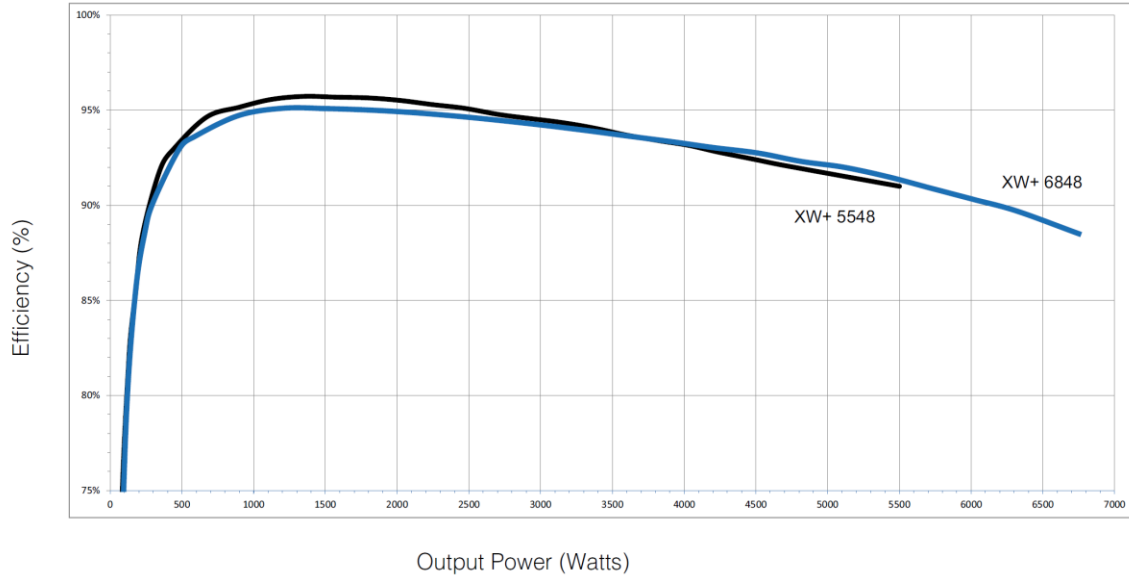

Figure 20.0 - Conext WX+ Efficiency vs Load Graph

A.7 – Schneider Electric Conext XW+ Charging Efficiency (Typical)

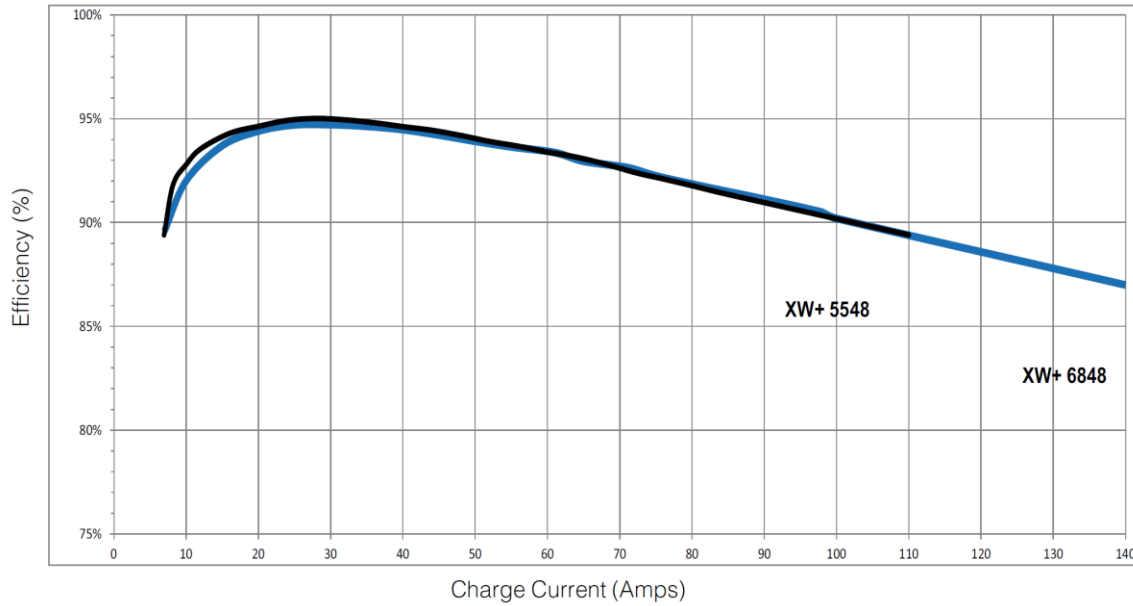

Figure 21.0 - Conext WX+ Charge Efficiency vs Current Graph

A.8 – Schneider Electric Conex XW+ Charging Power Factor

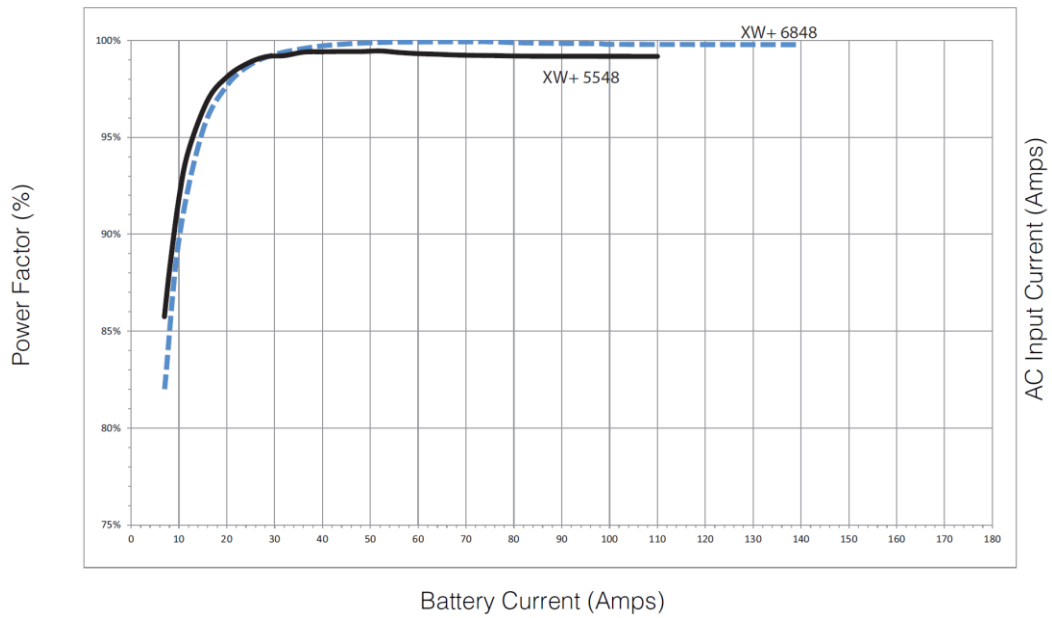

Figure 22.0 - Conex WX+ Charging Power Factor vs Current Graph