



MATE3

System Display and Controller

Owner's Manual



About OutBack Power Technologies

OutBack Power Technologies is a leader in advanced energy conversion technology. Our products include true sine wave inverter/chargers, maximum power point tracking charge controllers, and system communication components, as well as circuit breakers, batteries, accessories, and assembled systems.

Contact Information

Telephone: +1.360.435.6030 (North America)
+1.360.618.4363 (Technical Support)
+1.360.435.6019 (Fax)

Mailing Address: OutBack Power Technologies
(North America) 5917 – 195th Street N.E., #7
Arlington, WA 98223 USA

Address: Sales, Marketing, & Warranty
6115 – 192nd Street NE
Arlington, WA 98223 USA

E-mail: Support@outbackpower.com

Web Site: www.outbackpower.com

Disclaimer

UNLESS SPECIFICALLY AGREED TO IN WRITING, OUTBACK POWER TECHNOLOGIES:

(a) MAKES NO WARRANTY AS TO THE ACCURACY, SUFFICIENCY OR SUITABILITY OF ANY TECHNICAL OR OTHER INFORMATION PROVIDED IN ITS MANUALS OR OTHER DOCUMENTATION.

(b) ASSUMES NO RESPONSIBILITY OR LIABILITY FOR LOSS OR DAMAGE, WHETHER DIRECT, INDIRECT, CONSEQUENTIAL OR INCIDENTAL, WHICH MIGHT ARISE OUT OF THE USE OF SUCH INFORMATION. THE USE OF ANY SUCH INFORMATION WILL BE ENTIRELY AT THE USER'S RISK.

Warranty Summary

OutBack Power Technologies Inc. warrants that the products it manufactures will be free from defects in materials and workmanship for a period of five (5) years subject to the conditions set forth in the warranty detail, found inside the back cover of this manual.

OutBack Power Technologies cannot be responsible for system failure, damages, or injury resulting from improper installation of their products.

Notice of Copyright

MATE3 System Display and Controller Owner's Manual © November 2011 by OutBack Power Technologies. All Rights Reserved.

Trademarks

OutBack Power is a registered trademark of OutBack Power Technologies.

Date and Revision

November 2011, Revision C

Part Number



900-0117-01-00 Rev C

Important Safety Instructions

READ AND SAVE THESE INSTRUCTIONS!

This manual contains important safety instructions for the MATE3 System Display and Controller. Read all instructions and cautionary markings on the MATE3 and on any accessories or additional equipment included in the installation. Failure to follow these instructions could result in severe shock or possible electrocution. Use extreme caution at all times to prevent accidents.

Symbols Used

	WARNING: Hazard to Human Life This type of notation indicates that the hazard could be harmful to human life.
	CAUTION: Hazard to Equipment This type of notation indicates that the hazard may cause damage to the equipment.
	IMPORTANT: This type of notation indicates that the information provided is important to the installation, operation, and/or maintenance of the equipment. Failure to follow the recommendations in such a notation could result in voiding the equipment warranty.

Audience

This manual is intended for use by anyone required to install and operate this equipment. Be sure to review this manual carefully to identify any potential safety risks before proceeding. The operator should be familiar with all the features and functions of this equipment before proceeding. Failure to install or use this equipment as instructed in this manual can result in damage to the equipment that may not be covered under the limited warranty.

Important Safety Instructions



Definitions

The following is a list of initials, terms, and definitions used in conjunction with this product.



Table 1 Terms and Definitions

Term	Definition
AC	Alternating Current; refers to voltage produced by the inverter, utility grid, or generator
AGS	Advanced Generator Start
AUX	Auxiliary switched relay or 12-volt output for OutBack devices
Battery Monitor	<i>See FNDC.</i>
DC	Direct Current; refers to voltage produced by the batteries or renewable source
FCC	Federal Communications Commission
FNDC	FLEXnet DC Monitor; battery monitor manufactured by OutBack Power. May be referred to as battery monitor
FX-class	A family of OutBack inverter products, such as the FX, VFX, GTFX, GVFX, and GFX models; used to differentiate them from Radian-class
Grid-interactive, grid-intertie, grid-tie	Utility grid power is available for use and the inverter is a model capable of returning (selling) electricity back to the utility grid
HBX	High Battery Transfer; a function of the MATE3
IEEE	Institute of Electrical and Electronics Engineers; refers to a series of standards and practices for the testing of electrical products
LED	Light-Emitting Diode; refers to indicators used by the inverter and the system display
MPP	Maximum Power Point
MPPT	Maximum Power Point Tracking
PV	Photovoltaic
Radian-class	A family of Outback inverter products, such as the GS models; used to differentiate them from FX-class
RTS	Remote Temperature Sensor; accessory that measures battery temperature for charging
SOC	State of charge of a battery bank, usually as measured by a battery monitor
System display	Remote interface device (such as the MATE3), used for monitoring, programming and communicating with the inverter; also called "remote system display"
Utility grid	The electrical service and infrastructure supported by the electrical or utility company; also called "mains", "utility service", or "grid"

General Safety

	<p>WARNING: Limitations on Use</p> <p>This equipment is NOT intended for use with life support equipment or other medical equipment or devices.</p>
	<p>CAUTION: Equipment Damage</p> <p>Only use components or accessories recommended or sold by OutBack Power Technologies or its authorized agents.</p>
	<p>IMPORTANT:</p> <p>Do not attempt to install this equipment if it appears to be damaged in any way. See the Warranty section for instructions on returning the equipment.</p>

Personal Safety

	<p>WARNING: Personal Injury</p> <ul style="list-style-type: none">➤ Use standard safety practices when working with electrical equipment. (Remove all jewelry, use insulated tools, wear cotton clothing, etc.)➤ Review the system configuration to identify all possible sources of energy. Ensure ALL sources of power are disconnected before performing any installation or maintenance on this equipment. Confirm that the terminals are de-energized using a validated voltmeter (rated for a minimum 1000 Vac and 1000 Vdc) to verify the de-energized condition.
	<p>WARNING: Fire Hazard</p> <p>Do not operate the unit with damaged or substandard cabling.</p>
	<p>CAUTION: Equipment Damage</p> <ul style="list-style-type: none">➤ Strictly enforce clearance requirements and keep all vents clear of obstructions that can inhibit air flow around or through the unit.➤ Sensitive electronics inside the equipment can be destroyed by static electricity. Be sure to discharge any static electricity built up before touching the equipment and wear appropriate protective gear.➤ Do not perform any servicing other than that specified in the installation instructions unless qualified to do so and have been instructed to do so by OutBack Power Technologies Technical Support personnel.

Regulatory Specifications

See page 153 for all specifications and regulatory information, including certifications.

Required Resources

This product is required to be installed according to pertinent safety codes and standards. If installed in the United States, wiring practices must meet the requirements of the National Electrical Code (NEC). If installed in Canada, wiring practices must meet the requirements of the Canadian Electrical Code.

- ~ National Electrical Code (NEC)/NFPA 70, Current Edition
- ~ Canadian Electrical Code C22.1, Current Edition

Additional Resources

The following are references which may be used when installing this equipment. Depending on the nature of the installation, it may be highly recommended to consult any or all of these resources.

- ~ National Electrical Code (NEC)/NFPA 70 Handbook, Current Edition
- ~ UL 1741, Current Edition, Static Inverter and Charge Controllers for Use in Photovoltaic Power Systems
- ~ International Building Code (IBC), Current Edition
- ~ Photovoltaic Power Systems and the 2005 National Electrical Code: Suggested Practices

Recycling Information



IMPORTANT: Recycle Electronics and Batteries

Batteries are considered hazardous waste and must be recycled according to local jurisdiction. Inverters and other electronics contain metals and plastics that should be recycled. The following websites and phone numbers provide additional information for recycling electronic products and batteries.

Earth 911, USA

Web site: <http://www.Earth911.com>
Address: 14646 N. Kierland Blvd., Suite 100
Scottsdale, AZ 85254
Phone: +1.480.337.3025 (direct)

OurEarth.org, USA

There is a place on the website for contacting OurEarth.org using email. No direct email address is provided.

Web site: <http://www.ouearth.org>
Address: P.O. Box 62133
Durham, NC 27715
Phone: +1.410.878.6485

Environmental Protection Agency, USA

Web site: <http://www.epa.gov/wastes/conserv/materials/ecycling/donate.htm>
Address: EPA USA
Office of Resource Conservation and Recovery (5305P)
1200 Pennsylvania Avenue NW
Washington, DC 20460

Keep America Beautiful, USA

Web site: <http://www.kab.org/>
Email: info@kab.org
Address: 1010 Washington Boulevard
Stamford, CT 06901
Phone: +1.203.659.3000 (Main number)
Fax: +1.203.659.3001

National Institute of Recyclers, Mexico

Web site: <http://www.inare.org.mx/>
Email: a57841279@prodigy.net.mx, margarita@inare.org.mx
Phone: +1.55.57.85.9160
Fax: +1.55.57.84.1279

Natural Resources Canada

Web site: <http://www.nrcan-rncan.gc.ca/mms-smm/busi-indu/rec-rec-eng.htm>
Address: 580 Booth
Ottawa, ON K1A 0E8
Phone: +1.613.995.0947
TTY: +1.613.996.4397
(Phone and TTY: Monday to Friday, 8:30 a.m. to 4:30 p.m. ET)

Office of Waste Management, Canada

Web site: http://www.portaec.net/library/recycling/recycling_in_canada.html
Address: Office of Waste Management
Conservation and Protection
Environment Canada
Ottawa, Ontario K1A 0H3
Phone: +1.819.997.2800

EuroRecycle.net, Europe

The following website provides general information about recycling in Europe. It also provides a list of companies and organizations that provide recycling information or assistance.

Web site: <http://euro.recycle.net>
E-mail: <http://euro.recycle.net/cgi-bin/feedback1.cgi?w=27>
(This is an online form providing a means to contact the owners of the website.)



Table of Contents

Important Safety Instructions	1
Symbols Used	1
Audience	1
Definitions.....	2
General Safety	3
Personal Safety.....	3
Regulatory Specifications.....	4
Required Resources	4
Additional Resources	4
Recycling Information	5
Introduction.....	11
Purpose	11
Functions.....	11
Features	11
Installation.....	13
Parts List.....	13
Dimensions.....	13
Location Considerations.....	14
Mounting Considerations	14
Mounting Options.....	15
Installing the MATE3	16
Connecting the MATE3	17
Setting up Communication to the MATE3	22
Connecting a MATE3 Directly to a Computer.....	22
Connecting a MATE3 Indirectly to a Computer on a Network Switch	23
Connecting a MATE3 to a Computer Using a Router (internal to an intranet).....	24
Connecting a MATE3 to a Computer Using a Router (external through the Internet).....	26
Operation	29
Display and LED Status Indicators.....	29
LED Status Indicators	30
Battery LEDs	30
Inverter LED (green)	30
Charger LED (yellow)	30
Generator LED (green).....	31
Events LED (red).....	31
AC Input LED (yellow).....	31
Favorite LED (green).....	31
Displays	32
Power Up Screens	32
Home Screens.....	33
Meter Bars.....	33
Home Screen Types	33
Basic Navigation	37
Soft Keys.....	37
Inverter Input Select Soft Key (FX-class inverters only; Off Grid system type only).....	38
Grid Soft Key	39

Table of Contents

Inverter Soft Key	40
Warning Messages	42
Error Messages	43
Battery Soft Key	46
Charge Controller Soft Key	52
DataLog Screen	53
Graph Screens	54
Hot Keys	55
INVERTER Hot Key	55
CHARGER Hot Key	56
GENERator Hot Key	60
EVENTS Hot Key	61
AC INPUT Hot Key	62
FAVORITE Hot Key	63
Controls and Navigation Keys	64
Removing the Front Cover	64
Control Wheel	65
Navigation Keys (buttons)	66
Adjusting Set Points	68
Programming	69
Types of Settings	70
Set Points	70
Access to the Main Menu	71
Main Menu Structure	72
Settings Menus	73
System Settings	73
System Information	74
Save / Restore Configuration	74
Saving a Configuration to an SD Card	75
Restoring a Configuration from an SD Card	76
Firmware Version	76
Date and Time	77
LCD Display	77
Sound	78
Ethernet Addresses	78
Ethernet Ports	79
Data Stream	79
System Name	79
Installer Information	80
Installer Settings	80
Set User Access Level	80
Change Installer Password	81
Challenge Installer Password	81
Inverter Settings	82
Search Menu	82
AC Input and Current Limit	83
Grid AC Input Voltage Limits (FX-class only)	85
Gen AC Input Voltage Limits (FX-class only)	85
Grid AC Input Mode and Limits (Radian-class only)	86
Gen AC Input Mode and Limits (Radian-class only)	87
AC Output	88
Low Battery	88
Battery Charger	89
Battery Equalize	89
Auxiliary Output (AUX Modes, FX-class only)	90
Auxiliary Output (AUX Modes, Radian-class only)	93
Auxiliary Relay (AUX Modes, Radian-class only)	96
Inverter Stacking	99
Grid-Tie Sell	101

Calibrate	102
Reset the Inverter to Factory Defaults	103
Charge Controller Settings	104
Charger	104
MPPT	105
Temperature Compensation.....	106
Battery Equalize	106
Grid-Tie Mode.....	107
Auxiliary Output on the Charge Controller	107
Aux Modes for the Charge Controller.....	108
Restart Mode.....	110
Calibrate	110
Reset Charge Controller to Factory Defaults.....	111
Battery Monitor Settings.....	112
Battery Setup.....	112
Shunt Enable.....	112
FLEXnet Relay Mode	113
FLEXnet Relay Set Points	113
Reset FLEXnet DC to Factory Defaults.....	114
MATE3 Settings.....	115
Advanced Generator Start (AGS) Mode	115
AGS Setup.....	116
AGS Functional Test.....	117
AGS Voltage Start	118
AGS Load Start	118
AGS State-of-Charge (SOC) Start.....	119
AGS Must Run Schedule.....	119
AGS Quiet Time Schedule.....	119
AGS Generator Exercise Schedule	120
Set Generator Total Run Time	121
AGS Timers	121
Data Logging.....	122
Data Log File Format	123
High Battery Transfer (HBX).....	124
Grid Use Time	125
Charge Controller Float Coordination	127
Global Charger Output Control	127
FLEXnet DC Advanced Control	128
Reset MATE3 to Factory Defaults Screens.....	129
Configuration Wizard.....	130
Creating New Configurations	130
Using Existing Configurations	132
Restoring Configurations	135
Applying the Profile to the System	137
Saving the Profile to an SD Card	138
Device Data Logs	139
Saving Data Logs for the FLEXmax Charge Controller	139
Saving Data Logs for the FLEXnet (FN) Battery Monitor	140
Erasing Data Logs for the FLEXnet Battery Monitor.....	141
Event Logs.....	142
To Save an Event Log.....	142
To Read an Event Log File from the SD Card	143
To Delete an Event Log	144
Firmware Update.....	145
Saving the Update to the SD Card.....	145
Installing the Firmware Update.....	147
Troubleshooting	149
Basic Troubleshooting of the MATE3	149

Table of Contents

Event Messages.....	150
Start and Stop Reasons for the AGS Function.....	152
Specifications	153
Mechanical Specifications.....	153
Regulatory Specifications.....	153
Firmware Revision.....	153
FCC Information to the User.....	154
Menu Maps.....	161
Main Menu.....	162
SETTINGS: System Menu Map (with User Access Levels)	163
SETTINGS: FX-class Inverter Menu Map (with User Access Levels)	164
SETTINGS: Radian-class Inverter Menu Map (with User Access Levels)	165
SETTINGS: Charge Controller Menu Map (with User Access Levels)	166
SETTINGS: FLEXnet DC Menu Map (with User Access Levels)	167
SETTINGS: MATE3 Menu Map (with User Access Levels).....	168
Configuration Wizard.....	169
New Configurations.....	169
Existing Configurations	170
Restoring Configurations.....	171
Setup Complete Screen	172
Device Data Logs.....	173
FLEXmax Charge Controller Data Logs	173
FLEXnet DC Battery Monitor Data Logs	174
Event Logs.....	175
Product Registration	177
Warranty	179
How to Arrange for Warranty Service	180
Contacting OutBack.....	180
Troubleshooting	180
Return Material Authorization (RMA).....	180
Returning Product to OutBack.....	181
Out of Warranty	181
Index	183



Introduction

Purpose

A renewable energy system requires some combination of inverter/chargers, batteries, charge controllers, and a renewable energy power source, as well as often interfacing with a generator. All of these components need to be adjusted and monitored for optimum performance. The MATE3 System Display and Controller (MATE3) provides that ability to monitor and program each OutBack component.

Functions



IMPORTANT:

The MATE3 is not intended for use with 32-volt inverters.

Specifically, the MATE3:

- Communicates with FX Series inverters and Radian Series inverters, as well as OutBack charge controllers.
- Coordinates system operation, maximizes performance, and prevents multiple products from conflicting with each other.
- Permits adjustments to individual products and to the overall power system, including battery charging. Four different levels of access prevent users from changing settings that could potentially damage or disrupt the system.
 - ~ Switches among different components
 - ~ Views the status of each component
 - ~ Programs individual elements in the system, and also programs system-wide functions
- Programs when an inverter connects to an AC source based on time, battery voltage, or time-of-day grid usage.
- Signals a two-wire generator using the Advanced Generator Start (AGS) mode based on voltage, load, time of day, and the state of charge of the batteries.
- Controls auxiliary AC or DC loads such as cooling fans and relays.
- Links up to ten OutBack Inverter/Chargers and FLEXmax charge controllers. (An OutBack HUB10 Communications Manager is required.)
- Issues a global Bulk or Equalize (EQ) charging command for both the inverters and charge controllers. (An OutBack HUB Communications Manager is required.)

Features

The MATE3 include the following features:

- Six-line graphical LCD display screen for information display
- Four “soft” keys and six “hot” keys for navigation and programming
- Two navigation keys (UP and TOP) for moving through the menu maps for each device
- One PORT key for selecting devices connected to the HUB ports
- One LOCK key to lock access levels to prevent unauthorized changes to settings
- Circular, touch-sensitive control wheel with a button in the center
- One SD memory card slot (up to 4 GB)
- Communication protocol: proprietary OutBack multidrop network
- Interconnecting cable: CAT5 (8 IATIA 518B) PC noncrossover network cable (6 ft/1.8m)
- Maximum tested cable length: 300 feet (100 m) of cable in an office/commercial building
- Computer interface: system monitoring through (read-only) capabilities through a network

Introduction

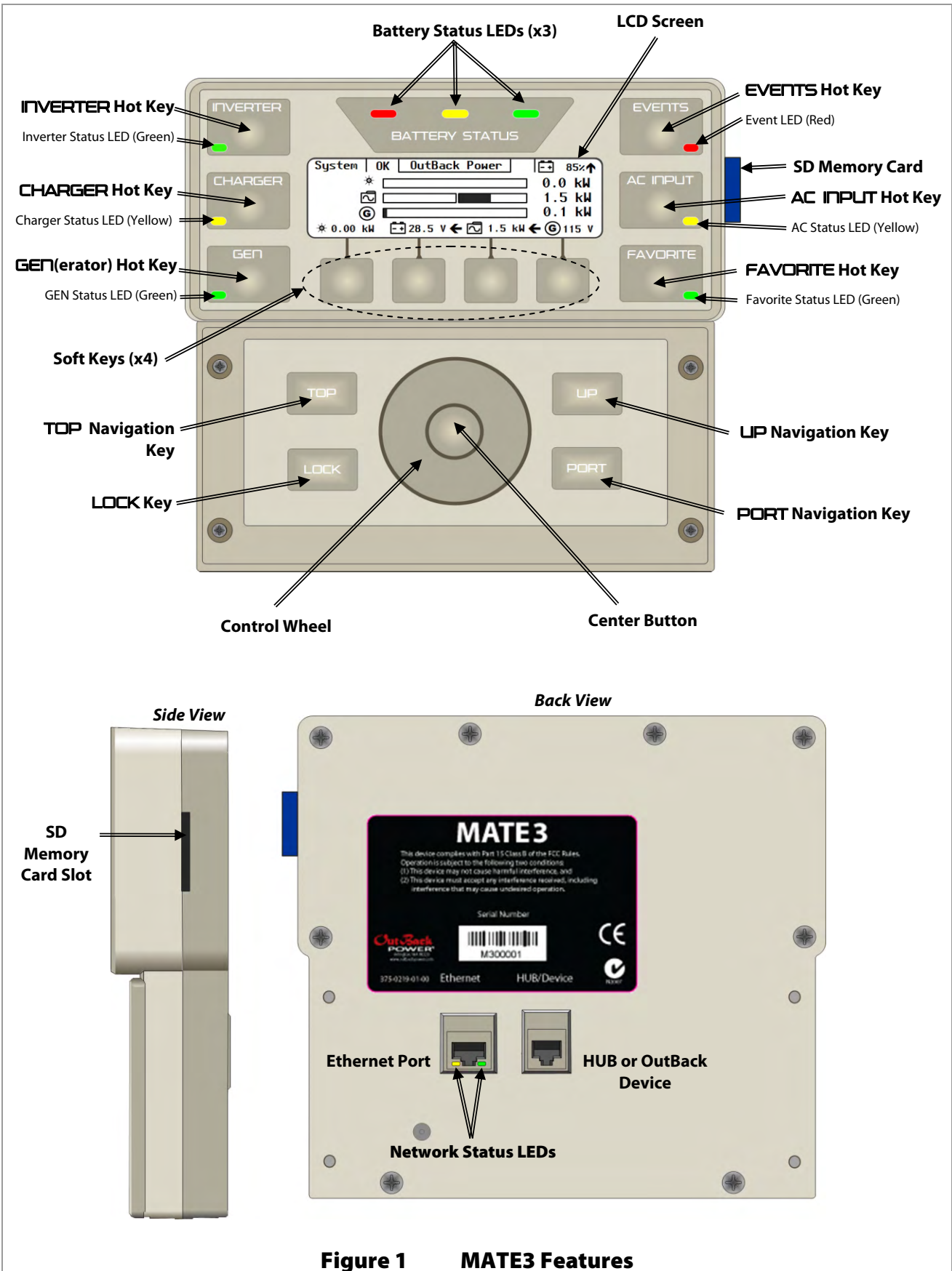

Figure 1 MATE3 Features



Installation

Parts List

The following items are included with the MATE3 System Display and Controller:

- MATE3 (with front cover)
- SD memory card ¹
- 6-foot CAT5 noncrossover cable
- Silicon grease pack
- *MATE3 System Display and Controller Owner's Manual* (this manual)

Dimensions

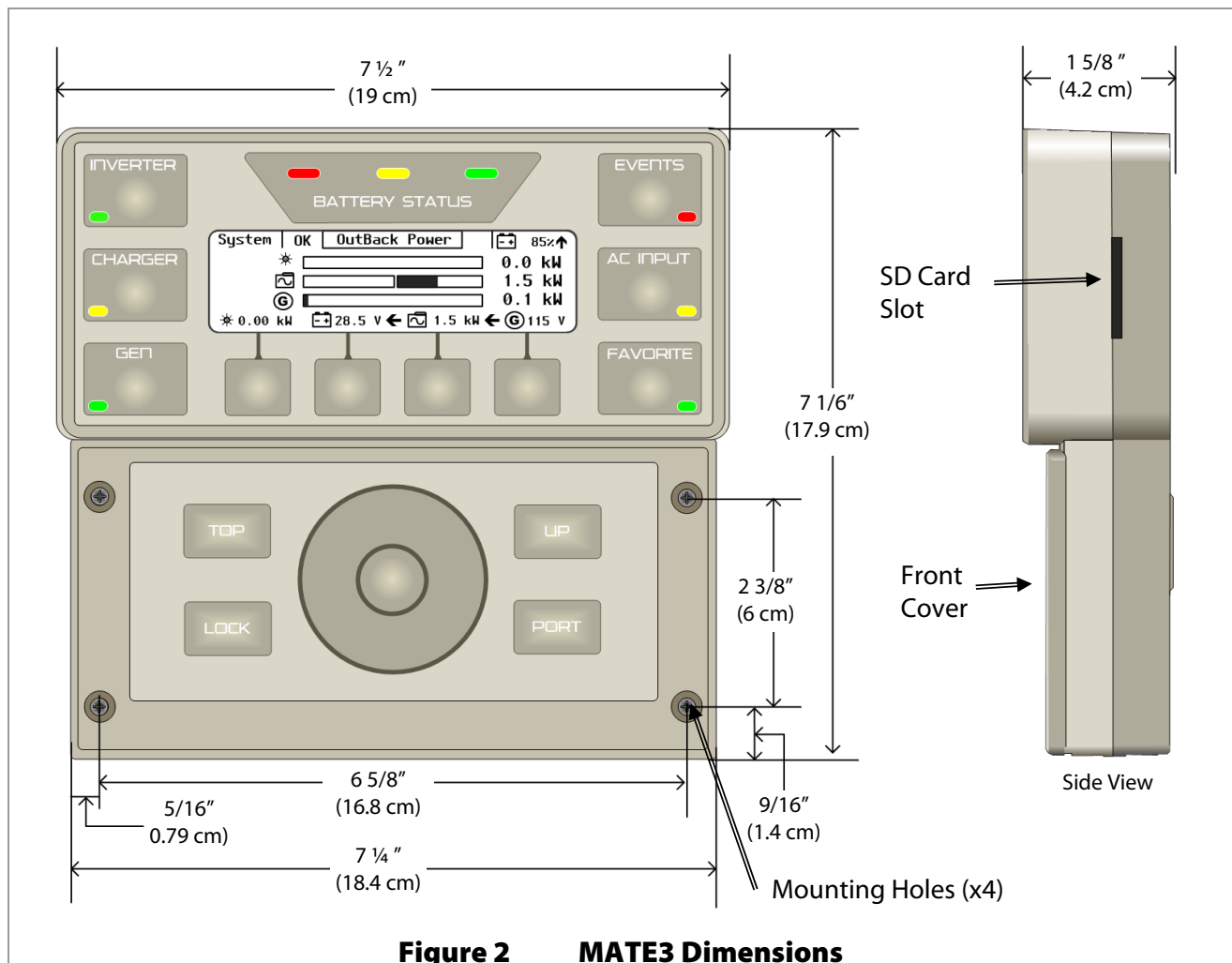

¹ Size may vary depending on availability.

Location Considerations

The following information is important to consider when installing the OutBack MATE3:

- The MATE3 is intended for indoor installations only. Installing the MATE3 outdoors could expose it to damaging environmental conditions. Such damage is not covered by the limited warranty.
- Readability of the display is affected by direct sunlight. It should be positioned about eye level for easier viewing and access.
- The MATE3 voltage is less than 30 Vdc and is thus considered a “limited energy” circuit normally requiring no conduit. Cable runs must be protected and runs must be in approved conduit when conditions require. Consult the local inspector for specific installation requirements.



IMPORTANT:

Signal degradation can result if cable is run in conduit with AC wiring or in other electrically “noisy” environments; these can affect the maximum length the cable can run without incurring transmission errors.

Mounting Considerations

The MATE3 includes one 6-foot CAT5 cable. When working with CAT5 cables considering the following best practices:

- CAT5 cable is not as strong as standard house wiring and must be handled carefully. Avoid kinking the cable or tearing its outer sheathing.
- Use plastic standoff cable staples, J-hooks, or cable trays to support long runs of CAT5 cable. *Do not splice cables.*

Mounting Options

Mounting bracket kits are sold as accessories for the MATE3 to accommodate different types of installations. These include kits for flat mounting, surface mounting, and FLEXware mounting. Follow the installation instructions included with each bracket for mounting the MATE3.

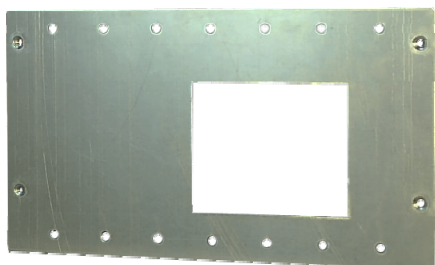

The MATE3 Flat Mount Kit (FW-MB3-F) is used for mounting the MATE3 flat against a wall surface. It consists of a flat mounting plate.

It requires that an electrical outlet box (not provided) be installed in the wall to allow space for the CAT5 cables protruding out of the back of the MATE3. The CAT5 cable is then run through the wall into the electrical outlet box to the MATE3. The MATE3 mounts to the plate with the cable recessed into the wall.

Figure 3 MATE3 Flat Mount Kit (FW-MB3-F)

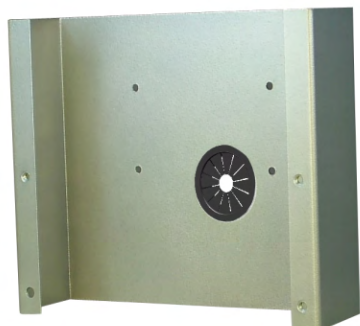

The MATE3 Surface Mount Kit (FW-MB3-S) is used for mounting the MATE3 to a flat surface, but doesn't require any holes in the surface to accommodate the CAT5 cable. It consists of a bracket that holds the MATE3 away from the surface to allow clearance for the CAT5 cable.

Figure 4 MATE3 Surface Mount Kit (FW-MB3-S)

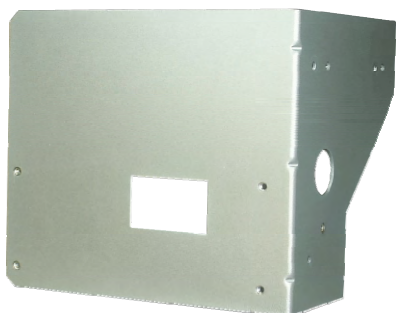

The FLEXware MATE3 Mounting Bracket (FW-MB3) is intended for mounting the MATE3 to a FLEXware assembly, either a FLEXware 1000 or FLEXware 500 AC Enclosure. It is also intended to mount the MATE3 directly to a Radian-class inverter.

Figure 5 MATE3 FLEXware Mount Kit (FW-MB3)

Installation

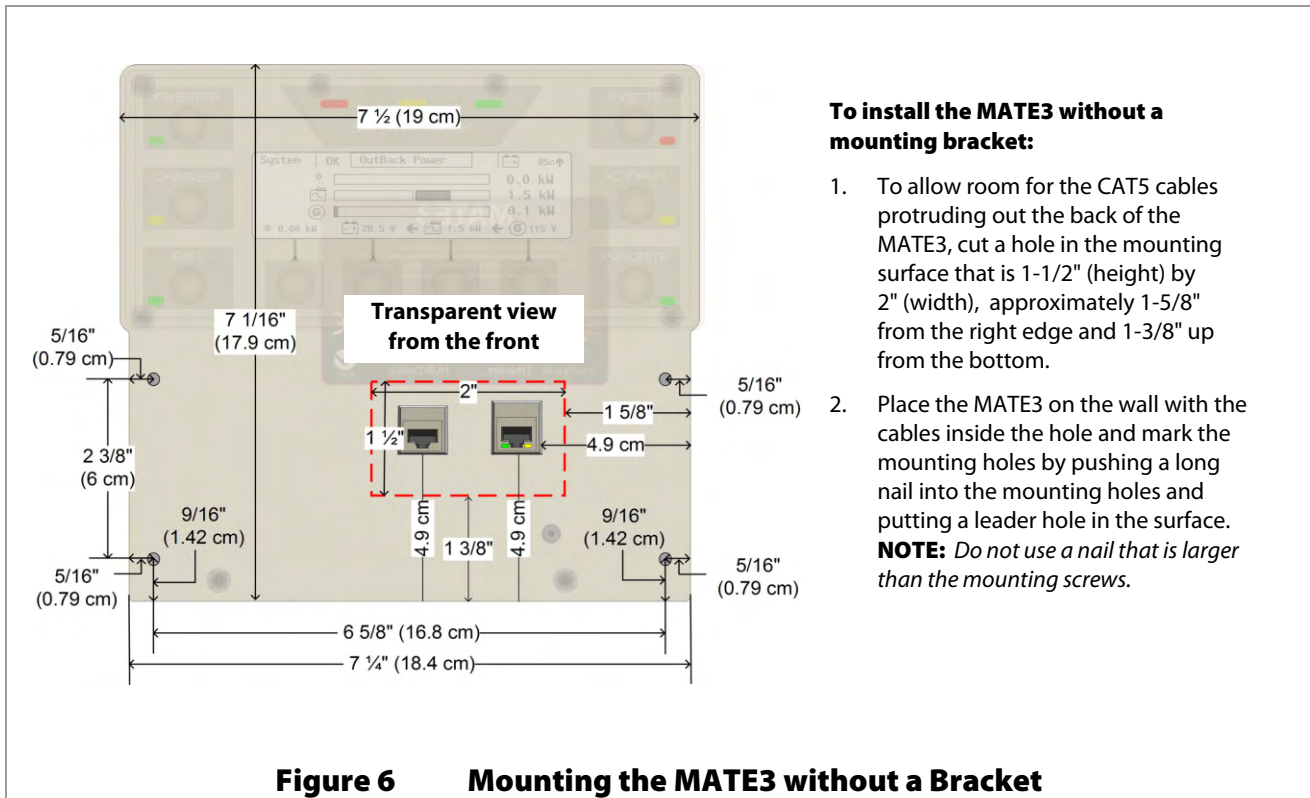

Installing the MATE3

The MATE 3 has several options for installation.

- The MATE3 can be connected directly to an OutBack Inverter/Charger.
- The MATE3 can be connected directly to a FLEXmax Charge Controller.
- The MATE3 can be connected to a HUB4 or HUB10 Communication Manager when other OutBack devices are used in the system, such as charge controllers or multiple inverters.

In addition, the MATE3 can be connected to a computer (*for monitoring only*). This feature uses an online web page to provide a graphic user interface (GUI) for monitoring information on the system. See page 22 for details on this feature. The GUI cannot be used to change settings. The MATE3 can be connected to a computer in one of three ways:

- directly (i.e., MATE3 to computer [requires a crossover CAT5 cable], or MATE3 to network switch to computer [does not require a crossover CAT5 cable]),
- using a network router (i.e., MATE3 to router to computer), or
- using a wireless adapter connecting through a network router with wireless capabilities.



IMPORTANT:

- Connecting the MATE3 to a computer or network router requires advanced knowledge of network protocols and how to manually set IP addresses and port forwarding.
- Installing multiple OutBack devices requires the use of the HUB4 or HUB10 Communication Manager.
- The MATE3 cannot operate with a FLEXnet DC Battery Monitor without an inverter, charge controller, or HUB product in the configuration.

Connecting the MATE3

With the location and mounting options determined, choose one of the options in the previous section and prepare the location accordingly. Follow the instructions below to connect the wiring to the components based on the specific installation. Use the illustrations to identify cable placement.

- MATE3 directly to an inverter or charge controller. See Figure 7.
- MATE3 to HUB Communications Manager that connects to an inverter and a charge controller. See Figure 8.
- MATE3 to a HUB Communications Manager with stacked (multiple) inverters. See Figure 9. (This configuration can also be used for multiple charge controllers.)
- MATE3 to a HUB Communications Manager and directly to a computer. See Figure 10.
- MATE3 to a HUB Communications Manager and indirectly to a computer through a network switch. See Figure 11.
- MATE3 to a HUB Communications Manager directly to a network router that connects to a computer. See Figure 12.
- MATE3 to a HUB Communications Manager indirectly to a network router with wireless capabilities. See Figure 13. See **IMPORTANT** note on page 16 about this configuration.

To connect the MATE3:

1. Locate the position for the MATE3. Prepare the mounting surface according to the type of mounting chosen.
2. Run the CAT5 cable from the source (HUB, inverter, or charge controller) to the MATE3's location. Connect the CAT5 cable to the source.
3. Connect the CAT5 cable to the MATE3 and secure it to the mounting bracket or surface.

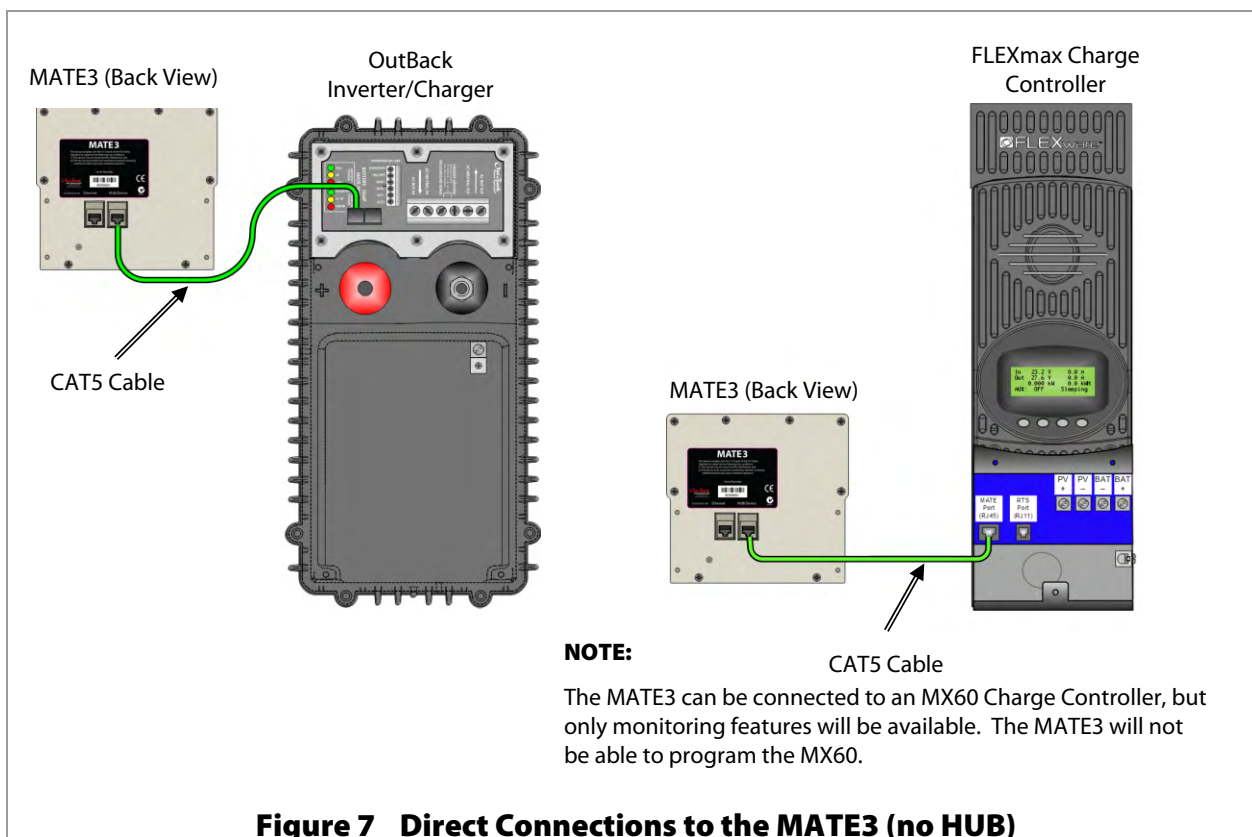

Installation

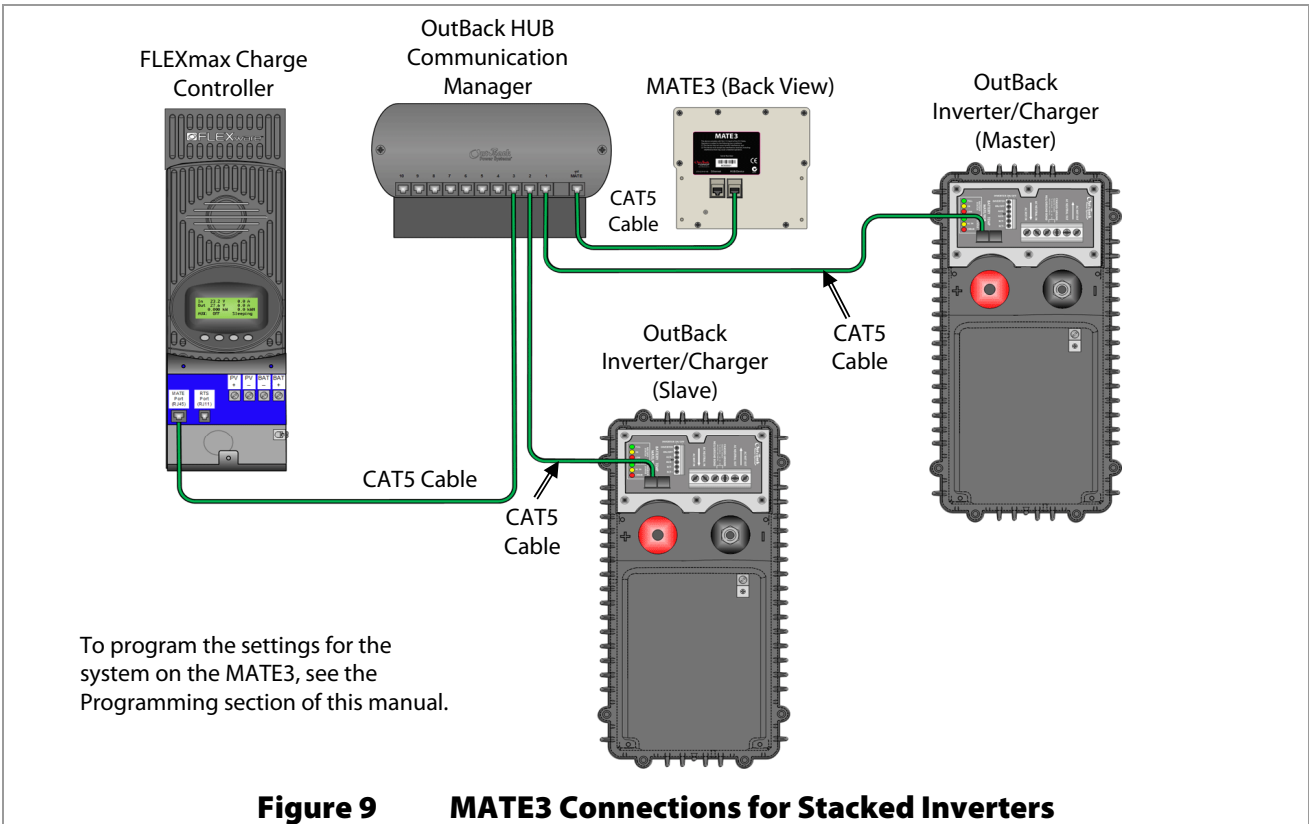
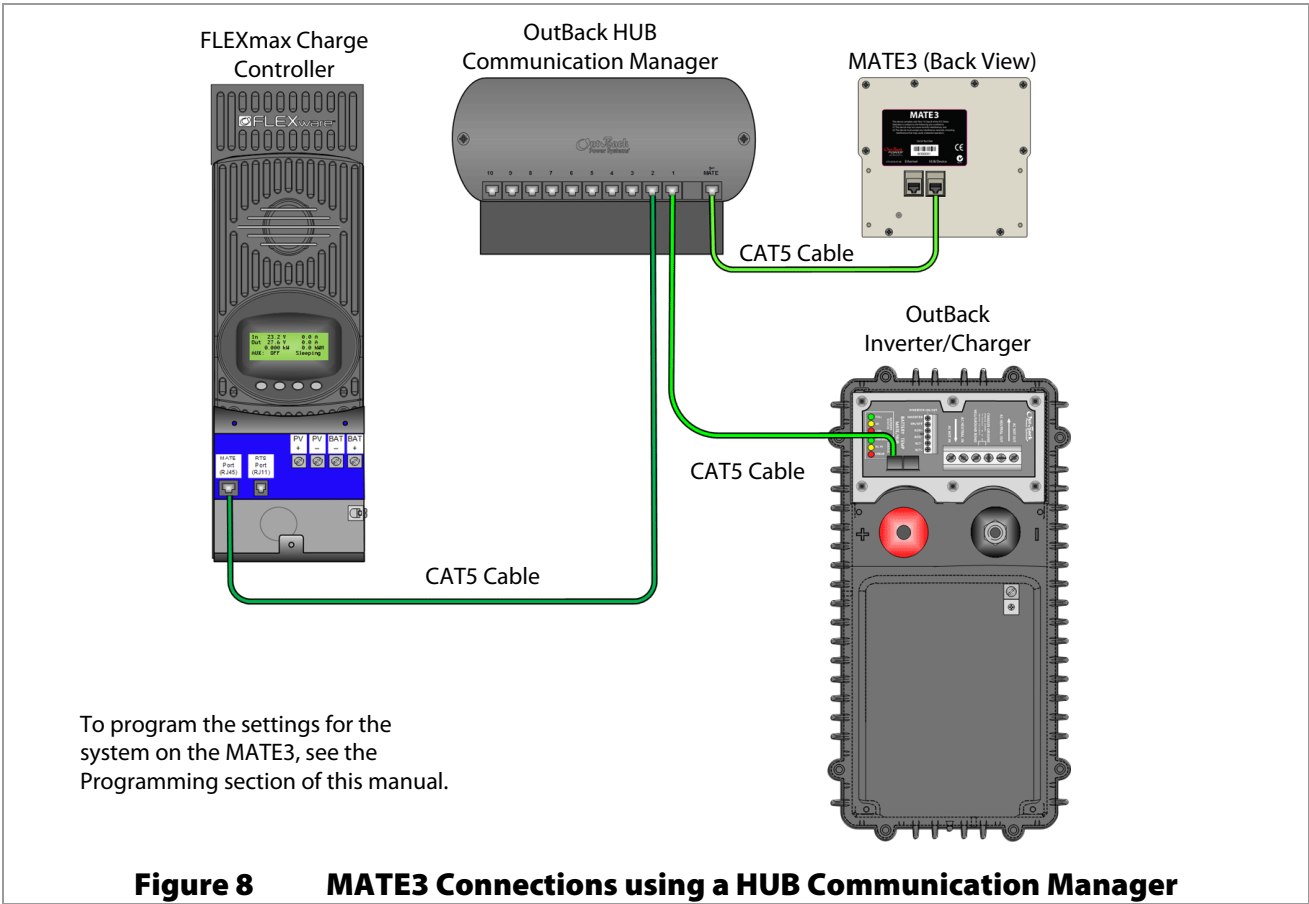

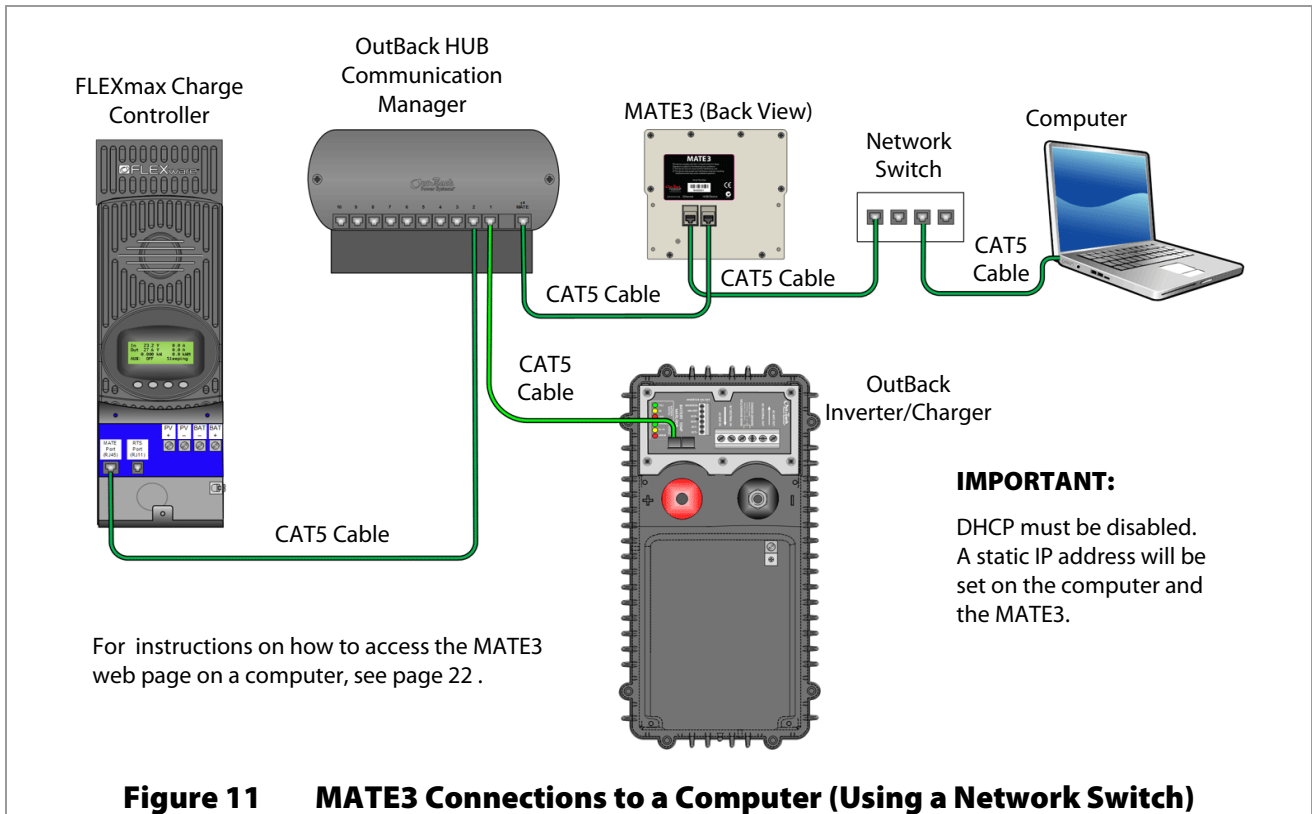
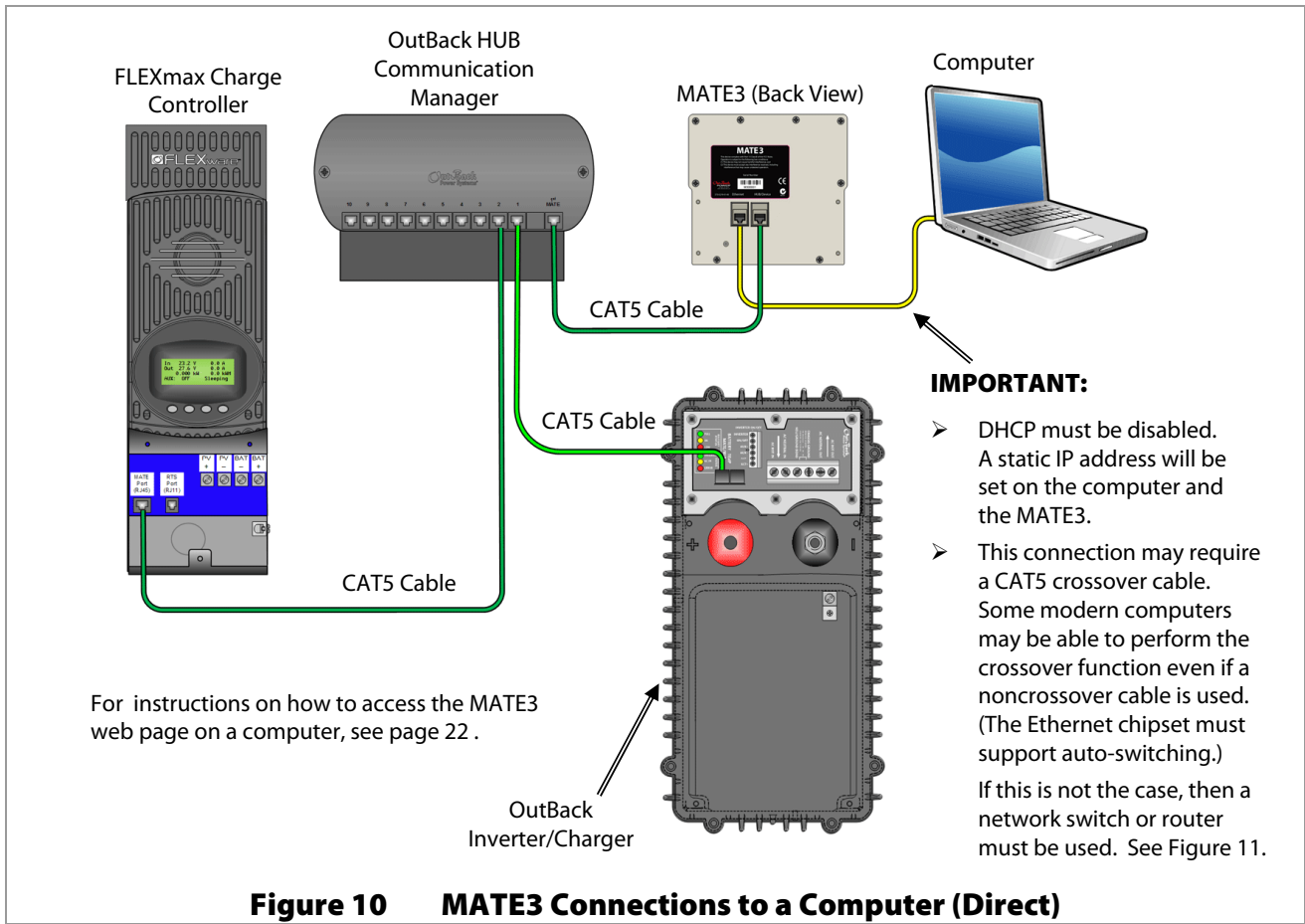

Installation



IMPORTANT:

Connecting the MATE3 to a computer or network router requires advanced knowledge of network protocols and how to manually set IP addresses and port forwarding.

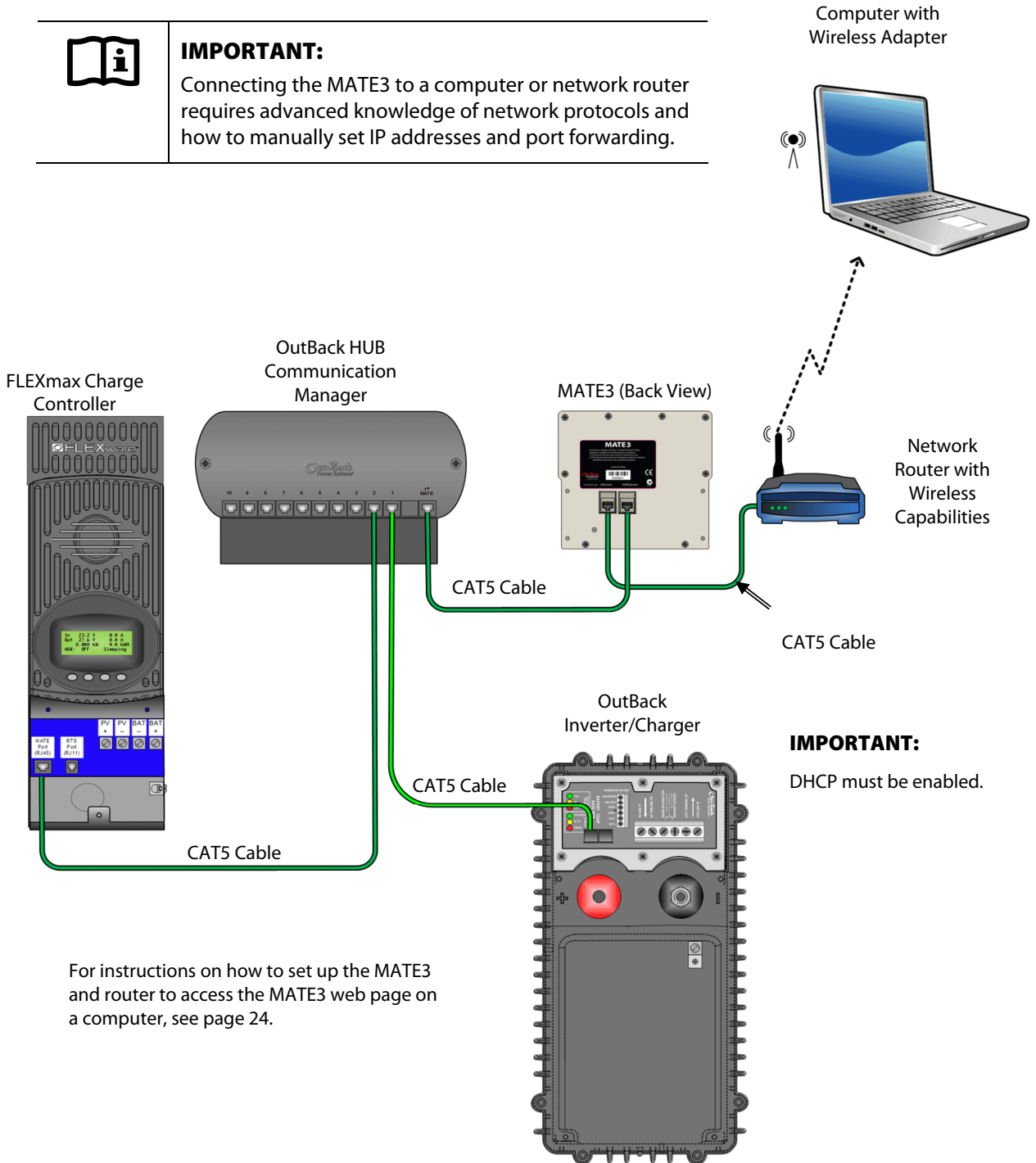

For instructions on how to set up the MATE3 and router to access the MATE3 web page on a computer, see page 24.

IMPORTANT:
DHCP must be enabled.

Figure 12 MATE3 Connections to a Computer (Using a Network Router)



IMPORTANT:

Connecting the MATE3 to a computer or network router requires advanced knowledge of network protocols and how to manually set IP addresses.

For an INTERNET Connection:

- DHCP must be disabled.
- Static IP addresses must be set.
- Port forwarding must be enabled and set.

For an INTRANET Connection:

- DHCP must be enabled.

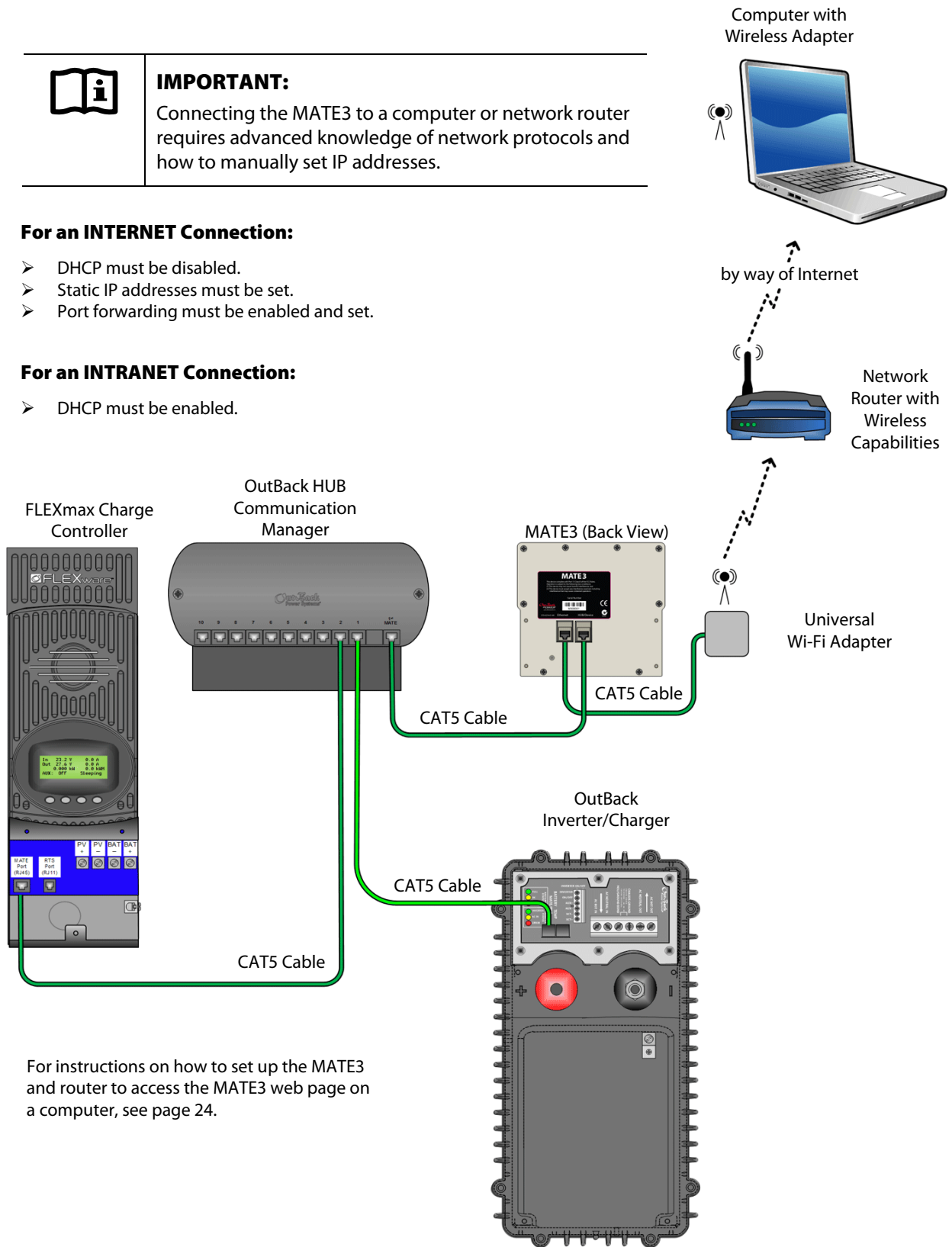

For instructions on how to set up the MATE3 and router to access the MATE3 web page on a computer, see page 24.

Figure 13 MATE3 Connections to a Computer (Wireless-to-Wireless)

Setting up Communication to the MATE3



IMPORTANT:

Use either Mozilla Firefox® or Google Chrome® browsers to view the MATE3 web page on a personal computer. Internet Explorer® may not work properly.

Connecting a MATE3 Directly to a Computer

To access the MATE3 web page directly from the MATE3, follow the instructions below.

REQUIREMENTS:

- MATE3 configured for network communication (see Programming section)
- A computer with networking enabled
- Mozilla Firefox® or Google Chrome® internet browser

Recommended Browsers



Firefox®



Chrome®

Not Compatible



Internet Explorer®

To enable the MATE3 to communicate directly with a computer:

1. Make the connections illustrated in Figure 10.
2. On the computer, open a browser window.
3. In the address bar of the browser, type in the number **192.168.0.64** and press the ENTER key.

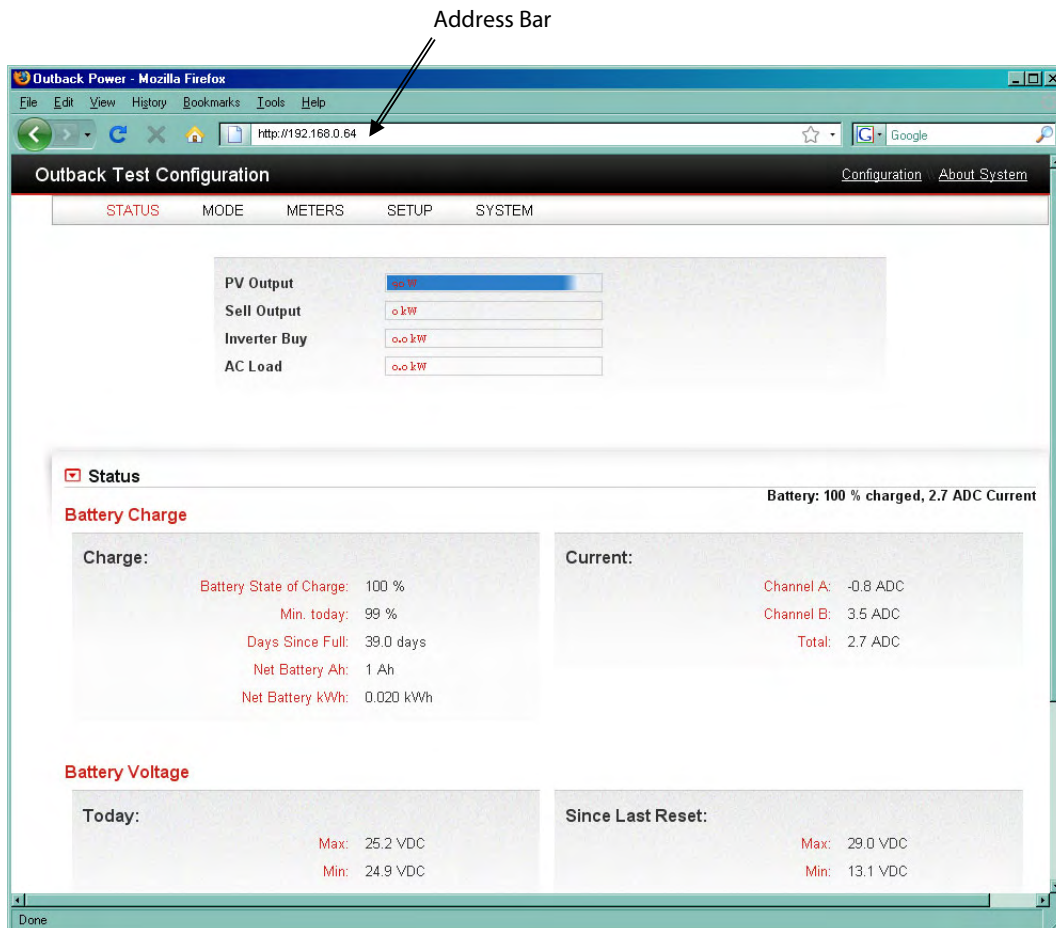

Figure 14 Accessing the MATE3 Directly Using a Computer

Connecting a MATE3 Indirectly to a Computer on a Network Switch

To access the MATE3 web page using a network switch, follow the instructions below.

REQUIREMENTS:

- MATE3 configured for network communication (see Programming section)
- A computer with networking enabled
- Mozilla Firefox® or Google Chrome® internet browser

Recommended Browsers



Firefox®



Chrome®

Not Compatible



Internet Explorer®

To enable the MATE3 to communicate with a computer connected to a network switch:

1. Make the connections illustrated in Figure 11. Ensure the computer has a static IP address (for example, 192.168.0.63). Ensure it has the same netmask and gateway IP as the MATE3.
2. Ensure no other components on the network use the IP address **192.168.0.64**. If there are other components with that same IP address, then the MATE3's IP address *must be changed*. See page 78 for instructions on changing the MATE3's IP address.
3. On the computer, open a browser window.
4. In the address bar, type in the number **192.168.0.64**. (Or if the MATE3's IP address was changed, type in the new number.)

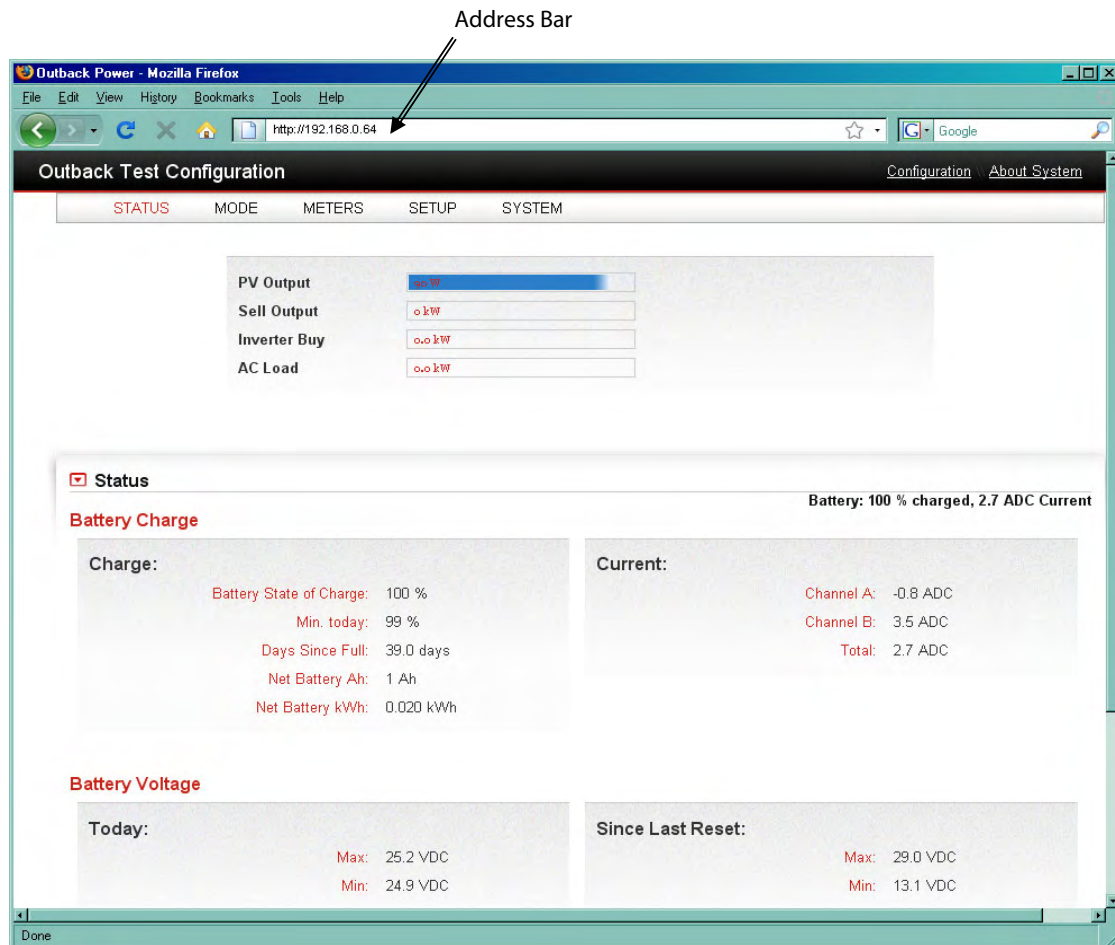

Figure 15 Accessing the MATE3 Using a Computer on a Network Switch

Connecting a MATE3 to a Computer Using a Router (internal to an intranet)



IMPORTANT:

Connecting the MATE3 to a computer or network router requires advanced knowledge of network protocols.

To access the MATE3 web page using a router that is connected to an internal intranet, follow the instructions below.

REQUIREMENTS:

- MATE3 configured for network communication (see Programming section)
- A computer with networking enabled
- A universal wireless adapter for the MATE3 (optional)
- Mozilla Firefox® or Google Chrome® internet browser
- Access to a router with wireless capabilities

Recommended Browsers



Firefox®



Chrome®

Not Compatible



Internet Explorer®

To enable the MATE3 to communicate with a computer connected to a router on an intranet:

1. Make the connections illustrated in Figure 12 or Figure 13.

On the MATE3:

2. Go to the **Ethernet Addresses** screen in the MATE3 **System Settings** and **ENABLE DHCP**.
3. Press the center button on the control wheel to set these changes on the MATE3.
4. Identify the IP address assigned to the MATE3. To determine what the IP address is, press the **<PORT>** key from the Home screen.

See Programming on page 78 for instructions on accessing the **System Settings** on the MATE3.

See the manufacturer's instructions for setting up the router.

Ethernet Addresses	
DHCP Enabled	IP Address 192.168.000.064
	Netmask 255.255.255.000
	Gateway 192.168.000.001
	DNS-1 192.168.000.002
	DNS-2 192.168.000.003

IP Address	192.168.000.064
Netmask	255.255.255.000
Gateway	192.168.000.001
DNS-1	192.168.000.002
DNS-2	192.168.000.003
MAC	00:12:34:56:78:9A

Home Screen

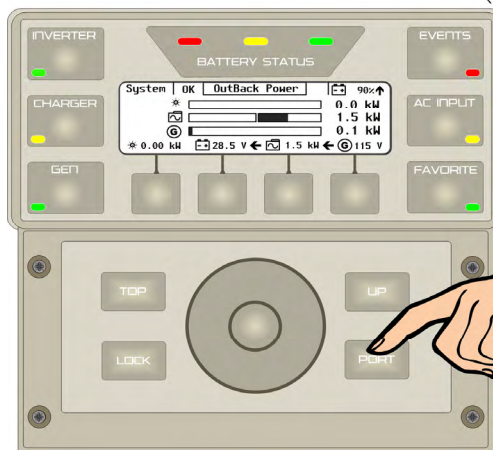

IP Address	192.168.000.064
Netmask	255.255.255.000
Gateway	192.168.000.001
DNS-1	192.168.000.002
DNS-2	192.168.000.003
MAC	00:12:34:56:78:9A

NOTE:

The IP address shown in this example may vary from the actual IP address assigned by the router.

Continued on next page....

Figure 16 Setting up the MATE3 to use a Router on an Intranet

...continued from previous page.

On the computer:

To access the MATE3 web page:

1. Open a browser window.
2. In the address bar, type in the IP address.
Do not include any spaces. (For example: **192.168.0.64**)
3. Press the **Enter** key on the computer keyboard.

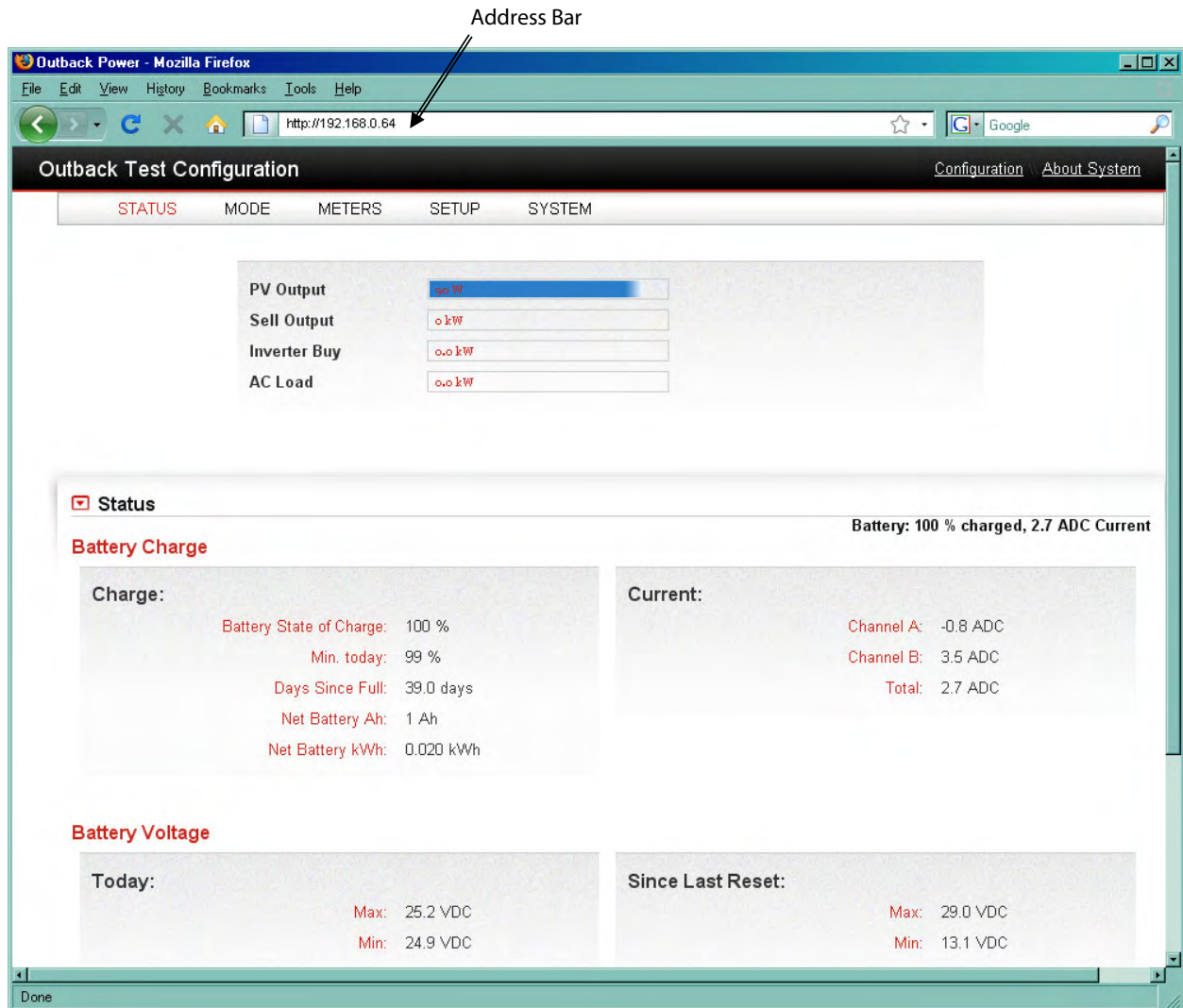

Figure 16 Setting up the MATE3 to use a Router on an Intranet (continued)

Connecting a MATE3 to a Computer Using a Router (external through the Internet)



IMPORTANT:

Connecting the MATE3 to a computer or network router requires advanced knowledge of network protocols and how to manually set IP addresses and enabling port forwarding.

To access the MATE3 web page using a router through the internet, follow the instructions below.

REQUIREMENTS:

- MATE3 configured for network communication (see Programming section)
- A computer with networking enabled
- A universal wireless adapter for the MATE3 (optional)
- Mozilla Firefox® or Google Chrome® internet browser
- Access to a router with wireless capabilities
- Advanced knowledge of establishing static IP addresses and enabling port forwarding in both the router and on the MATE3

Recommended Browsers



Firefox®



Chrome®

Not Compatible



Internet Explorer®

To enable the MATE3 to communicate with a computer connected to a router:

1. Make the connections illustrated in Figure 12 or Figure 13.

On the MATE3:

2. Go to the **Ethernet Addresses** screen in the MATE3 **System Settings** and **DISABLE DHCP**.
3. Change the **IP Address**, **Netmask**, **Gateway**, and **DNS-1** to the appropriate numbers for the network (**DNS-2** is optional). *Ensure these numbers are unique on the network. If any other component has the same numbers, this will NOT work.*
4. Write these numbers down for use later in these instructions.
5. Go to the **Ethernet Ports** screen and change the **HTTP** port to any number above 8000, but no higher than 64000 (for example, 8052). If an FTP port or Telnet port is to be used, then change those settings to the appropriate number as provided by the network administrator. If not, do not change them.
6. Press the center button on the control wheel to set these changes on the MATE3.

Ethernet Addresses	
DHCP	Disabled
IP Address	192.168.000.064
Netmask	255.255.255.000
Gateway	192.168.000.001
DNS-1	192.168.000.002
DNS-2	192.168.000.003

Ethernet Ports	
HTTP	8052
FTP	21
Telnet	23

See Programming on page 78 for instructions on accessing the **System Settings** on the MATE3.

See the manufacturer's instructions for setting up the router.

Continued on next page...

Figure 17 Setting up the MATE3 to use a Router on the Internet

...continued from previous page.

7. Identify the MAC address assigned to the MATE3. This will be a unique number for each MATE3 (for example, 00:12:34:56:78:9A). Every MATE3 will have a different MAC address. To determine what the MAC address is, press the **<PORT>** key from the Home screen.

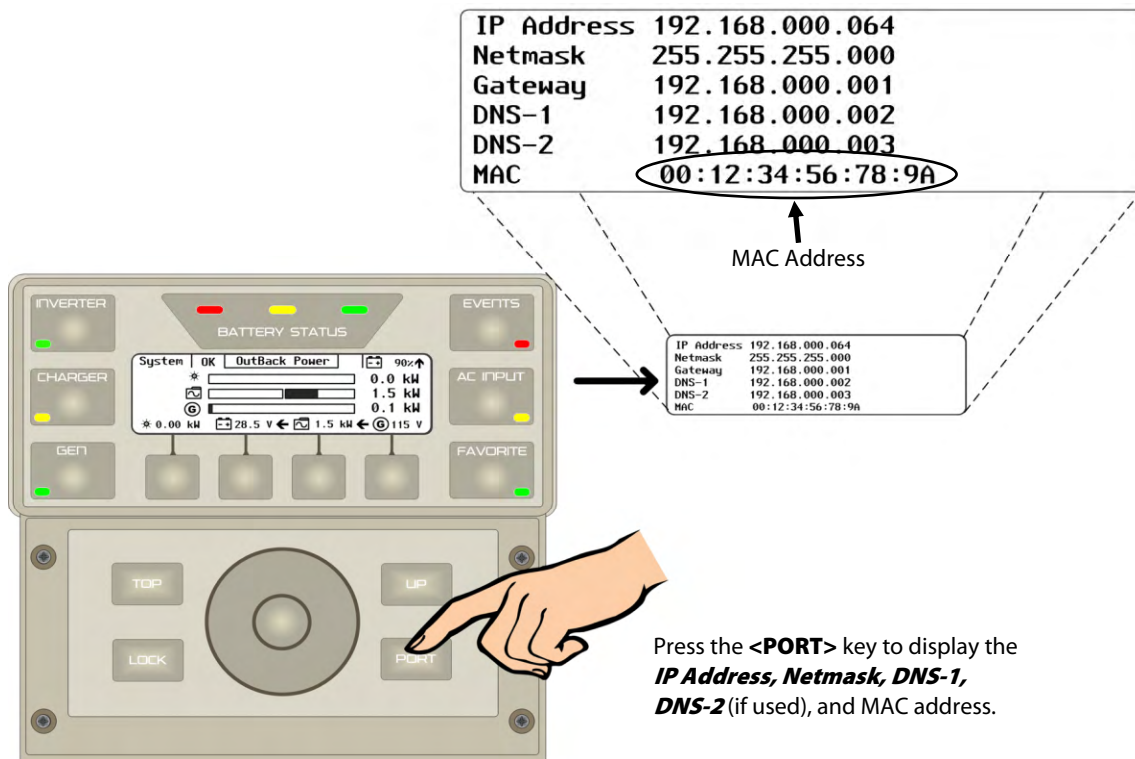

Press the **<PORT>** key to display the **IP Address, Netmask, DNS-1, DNS-2** (if used), and MAC address.

On the router's setup page:



IMPORTANT:

Router setup pages will vary by manufacturer. Consult the manufacturer's documentation for the router in use for specific instructions on making the following settings. Computers will need a hardwired connection to the router to access the router's setup page). After setup is complete, the hardwired connection to the router can be removed.

8. Set a static IP address, netmask, and DNS-1 for the router. Setting DNS-2 is optional.
9. Bind the MAC address of the MATE3 to the IP address set in the MATE3 on the router. See above to identify the MAC address for the MATE3. This will be a unique number for each MATE3.
10. Enable port forwarding on the router.
11. Assign the MATE3's IP address to the designated port (e.g., 8052).

Continued on next page....

Figure 17 Setting up the MATE3 to use a Router on the Internet (continued)

...continued from previous page.

On the computer:

To access the MATE3 web page:

1. Open a browser window.
2. In the address bar, type in the IP address, followed by a colon, then the port number. Do not include any spaces. (For example: **192.168.xxx.xxx:xxxx**)
3. Press the **Enter** key.

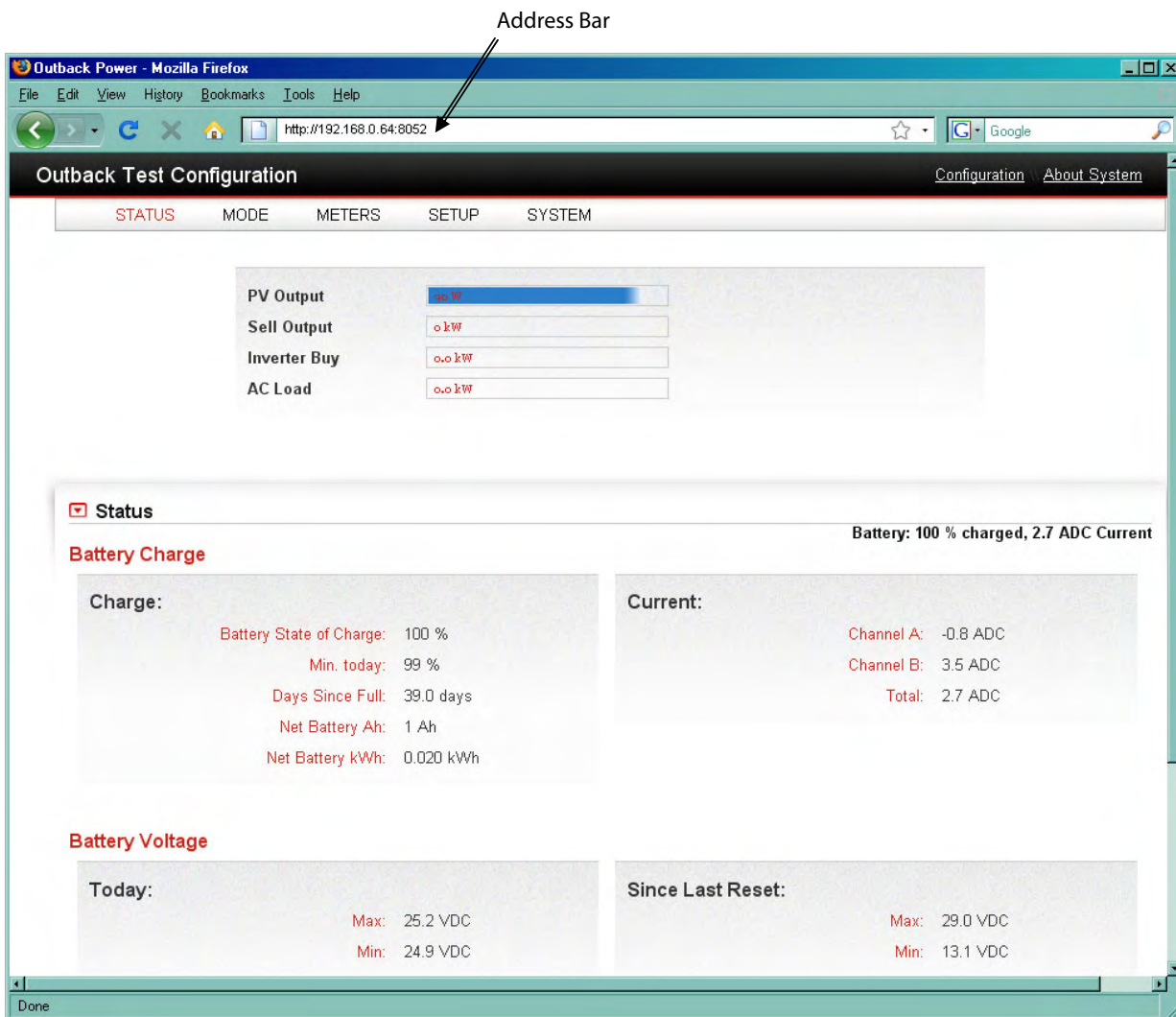

Figure 17 Setting up the MATE3 to use a Router on the Internet (continued)



Operation

The MATE3 provides the means for programming OutBack inverter/chargers, charge controllers, and battery monitors when preprogrammed default settings do not work for the destined installation.

	IMPORTANT: The OutBack inverters have nonvolatile memory and will retain any settings that have been changed, even after the MATE3 is removed. If a system does not have a MATE3, an installer can bring a MATE3 to the site temporarily, install it, change the settings, and then remove it.
	IMPORTANT: Some functions are not based in the inverter or charge controller, but are part of the MATE3's firmware. They will not function if the MATE3 is removed. These functions are listed beginning on page 115.

Display and LED Status Indicators

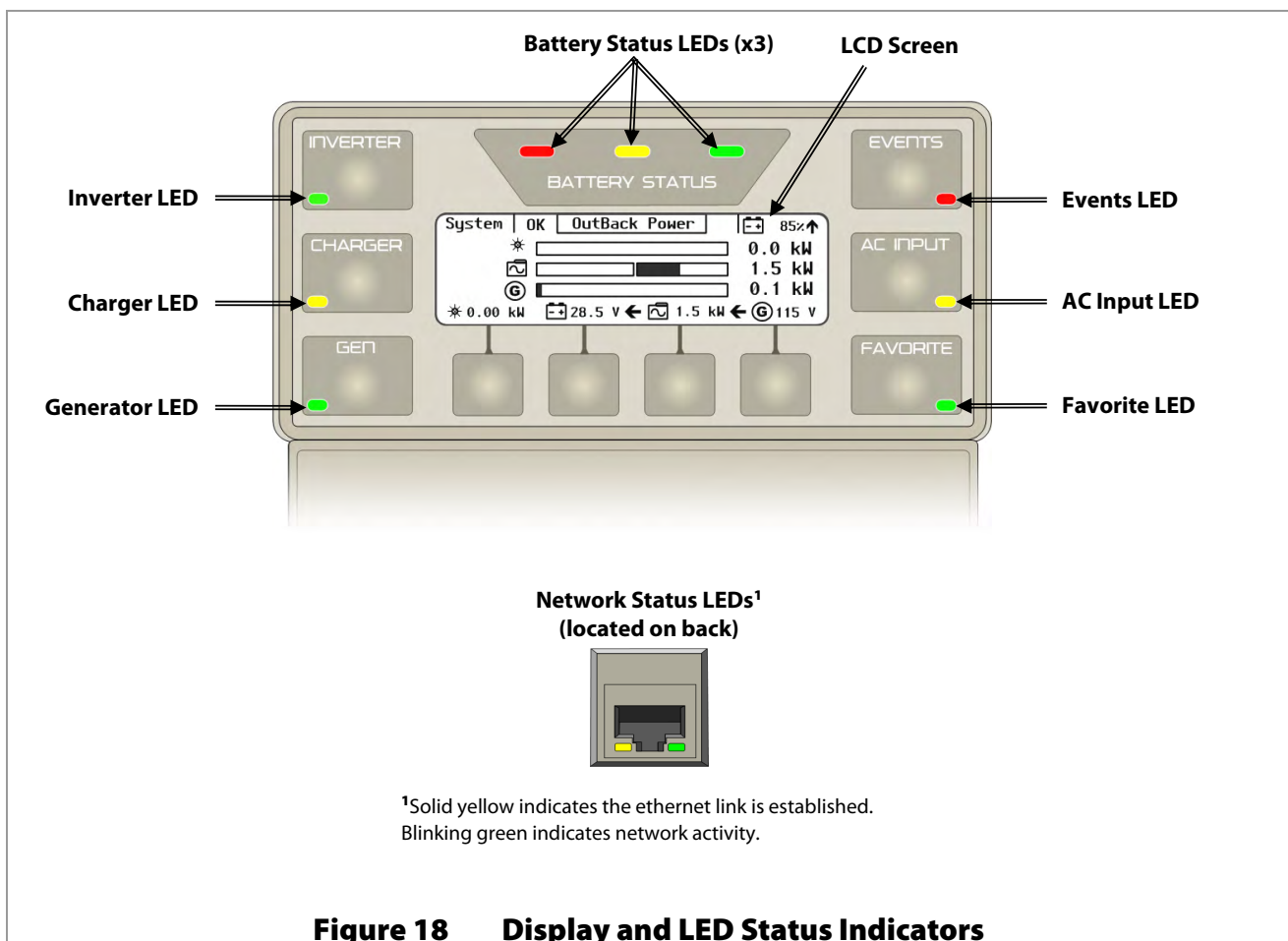

Figure 18 Display and LED Status Indicators

LED Status Indicators

Battery LEDs

Three LEDs provide a visual reference to indicate the condition of the battery bank.

- A GREEN LED means the batteries have an adequate charge at that time. It does not always mean they are full. If an FNDC is installed, this means the batteries are $\geq 80\%$ State of Charge (SOC).
- A YELLOW LED means the batteries are somewhat discharged. If an FNDC is installed, this means the batteries are $\geq 60\%$ and $\leq 70\%$.
- A RED LED means the batteries are greatly discharged and may require attention. If an FNDC is installed, this means the batteries are $< 60\%$. May be accompanied by an event indicator and a **Low Battery V**error. (See pages 31 and 43.)

Table 2 Battery Status LEDs

Color	12 Vdc Unit	24 Vdc Unit, ± 0.2 Vdc	36 Vdc Unit, ± 0.3 Vdc	48 Vdc Unit, ± 0.4 Vdc	Battery Status
GREEN	12.5 Vdc or higher	25.0 Vdc or higher	37.5 Vdc or higher	50.0 Vdc or higher	ACCEPTABLE
YELLOW	11.5 to 12.4 Vdc	23.0 to 24.8 Vdc	34.5 to 37.2 Vdc	46.0 to 49.6 Vdc	USABLE
RED	11.4 Vdc or lower	22.8 Vdc or lower	34.2 Vdc or lower	45.6 Vdc or lower	LOW

NOTES:

- Gaps in the table (higher-voltage units) are due to the resolution of the inverter's DC meter.
- These voltage settings are not the same as the inverter's Low Battery Cut-Out voltage. (See page 88.)
The Battery LED settings cannot be changed.
- Voltages higher than shown in the GREEN row usually means that the batteries are charging.

Inverter LED (green)

This LED is located on the **INVERTER** hot key. (See page 55.) It provides a visual reference for the status of the inverter operation.

- **ON** (solid) — inverter is converting DC to AC in order to power loads.
- **ON** (flashing) — the inverter is in Search mode.
- **OFF** (not illuminated)
 - ~ the inverter is not converting DC power to AC power, or
 - ~ the AC input source is powering the loads.

In stacked configurations, the master inverter controls this LED status. If any inverters in a stacked system have a different inverting status from the master, this LED will not display their status.

Charger LED (yellow)

This LED is located on the **CHARGER** hot key. (See page 56.) It provides a visual reference for the status of the battery charger.

- **ON** (illuminated) — a device on the HUB is delivering more than a minimal amount of charging power. The device may be an inverter or a charge controller.
- **ON** (flashing) — the batteries are being equalized.
- **OFF** (not illuminated) — no device is actively charging the batteries, for several reasons.
 - ~ the charger(s) may be functional, but in a quiescent state such as Silent.
 - ~ the charger(s) may be functional, but the charging sources may be disconnected or unavailable.
 - ~ the charger(s) may be turned off.

Generator LED (green)

This LED is located on the **GEN** hot key. (See page 59.) It provides a visual reference for the status of a generator that is controlled by the Advanced Generator Start (AGS) function. (See page 115.)

- **ON** (illuminated) — The generator is detected to be running after receiving an **ON** command in the **Generator Status** menu. The MATE3 determines the generator is running based on input AC voltage (if the generator type is AC). This LED will usually illuminate in conjunction with the **AC INPUT** LED. This LED will only illuminate when an AC generator is used.
- **OFF** (not illuminated) — The **Generator Status** menu has been set to **OFF**, or the AGS function has not been enabled. If the generator shuts down or stops delivering power, this LED will remain on until a generator fault is declared.

Events LED (red)

This LED is located on the **EVENTS** hot key. (See page 61.) It indicates that an event requires acknowledgement. Generally, this LED only illuminates when a fault occurs.

- **ON** (solid) — An error has occurred. This is usually accompanied by inverter shutdown. This event can also indicate a generator fault if the voltage is lost from an automatic generator. (See page 59.)
- **ON** (flashing) — A warning has occurred.
- **OFF** (not illuminated) — No particular status. Events may be logged in Event History, but they do not require attention.

This LED will remain on until the event has been acknowledged in the **Event Status Detail** menu. (See page 61.) It may be necessary to troubleshoot and deal with the cause of the event. (See pages 42, 43, and 150.) Specific error or warning messages are defined in the inverter *Operator's Manual*.

AC Input LED (yellow)

This LED is located on the **AC INPUT** hot key. (See page 62.) It provides a visual reference for the status of the AC input.

- **ON** (solid) — The AC source is connected and providing power. Unit may or may not be charging the batteries, depending on settings.
- **ON** (flashing) — The AC source is present but has not been accepted. If flashing continues, the unit is refusing the source. This can occur for the following reasons.
 - ~ The AC source may have quality issues. To determine system warnings for AC source problems see page 55 for the Warnings menu. To view AC source measurements see page 62.
 - ~ In the **AC INPUT** hot key menu, the **AC Input Status** is set to **Drop**. See page 62.
 - ~ The HBX function or the Grid Use Time function intentionally disconnected the inverter. (See page 124 and page 125 for descriptions of these functions.)
- **OFF** (not illuminated) — No AC source is detected.

In stacked configurations, the master inverter controls this LED status. If any inverters in a stacked system have a different AC input status from the master, this LED will not display their status.

Favorite LED (green)

This LED is located on the **Favorite** hot key. (See page 63.) It indicates the use of this hot key to select often-used menus for rapid access.

- **ON** (Solid): The hot key has been pressed and a Favorite can be selected.
- **ON** (Flashing): The hot key has been held down to program a Favorite.
- **OFF** (not illuminated): No particular status. The Favorite LED only illuminates in response to the hot key being pressed.

Displays

Power Up Screens

The MATE3 powers up as soon as it is plugged into a powered OutBack product. It will immediately cycle through the startup screens. It will proceed to locate and identify the attached components and the ports they occupy on the HUB. It will then stop on the Home screen.

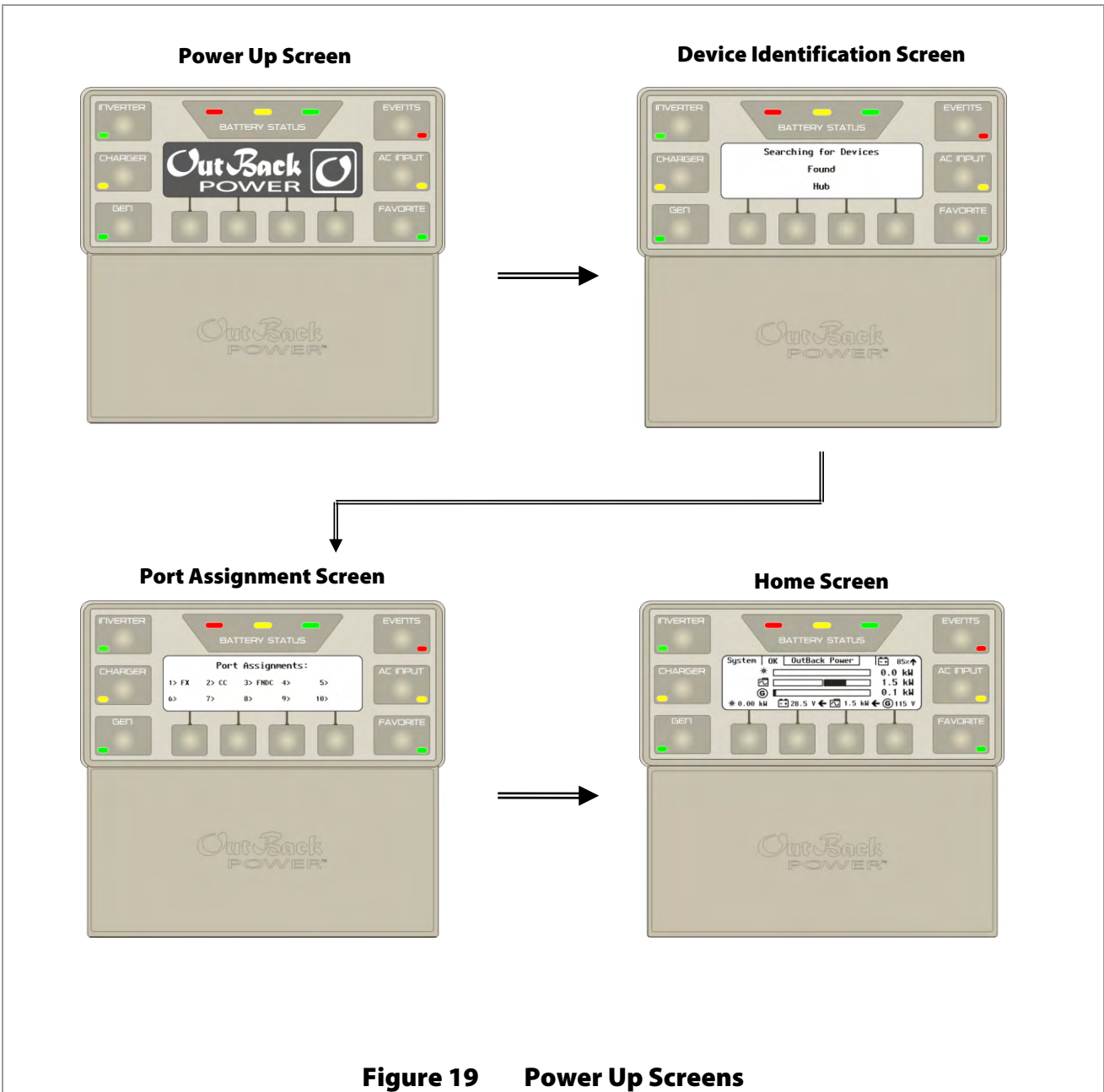

Figure 19 Power Up Screens

Home Screens

The Home screen appears after the MATE3 detects any devices that are connected to it. Home screens contain icons and meter bars that display various types of information depending on the system type selected. There are three different Home screens depending on the system type selected.

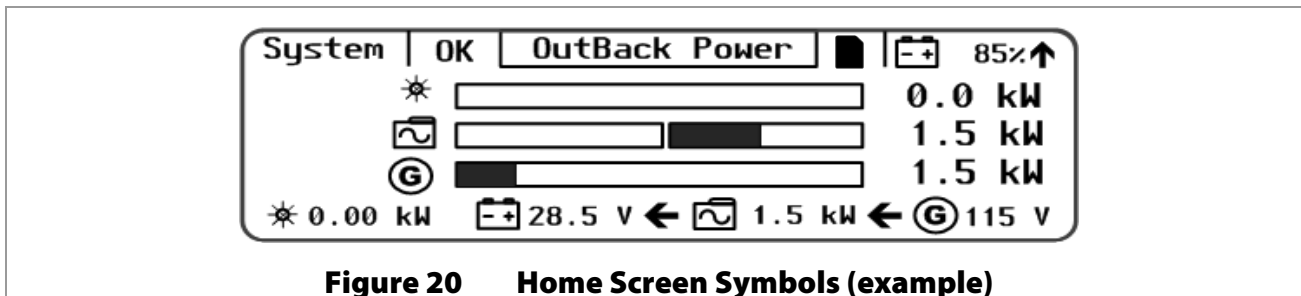

Figure 20 Home Screen Symbols (example)

Meter Bars

Much of the Home screen data is shown by kilowatt meters in the form of black bars. These meter bars expand to the right or to the left with an increase in wattage. The meter bars next to the various icons are based on **System Information** listed on page 74. The scale of a bar will vary with the size set for each element. (Not all data is present in all cases. See Home Screen Types below.)

- The ☀ meter bar represents the charge controller output and is scaled according to the **Array Wattage** setting.
- The left ~ meter bar represents inverter output and is scaled to the **Gen kW Rating** setting. If **Gen Type** is set to DC, this bar is scaled to the **Max Inverter kW** setting.
- The right ~ meter bar represents the inverter’s charger output and is scaled to the **Max Charger kW** setting.
- The G meter bar represents the generator output and is scaled to the **Gen kW Rating** setting.
- The left \$ meter bar represents the power bought from the grid and is scaled to the total of the **Max Inverter kW** and **Max Charger kW** settings.
- The right \$ meter bar represents the amount of power sold by the inverter and is scaled to the **Max Inverter kW** setting.
- In the Grid Tied Home screen, the ⚡ meter bar represents the amount of power being used by the loads and is scaled to the **Max Inverter kW** setting, if the inverter is not in PassThru mode. If the inverter is in PassThru, then it is equal to 7.2 kW multiplied by the number of inverters present on the HUB. For details on PassThru mode see the *Operator’s Manual* for the inverter.
- In the Backup Home screen, the ⚡ meter bar is scaled differently. Please see page 36 for details.

See pages 34 through 36 for the icons and meter bars that are used with each Home screen.

Home Screen Types

The Home screen will vary depending on the “Type” of system installed. The system type is set in the **System Information** screen (see page 74). Three types are available:

- **Off Grid** is for when no utility grid is available. (Default)
- **Grid Tied** is for grid-interactive inverters that are capable of returning power back to the grid. Most commonly used with renewable energy systems.
- **Backup** is for using the inverter system to back up the utility grid.

Off Grid Home Screen

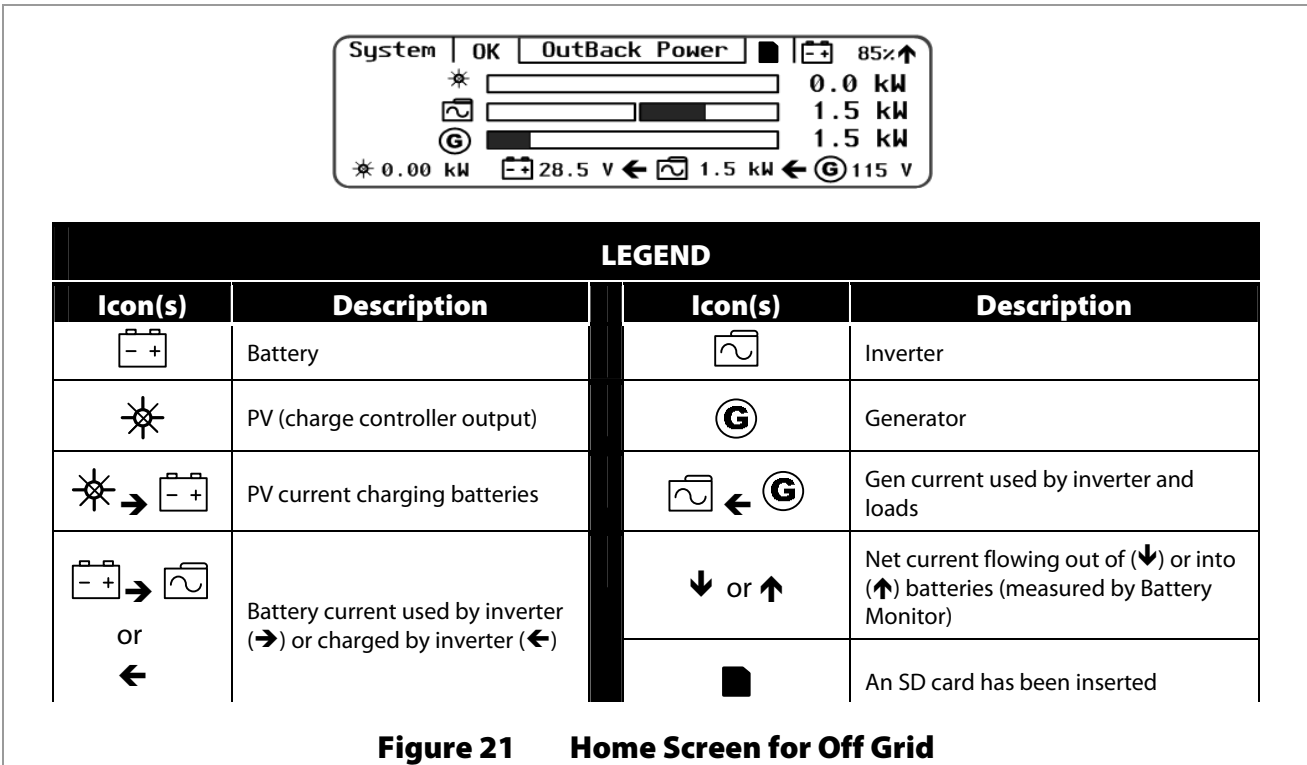

NOTES:

	The generator symbol in the lower right corner of the screen marks a voltmeter that measures the AC voltage of the generator (or AC source). The generator symbol next to the meter bar shows a graphic display of the power being used from the generator (or AC source). This meter expands from left to right.
	The inverter symbol on the bottom of the screen marks a kilowatt meter that measures the amount of power being used by the inverter from the generator (or AC source). The inverter symbol next to the center of the screen actually marks two meter bars. <ul style="list-style-type: none"> ➤ The meter on the left measures the amount of power taken out of the inverter when inverting or supporting loads. This meter bar expands from right to left. ➤ The meter on the right measures the amount of power taken into the inverter when charging. This meter bar expands from left to right.
	The battery symbol on the bottom of the screen marks a voltmeter that measures the uncompensated battery voltage. (For a compensated voltage, see page 41.) The battery symbol in the top right corner of the screen marks a percentage meter that shows the SOC of the batteries as measured by the battery monitor. See page 112 for details. If no battery monitor is present, this figure will be replaced by another voltmeter.
	The PV symbol in the lower left of the screen marks a kilowatt meter that measures the amount of PV power generated. The PV symbol next to the bar shows a graphic display of the PV power generated. This meter bar expands from left to right. If no charge controller is present on the HUB, neither of these symbols will be present.
OK	This symbol indicates that no problems are noted with either the inverter, the generator, or the batteries. <ul style="list-style-type: none"> ➤ If an inverter fault occurs, it will be replaced with the symbols . (An event message will also appear.) ➤ If a generator fault occurs, it will be replaced with the symbols . (An event message will also appear.) ➤ If a battery monitor is present and registers a battery problem, it will be replaced by the symbols or . (An event message will also appear.) See pages 150 and 151 for information on these messages.

Grid Tied Home Screen

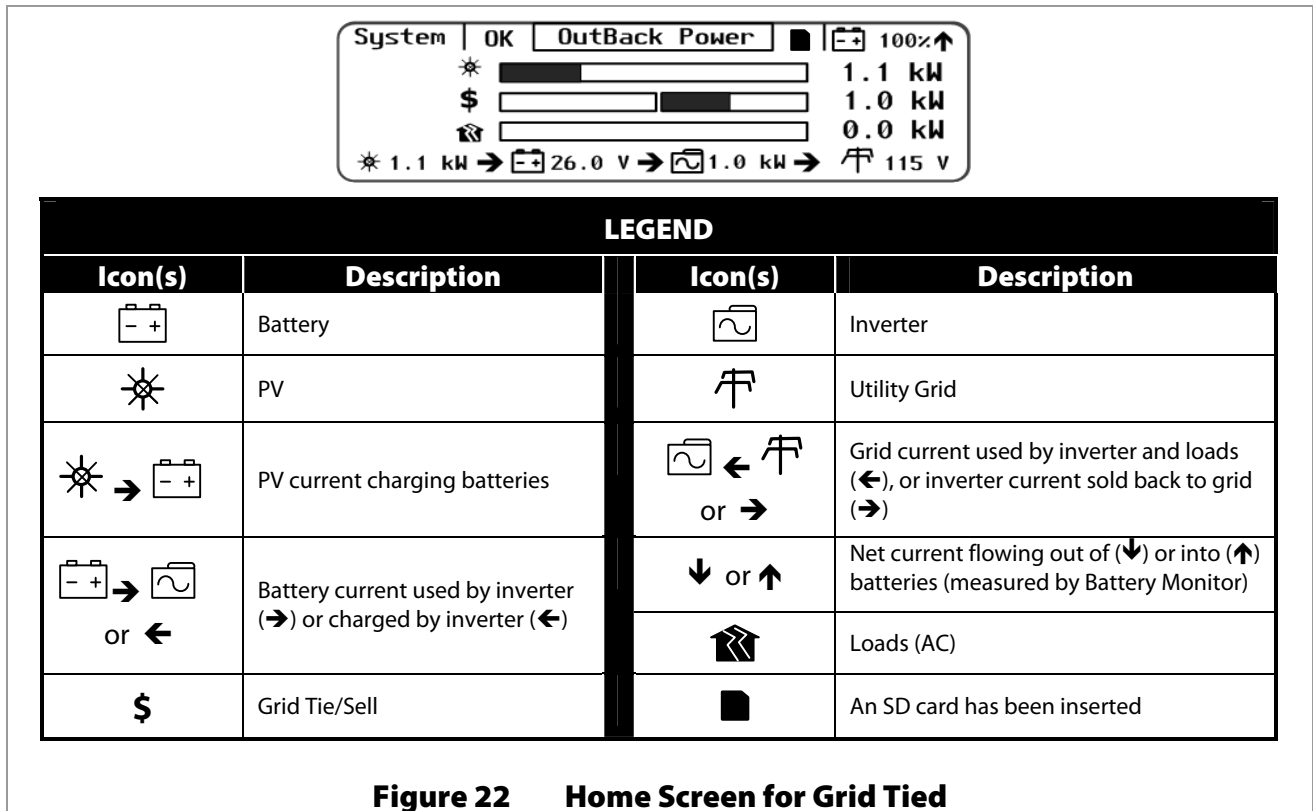

Figure 22 Home Screen for Grid Tied

NOTES:

	The utility grid symbol in the lower right corner of the screen marks a voltmeter that measures the AC voltage of the utility grid (or AC source).
	The inverter symbol on the bottom of the screen marks a kilowatt meter that measures the amount of power being used by the inverter from the generator (or AC source). This meter bar expands from left to right.
	The battery symbol on the bottom of the screen marks a voltmeter that measures the uncompensated battery voltage. (For a compensated voltage, see page 41.) The battery symbol in the top right corner of the screen marks a percentage meter that shows the SOC of the batteries as measured by the battery monitor. See page 112 for details. If no battery monitor is present, this figure will be replaced by another voltmeter.
	<p>The dollar symbol next to the bar actually marks two meter bars.</p> <ul style="list-style-type: none"> ➤ The meter on the right measures the amount of power sold back to the utility grid when grid-tied. This meter bar expands from left to right. ➤ The meter on the left measures the amount of power bought from the grid or AC source for charging or loads. This meter bar expands from right to left.
	The meter bar next to the house symbol measures power delivered to the inverter's output. This meter bar expands from left to right.
	The PV symbol in the lower left of the screen marks a kilowatt meter that measures the amount of PV power generated. The PV symbol next to the bar shows a graphic display of the PV power generated. This meter expands from left to right. If no charge controller is present on the HUB, neither of these symbols will be present.
OK	<p>This symbol indicates that no problems are noted with either the inverter, the utility grid, or the batteries.</p> <ul style="list-style-type: none"> ➤ If an inverter fault occurs, it will be replaced with the symbols (An event message will also appear.) ➤ If a grid problem occurs, it will be replaced with the symbols . (An event message will also appear.) ➤ If a battery monitor is present and registers a battery problem, it will be replaced by the symbols or . (An event message will also appear.) See pages 150 and 151 for information on these messages.

Backup Home Screen

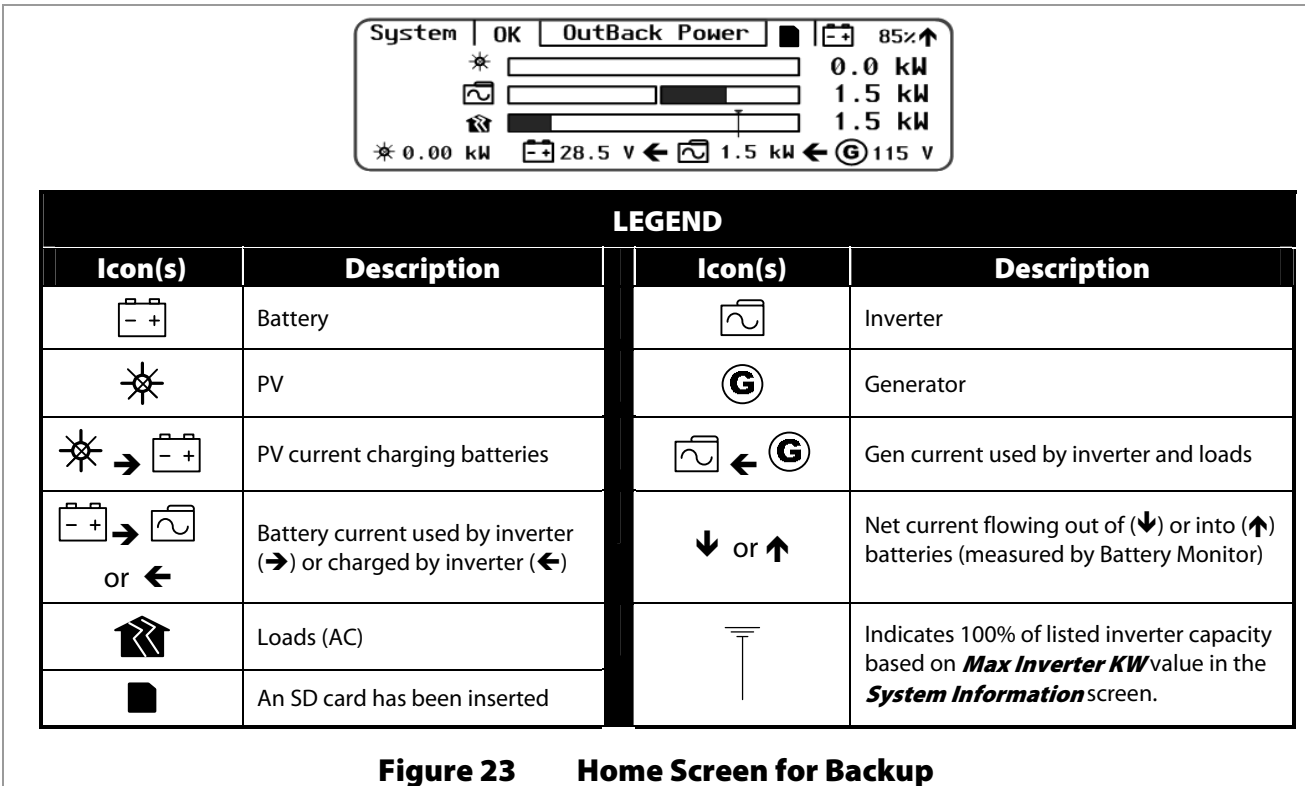

Figure 23 Home Screen for Backup





NOTES:

	The generator symbol in the lower right corner of the screen marks a voltmeter that measures the AC voltage of the generator (or AC source). This symbol only appears when the System Information menu (see page 74) shows an AC generator. The field is blank if no generator is selected and only utility grid is used.
	The inverter symbol on the bottom of the screen marks a kilowatt meter that measures the amount of power being used by the inverter from the generator (or AC source). The inverter symbol next to the center of the screen actually marks two meter bars. <ul style="list-style-type: none"> ➤ The meter on the left measures the amount of power taken out of the inverter when inverting or supporting loads. This meter bar expands from right to left. ➤ The meter on the right measures the amount of power taken into the inverter when charging. This meter bar expands from left to right.
	The battery symbol on the bottom of the screen marks a voltmeter that measures the uncompensated battery voltage. (For a compensated voltage, see page 41.) The battery symbol in the top right corner of the screen marks a percentage meter that shows the SOC of the batteries as measured by the battery monitor. See page 112 for details. If no battery monitor is present, this figure will be replaced by another voltmeter.
	The meter bar next to the house symbol measures power delivered to the inverter's output. This meter bar expands from left to right. The bar is scaled to 125% of the system's total inverting capacity and is used whether the inverter is in Invert or PassThru mode. The bar is marked at the 100% line to indicate when loads exceed the inverter capacity. If exceeded, this may be an indicator to reduce the loads.
	The PV symbol in the lower left of the screen marks a kilowatt meter that measures the amount of PV power generated. The PV symbol next to the bar shows a graphic display of the PV power generated. This meter expands from left to right. If no charge controller is present on the HUB, neither of these symbols will be present.
OK	This symbol indicates that no problems are noted with either the inverter, the utility grid, or the batteries. <ul style="list-style-type: none"> ➤ If an inverter fault occurs, it will be replaced with the symbols (An event message will also appear.) ➤ If a generator problem occurs, it will be replaced with the symbols . (An event message will also appear.) ➤ If a battery monitor is present and registers a battery problem, it will be replaced by the symbols or . (An event message will also appear.) See pages 150 and 151 for information on these messages.



Basic Navigation

Soft Keys

Four “soft” keys are located directly below the LCD. The functions of the soft keys will vary depending on the location of the user within the menu structure. Soft key functions are identified by icons or text directly above the key. Every soft key may not be used in some screens.

- The function of the far right soft key varies with the inverter model and system type (see pages 33 and 74). The following functions are true for all FX-class inverters.
 - ~ If the system type is **Off Grid**, then the soft key functions as an **Inverter Input Select** option. This soft key may not have a symbol above it. The  symbol will only be visible if a generator is present.
 - ~ If the system type is **Grid Tied**, the soft key functions as a **Grid Status** option. When **Grid Tied** is selected, the grid symbol  will be present.
 - ~ If the system type is **Backup**, the soft key is inoperative.
- For Radian inverters, the far right soft key functions as a **Grid Status** key (see page 39) regardless of which system type is selected. The grid symbol  will be present regardless of the input source.
- The right-center key, or **Inverter** soft key, displays information on any inverters present on the HUB. If no inverters are present (the  symbol is not present), this key is inoperative.

NOTE: The **Inverter** soft key is different from the **INVERTER** hot key (see page 55). The **Inverter** soft key has more information. However, it can only be accessed from the Home screen. The **INVERTER** hot key can control the inverting function. The **Inverter** soft key cannot.

- The left-center key, or **Battery** soft key, displays information on the battery bank and is marked with the symbol . The information available with the **Battery** soft key varies depending on whether the FLEXnet DC battery monitor is present on the HUB.
- The far left key, or **Charge Controller** soft key, displays information on any FLEXmax charge controllers present on the HUB. If no charge controllers are present, this key is inoperative and the  symbol is not present.

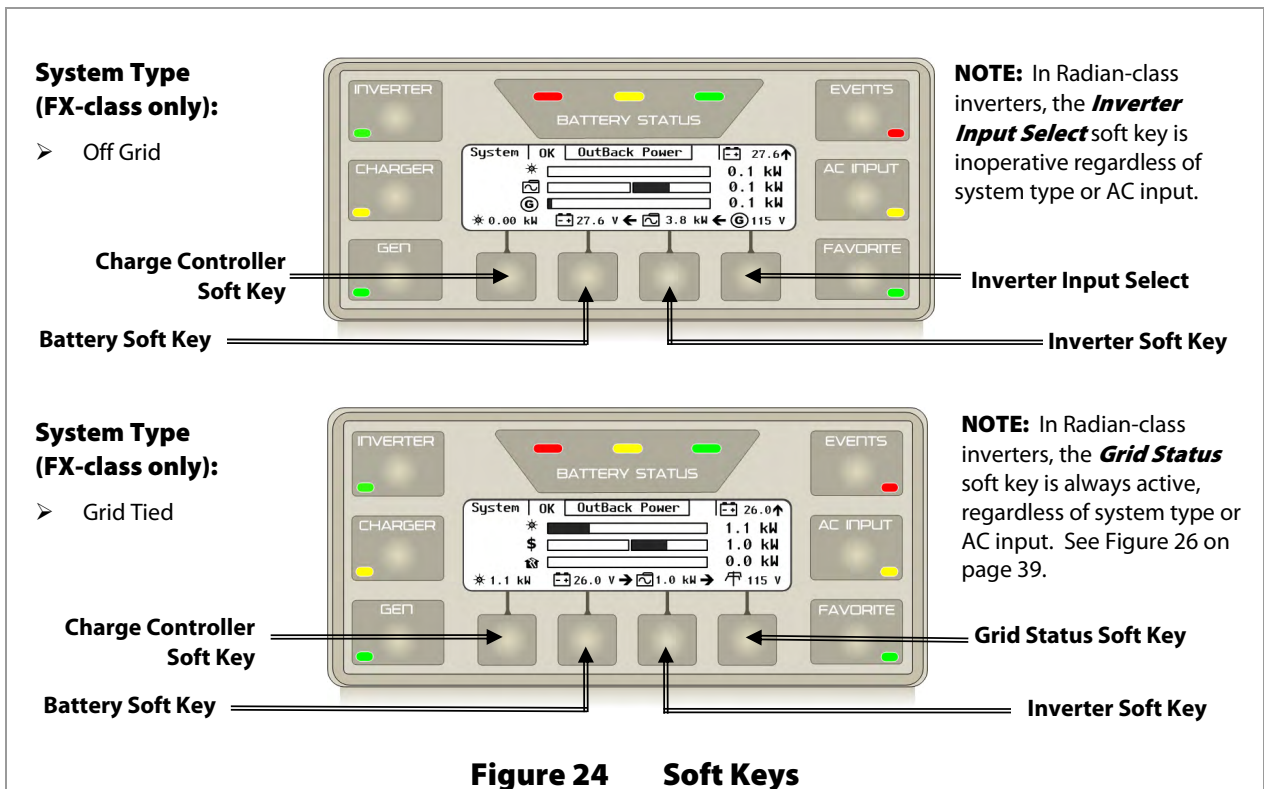

Inverter Input Select Soft Key (FX-class inverters only; Off Grid system type only)

Screen Items:
AC Input – Gen or Grid
Input Current Limit – *xx.x* to *xx.x* Aac*
(where xx = inverter-dependent.)

*See Caution below.

Soft Keys:
<Input> selects between the utility grid or a generator. Each set point has a pre-set value for the **Input Current Limit**.
If the pre-set values need to be changed, press the <Less> or <More> soft keys.
<Back> returns to the previous screen.

Figure 25 Inverter Input Select Soft Key Screen

This soft key is inoperative in Radian-class inverters. In the Radian, the functions accessed by this soft key are available in the **AC Input and Current Limit** menu (see page 83).



CAUTION: Equipment Damage

Ensure the input current limit does not exceed the rating of the overcurrent device or circuit breaker for the incoming current for the selected source.

Grid Soft Key

NOTE: In Radian inverters, the **Grid Status** soft key is always active, regardless of system type or AC input.

Not all screen items or messages will function if the inverter is not in the Grid Tied input mode.

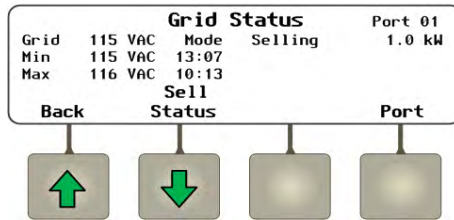
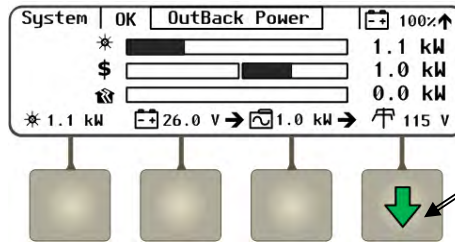

Soft Keys:

<Sell Status> brings up a group of messages indicating possible reasons for preventing the inverter to sell to the utility grid.

<Back> returns to the previous screen.

<Port> cycles through each device connected to the network.

Screen Items:

Grid displays the current AC voltage from the utility grid.

Min displays the lowest recorded AC voltage that day, and the time it was recorded.

Max displays the highest recorded AC voltage that day, and the time it was recorded.

Mode displays the inverter's current operating status (either buying or selling) and the number of kilowatts being bought or sold. This status will be blank if grid power is not present.

Figure 26 Grid Soft Key Screens

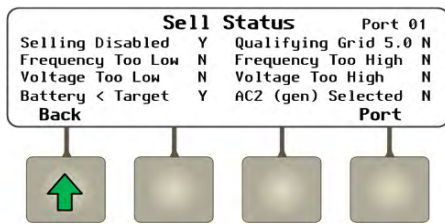

Soft Keys:

<Back> returns to the previous screen.

<Port> cycles through each device connected to the network.

Screen Items:

Selling Disabled: The **Grid-Tie Enable** command has been set to **N**(no). See page 91.

Qualifying Grid: The inverter is running a timed test during which it analyzes the grid quality. The timer is shown on the screen. (If the inverter is not a grid-interactive model, a random number may be displayed.)

Frequency Too Low/Too High, Voltage Too Low/Too High: The frequency or voltage are outside the acceptable limits for that model of inverter.

Battery < Target: The battery voltage is below the target voltage for that stage (X = Float, SellRE, etc). No excess energy is available to sell. See Figure 29 on page 41 for a description of target voltages.

AC2 (gen) Selected: The **Input Type** command has been set to **Gen**. The inverter will not sell to a source that it identifies as a generator. See page 83.

NOTE: This menu item is not present in Radian-class inverters.

See the inverter *Operator's Manual* for the operating details, specifications, and modes relating to all the screen items shown here.

Figure 27 Sell Status Screen

Inverter Soft Key

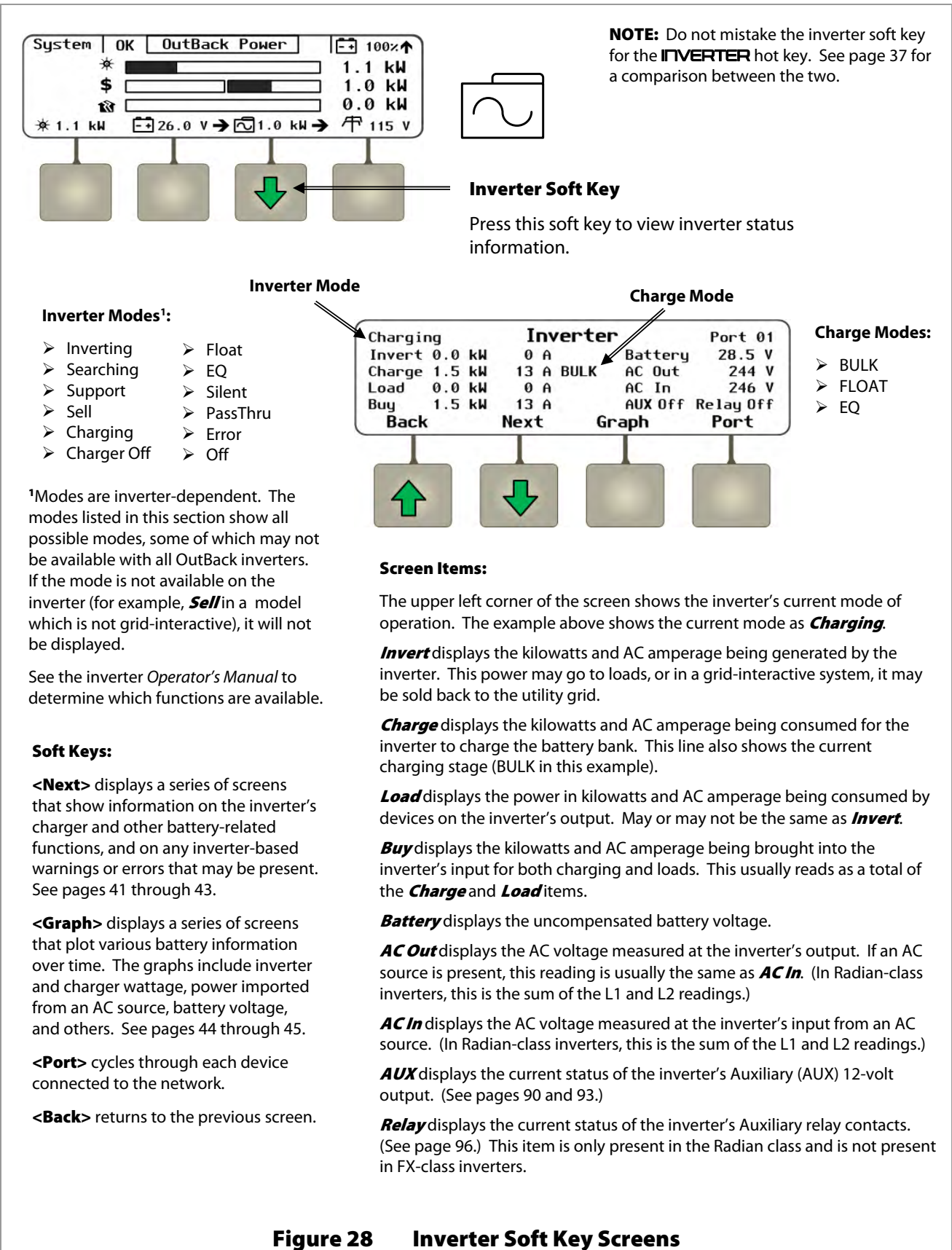

Figure 28 Inverter Soft Key Screens

From the *Inverter* screen, the <Next> soft key brings up several possible screens.

Diode Charging

Charging		← Inverter		Port 01
Invert	0.0 kW	0 A	Battery	28.5 V
Charge	1.5 kW	13 A BULK	AC Out	244 V
Load	0.0 kW	0 A	AC In	246 V
Buy	1.5 kW	13 A	AUX Off	Relay Off
Back	Next	Graph	Port	

L1 Phase Screen (Radian only)

Charging		← L1 Phase		Port 01
Invert	0.0 kW	0 A	Battery	28.5 V
Charge	1.5 kW	13 A BULK	AC Out	120 V
Load	0.0 kW	0 A	AC In	122 V
Buy	1.5 kW	13 A	AUX Off	Relay Off
Back	Next	Graph	Port	

NOTE: The *L1 Phase* and *L2 Phase* screens are only present in the Radian class. The screen items are the same as those listed on page 40, but the AC voltage readings are those of the individual L1 and L2 phases. These screens are not present in FX-class inverters. The next screen is *Inverter Battery*.

In any of these screens, a diode symbol may appear to the left of the screen name to indicate “diode charging” mode. This is a low-power mode that allows fine control of charging, selling, and load support. (See the *Operator’s Manual* for information.)

L2 Phase Screen (Radian only)

Charging		← L2 Phase		Port 01
Invert	0.0 kW	0 A	Battery	28.5 V
Charge	1.5 kW	13 A BULK	AC Out	124 V
Load	0.0 kW	0 A	AC In	124 V
Buy	1.5 kW	13 A	AUX Off	Relay Off
Back	Next	Graph	Port	

Actual		Inverter Battery		Port 01
Absorb	28.5 V	Temp Comp	Battery	28.5 V
Float	29.2 V	Batt Temp		25 C
Equalize	26.8 V	Re-Float		25.0 V
Back	Warn	Error	Port	

Screen Items:

Actual displays the uncompensated battery voltage.

Absorb displays the Absorption voltage setting which was programmed into the inverter’s charger. During the bulk and absorption stages, this is the target voltage used by the charger.

Float displays the Float voltage setting which was programmed into the inverter’s charger. During the float stage, this is the target voltage used by the charger.

Equalize displays the Equalization voltage setting which was programmed into the inverter’s charger. During the equalization charging cycle, this is the target voltage used by the charger.

Temp Comp displays the corrected battery voltage after temperature readings are taken into account from the Remote Temperature Sensor (RTS). If no RTS is present, **Temp Comp** and **Actual** will read the same.

Batt Temp displays the battery temperature in degrees Celsius, as measured by the RTS. This reading is only valid for port 1 on the HUB. If other ports are selected, or if no RTS is present, the characters ### will be displayed.

Re-Float displays the Re-Float setting which was programmed into the inverter’s charger. This is the voltage used for the inverter to return from Silent mode to the float stage.

Sell RE voltage is the target voltage for the inverter to switch to Sell Mode. (Grid-interactive systems only)

Soft Keys:

<Warn> displays a series of screens with a list of non-critical inverter faults and other information. These screens are shown beginning on page 42.

<Error> displays a screen with a list of critical inverter faults. These screens are shown beginning on page 43.

<Back> returns to the previous screen.

<Port> cycles through each device connected to the network.

Actual		Inverter Battery		Port 01
Absorb	28.5 V	Temp Comp	Battery	28.5 V
Float	29.2 V	Batt Temp		25 C
Equalize	26.8 V	Re-Float		25.0 V
Back	Warn	Error	Port	

Actual		Inverter Battery		Port 01
Absorb	28.5 V	Temp Comp	Battery	28.5 V
Float	29.2 V	Batt Temp		25 C
Equalize	26.8 V	Re-Float		25.0 V
Back	Warn	Error	Sell RE	26.0 V

NOTE: If an arrow appears next to the items **Absorb**, **Float**, or **Equalize**, it indicates the charger is in that stage. The arrow will not appear if the charger is in the bulk stage or Silent mode.

NOTE: In grid-interactive systems, the **Sell RE** voltage will be included.

Figure 29 Inverter Battery Screen

Warning Messages

A Warning message is caused by a noncritical inverter fault. When this occurs, the inverter will not shut down, but will display a fault LED. One or more messages in this menu will change from **N** to **Y**. A warning is also accompanied by an event message (see page 61).

Some warnings can become errors if left unattended. Frequency and voltage warnings are meant to warn of a problematic AC source. See the inverter *Operator's Manual* for more information on troubleshooting a specific warning.

	Inverter Battery		Port 01
Actual	28.5 V	Temp Comp	28.5 V
Absorb	29.2 V	Batt Temp	25 C
Float	26.8 V	Re-Float	25.0 V
Equalize	31.0 V		
Back	Warn	Error	Port



	Inverter Warnings		Port 01
AC Freq Too High	N	AC Freq Too Low	N
Voltage Too High	N	Voltage Too Low	N
Input Amps > Max	N	Temp Sensor Bad	N
Comm Error	N	Fan Failure	N
Back	Temps	IEEE	Port



Screen Items:

AC Freq Too High: The AC source is above the acceptable frequency limit and prevents connection.

AC Freq Too Low: The AC source is below the acceptable frequency limit and prevents connection.

Voltage Too High: The AC source is above the upper acceptable voltage limit and prevents connection.

Voltage Too Low: The AC source is below the lower acceptable voltage limit and prevents connection.

Input Amps > Max: AC loads are drawing more current from the AC source than allowed by the input setting.

Temp Sensor Bad: An internal inverter temperature sensor may be malfunctioning. This is indicated by an unusual **Transformer, Output FETs, or Capacitors** reading.

Comm Fault: Probable failure on inverter's control board which has interrupted internal communications.

Fan Failure: The inverter's internal cooling fan is not operating properly. Lack of cooling may result in derated output wattage.

Soft Keys:

<Temps> displays the **Inverter Temps** screen, with the readings for the inverter's internal temperature sensors. One sensor is attached to the main transformer, another is on the heat sink for the Field Effect Transistors (FETs), and one is on the filter capacitors. Normally all three sensors read approximately the same. An unusually high or unusually low reading on one sensor indicates a defective sensor. Contact OutBack Technical Support if necessary (see inside front cover of this manual).

The screen is different for Radian-class inverters. Radian inverters consist of twin power modules (right and left) with independent sensors and readings for each module.

<IEEE> displays the **IEEE Warnings** screen, with reasons why the inverter might stop selling power, and **Y** or **N** status messages. This item and screen are only available in the Radian-class inverters and are not visible in FX-class inverters.

NOTE: These messages, **AC Freq Too High, AC Freq Too Low, Voltage Too High, and Voltage Too Low**, have the same names as those shown on page 62. However, these items do not have the same function. They are only active in the Radian-class inverter's Grid Tied input mode. They only indicate whether the inverter sells power, not whether it disconnects. (See the Radian *Operator's Manual* for limits on selling.)

<Back> returns to the previous screen.

Inverter Temps Screen (FX-class)

	Inverter Temps		Port 01
Transformer	30 C		
Output FETs	31 C		
Capacitors	31 C		
Back			Port

Inverter Temps Screen (Radian-class)

	Inverter Temps		Port 01
	Left	Right	
Transformer	30 C	30 C	
Output FETs	31 C	31 C	
Capacitors	31 C	31 C	
Back			Port

IEEE Warnings Screen (Radian-class)

	IEEE Warnings		Port 01
AC Freq Too High	N	AC Freq Too Low	N
Voltage Too High	N	Voltage Too Low	N
Back			Port

Figure 30 Inverter Warnings and Temperatures

Error Messages

An Error message is caused by a critical inverter fault. When this occurs, the inverter will usually shut down and will display a fault LED. One or more messages in this menu will change from **N** to **Y**. An error is also accompanied by an event message (see page 61).

See the inverter *Operator's Manual* for more information on troubleshooting a specific error.

Inverter Battery				Port 01
Actual	28.5 V	Temp Comp	28.5 V	
Absorb	29.2 V	Batt Temp	25 C	
Float	26.8 V	Re-Float	25.0 V	
Equalize	31.0 V			
Back	Warn	Error	Port	

↑

□

↓

□

Inverter Errors				Port 01
Low Output Voltage	N	Low Battery	V	N
AC Output Shorted	N	High Battery	V	N
AC Output Backfeed	N	Over Temperature	N	N
Stacking Error	N	Phase Loss	N	N
Back			Port	

↑

□

□

□

Soft Keys:

<Back> returns to the previous screen.

<Port> cycles through each device connected to the network.

Screen Items:

Low Output Voltage: The inverter's AC regulation cannot be maintained under high load conditions.

AC Output Shorted: The inverter exceeded its maximum surge current due to severe overload.

AC Output Backfeed: Usually indicates another AC power source (out of phase with the inverter) was connected to the unit's AC output.

Stacking Error: A programming problem among stacked units. (Often occurs if there is no master.)

Low Battery V: The DC voltage is below the Low Battery Cut-Out (LBCO) set point. (See page 88.)

High Battery V: The DC voltage is above the inverter's acceptable level (as specified in the *Operator's Manual* for the appropriate inverter).

Over Temperature: The inverter has exceeded its maximum allowed operating temperature.

Phase Loss: A slave was ordered to transfer to AC by the master, but no AC is present. The unit continues inverting. This is the only "Error" that is not accompanied by a shutdown.

Figure 31 Inverter Errors

Operation

From the **Inverter** screen (see Figure 23 on page 40), the **<Graph>** soft key brings up the following screens which plot various type of data over time. The first screen shows changes in wattage produced by the inverter over time.

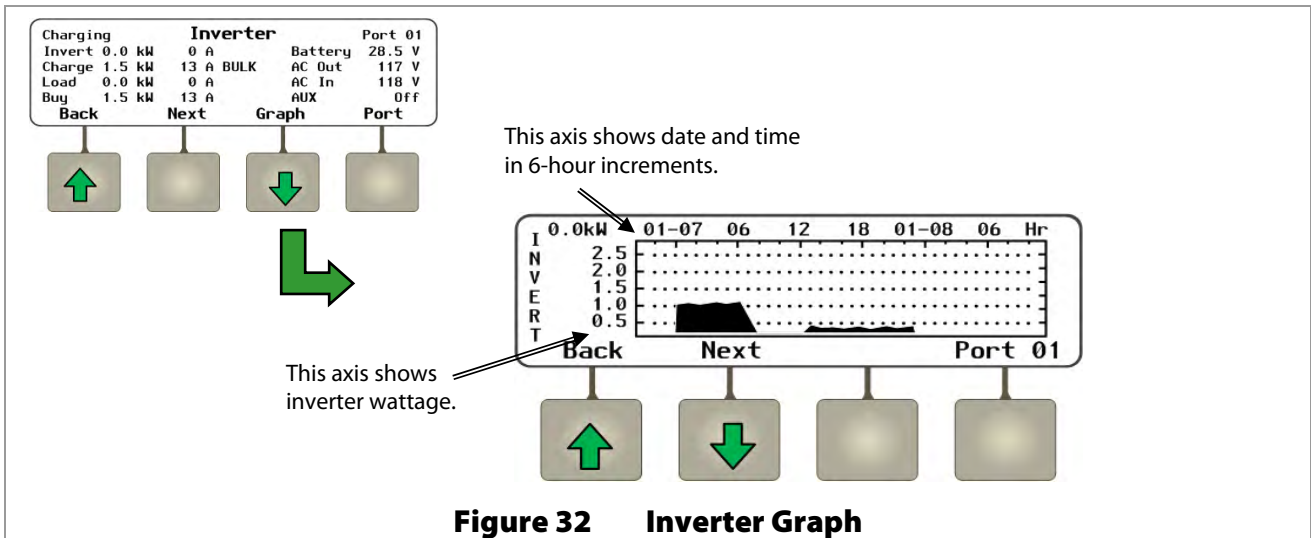

The **<Next>** soft key brings up a screen which shows changes in wattage produced by the battery charger over time.

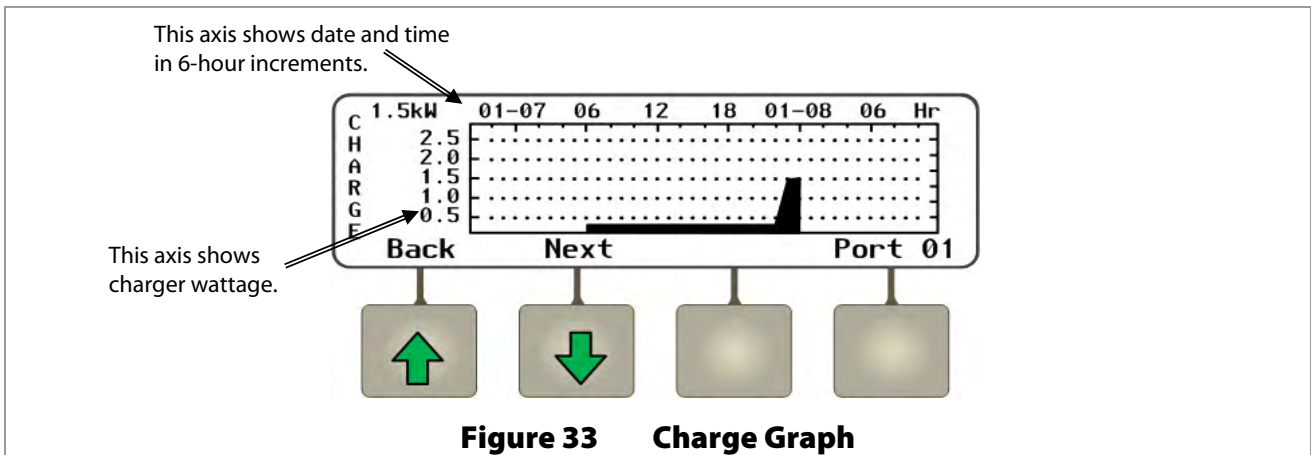

The **<Next>** soft key brings up a screen which shows changes in wattage imported (bought) by the inverter system from an AC source over time.

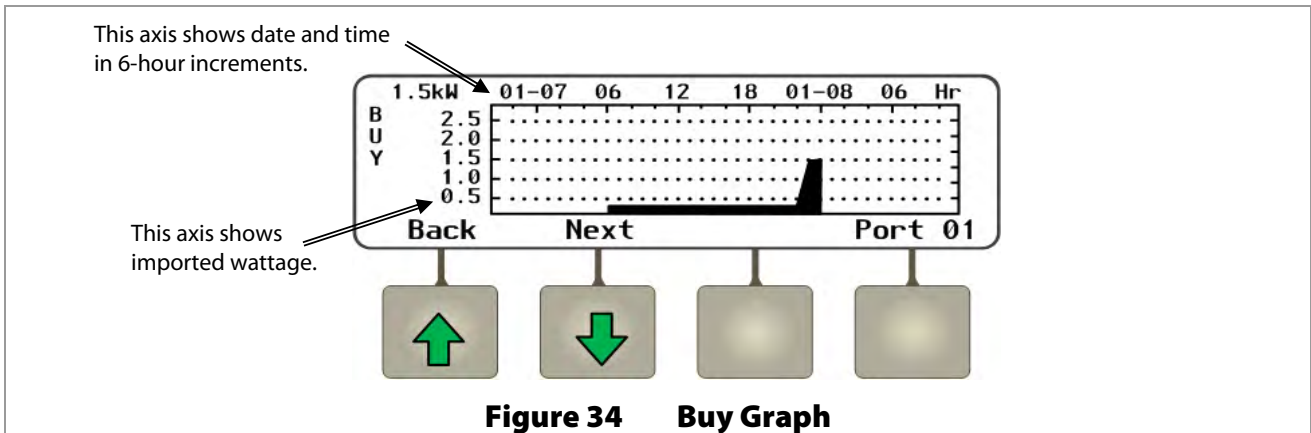

The **<Next>** soft key brings up a screen which shows changes in wattage sold to the utility by a grid-interactive system over time.

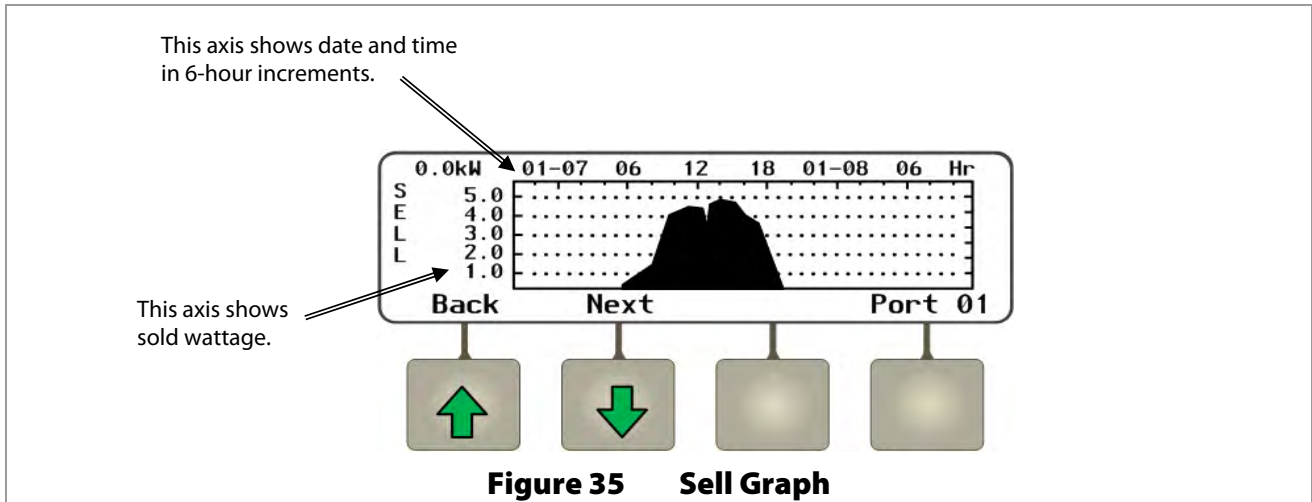

The **<Next>** soft key brings up a graph showing changes in battery voltage over time. This graph may be used by other soft keys.

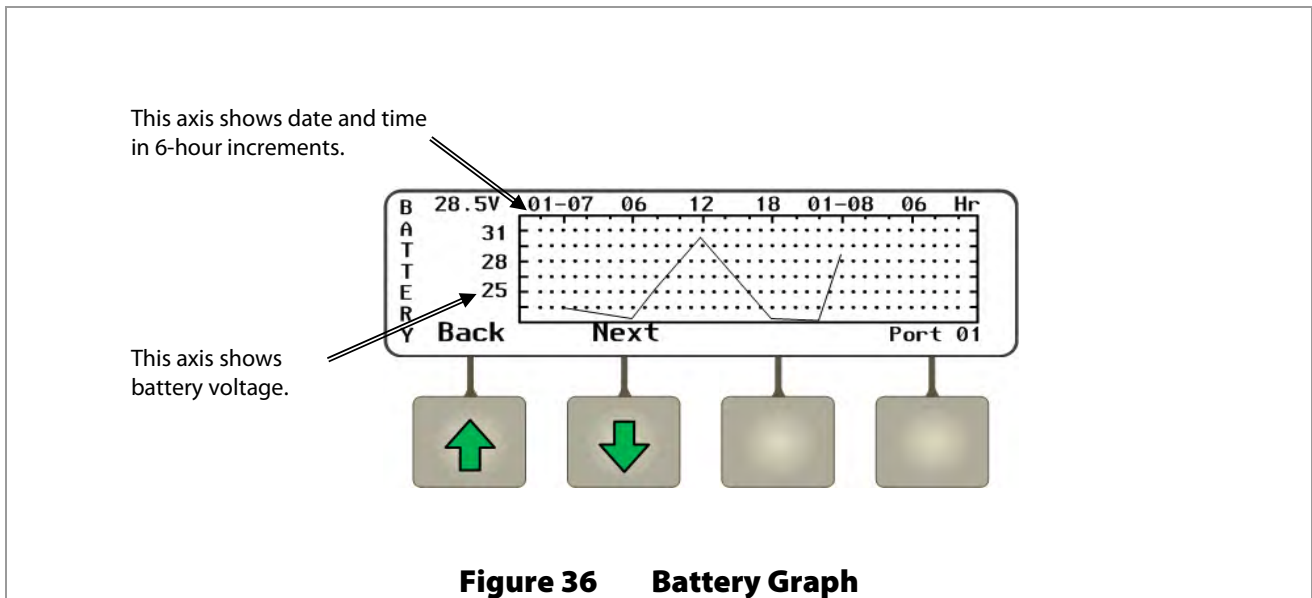

Continuing to press the **<Next>** soft key will proceed through the same graphs again from the beginning.

Battery Soft Key

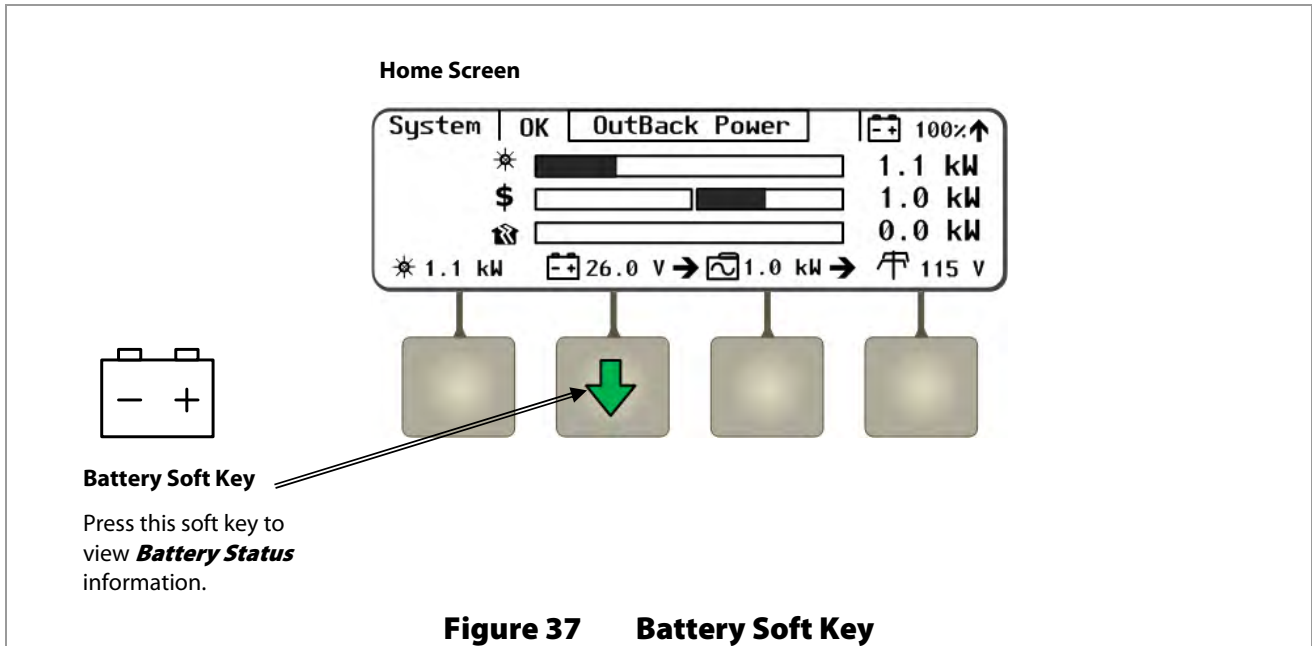

Figure 37 Battery Soft Key

If no FLEXnet DC battery monitor is present on the system, the battery soft key brings up the following screens.

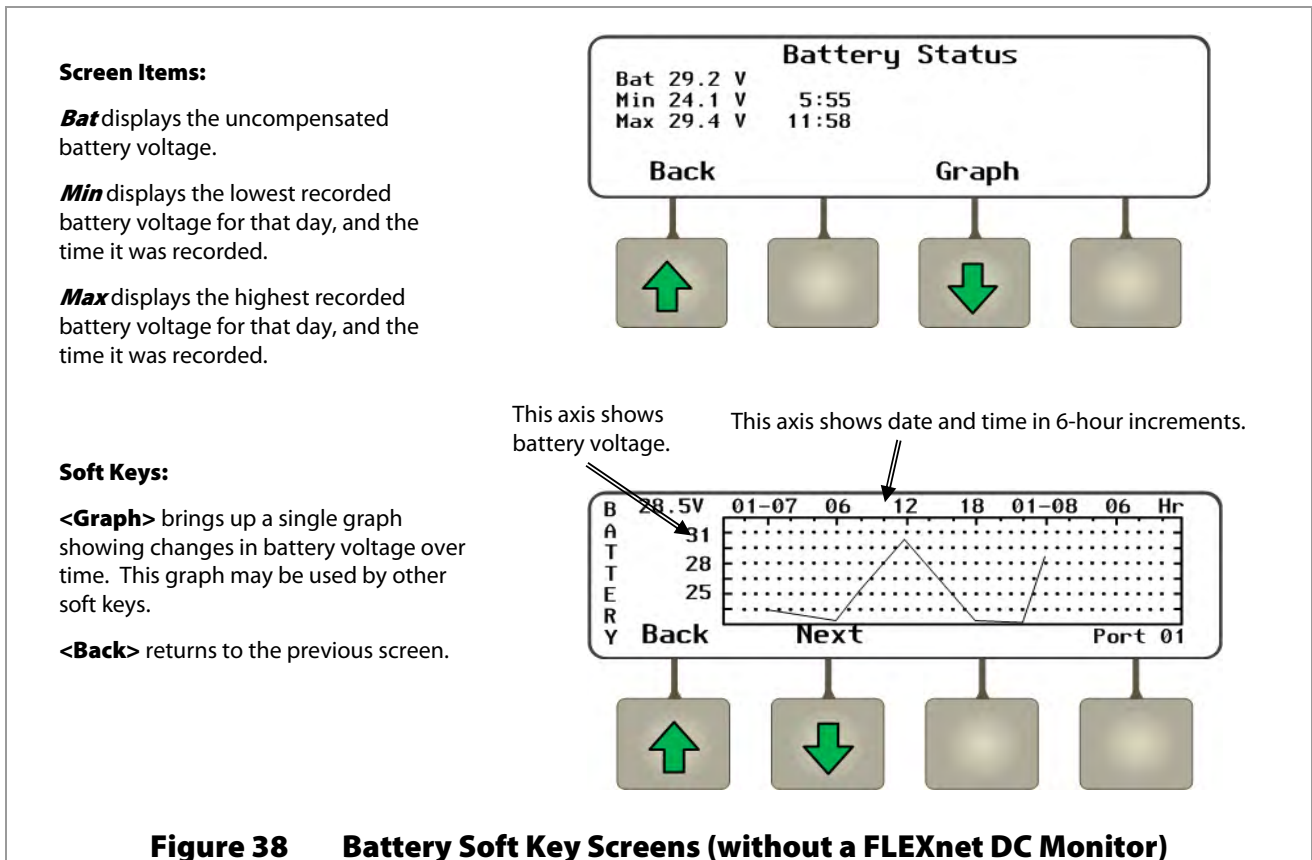
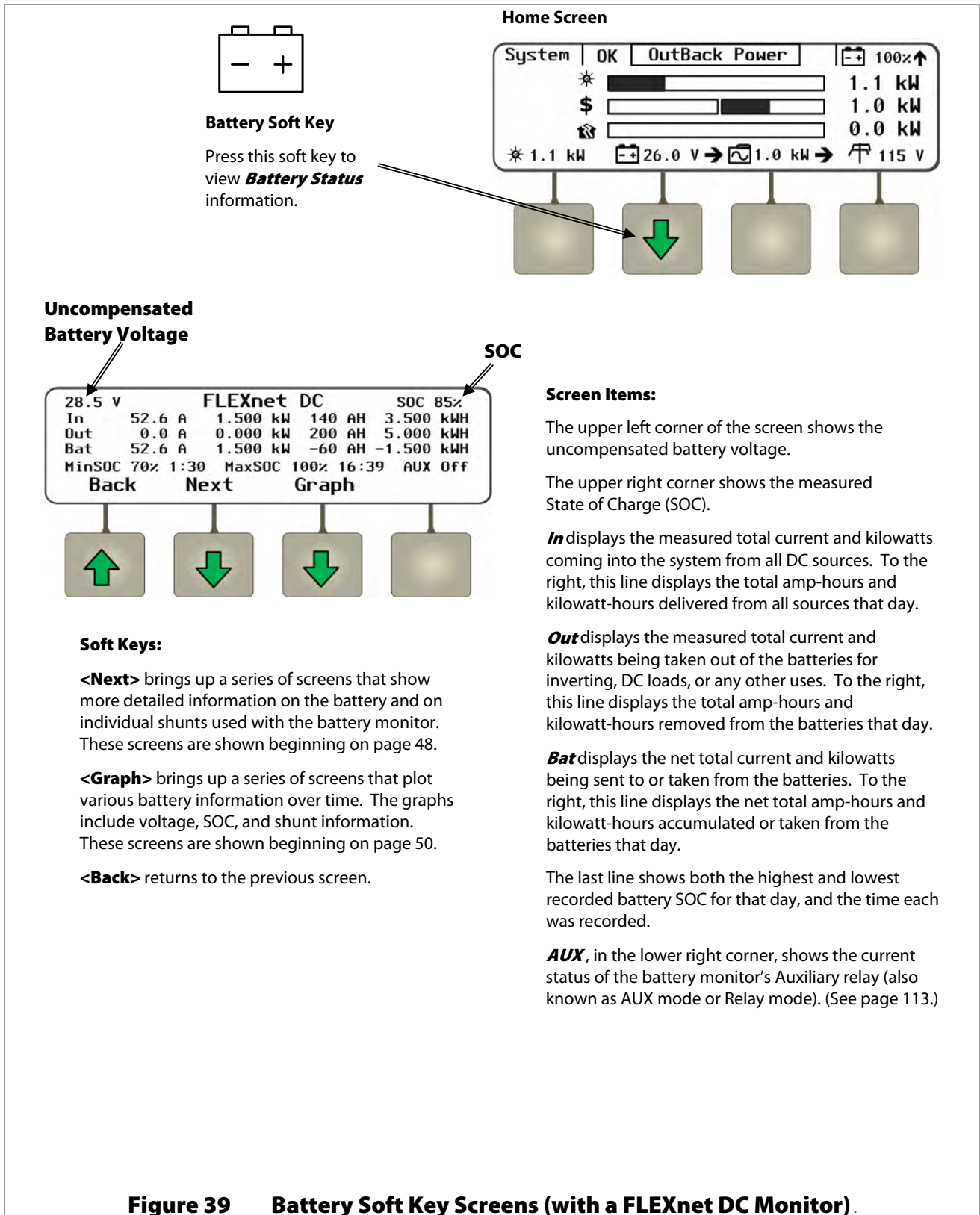

Figure 38 Battery Soft Key Screens (without a FLEXnet DC Monitor)

If a FLEXnet DC battery monitor is present on the system, the **Battery** soft key brings up the following screens.



Operation

From the **FLEXnet DC** screen, the **<Next>** soft key brings up the following screens.

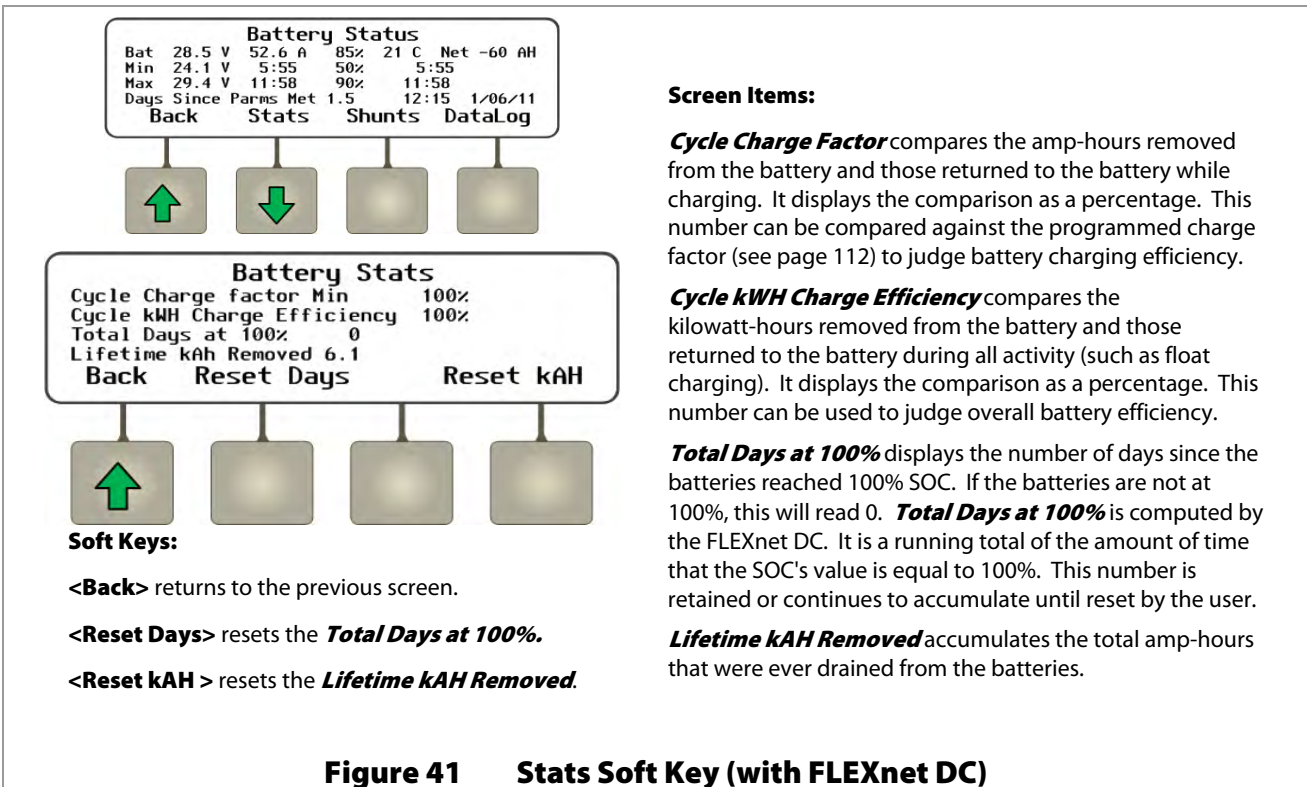
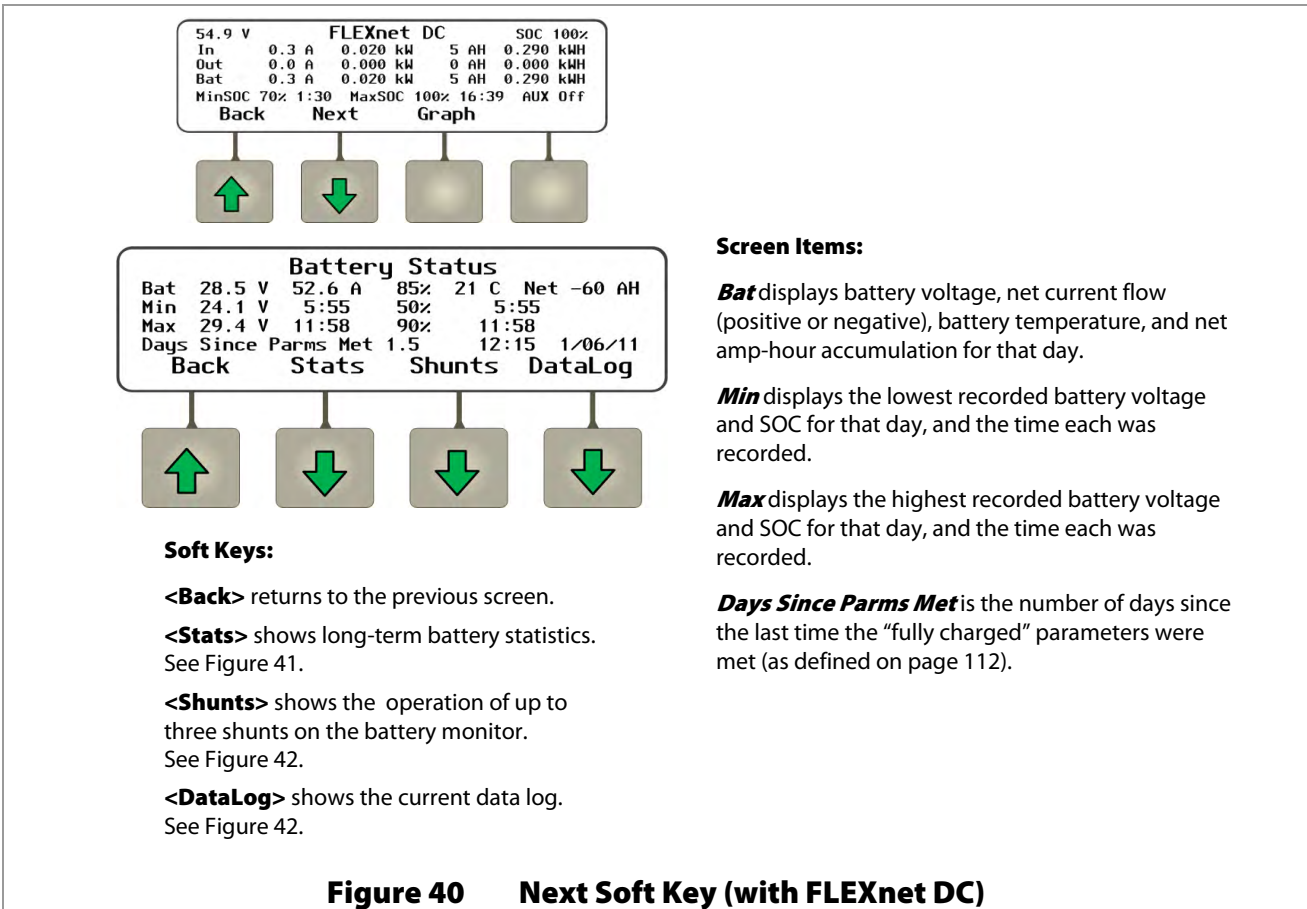

The <Shunts> soft key shows the operation of up to three shunts on the battery monitor. If a shunt has not been enabled (see page 112), it will read 0.

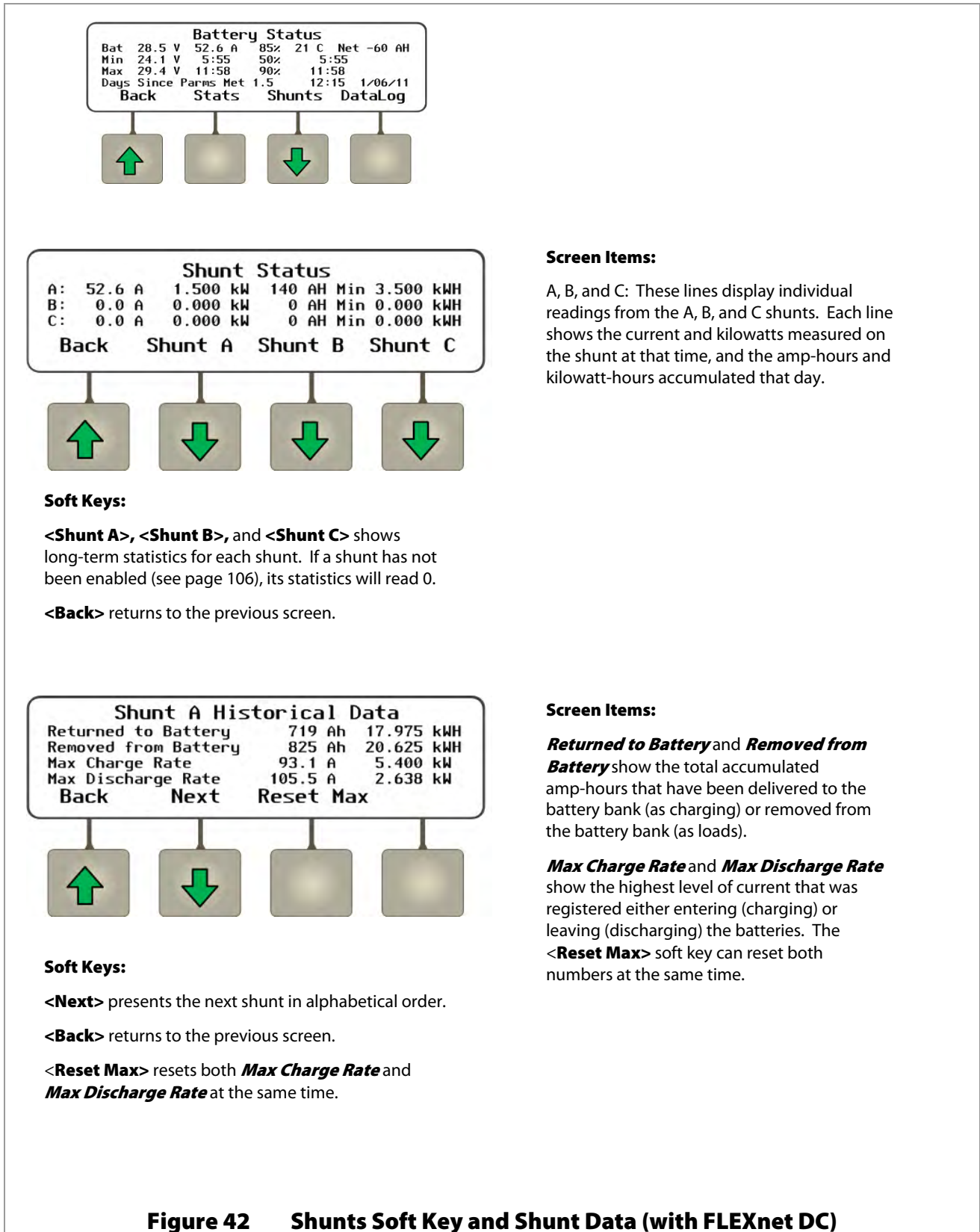

Screen Items:

A, B, and C: These lines display individual readings from the A, B, and C shunts. Each line shows the current and kilowatts measured on the shunt at that time, and the amp-hours and kilowatt-hours accumulated that day.

Soft Keys:

<Shunt A>, <Shunt B>, and <Shunt C> shows long-term statistics for each shunt. If a shunt has not been enabled (see page 106), its statistics will read 0.

<Back> returns to the previous screen.

Screen Items:

Returned to Battery and **Removed from Battery** show the total accumulated amp-hours that have been delivered to the battery bank (as charging) or removed from the battery bank (as loads).

Max Charge Rate and **Max Discharge Rate** show the highest level of current that was registered either entering (charging) or leaving (discharging) the batteries. The <Reset Max> soft key can reset both numbers at the same time.

Soft Keys:

<Next> presents the next shunt in alphabetical order.

<Back> returns to the previous screen.

<Reset Max> resets both **Max Charge Rate** and **Max Discharge Rate** at the same time.

Figure 42 Shunts Soft Key and Shunt Data (with FLEXnet DC)

Operation

The **<DataLog>** soft key shows amp-hour, watt-hour, and SOC statistics. These maintain a continuous daily log, up to 128 days, which can be recalled. One day can be displayed at a time.

The diagram illustrates the navigation between two screens. The top screen, titled "Battery Status", displays the following data:

Bat	28.5 V	52.6 A	85%	21 C	Net -60 AH
Min	24.1 V	5:55	50%	5:55	
Max	29.4 V	11:58	90%	11:58	
Days Since	Parms Met	1.5	12:15	1/06/11	

Navigation options below the top screen: **Back** (green up arrow), **Stats**, **Shunts**, and **DataLog** (green down arrow).

The bottom screen, titled "FLEXnet DC DataLog", displays the following data:

Today		Minimum SOC	50%
Input	140 Ah	3.500 kWh	
Output	200 Ah	5.000 kWh	
Net	-60 Ah	-1.500 kWh	

Navigation options below the bottom screen: **Back** (green up arrow), **+Day**, **-Day**, and **-Day**.

Screen Items:

- Today** (in this example) indicates the date of the data log screen. The current day will read **Today**. Pressing the **<-Day>** soft key will show the data log for the previous day and **Today** will become a date.
- Minimum SOC** shows the lowest battery state of charge (SOC) for that day.
- Input** shows the number of amp-hours and kilowatt-hours brought into the batteries that day.
- Output** shows the number of amp-hours and kilowatt-hours removed from the batteries that day.
- Net** shows the net gain or loss in amp-hours or kilowatt-hours that day. This is the difference between the **Input** and **Output** fields.

Soft Keys:

- <+Day>** advances the display forward by a single day. If the display reads **Today**, it does nothing.
- <-Day>** moves the display backward by a single day and will display the selected date.
- <Back>** returns to the previous screen.

Figure 43 DataLog Soft Key Screen (with FLEXnet DC)

From the **FLEXnet DC** screen, the **<Graph>** soft key brings up the following screens which plot various type of data over time. The first screen shows changes in battery voltage over time.

The diagram shows the "Graph Soft Key (with FLEXnet DC)" screen with the following data:

28.5 V	FLEXnet DC			SOC 85%
In	52.6 A	1.500 kW	140 AH	3.500 kWh
Out	0.0 A	0.000 kW	200 AH	5.000 kWh
Bat	52.6 A	1.500 kW	-60 AH	-1.500 kWh
MinSOC	70%	1:30	MaxSOC	100% 16:39 AUX Off

Navigation options below the screen: **Back** (green up arrow), **Next**, **Graph** (green down arrow), and an unlabeled soft key.

Figure 44 Graph Soft Key (with FLEXnet DC)

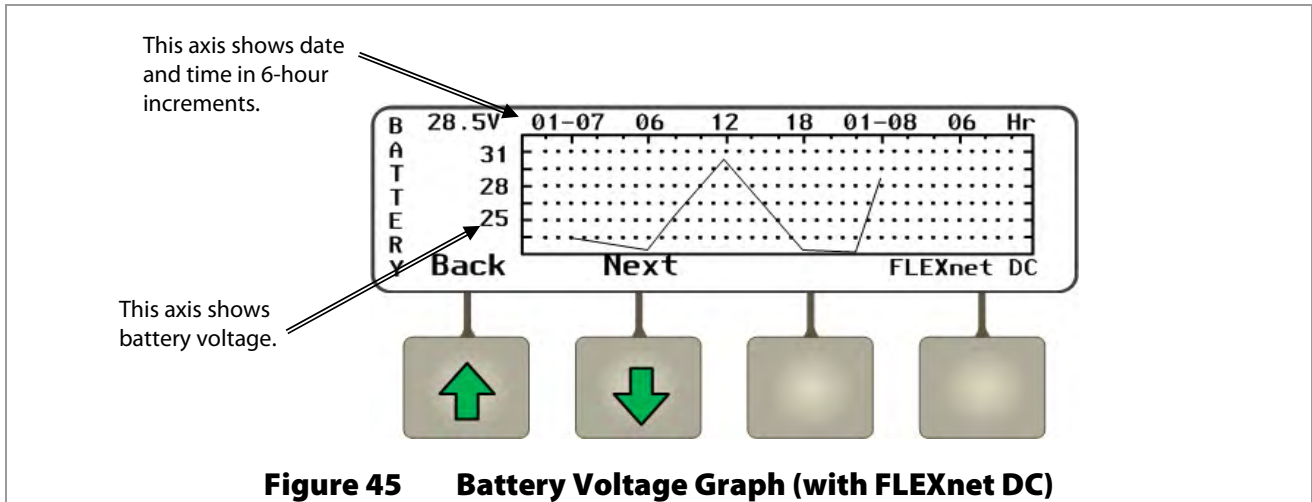

The **<Next>** soft key brings up a screen which shows changes in SOC over time.

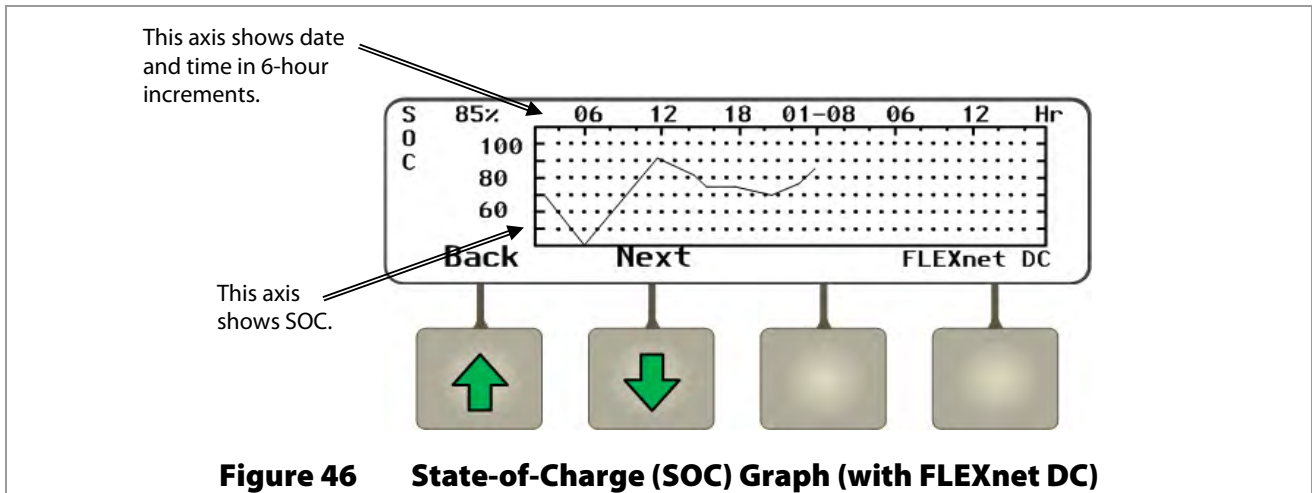

The **<Next>** soft key brings up a screen which shows changes in wattage over time for the first shunt, Shunt A.

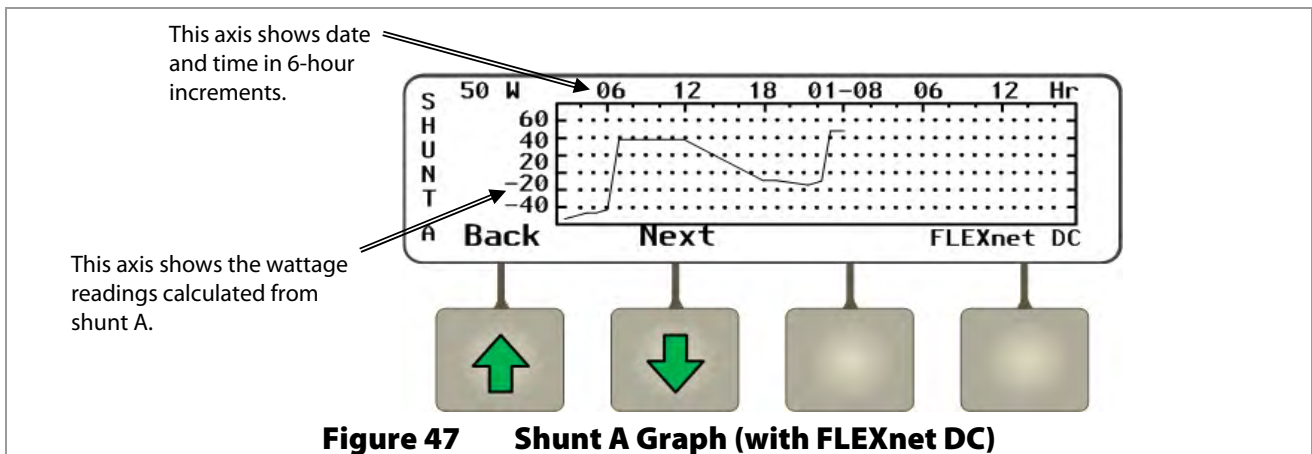

Continuing to press the **<Next>** soft key will proceed to Shunts B and C if they have been enabled. If Shunts B or C are not enabled, the **<Next>** soft key will return to the Battery graph.

Charge Controller Soft Key

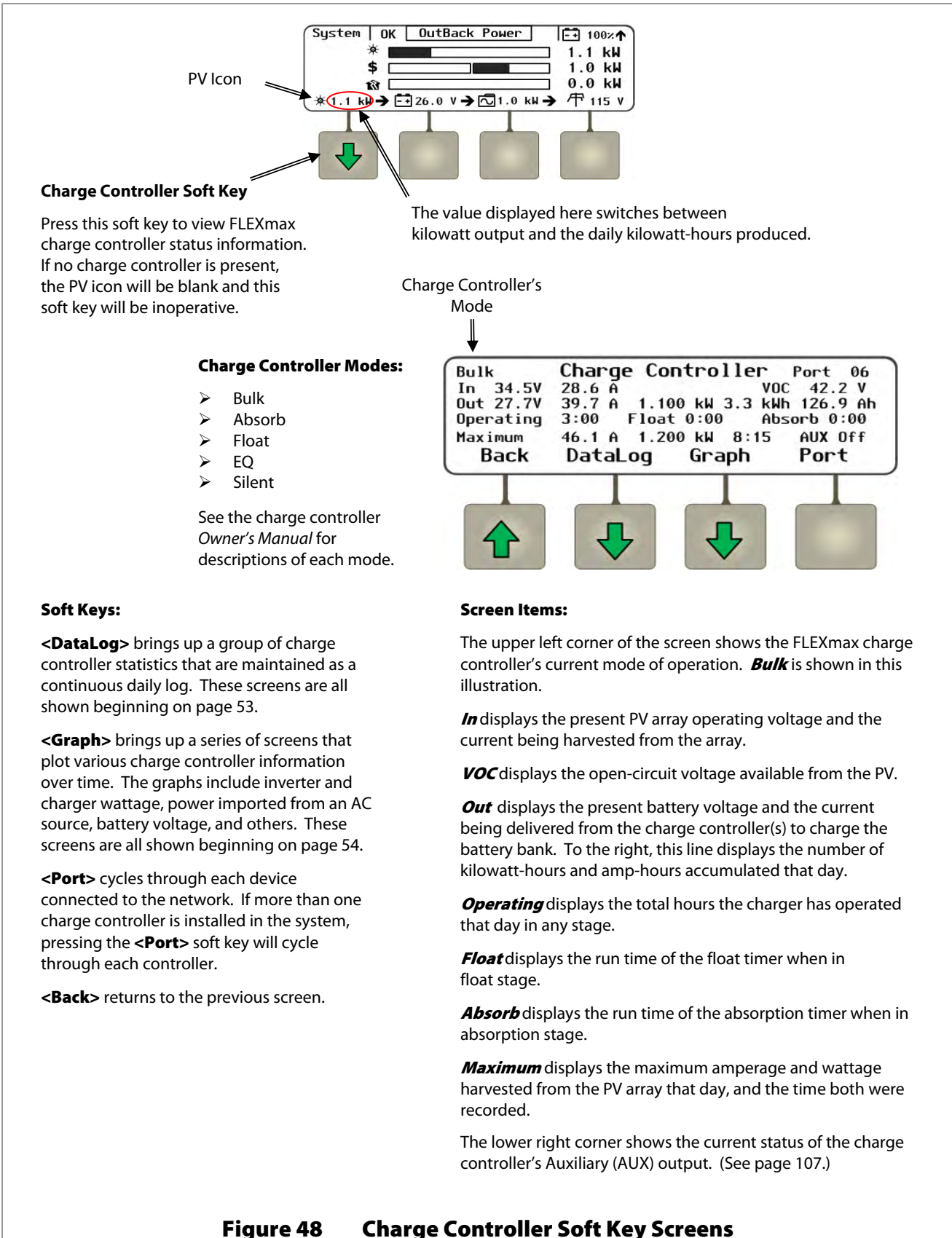
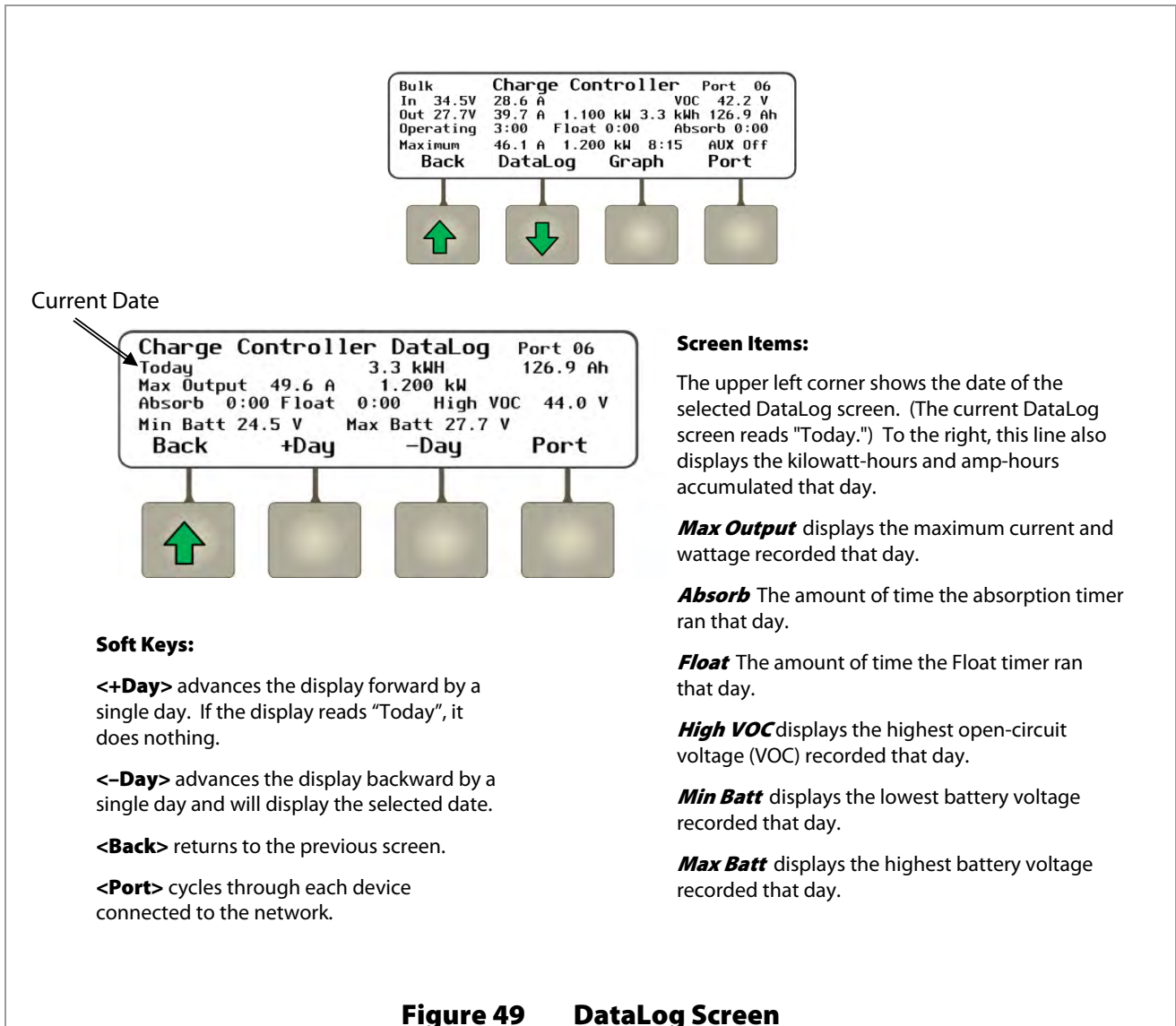

Figure 48 Charge Controller Soft Key Screens

DataLog Screen

The <DataLog> soft key shows accumulated daily amp-hour and watt-hour statistics, as well as maximum current, wattage, and maximum and minimum voltage figures. These maintain a continuous daily log, up to 128 days, which can be recalled. One day can be displayed at a time.



Operation

Graph Screens

The **<Graph>** soft key brings up the following screens which plot various type of data over time. The first screen shows changes in PV wattage over time.

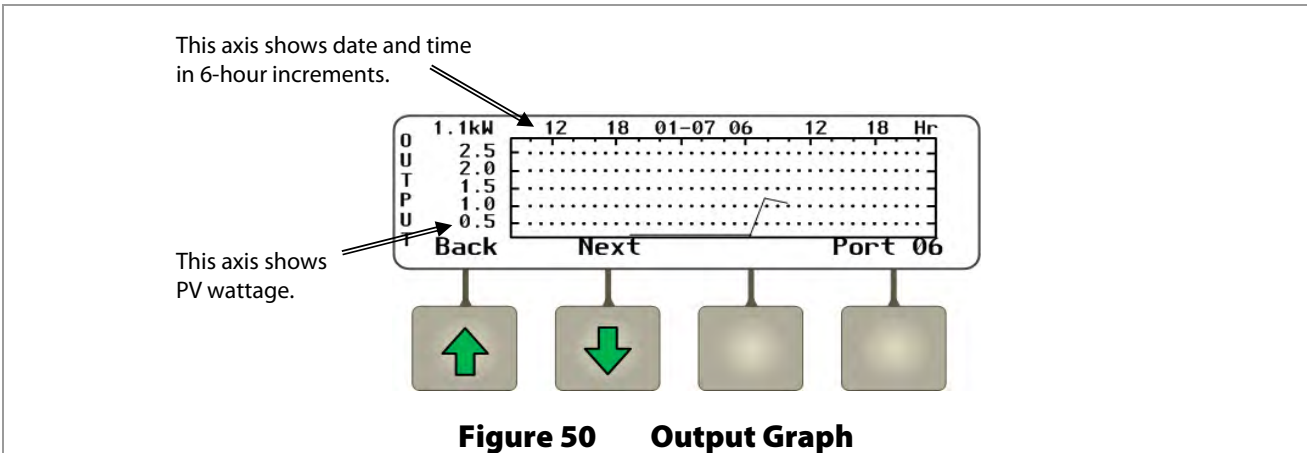

The **<Next>** soft key brings up a screen showing changes in battery voltage over time. This graph may be used by other soft keys.

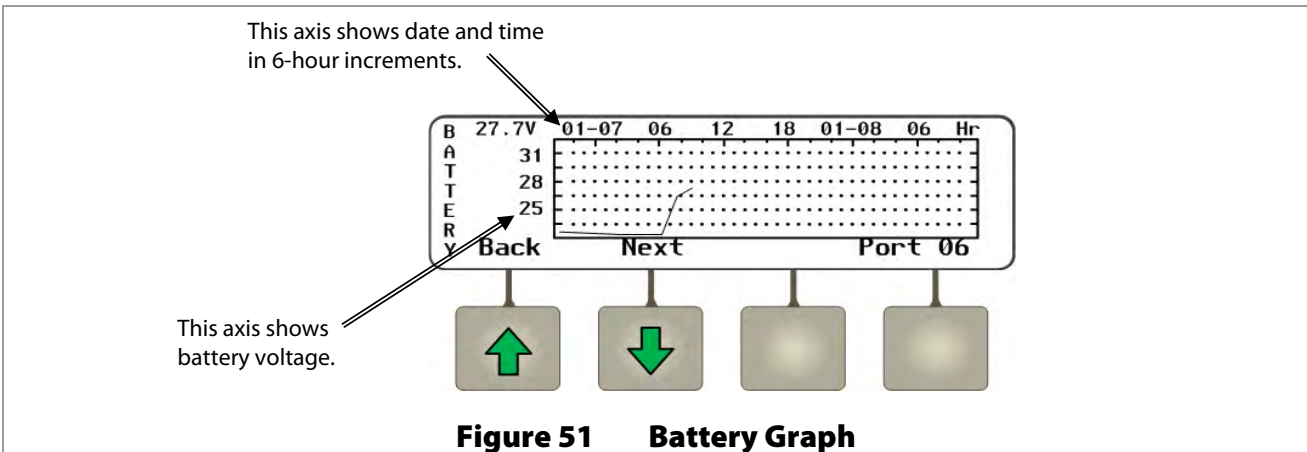

The **<Next>** soft key brings up a screen showing changes in PV voltage over time.

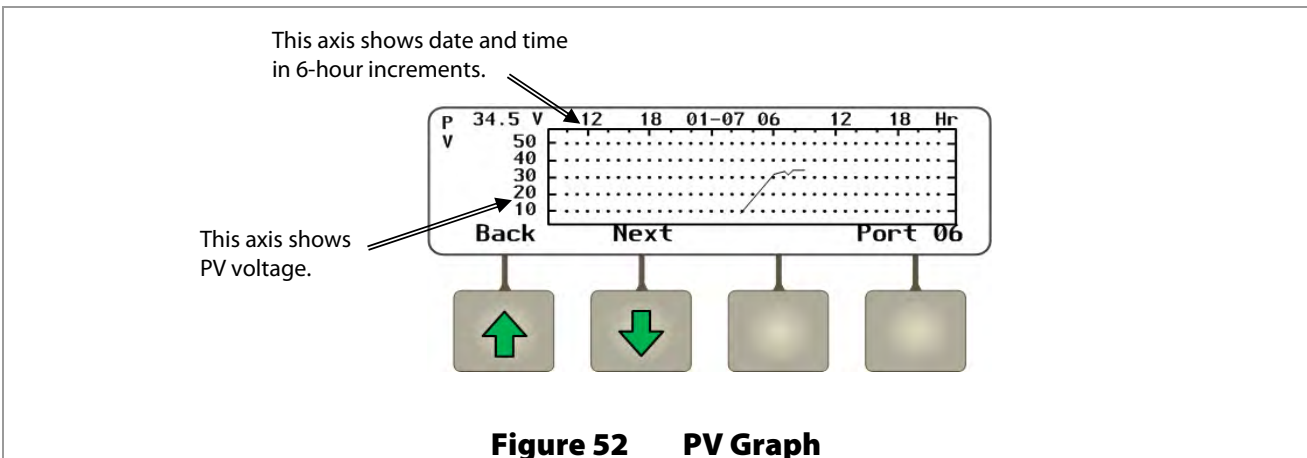

Continuing to press the **<Next>** soft key will proceed through the same graphs again from the beginning.

Hot Keys

Six hot keys are available to navigate through the most commonly used operational screens. Some screens will have operational options, such as ON, OFF, or AUTO. Some will show current operational status for that function. Status, mode, and measurements are the collective status of the system, not of an individual inverter, unless specified otherwise.

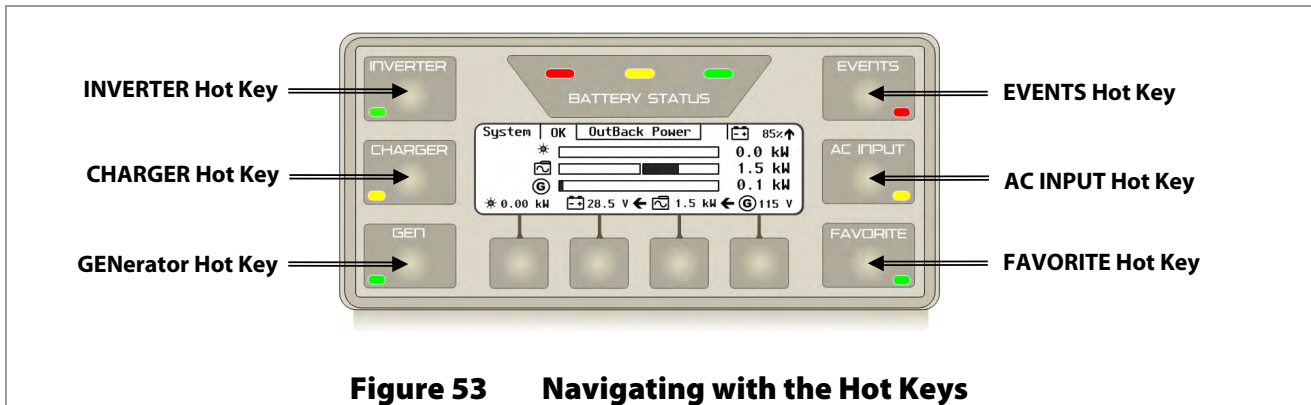

Figure 53 Navigating with the Hot Keys

INVERTER Hot Key

The **INVERTER** hot key displays the *Inverter Status* screen. The *Inverter Status* screen displays the current inverter mode, input and output voltage and wattage, battery voltage, and load draw.

INVERTER Hot Key

Inverter Status			
Mode	ON	Battery	28.5 V
Input	115 VAC 1.5 kW		
Output	115 VAC 0.0 kW	Load	0.0 kW
Back	On	Off	Search

Soft Key Options:

- <Back> returns to the Home screen.
- <ON> turns the inverter ON.
- <OFF> turns the inverter OFF.
- <Search> toggles the Search mode **ON** or **OFF**.

The **INVERTER** hot key can also be used to turn the inverter on or off. This is a global command issued to all inverters.

NOTE: Do not mistake the Inverter soft key for the **INVERTER** hot key. See page 37 for a comparison between the two.

Screen Items:

Mode displays the setting selected by the soft keys (<ON>, <OFF>, or <Search>).

Battery displays the battery voltage, not compensated for temperature. (See page 41 for the compensated value.)

Input displays the AC input source voltage and the power in kilowatts drawn from the AC source.

Output displays the voltage measured at the inverter's output and the power in kilowatts produced by the inverter. The inverter's produced power may equal the load wattage, but it may also include power sold to the grid (in grid-interactive inverters).

Load displays the power in kilowatts delivered to the inverter's output.

Figure 54 Using the INVERTER Hot Key

CHARGER Hot Key

The **CHARGER** hot key displays the **Charger Status** screen. The **Charger Status** screen displays the current charger mode, battery voltage, absorb and float voltage settings and timers. Soft key options include starting or stopping the charger, which is a global command issued to all inverters in the system. Other options include starting or the bulk or equalization charge functions, which are global commands issued to all inverters and charge controllers in the system.

NOTE: The charging information displayed on this screen is for inverters only. In a multiple inverter system, the master inverter controls this status. If an inverter or charge controller has a different charging status from the master inverter, this screen will not display its status.

CHARGER Hot Key

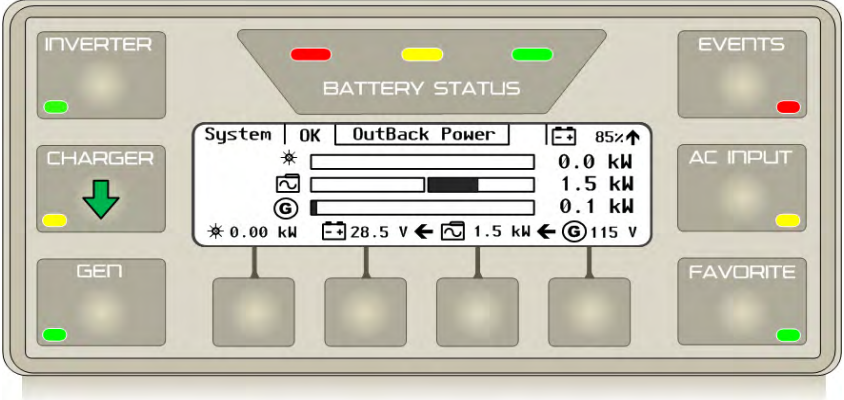

Charger Status			
Battery	28.5 V	Charger Control	ON
Absorb	29.2 V	00:00 remaining	
Float	26.8 V	00:00 remaining	
Back	Bulk Charge	EQ Charge	Charger Mode
↑	↓	↓	↓

Soft Key Options:

<Back> returns to the Home screen.

<Bulk Charge> advances to the **Bulk Charge** screen to start a new charging cycle.

<EQ Charge> advances to the **Equalize Charge** screen.

<Charger Mode> advances to the **Charger Mode** screen to enable or disable the charger.

Screen Items:

Battery displays the uncompensated battery voltage.

Charger Control displays the mode of the charger.

Absorb displays the target voltage for the Bulk and Absorption stages.

Float displays the target voltage for the Float stage.

If the timer is running to the right of either **Float** or **Absorb**, the system is in that charging stage.

Figure 55 CHARGER Hot Key



IMPORTANT:

Equalization should only be performed on certain kinds of batteries under specific conditions. Pressing the <Start EQ> soft key will bring up several recommendations and confirmations to ensure this function is not started accidentally.

From the **CHARGER** hot key's *Charger Status* screen, the **<Bulk Charge>** soft key brings up a screen that can start or stop the bulk stage of a new charging cycle.

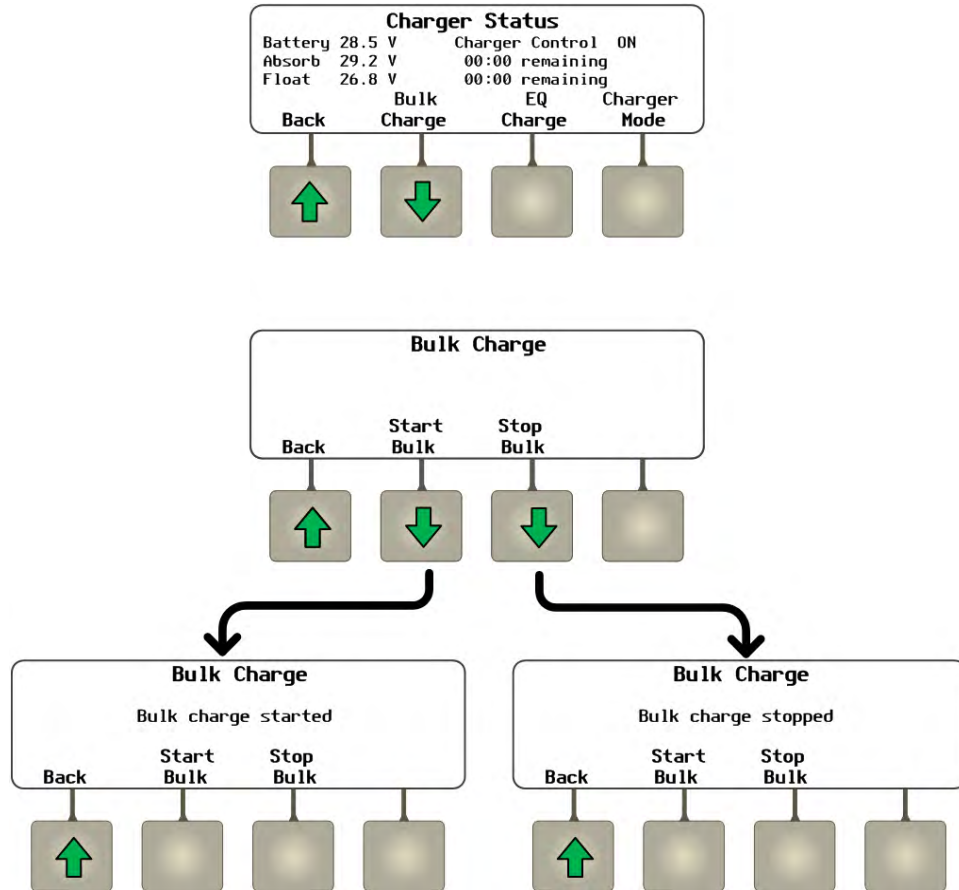

Soft Key Options:

<Start Bulk> starts a new charging cycle. The screen will display *Bulk Charge Started* when the **<Start Bulk>** soft key is pressed.

<Stop Bulk> stops a charging cycle once started. The screen will display *Bulk Charge Stopped* when the **<Stop Bulk>** soft key is pressed.

<BACK> returns to the *Charger Status Screen*.

Figure 56 Using the CHARGER Hot Key (Bulk Charge)

Operation

From the **CHARGER** hot key's *Charger Status* screen, the **<EQ Charge>** soft key brings up a series of screens that can turn on the battery equalization process.

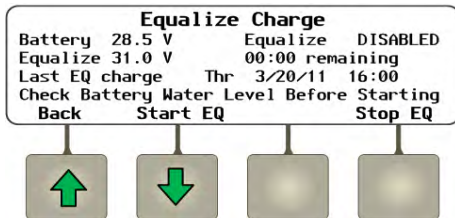
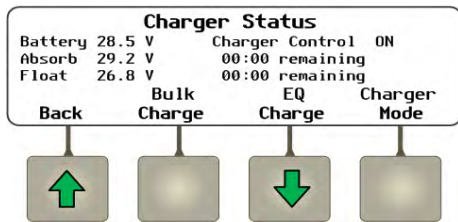

Soft Key Options:

<Back> returns to the *Charger Status* screen.

<Start EQ> starts the equalize charging stage.

<Stop EQ> stops the equalize charging stage.

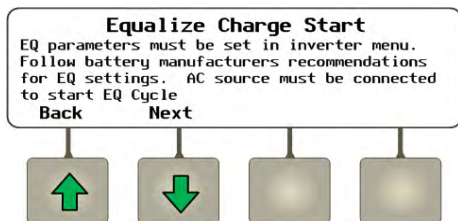

Screen Items:

Battery displays the uncompensated battery voltage.

Equalize (below **Battery**) displays the target voltage for the Equalization stage. The timer to the right of this item begins running once this voltage is reached.

Equalize (right side of screen) displays whether this mode is enabled or disabled.

Last EQ charge displays the date and time for the most recent equalization cycle.

Soft Key Options:

<Back> returns to the *Equalize Charge* screen.

<Next> advances to the confirmation screen.

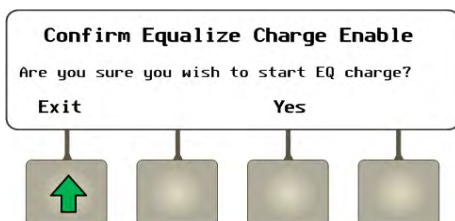

Soft Key Options:

<Exit> returns to the *Charger Status* screen.

<Yes> begins the equalization process and simultaneously returns to the *Equalize Charge* screen. The process can be stopped by pressing the **<Stop EQ>** soft key on the *Equalize Charge* screen.

Figure 57 Using the CHARGER Hot Key (EQ Charge)

From the **CHARGER** hot key's **Charger Status** screen, the **<Charger Mode>** soft key brings up a screen that can turn on or turn off the charger. (See the inverter *Operator's Manual* for a description of specific charger functions.)

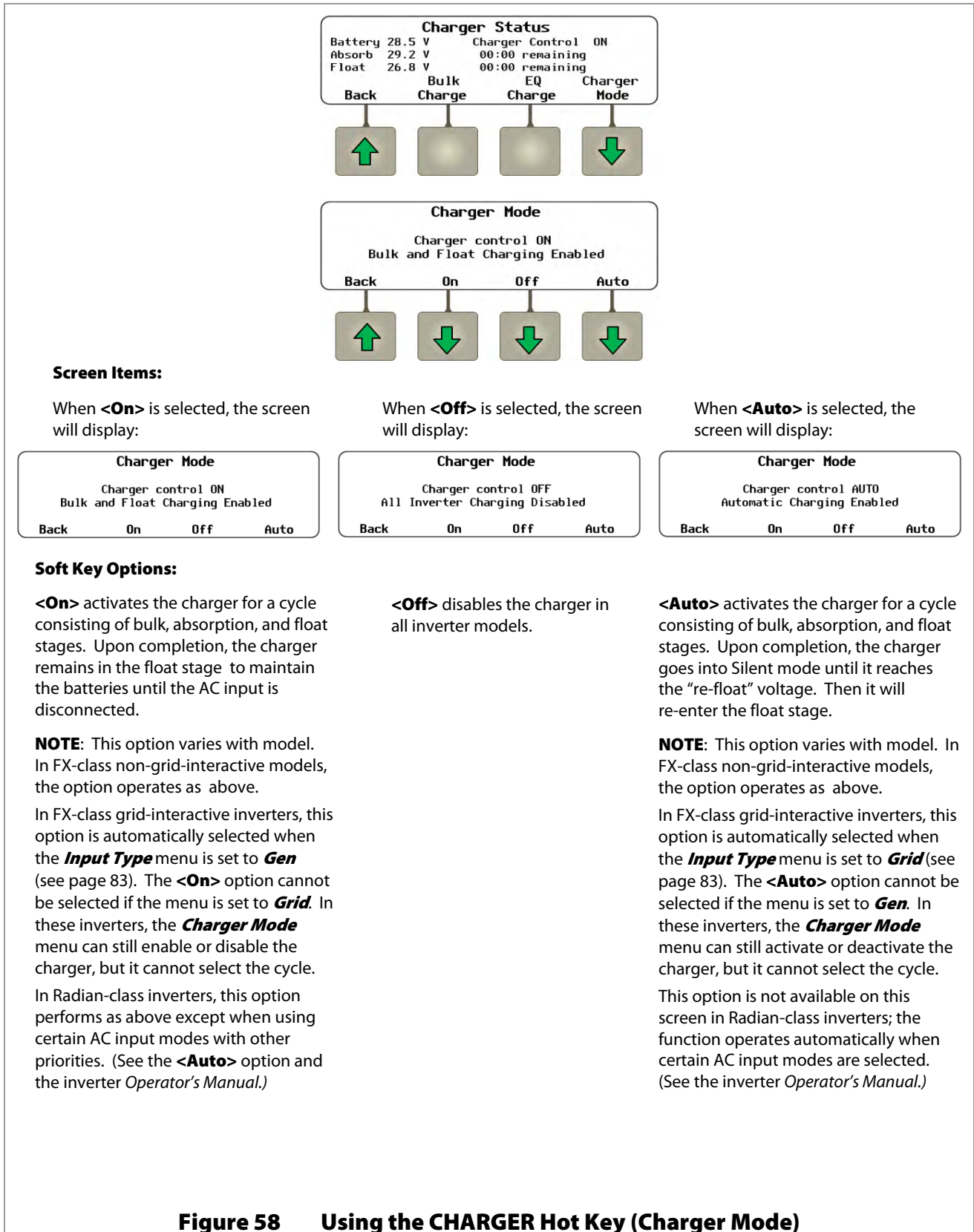

Figure 58 Using the CHARGER Hot Key (Charger Mode)

GENERator Hot Key

The **GEN** hot key displays the **Generator Status** screen. The **Generator Status** screen displays information on the Advanced Generator Start (AGS) mode. Soft key options include: **<Back>**, **<Auto>**, **<Off>**, and **<On>**.

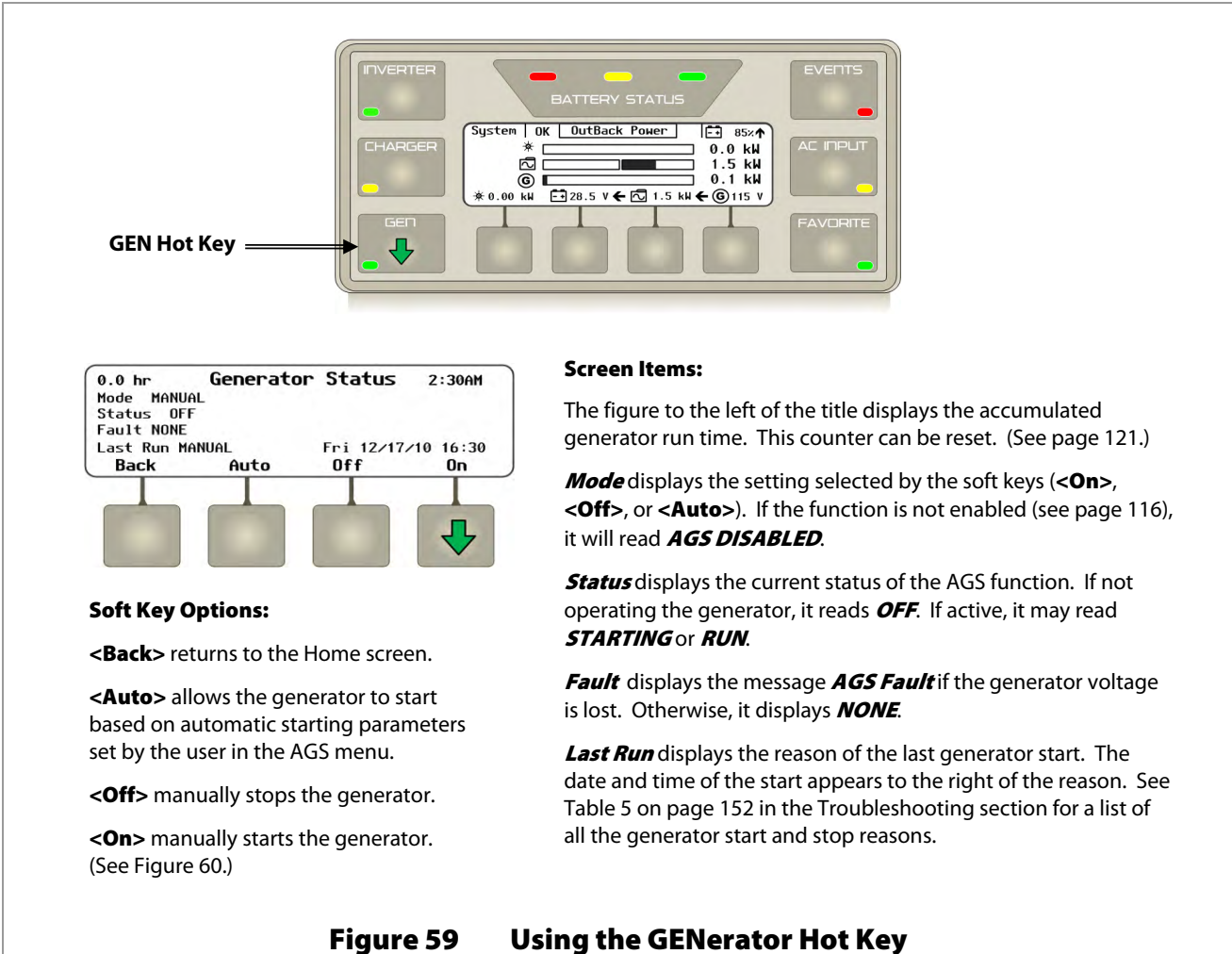
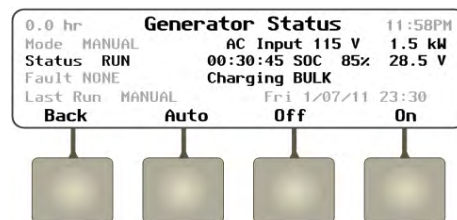

Figure 59 Using the GENERator Hot Key

When **<On>** is pressed, generator data appears on the right side of the screen.

- The first line displays the generator's AC voltage and the number of kilowatts being used from the generator.
- The second line displays the updated status **RUN**, the length of time since the start command was sent, the battery state of charge (**SOC**), and the battery voltage. (If no battery monitor is present, the **SOC** field will be blank.)
- The third line displays the charging stage.



NOTE: The generator can only be started if the AGS mode is enabled in **AGS Setup** (see page 116). If it is not enabled, this information will not appear.

Figure 60 Generator Status Screen

EVENTS Hot Key

The **EVENTS** hot key displays the **Event History** screen. An event is defined as a change in status that was externally imposed on a device on the HUB. A command to turn the inverter off or on, an automatic generator start, or a loss of grid power are all defined as events. An event is not necessarily the sign of a problem; however, the **Event History** screen logs all events for potential troubleshooting. In addition, Errors, Warnings, and AGS Faults are accompanied by the Events LED.

- If the event is an inverter-based warning, the LED will flash.
- If the event is an inverter-based error, then the LED will be on solid. Errors are usually accompanied by the inverter shutting down. Some warnings can become errors if left unattended.
- An AGS Fault is based in the MATE3. In this case, the LED will be on solid. This fault usually indicates an automatic generator problem and is not accompanied by an inverter shutdown.
- Multiple events may occur simultaneously.

Soft key options include scrolling through each event and displaying details about that event to determine if corrective action is required. Events may require acknowledgement before the EVENTS LED will turn off. See page 150 for more information on troubleshooting event messages.

Event logs can be saved to an SC card. Refer to page 142 for instructions.

See page 42 to view the **Inverter Warnings** and see page 43 for the **Inverter Errors** menus. See the inverter *Operator's Manual* for descriptions of errors, warnings, and other troubleshooting.

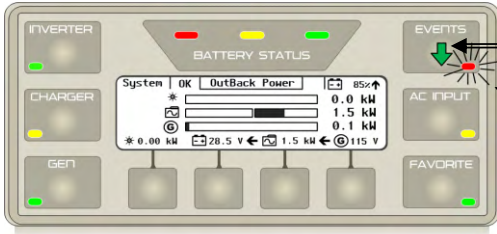

EVENTS Hot Key
Error – Solid
Warning – Flashing



Soft Key Options:

- <Back> returns to the Home screen.
- <Next> highlights the next event in the list.
- <Prev> highlights the previous event in the list.
- <Detail> displays the details of the selected event, and prompting for acknowledgement, if necessary.

Screen Items:

The left side of the screen lists the nature of the event.

The word **Fault** will appear on the right side of the screen if the event requires acknowledgement.

NOTE: The control wheel will also scroll up and down the list in the **Event History** screen.

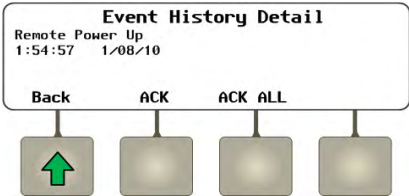

Soft Key Options:

- <Back> returns to the **Event History** screen.
- <ACK> will acknowledge one open event.
- <ACK ALL> will acknowledge all open events.

Screen Items:

If the <ACK> and <ACK ALL> soft keys appear, either must be pressed to acknowledge the event. Once acknowledged, the EVENTS LED will turn off. An acknowledgement (**ACKED**) will replace the word **Fault** in the **Event History** screen.

NOTE: Using the control wheel in the **Event History Detail** screen will display the detail for the previous, or the next, event as listed in the **Event History** screen.

Figure 61 Using the EVENTS Hot Key

AC INPUT Hot Key

The **AC INPUT** hot key displays the **AC Input Status** screen. The **AC Input Status** screen displays the AC input mode, the AC input status, and the current AC frequency and voltage. Soft key options include manually using or dropping the AC input source or viewing the **Last AC Disconnect** screen. The **Last AC Disconnect** screen indicates the reason the AC source may have been disconnected. These reasons will vary between inverter models. See the inverter *Operator's Manual* for more information on troubleshooting a specific message.

Screen Items:

AC Input Select (Radian-class only) displays which of two inputs was set as first priority for the inverter. See page 83. This item is not present in FX-class inverters.

AC Input Mode allows soft key options to be selected to change the mode. This item may be overridden by other commands. For example, a system that is set to **DROP** will automatically switch to **USE** if AGS starts the generator.

Next to the current **AC Input Mode** is the last reason the status was changed. In this illustration, the status changed due to an **HBX-SOC** event. Other possible reasons for a status change are **Manual, AGS, Grid-Time, or HBX-Voltage**.

AC Input Status displays the current interaction with the AC input. This screen will usually change to match **AC Input Mode** once a soft key command is given.

NOTE: In Radian-class inverters, the displayed AC voltage is the sum of the L1 and L2 phases.

Figure 62 Using the AC INPUT Hot Key

Screen Items (all inverters):

Input Frequency Too High, N= No, Y= Yes

Input Frequency Too Low, N= No, Y= Yes

Input Voltage > Maximum, N= No, Y= Yes

Input Voltage < Minimum, N= No, Y= Yes

Additional Screen Items (Radian-class only)

Backfeed, N= No, Y= Yes

Phase Lock, N= No, Y= Yes

Island Detect, N= No, Y= Yes

Soft Key Options:

<Back> returns to the **AC Input Status** screen.

<Port> cycles through all the devices connected to the HUB.

Figure 63 AC Disconnect Reasons

FAVORITE Hot Key

The **FAVORITE** hot key allows the user to program and select up to four frequently used (or “favorite”) screens for rapid access. It includes a green LED.

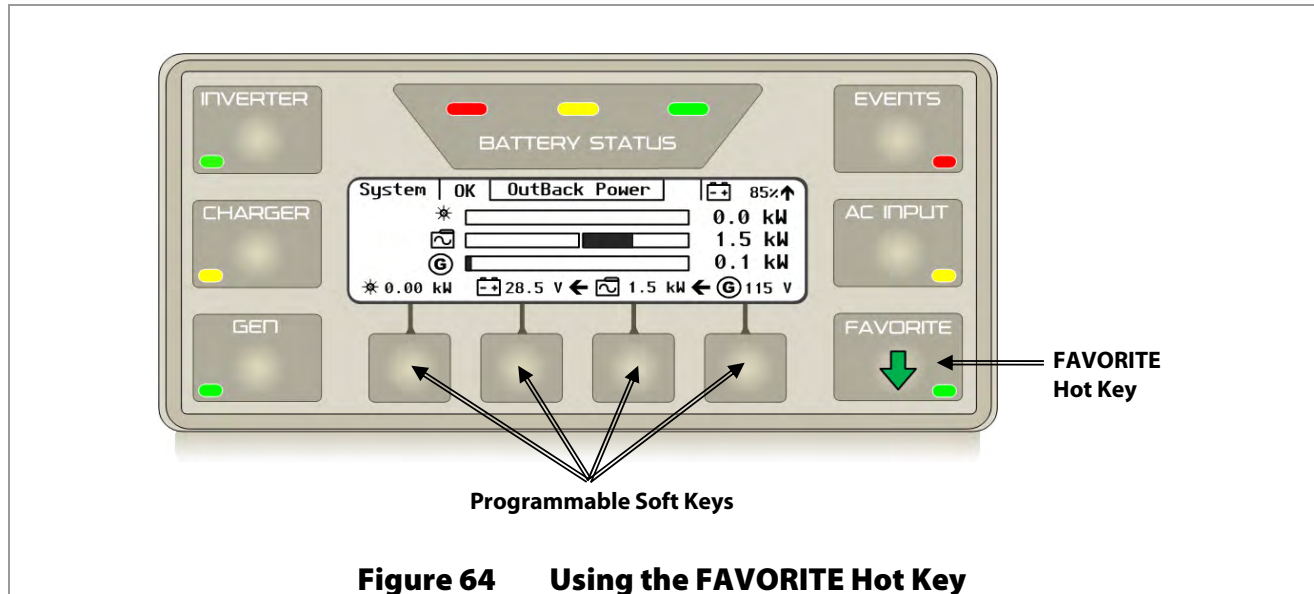

To program the FAVORITE hot key:

1. Navigate to the desired screen.
2. Press and hold the **FAVORITE** hot key until the green LED flashes.
3. Press one of the four programmable soft keys to select it for recalling that particular screen. The green LED will stop flashing.
4. Repeat Steps 1-3 to program three more favorite screens (if desired).



IMPORTANT:

- Only one favorite screen can be programmed per soft key. Attempting to program more than one favorite screen to the same soft key will overwrite the first screen.
- Password-protected screens cannot be saved as favorites. This means that any screen that is accessed with the **<LOCK>** key cannot be saved this way.

To use the FAVORITE hot key to recall the desired screen(s):

1. Press and release the **FAVORITE** hot key. The green LED will illuminate and stay on.
2. Press the soft key for the desired screen to be recalled. If no selection is made after pressing the **FAVORITE** hot key, the function will deactivate and the green LED will turn off.
3. To return to the Home screen from the “favorite” screen, press the **<BACK>** soft key.

Controls and Navigation Keys

Removing the Front Cover

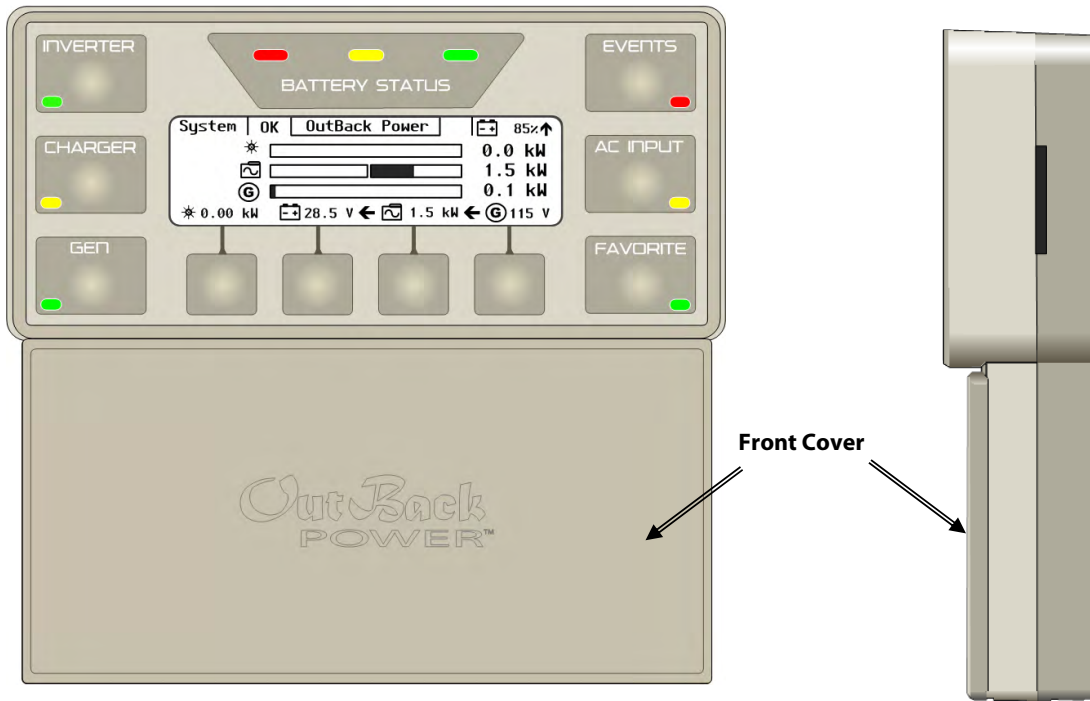

To remove the front cover:

Gently pull on the front cover. The navigation panel is magnetic and the front cover will pull off with a small amount of force.

To replace the front cover:

1. Place the front cover over the navigation section.
2. Allow the magnets to pull the front cover in place.

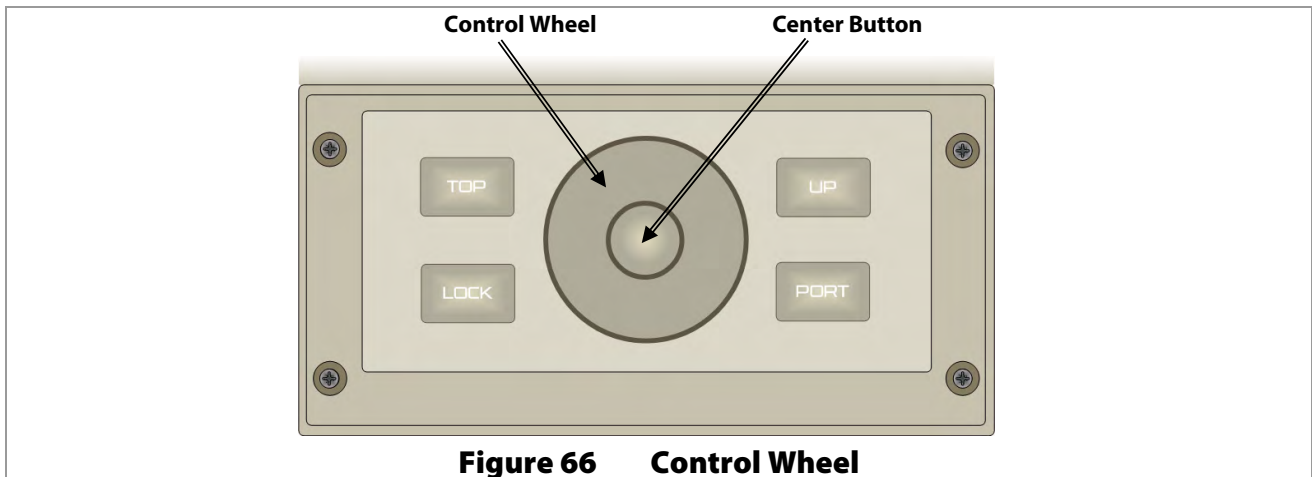

Figure 65 Removing the Front Cover

Control Wheel

The control wheel is a touch-sensitive navigation control with a center button located on the lower half of the MATE3.

- The control wheel scrolls forward or backward in the menu map. When the desired menu is highlighted, press the center button to move forward into that menu map. See Figure 182 through Figure 189 starting on page 162 for a complete menu map.
- On screens with set points, the control wheel serves two functions; navigation and set point adjustment. It navigates through the set points by highlighting each set point field with a box. This is called the *Field Select* mode. When the desired field is highlighted, pressing the center button changes the appearance of the box to solid. This is the *Adjust Set Point* mode. The set points can now be adjusted by using the control wheel; clockwise increases the value, counterclockwise decreases the value. When the set point is correct, press the center button again to return to *Field Select* mode. (See Figure 70.)
 - ~ Set points are adjustable settings for each specific menu item.
 - ~ Set points will vary depending on the system configuration.



To use the control wheel:

Touch the control wheel anywhere and make a circular motion around the wheel.

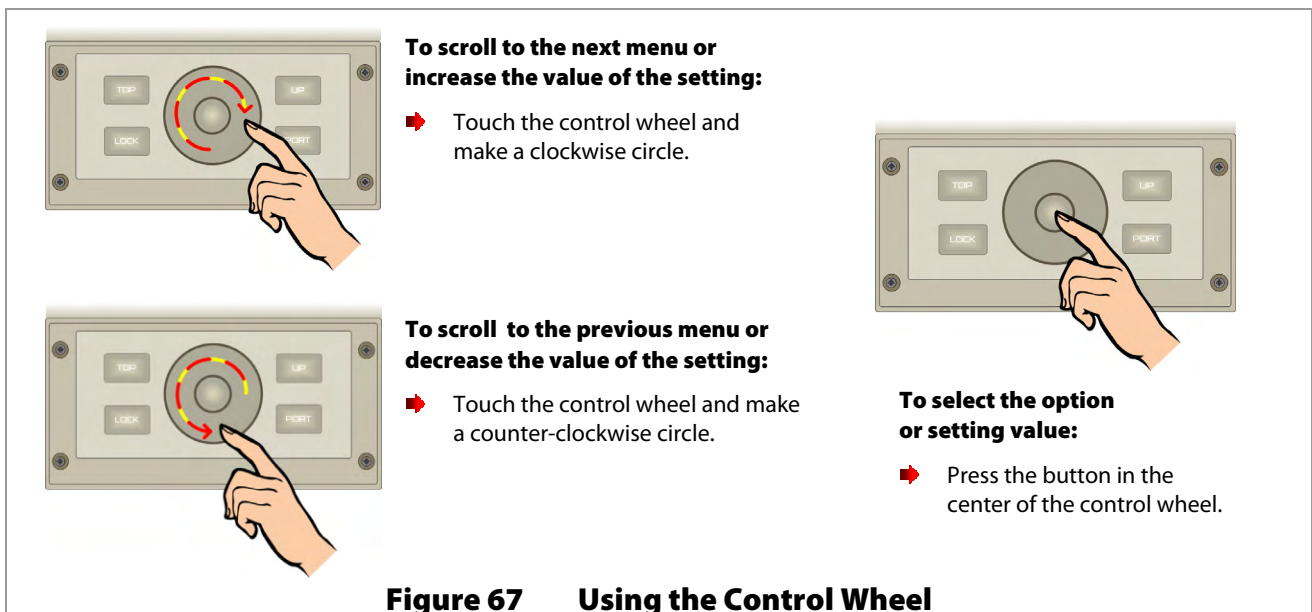

Navigation Keys (buttons)

Four navigation keys are located on the lower half of the MATE3. The navigation keys help the user move around within the menu structure. They also provide access to the **Main Menu** programming and the ability to access the various components connected to the HUB.

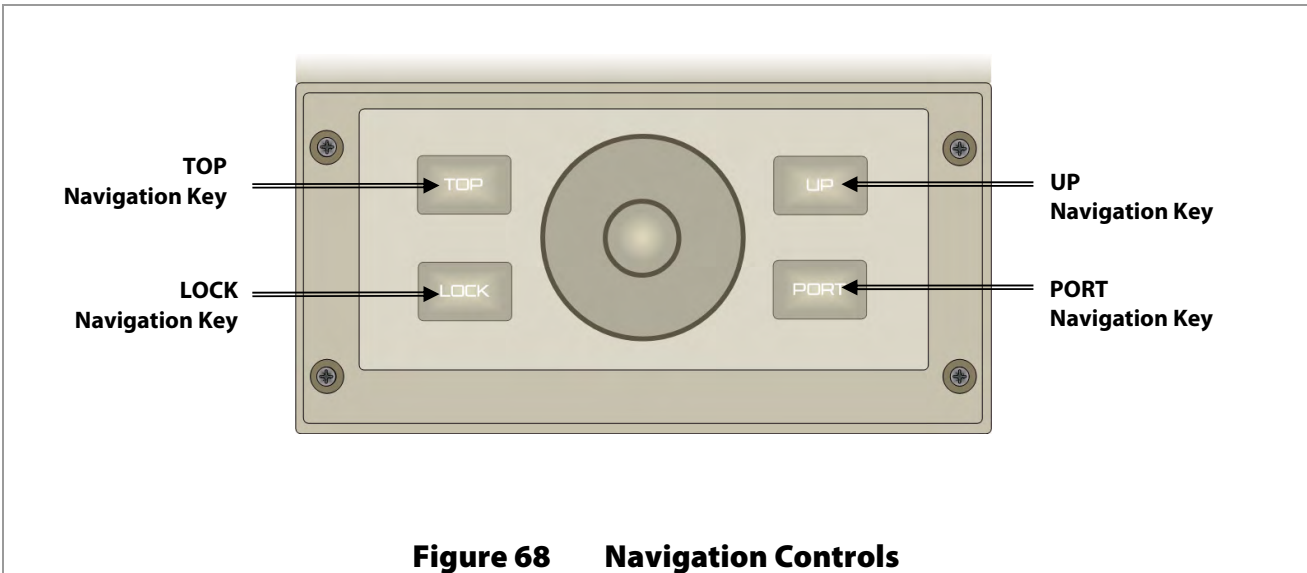

- The **TOP** navigation key returns the operator to the top of the **Main Menu** for the selected device. From the **Main Menu**, the **TOP** key or **<LOCK>** returns the operator to the Home screen.
- The **LOCK** navigation key locks the access to prevent unauthorized changes to the system settings. It also provides access to the **Enter Password** screen. (See page 71.)
- The **UP** navigation key returns to the menu item on the previous screen that was used to access the current screen. It moves up, or back, one screen in the menu map for the selected device. See page 162 for a complete menu map.
- The **PORT** navigation key cycles through each device connected to a port on the HUB.

See Figure 69 on page 67 for an illustration on how to use the navigation keys.

To go to the Home screen from the **Main Menu**, press the **<TOP>**, **<UP>**, or **<LOCK>** button.

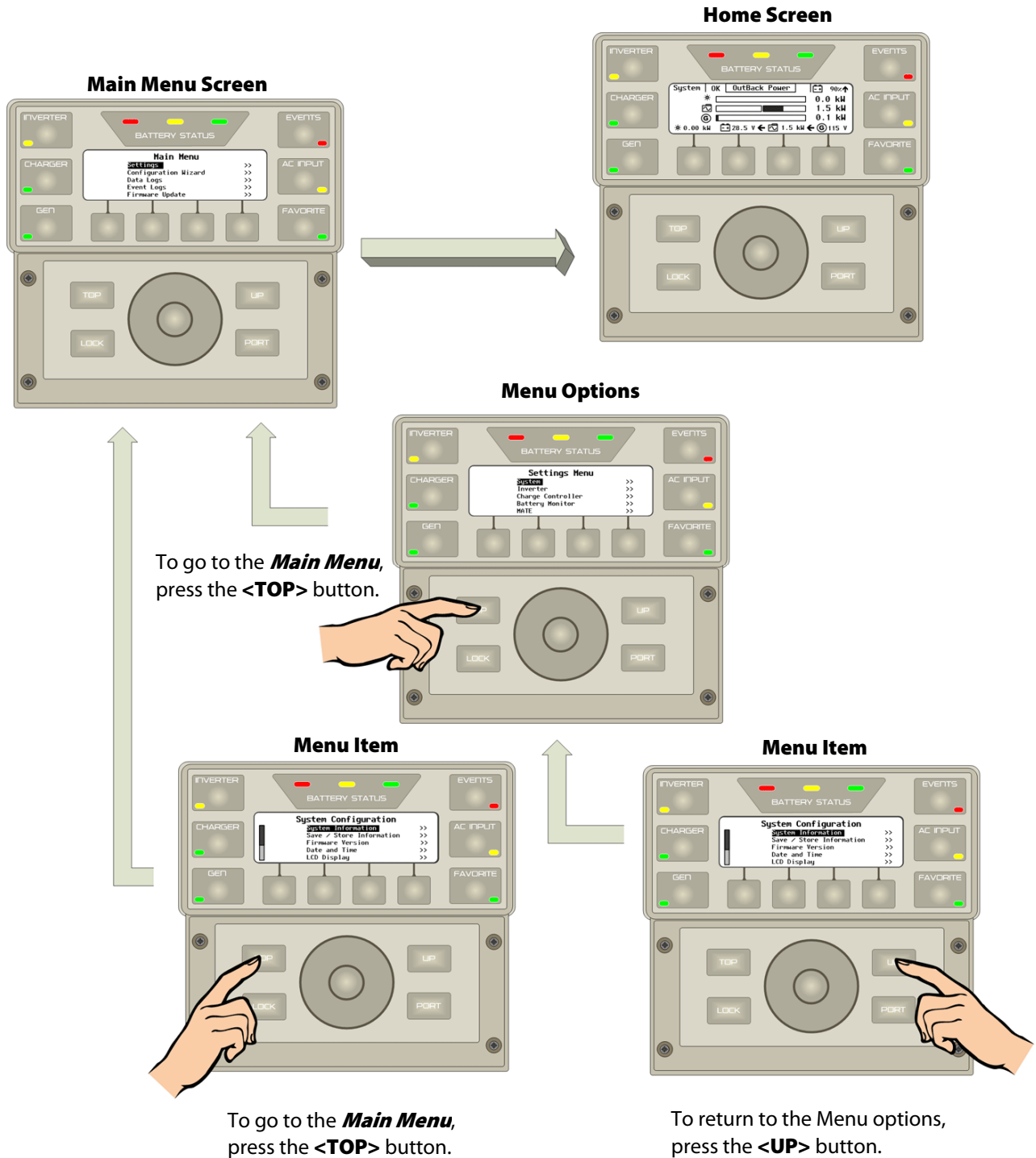

Figure 69 Using the Navigation Keys

Adjusting Set Points

When a screen with set points is available, the set points will be identifiable by a black box around the field. This indicates that the menu is in the *Field Select* mode. To change to the *Adjust Set Point* mode, follow the instructions below.

To adjust set points:

1. Use the control wheel to navigate to the desired set point to be adjusted.
The field is identified by a black box around the field (*Field Select* mode). Using the control wheel in this mode will move the black box to each field in sequence.
2. When the desired set point is selected, press the center button. The box around the field should become solid (*Adjust Set Point* mode).
3. Use the control wheel to change the set point value.
4. When the set point is correct, press the center button again to return to *Field Select* mode.
5. Repeat Steps 1-4 for each set point to be adjusted.

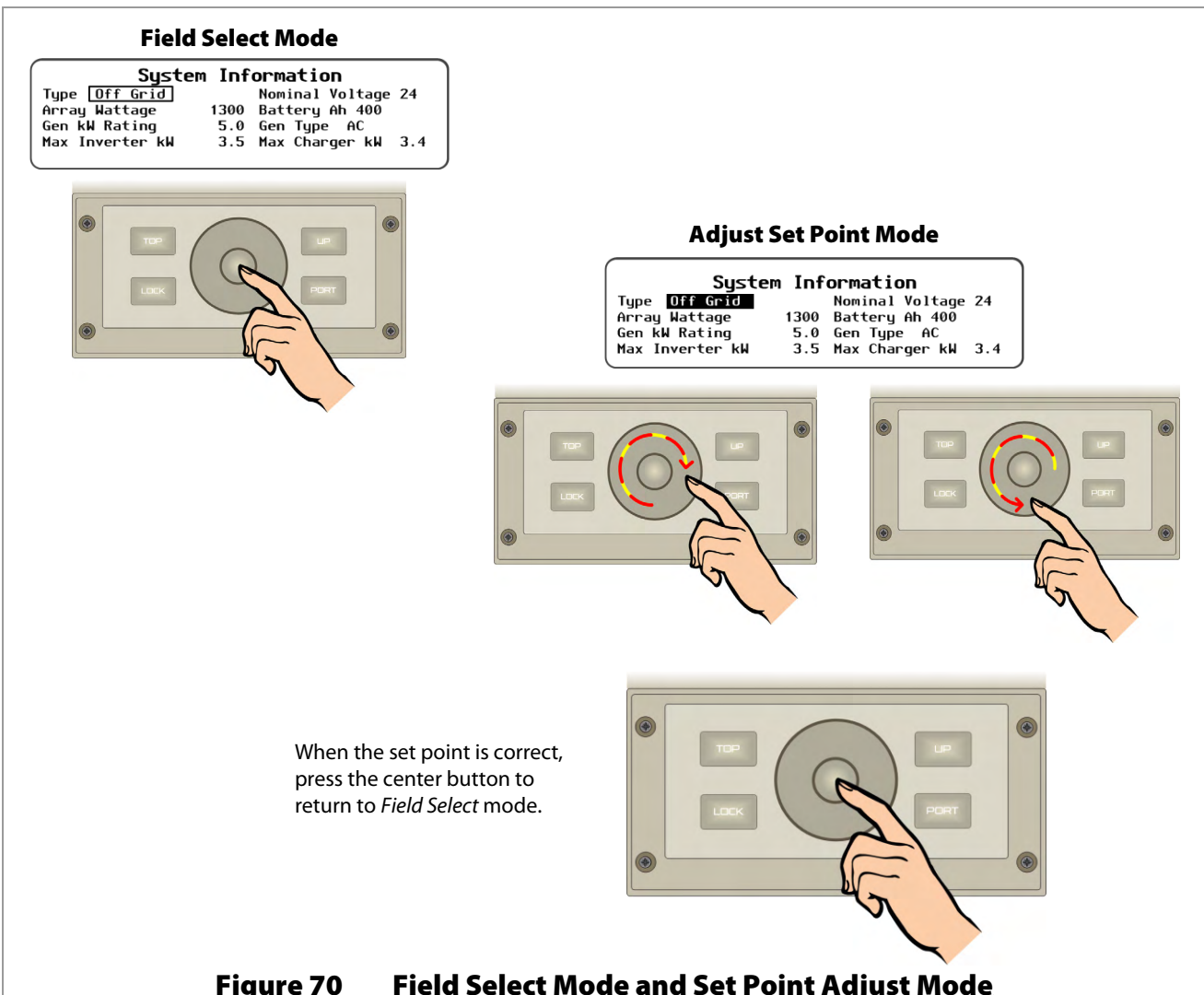



Programming

Programming an OutBack system may involve the following settings.

- **System** settings (page 72). These include:
 - ~ **System Information**-----> See page 73.
 - ~ **Save/Restore Configuration**-----> See page 74.
 - ~ **Firmware Revision**-----> See page 76.
 - ~ **Date and Time**-----> See page 74.
 - ~ **LCD Display**-----> See page 77.
 - ~ **Sound**-----> See page 78.
 - ~ **Ethernet Addresses**-----> See page 78.
 - ~ **Ethernet Ports**-----> See page 79.
 - ~ **Data Stream**-----> See page 79.
 - ~ **System Name**-----> See page 79.
 - ~ **Installer Information**-----> See page 80.
 - ~ **Installer Settings**-----> See page 79.
- **Inverter** parameters (page 82). These include:
 - ~ **Search**-----> See page 82.
 - ~ **AC Input Current Limit**-----> See page 83.
 - ~ **Grid AC Input Voltage Limits (FX-class only)**-----> See page 85.
 - ~ **Gen AC Input Voltage Limits (FX-class only)**-----> See page 85.
 - ~ **Grid AC Input Mode and Limits (Radian-class only)**-----> See page 86.
 - ~ **Gen AC Input Mode and Limits (Radian-class only)**-----> See page 87.
 - ~ **AC Output**-----> See page 88.
 - ~ **Low Battery**-----> See page 88.
 - ~ **Battery Charger**-----> See page 89.
 - ~ **Battery Equalize**-----> See page 89.
 - ~ **Auxiliary Output**-----> See page 90.
 - ~ **Auxiliary Relay (Radian-class only)**-----> See page 96.
 - ~ **Inverter Stacking**-----> See page 99.
 - ~ **Grid-Tie Sell**-----> See page 101.
 - ~ **Calibrate**-----> See page 102.
 - ~ **Reset Inverter to Factory Defaults**-----> See page 103.
- **Charge Controller** limits (page 104). These include:
 - ~ **Charger**-----> See page 104.
 - ~ **MPPT**-----> See page 105.
 - ~ **Temperature Compensation**-----> See page 106.
 - ~ **Battery Equalize**-----> See page 106.
 - ~ **Grid Tie Mode**-----> See page 107.
 - ~ **Auxiliary Output**-----> See page 107.
 - ~ **Restart Mode**-----> See page 110.
 - ~ **Calibrate**-----> See page 110.
 - ~ **Reset to Factory Defaults**-----> See page 111.
- **Battery Monitor** parameters (page 112). These include:
 - ~ **Battery Setup**-----> See page 112.
 - ~ **Shunt Enable**-----> See page 112.
 - ~ **Relay Mode**-----> See page 113.
 - ~ **Relay Set Points**-----> See page 113.
 - ~ **Reset FLEXnet DC to Factory Defaults**-----> See page 114.

Programming

- **MATE3** settings (page 115). These include:
 - ~ **Advanced Generator Start** -----> See page 115.
 - 1. **Setup** -----> See page 116.
 - 2. **Voltage Start** -----> See page 118.
 - 3. **Load Start** -----> See page 118.
 - 4. **State-of-Charge Start** -----> See page 118.
 - 5. **Must Run Schedule** -----> See page 119.
 - 6. **Quiet Time Schedule** -----> See page 119.
 - 7. **Generator Exercise Schedule** -----> See page 120.
 - 8. **Set Total Generator Run Time** -----> See page 121.
 - 9. **Display AGS Timers** -----> See page 121.
 - ~ **Data Logging** -----> See page 122.
 - ~ **High Battery Transfer** -----> See page 122.
 - ~ **Grid Use Time** -----> See page 125.
 - ~ **Charge Controller Float Coordination** -----> See page 127.
 - ~ **Global Charger Output Control** -----> See page 127.
 - ~ **FLEXnet DC Advanced Control** -----> See page 127.
 - ~ **Reset to Factory Defaults** -----> See page 129.

Types of Settings

The OutBack MATE3 accommodates a wide range of time-based and voltage-level functions and conditions for maximum control of the power system.

The following types of settings may require adjustments depending on the specific installation:

- start and stop times for different sources of energy (when to use grid-supplied power, stored battery power, or generator-supplied power),
- frequency and duration of battery recharging (based on the requirements of the battery manufacturer), and
- inverter response to battery voltage (low battery cut-out, low battery cut-in).

For additional information and discussion on the OutBack MATE3, go to:

www.outbackpower.com and join our forum discussions.

Set Points

A set point is a condition, measurement, or baseline that a user establishes in order for something else to happen (such as when to start or stop a generator).

For example:

- **Example #1.** With a home thermostat, when predetermined temperatures and times are set for weekdays and weekends, the thermostat signals to a heating/cooling system to turn on at one time until a certain temperature is reached, maintain that temperature, and finally shut off at a later time, usually during sleep hours to conserve energy. Otherwise, the user would have to manually control the system.
- **Example #2.** A timed light will turn on and off based on a specified time or level of ambient light, or possibly by detecting motion.

The MATE3 allows a user to view, monitor, and establish all the settings and values that occur while the system is running. From time to time, these settings and values may be adjusted as components are added or upgraded, electrical loads increase, or patterns of usage change.

Access to the Main Menu

Programming the system is done in the **Main Menu** screen. A password is required to access the **Main Menu** screen. This password, **141**, cannot be changed.

To access the Main Menu, enter the password as follows:

1. Press the **LOCK** button.
2. While touching the control wheel, make a clockwise circle until the display shows **141**.
3. Press the center button on the control wheel to accept the password.

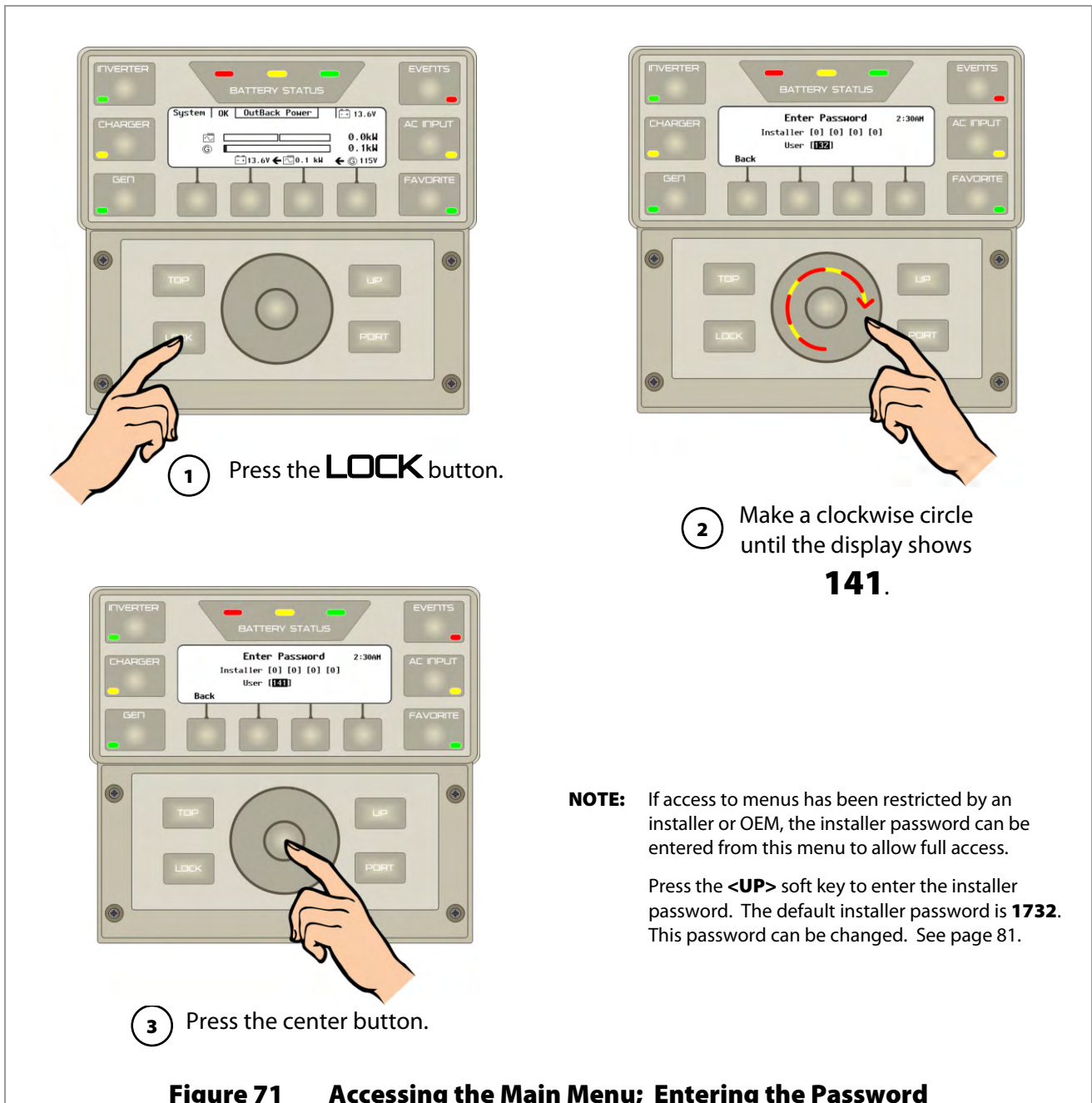

Main Menu Structure

All programming menus are accessed from the **Main Menu** screen. Menus include the following:

- **Settings** (System, Inverter, Charge Controller, Battery Monitor, MATE3) -----> See page 73.
- **Configuration Wizard** -----> See page 130.
- **Device Data Logs** -----> See page 139.
- **Event Logs** -----> See page 142.
- **Firmware Updates** -----> See page 145.

Each menu has its own set of menu options. Each menu option has its own set of menu items.

For complete menu map, see page 161.

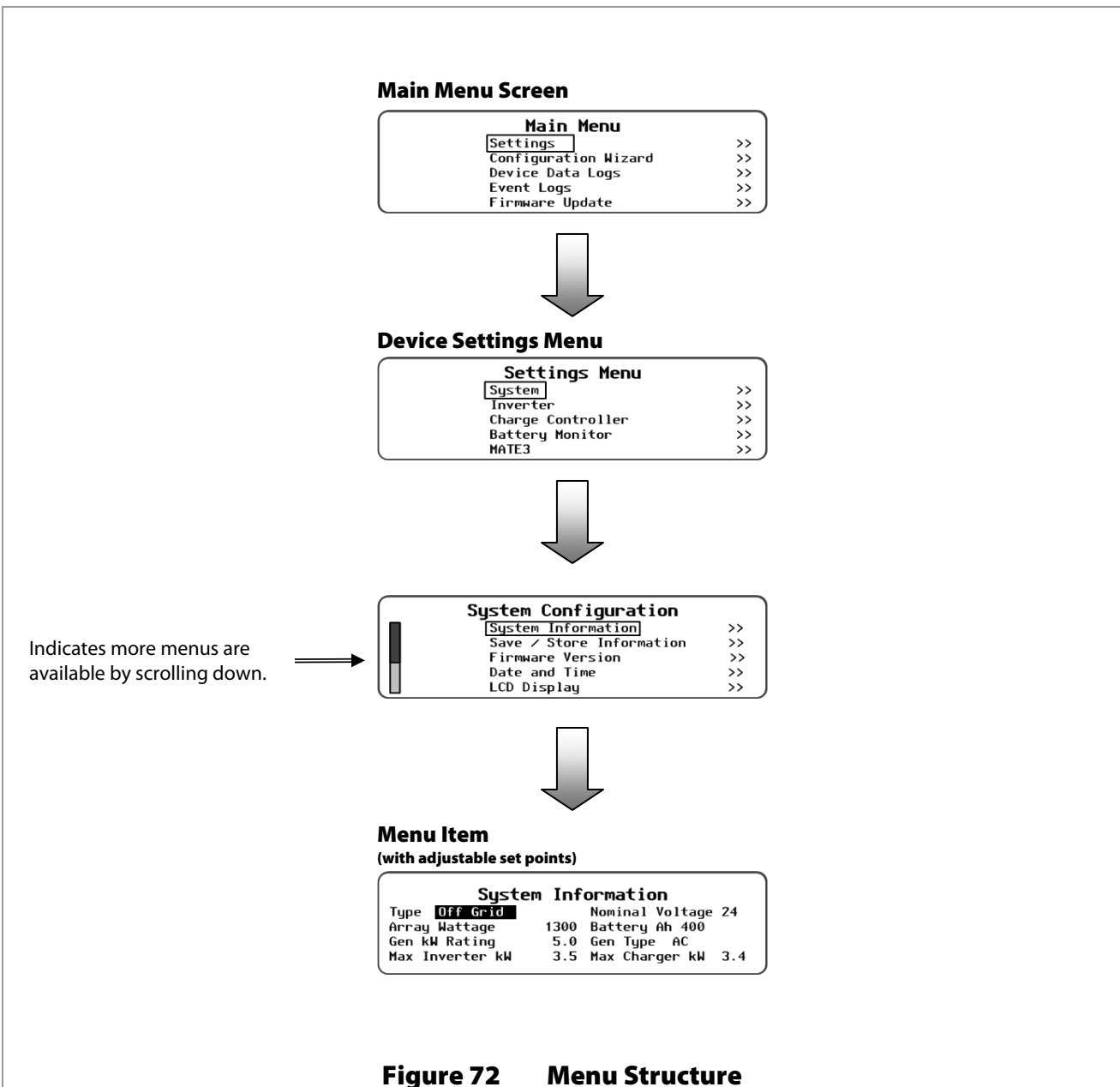

Figure 72 Menu Structure

Settings Menus

- The system **Settings** menus are used for programming functions for the overall system (e.g., date and time, communication options).
- The device **Settings** menus are used to program the various system components (e.g., inverter, charge controller, battery monitor, and MATE3). The system profile is made up of the combination of all these settings.
- The **Settings** menus are accessed in the **Main Menu** using the **Lock** key. See Figure 71 on page 71 for instructions on accessing the **Main Menu**.
- Once the settings have been changed to match the configuration, they are stored in the MATE3's static memory.
- It is recommended once the configuration has been established, save the data to an SD card. That way, the configuration can be restored without having to repeat each setting individually.



IMPORTANT:

If multiple inverters are used in the installation, make certain to change settings as appropriate for each inverter on its assigned port. Changing settings for a single inverter in a multiple-inverter system may result in conflicts in operation.

Settings Menu	See pages...	Notes
System	below to page 80	
Inverter	82 to 103	See the inverter <i>Operator's Manual</i> for details about functional features of the inverter.
Charge Controller	104 to 111	Detailed information about basic setup for a FLEXmax charge controller is available in the <i>FLEXmax 60/80 Charge Controller Owner's Manual</i> . The MATE3 can be connected to an MX60 Charge Controller, but only monitoring features will be available. The MATE3 will not be able to program the MX60.
Battery Monitor	112 to 114	Detailed information about basic setup for a FLEXnet DC is available in the <i>FLEXnet DC Owner's Manual</i> .
MATE3	115 to 129	

System Settings

System **Settings** menu include the following menu options:

- **System Information** ----- > See page 74.
- **Save/Restore Configuration** ----- > See page 74.
- **Firmware Version** ----- > See page 76.
- **Date and Time** ----- > See page 74.
- **LCD Display** ----- > See page 77.
- **Sound** ----- > See page 78.
- **Ethernet Addresses** ----- > See page 78.
- **Ethernet Ports** ----- > See page 79.
- **Data Stream** ----- > See page 79.
- **System Name** ----- > See page 79.
- **Installer Information** ----- > See page 80.
- **Installer Settings** ----- > See page 80.

System Information

The **System Information** screen contains a basic profile of the system.

- Type of system (Off Grid, Grid Tied, Backup)
- Nominal voltage of the battery bank
- Array wattage (PV)*
- Battery Amp-hours
- Generator kW rating* and type
- Inverter and charger kW rating*

*Used to scale the Home screen meter bars.

System Information			
Type	Off Grid	Nominal Voltage	24
Array Wattage	1300	Battery Ah	400
Gen kW Rating	5.0	Gen Type	AC
Max Inverter kW	3.5	Max Charger kW	3.4

Set Points:

- **Type** – *Off Grid, Grid Tied, Backup*. See page 33 for details on the respective Home screens.
- **Array Wattage** – Allows for a PV Array (or arrays) with a total wattage range of **0** to **50** kW.
- **Generator kW Rating** – Allows for a generator with a range of **0** to **250** kW.
- **Maximum Inverter kW Rating** – Allows for an inverter system with a wattage of **0** to **72** kW.
- **Nominal Voltage** – Allows for a battery bank with a voltage of **12, 24, 36, 48** or **60** Vdc.
- **Battery Ah** – Allows for total amp-hour rating of the batteries from **25** Ah to **10,000** Ah.
- **Generator Type** – Allows for an **AC** or **DC** Generator, or **None**.
- **Maximum Charger kW Rating** – Allows for a system with a total charger rating of **0** to **60** kW.

Figure 73 System Information Menu Item

Save / Restore Configuration

The **Save / Restore Configuration** allows for saving a configuration to an SD card after manual programming is complete. It is also used to restore (or copy) a configuration from an SD card to an identical system configuration.

Save / Restore Configuration	
Save System Configuration	>>
Restore System Configuration	>>

Figure 74 Save / Restore Configuration Menu Item

Saving a Configuration to an SD Card

To save a configuration to an SD card:

- From the **Main Menu**, select **Settings**.
- From the **Settings Menu**, select **System**.
- From the **System Configuration** menu, select **Save/Restore Information**.
- Select the **Save System Configuration** menu item.
- If other profiles have been saved on the SD card, a list will be displayed. Choose one of the following options.
 - Press **<Save>** to save the new settings over the name that is selected on the list.
OR
 - Press **<New>** to create a new name for the profile. See the instructions below for entering a new name.
OR
- After performing one of the two options above, press **<Continue>** to return to the **Main Menu**.

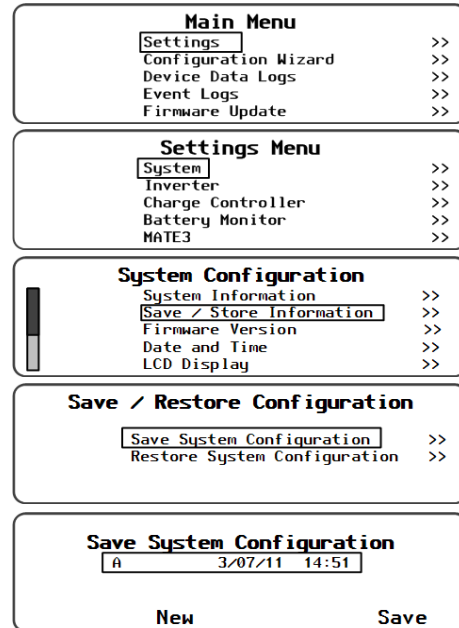

To save the new profile over the name highlighted on the list:

- Use the control wheel to scroll through the list.
- When the name to be replaced is highlighted, press **<Save>**.
- Wait for the message confirming that the profile has been saved to the SD card.
- Press **<Continue>** to return to the **Main Menu**.

NOTE: If the SD card is empty, pressing the **<Save>** soft key will automatically default to the **New Wizard Configuration File** menu to allow a name to be entered (up to 8 characters maximum).

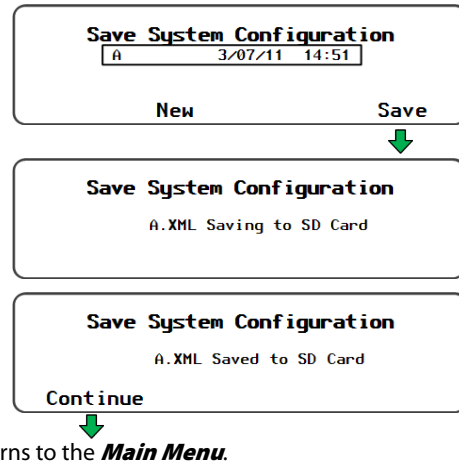

Returns to the **Main Menu**.

To create a new name for the profile (up to 8 characters maximum):

- Use the control wheel to scroll through the available characters.
- Use **<→>** or **<←>** to move to the desired character location.
- Press **<Delete>** to erase the character that is highlighted.
- Press **<Save>** to save the new profile on the SD card.
- Press **<Continue>** to return to the **Main Menu**.

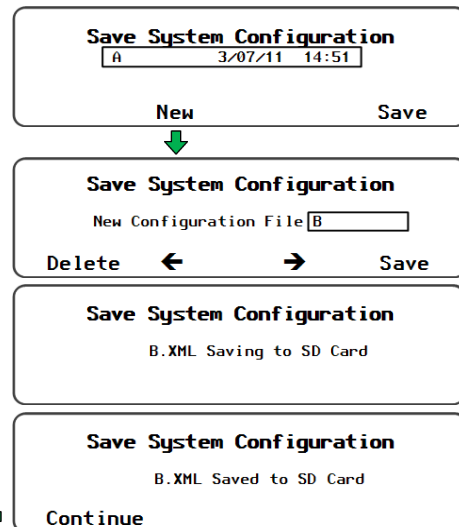

Returns to the **Main Menu**.

Figure 75 Saving the Configuration to an SD Card

Restoring a Configuration from an SD Card

To restore a configuration from an SD card:

1. From the **Main Menu**, select **Settings**.
2. From the **Settings Menu**, select **System**.
3. From the **System Configuration** menu, select **Save/Restore Information**.
4. Select the **Restore System Configuration** menu item.
5. If other profiles have been saved on the SD card, a list will be displayed. Choose one of the following options. Use the control wheel to scroll to the name of the file that is to be restored.
6. Press **<Restore>** to start the process.
7. Wait for the confirmation screen to appear.
8. Press **<Continue>** to return to the **Main Menu**.

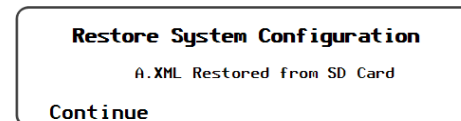
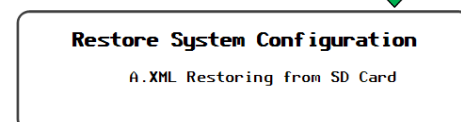
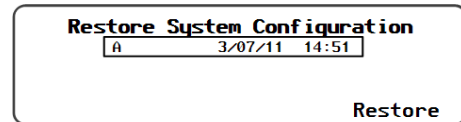
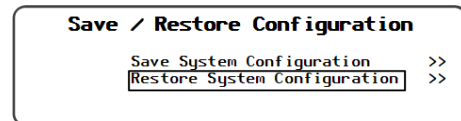
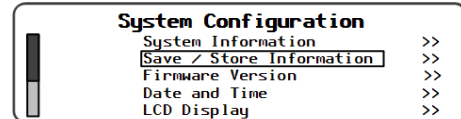
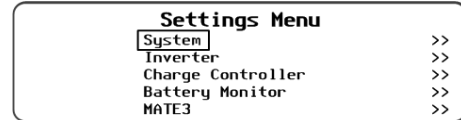
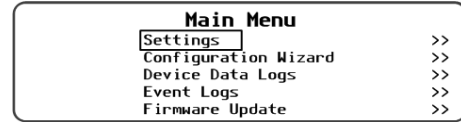

Press **<Continue>** to return to the **Main Menu**.

Figure 76 Restore System Configuration

Firmware Version

The **Firmware Versions** screen shows the current firmware versions for all the devices attached to the system. This is a read-only screen. No changes can be made from this screen.

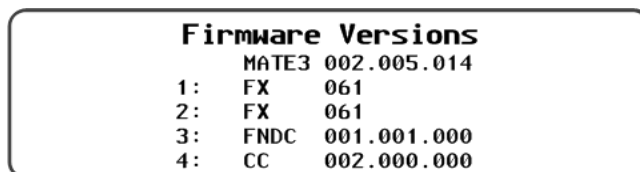

NOTE:

Firmware versions shown in this illustration are examples only. Actual versions may vary.

Figure 77 Firmware Version

Date and Time

The **Date and Time** screen allows the date and time to be set for the current date and current time.



IMPORTANT:

- Some features are dependent on time and date settings. Be sure to adjust these settings for the proper time and date for the location of the installation.
- The MATE3 clock does not automatically adjust for daylight savings time.
- The MATE3 **does** automatically adjust for leap year.

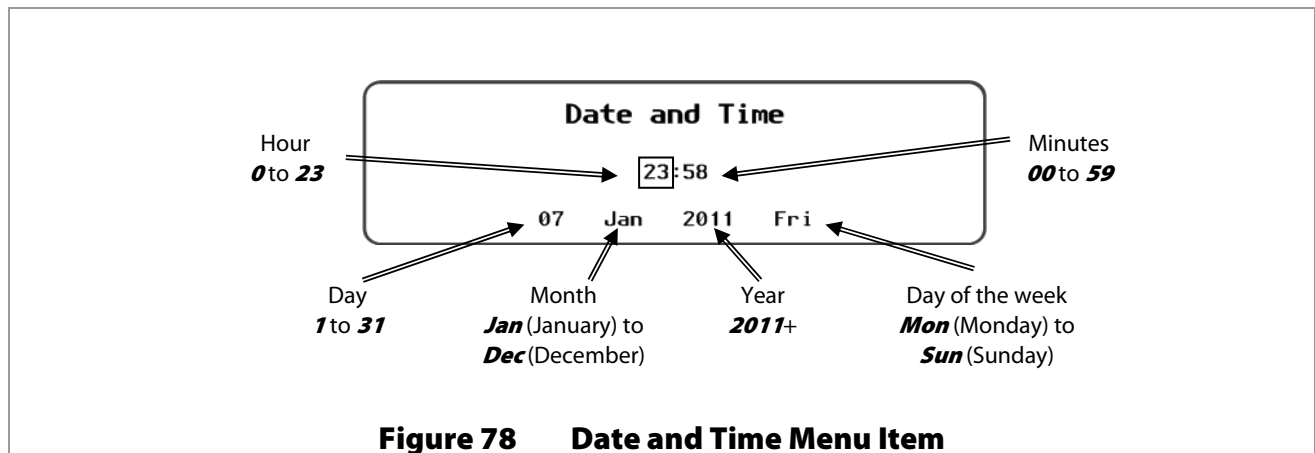

LCD Display

Ambient lighting and personal eyesight varies with every installation. Therefore, the contrast, color, brightness, backlighting, and auto timeout of the LCD can be adjusted to provide the best visibility for a given location.

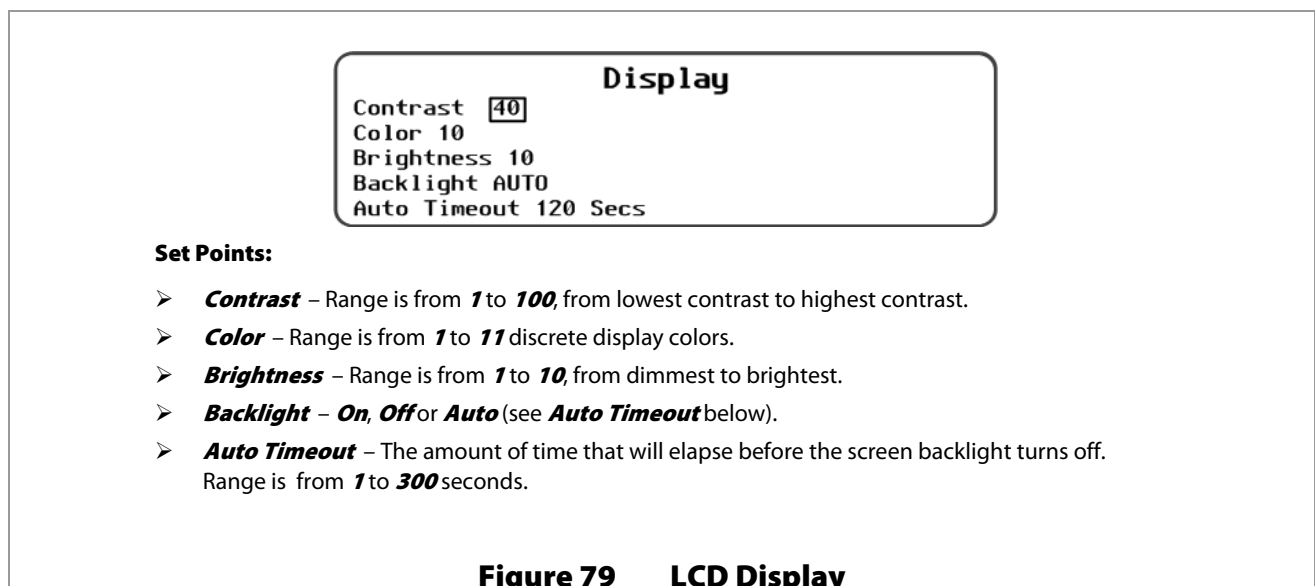

Sound

The Sound menu item allows the user to enable, or disable, sounds when a button is pushed or the control wheel is used.

Sound

Button Beep Enabled

Wheel Click Enabled

Set Points:

- **Button Beep** – Enabled or Disabled
- **Wheel Click** – Enabled or Disabled

Figure 80 Sound

Ethernet Addresses



IMPORTANT:

- Using this feature requires advanced knowledge of network administration and internet protocols. Due to the various types of routers available, specific instructions for setting up this feature will vary also.
- The IP address must be unique. It cannot be the same as any other device on the network.
- For additional information, see the Support section of the OutBack web site.

To connect the MATE3 to a personal computer or network, it may be necessary to manually set the IP address, netmask, gateway, DNS-1, and DNS-2 (optional) addresses to the host router.

Ethernet Addresses

DHCP Enabled	IP Address	192.168.000.064
	Netmask	255.255.255.000
	Gateway	192.168.000.001
	DNS-1	192.168.000.002
	DNS-2	192.168.000.003

Use for the following application:

- Connecting to a router on an Intranet. See page 24.

Set Points:

- **DHCP** (Dynamic Host Configuration Protocol) – **Enabled**. This allows the MATE3 to be assigned the IP address, netmask, gateway, DNS-1 and DNS-2 numbers from a router.

Ethernet Addresses

DHCP Disabled	IP Address	192.168.000.064
	Netmask	255.255.255.000
	Gateway	192.168.000.001
	DNS-1	192.168.000.002
	DNS-2	192.168.000.003

Use for the following applications:

- Connecting directly to a computer. See page 22.
- Connecting to a computer through a network switch. See page 23.
- Connecting to a computer to the MATE3 through the Internet. See page 26.

Set Points:

- **DHCP** (Dynamic Host Configuration Protocol) – **Disabled**. This allows the user to set the following parameters.
- **IP Address** – **192.168.xxx.xxx*** (Default IP address is 192.168.0.64)
- **Netmask** – **255.255.255.000***
- **Gateway** – **192.168.xxx.xx1***
- **DNS-1** – **192.168.xxx.xx2***
- **DNS-2** – **192.168.xxx.xx3***

(*this can vary by installation.)

Figure 81 Ethernet Addresses

Ethernet Ports

The MATE3 is preprogrammed to use the following ports for Ethernet communication. These ports are adjustable if required. See pages 24 through 28.

<div style="border: 1px solid black; padding: 5px; margin-bottom: 10px;"> <p style="text-align: center;">Ethernet Ports</p> <table style="width: 100%; border-collapse: collapse;"> <tr> <td style="width: 70%;">HTTP</td> <td style="border: 1px solid black; text-align: center;">80</td> </tr> <tr> <td>FTP</td> <td style="border: 1px solid black; text-align: center;">21</td> </tr> <tr> <td>Telnet</td> <td style="border: 1px solid black; text-align: center;">23</td> </tr> </table> </div>	HTTP	80	FTP	21	Telnet	23	<p>Set Points:</p> <ul style="list-style-type: none"> ➤ HTTP – Range 1 to 65535 (Default 80) ➤ FTP – Range 1 to 65535 (Default 21) ➤ Telnet – Range 1 to 65535 (Default 23)
HTTP	80						
FTP	21						
Telnet	23						

Figure 82 Ethernet Ports

Data Stream

Two choices are available for downloading information. Only one can be utilized at this time.

- Use the **Network Data Stream** option if the data is destined for a network server.
- The **Serial Data Stream** option is intended to send data to a personal computer. This feature is not usable at this time.

<div style="border: 1px solid black; padding: 5px; margin-bottom: 10px;"> <p style="text-align: center;">Data Stream</p> <table style="width: 100%; border-collapse: collapse;"> <tr> <td style="width: 70%;">Serial Data Stream</td> <td style="border: 1px solid black; text-align: center;">Disabled</td> </tr> <tr> <td>Serial Baud Rate</td> <td style="border: 1px solid black; text-align: center;">19200</td> </tr> <tr> <td>Network Data Stream</td> <td style="border: 1px solid black; text-align: center;">Disabled</td> </tr> <tr> <td>Destination IP</td> <td style="border: 1px solid black; text-align: center;">192.168.000.080</td> </tr> <tr> <td>Destination Port</td> <td style="border: 1px solid black; text-align: center;">57027</td> </tr> </table> </div>	Serial Data Stream	Disabled	Serial Baud Rate	19200	Network Data Stream	Disabled	Destination IP	192.168.000.080	Destination Port	57027	<p>Set Points:</p> <ul style="list-style-type: none"> ➤ For connecting to a personal computer: <ul style="list-style-type: none"> ~ Serial Data Stream – Enabled or Disabled ~ Serial Baud Rate – 9600, 19200, 34800, or 57600 ➤ For connecting to a network server: <ul style="list-style-type: none"> ~ Network Data Stream – Enabled or Disabled ~ Destination IP – The IP address of the host computer or server. ~ Destination Port – The port number assigned to the MATE3 on the host computer or server.
Serial Data Stream	Disabled										
Serial Baud Rate	19200										
Network Data Stream	Disabled										
Destination IP	192.168.000.080										
Destination Port	57027										

Figure 83 Data Stream Screen

System Name

The **System Name** screen allows the installer to give the installation a unique name and status title.

<div style="border: 1px solid black; padding: 5px; margin-bottom: 10px;"> <p style="text-align: center;">System Name</p> <table style="width: 100%; border-collapse: collapse;"> <tr> <td style="width: 70%;">Name</td> <td style="border: 1px solid black; text-align: center;">OutBack Power Technologies</td> </tr> <tr> <td>Status Title</td> <td style="border: 1px solid black; text-align: center;">OutBack Power</td> </tr> </table> </div>	Name	OutBack Power Technologies	Status Title	OutBack Power	<p>Set Points:</p> <ul style="list-style-type: none"> ➤ Name – Any combination of characters up to 30 characters maximum. This information is displayed by the web site interface (if used). ➤ Status Title – (Optional) Any combination of characters up to 15 characters maximum. This name is displayed on the Home screen.
Name	OutBack Power Technologies				
Status Title	OutBack Power				

Figure 84 System Name

Installer Information

The **Installer Information** screen allows a location to enter basic installer information.

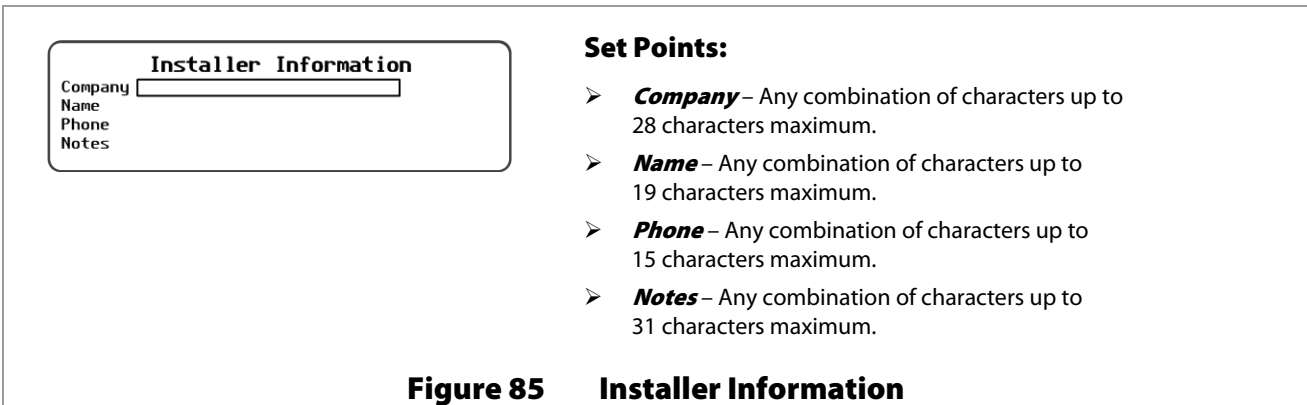

Installer Settings

The **Installer Settings** menu provides the ability to:

- **Set User Access Level**, preventing unauthorized access to certain levels of menus,
- **Change Installer Password**, allowing an installer access to the full menus, or to
- **Challenge Installer Password**, in case the installer password is lost.

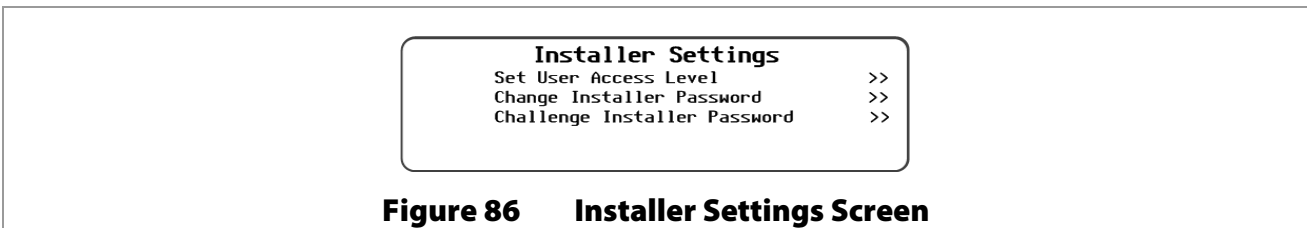

Set User Access Level

The **Set User Access Level** menu allows four different user access levels (UALs) to set points for programming.

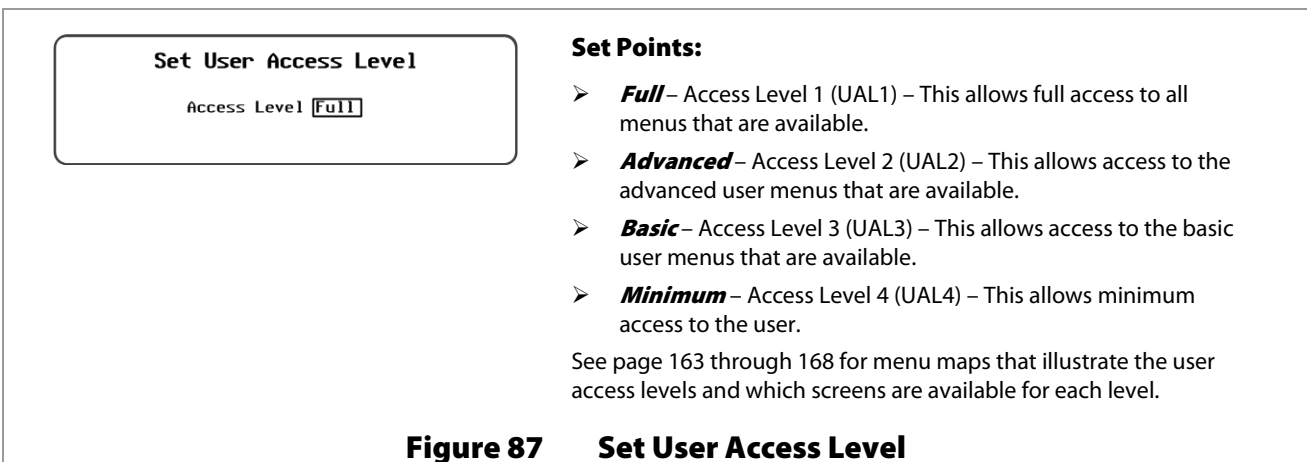

Change Installer Password

The **Change Installer Password** screen allows changes to the installer password so that access to the full menus can be restricted to those who know the new password (OEMs or installers).

	<p>IMPORTANT:</p> <p>Changes to system settings should only be made by qualified personnel or under the direction of OutBack Technical Support.</p>
---	--

<div style="border: 1px solid black; padding: 10px; width: fit-content; margin: auto;"> <p>Change Installer Password</p> <p>[0][7][3][2]</p> </div>	<p>Set Points:</p> <ul style="list-style-type: none"> ➤ Set points include four numerical digits from 0 to 9. ➤ The default installer password is 1732.
--	---

Figure 88 Change Installer Password

Challenge Installer Password

If the installer password is lost or forgotten, this process is used to reset access to the device. The screen will generate a challenge code as shown below. Once the installer has the challenge code, it is necessary to contact OutBack Technical Support (*see inside front cover*) to obtain a temporary “challenge password” that corresponds with the MATE3-generated challenge code. After entering a valid challenge password, the MATE3 will immediately display the **Change Installer Password** screen. The installer should change the password according to their preferences.

<div style="border: 1px solid black; padding: 10px; width: fit-content; margin: auto;"> <p>Challenge Installer Password</p> <p>[0][01][0][0]</p> <p>Challenge Code 8941</p> </div>	<p>Set Points:</p> <ul style="list-style-type: none"> ➤ Set points include four numerical digits from 0 to 9.
---	---

Figure 89 Challenge Installer Password

Inverter Settings

Many of the inverter settings in this section apply to both FX-class and Radian-class inverter/chargers. However, some screens and programming items are very different between these two types of inverters. In some cases where the screens are different, illustrations of each are provided. The title of the illustration indicates “FX-class” or “Radian-class”. In certain cases, the screens are so different that they are described on separate pages with the appropriate titles.

Inverter menu options include the following:

- **Search**-----> See below.
- **AC Input and Current Limit**-----> See below.
- **Grid AC Input Voltage Limits (FX-class)**-----> See page 85.
- **Gen AC Input Voltage Limits (FX-class)**-----> See page 85.
- **Grid AC Input Mode and Limits (Radian-class)**-----> See page 86
- **Gen AC Input Mode and Limits (Radian-class)**-----> See page 87.
- **AC Output**-----> See page 85.
- **Low Battery**-----> See page 88.
- **Battery Charger**-----> See page 89.
- **Battery Equalize**-----> See page 89.
- **Auxiliary Output**-----> See page 90.
- **Auxiliary Relay (Radian-class)**-----> See page 96.
- **Inverter Stacking**-----> See page 99.
- **Grid-Tie Sell**-----> See page 101.
- **Calibrate**-----> See page 102.
- **Reset Inverter to Factory Defaults**-----> See page 103.

Search Menu

This menu adjusts the inverter’s search circuit, which minimizes power draw when no loads are present. See the inverter *Operator’s Manual* for more information on the Search function.

Search

Port 1

Sensitivity **6**

Pulse Length 8 cycles

Pulse Spacing 60 cycles

Set Points:

- **Sensitivity** – Adjusts the Search mode sensitivity while searching for loads. Setting this item to zero will disable Search mode.
- **Pulse length** – Adjusts the duration of each search pulse (in single AC cycles). A longer duration means inverter detects a load more quickly. It also consumes more power.
- **Pulse spacing** – Adjusts the time between search pulses (in single AC cycles). Shorter spacing means the inverter detects a load more quickly. It also consumes more power.

Figure 90 Search Screen

AC Input and Current Limit

This menu controls the amount of current that the inverter can draw from the source(s). The menu has independent settings for two different AC sources. In the most common applications, one source is the utility grid and the other is an AC generator. The settings are labeled accordingly.

NOTE: An FX-class inverter has different interactions with multiple AC sources than a Radian-class inverter. For more information, see Figure 91, and see the *Installation Manual* for that model of inverter.

These settings should be adjusted to match the size of the input circuit breaker or input conductor. This is intended to protect a generator or source that may not be large enough to supply enough current. If the combined charging and loads exceed this setting, the inverter will reduce its charge rate and give priority to the loads.

If the loads exceed the limit on their own, the charge rate will be reduced to zero. This setting may be assisted by the Input Support function, if present in the inverter. (If present, see the inverter *Operator's Manual* for information about this function.)

If the loads still exceed this setting, the input breaker may trip. The unit will display an event with the following warning **Input Amps > Max.**

This menu has an independent current setting for the inverter's battery charger.

If multiple parallel inverters are installed with an AC source of limited wattage, the total combined amperage settings for all units must be less than the AC input circuit. The Configuration Wizard in the MATE3 can perform this calculation. See the inverter *Operator's Manual* for more information on managing input current.

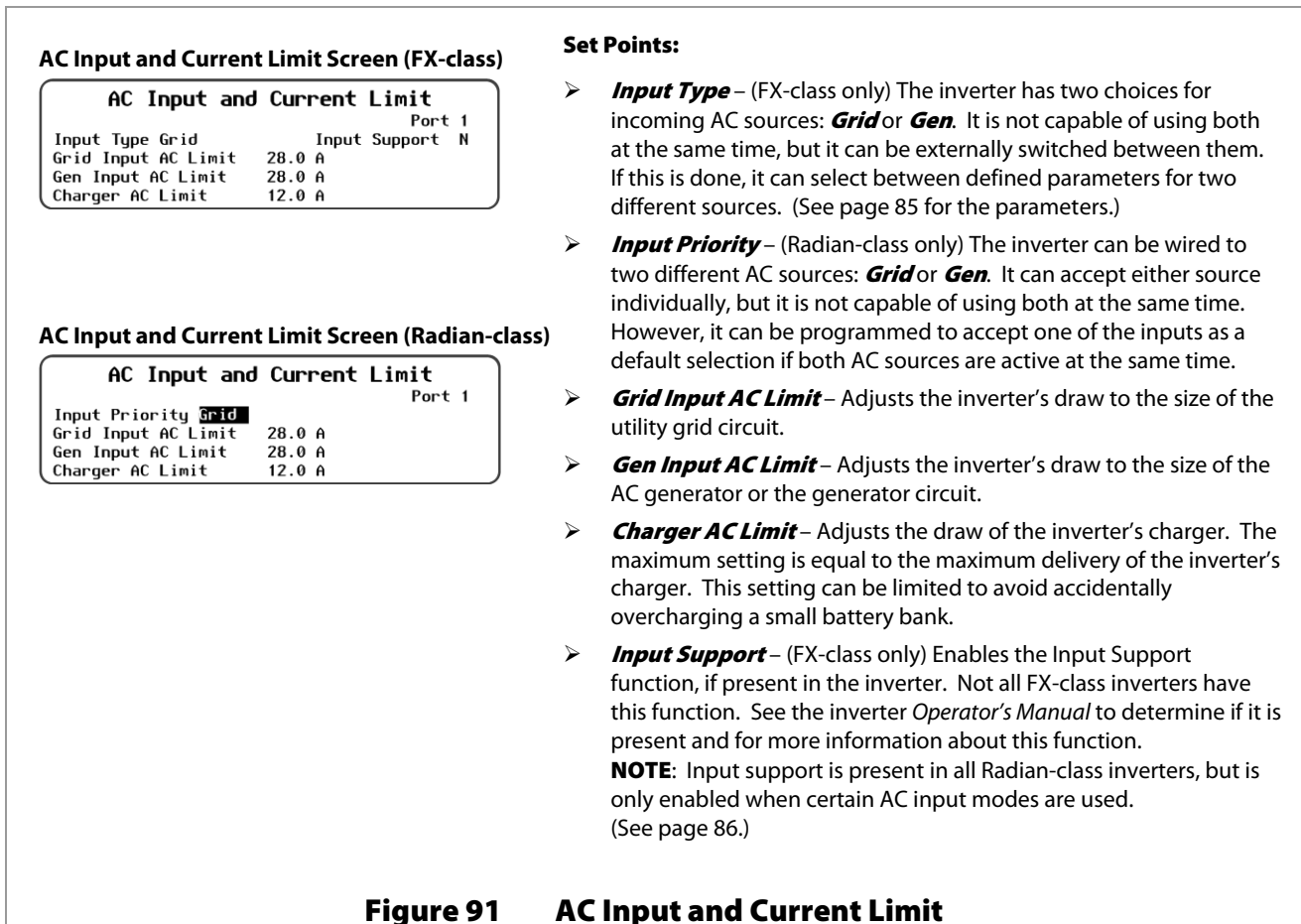

NOTE:

In FX-class grid-interactive inverters, **Input Type** also controls the cycle used by the inverter's battery charger. This overrides the selections offered in the **Charger Status** screen. (See page 56.)

- **Grid** selects a charge cycle consisting of bulk, absorption, and float stages. Upon completion, the charger goes into Silent mode until it reaches the "re-float" voltage, when it will re-enter the float stage.
- **Gen** selects a charge cycle consisting of bulk, absorption and float stages. Upon completion, the charger remains in the float stage to maintain the batteries until the AC input is disconnected.



IMPORTANT:

The **Input Type** selection also controls other AC source parameters, as described in the inverter *Operator's Manual*. If **Gen** is selected, a grid-interactive inverter will not sell power. However, the AGS function (see page 116) will function even if **Grid** is selected.

The above material does not apply to Radian-class inverters, or to FX-class inverters without grid-interactive functions.



IMPORTANT:

Selecting the charge cycle does not automatically activate the charger. If the charger is deactivated, it must still be activated using the **Charger Status** screen. (See page 56.)

Grid AC Input Voltage Limits (FX-class only)

The inverter will not connect to an AC source unless specific conditions are met. When **Input Type** is set to **Grid** in the **AC Input Current Limit** screen (Figure 91 on page 83), this menu adjusts the limits on acceptable voltage for the utility grid. (Frequency is not adjustable.) These limits will vary with the inverter model. See the inverter *Operator's Manual* for specific acceptance limits.

When the acceptance conditions are met, the inverter will accept the source after a delay of approximately 15 seconds.

Grid AC Input Voltage Limits
Port 1

Lower Voltage Limit **108** VAC
Upper Voltage Limit 140 VAC
Transfer Delay 6 Cycles

Set Points:

- **Lower Voltage Limit** – Sets the low limit on the acceptable AC voltage. If the source is above this voltage, the inverter will accept it. If it drops below this voltage, the inverter will return to inverting if the inverter is active.
- **Upper Voltage Limit** – Sets the high limit on the acceptable AC voltage. If the source is below this voltage, the inverter will accept it. If it rises above this voltage, the inverter will return to inverting if the inverter is active.
- **Transfer Delay** – Sets the duration that the input AC voltage or frequency may exceed limits before the inverter disconnects itself. This may be preceded by a warning (see page 42), and may be followed by a **Last AC Disconnect** message (see page 62).

Figure 92 Grid AC Input Voltage Limits (FX-class)

Gen AC Input Voltage Limits (FX-class only)

The inverter will not connect to an AC source unless specific conditions are met. When **Input Type** is set to **Gen** in the **AC Input Current Limit** screen (Figure 91 on page 83), this menu adjusts the limits on acceptable voltage for a generator. (Frequency is not adjustable.) These limits will vary with the inverter model. Check the inverter *Operator's Manual* for specific acceptance limits.

When the acceptance conditions are met, the inverter will accept the generator after the designated delay period (see below).

Gen AC Input Voltage Limits
Port 1

Lower Voltage Limit **108** VAC
Upper Voltage Limit 140 VAC
Transfer Delay 6 Cycles
Connect Delay 0.5 minutes

Set Points:

- **Lower Voltage Limit** – Sets the low limit on the acceptable AC voltage. If the source is above this voltage, the inverter will accept it. If it drops below this voltage, the inverter will disconnect itself. It will return to inverting if the inverter is active.
- **Upper Voltage Limit** – Sets the high limit on the acceptable AC voltage. If the source is below this voltage, the inverter will accept it. If it rises above this voltage, the inverter will disconnect itself. It will return to inverting if the inverter is active.
- **Transfer Delay** – Sets the duration that the input AC voltage or frequency may exceed limits before the inverter disconnects itself. This may be preceded by a warning (see page 42).
- **Connect Delay** – Sets the designated delay period before the inverter begins accepting power from the generator. This is intended to give the generator time to stabilize its output. It is not the same as the warmup period used by the AGS function (see page 116).

Figure 93 Gen AC Input Voltage Limits (FX-class)

Grid AC Input Mode and Limits (Radian-class only)

The inverter will not connect to an AC source unless specific conditions are met. This menu adjusts the limits on the Radian input with terminals labeled “GRID”. (This label is applied for convenience. The input may accept other sources.) See the *Radian Series Inverter/Charger Operator’s Manual* for more information, as well as specific acceptance limits.

When the acceptance conditions are met, the inverter will accept the source after the designated delay period (see below).

Grid AC Input Mode and Limits
Port 1

Input Mode **Grid Tied**
Voltage Limit Lower 108 VAC Upper 132 VAC
Transfer Delay 6 Cycles
Connect Delay 0.2 Minutes

Input Mode:

- **Generator**
- **Support**
- **Grid Tied**
- **UPS**
- **Backup**
- **Mini Grid**

Set Points:

- **Input Mode** – Sets this input to one of six AC input modes. Each input mode has specific advantages for a particular application. See the *Radian Series Inverter/Charger Operator’s Manual* for more information on each mode.
- **Voltage Limit Lower** – Sets the low limit on the acceptable AC voltage. If the source is above this point, the inverter will accept it. If it drops below this voltage, the inverter will disconnect itself. It will return to inverting if the inverter is active.
- **(Voltage Limit) Upper** – Sets the high limit on the acceptable AC voltage. If the source is below this point, the inverter will accept it. If it rises above this voltage, the inverter will disconnect itself. It will return to inverting if the inverter is active.
- **Transfer Delay** – Sets the duration that the input AC voltage or frequency may exceed limits before the inverter disconnects itself. This may be preceded by a warning (see page 42), and may be followed by a **Last AC Disconnect** message (see page 62).
- **Connect Delay** – Sets the designated delay period before the inverter begins accepting power from the source. This is intended to give a generator time to stabilize its output. It is not the same as the warmup period used by the AGS function (see page 116).

Figure 94 Grid AC Input Mode and Limits (Radian-class)

Gen AC Input Mode and Limits (Radian-class only)

The inverter will not connect to an AC source unless specific conditions are met. This menu adjusts the limits on the Radian input with terminals labeled “GEN”. (This label is applied for convenience. The input may accept other sources.) See the *Radian Series Inverter/Charger Operator’s Manual* for more information, as well as specific acceptance limits.

When the acceptance conditions are met, the inverter will accept the source after the designated delay period (see below).

Gen AC Input Mode and Limits
Port 1

Input Mode **Backup**
Voltage Limit Lower 108 VAC Upper 140 VAC
Transfer Delay 6 Cycles
Connect Delay 0.5 Minutes

Set Points:

- **Input Mode** – Sets this input to one of six AC input modes. Each input mode has specific advantages for a particular application. See the *Radian Series Inverter/Charger Operator’s Manual* for more information on each mode.
- **Voltage Limit Lower** – Sets the low limit on the acceptable AC voltage. If the source is above this point, the inverter will accept it. If it drops below this voltage, the inverter will disconnect itself. It will return to inverting if the inverter is active.
- **(Voltage Limit) Upper** – Sets the high limit on the acceptable AC voltage. If the source is below this point, the inverter will accept it. If it rises above this voltage, the inverter will disconnect itself. It will return to inverting if the inverter is active.
- **Transfer Delay** – Sets the duration that the input AC voltage or frequency may exceed limits before the inverter disconnects itself. This may be preceded by a warning (see page 42), and may be followed by a **Last AC Disconnect** message (see page 62).
- **Connect Delay** – Sets the designated delay period before the inverter begins accepting power from the source. This is intended to give a generator time to stabilize its output. It is not the same as the warmup period used by the AGS function (see page 116).

Input Mode:

- **Generator**
- **Support**
- **Grid Tied**
- **UPS**
- **Backup**
- **Mini Grid**

Figure 95 Gen AC Input Mode and Limits (Radian-class)

AC Output

This menu adjusts the output voltage produced while the inverter is inverting (running on battery power). This setting does not affect the output when using another AC input source. It does not affect the acceptance parameters for an AC input source. The range of adjustability will vary with inverter model. See the inverter *Operator's Manual* for the specific range of adjustability.

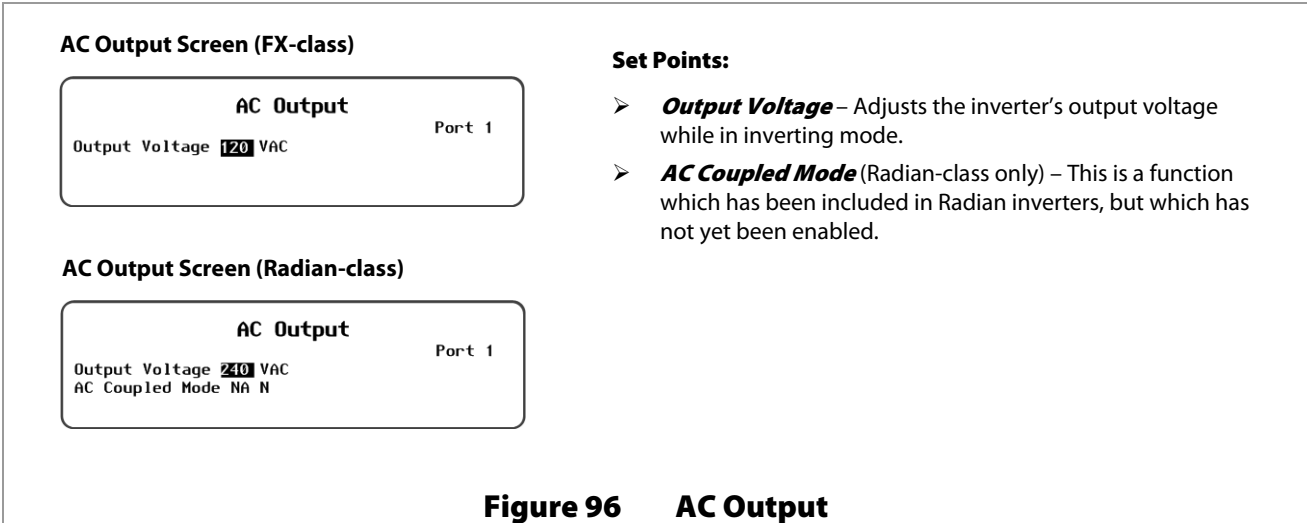

Low Battery

While inverting, the inverter will not be able to sustain its operation if the battery voltage goes below a certain point. The inverter will stop functioning and generate an error. This function is referred to as a Low Battery Cut-Out (LBCO). The function is intended to protect the batteries, as excessive discharge may damage a battery. It also protects the inverter’s output and loads. Continuing to invert on a low DC voltage may produce a distorted waveform.

When this occurs, the Events LED will illuminate to indicate an event has occurred. (See Figure 159 on page 151 for reviewing event details.)

The range of adjustability for this set point will vary with inverter model. See the inverter *Operator's Manual* for the specific range of adjustability.

The inverter will also stop functioning and give an error due to high battery voltage. However, the high-battery cut-out voltage is not adjustable.

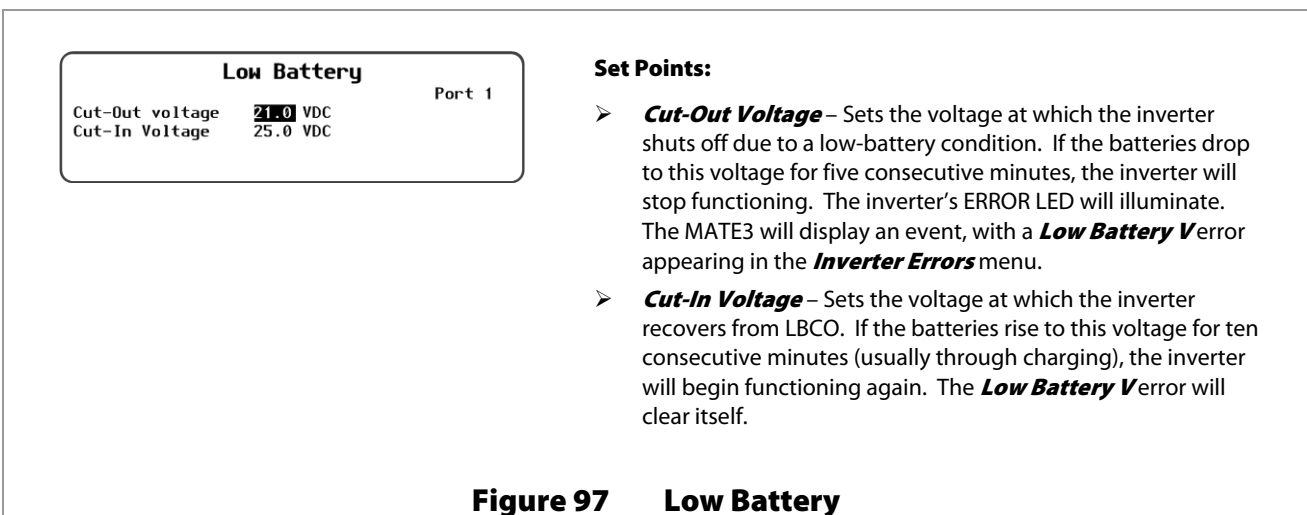

Battery Charger



IMPORTANT:

Battery charger settings need to be correct for a given battery type. Always follow battery manufacturer recommendations. Making incorrect settings, or leaving them at factory default settings, may cause the batteries to be undercharged or overcharged.

The inverter uses a “three-stage” battery charging cycle which utilizes multiple settings. This menu controls the voltages and timers for the battery charger. See the inverter *Operator’s Manual* for an explanation of the three-stage cycle and a description of the individual stages.

In a grid-interactive model, the Sell voltage setting is used as part of the charging cycle. The Sell voltage is not accessible here, but is settable in the **Grid-Tie Sell** menu (see page 101). The Equalize settings are also not accessible here, but are settable in the **Battery Equalize** menu (see page 89).

<div style="border: 1px solid black; padding: 5px; margin-bottom: 10px;"> <p style="text-align: center;">Battery Charger</p> <table style="width: 100%; border-collapse: collapse;"> <tr> <td style="width: 60%;">Absorb Voltage</td> <td style="width: 20%; text-align: right;">29.2 VDC</td> <td style="width: 20%; text-align: right;">Time 1.0</td> <td style="width: 10%; text-align: right;">Port 1</td> </tr> <tr> <td>Float Voltage</td> <td style="text-align: right;">26.8 VDC</td> <td style="text-align: right;">Time 1.0</td> <td></td> </tr> <tr> <td>Re-Float Voltage</td> <td style="text-align: right;">25.0 VDC</td> <td></td> <td></td> </tr> </table> </div>	Absorb Voltage	29.2 VDC	Time 1.0	Port 1	Float Voltage	26.8 VDC	Time 1.0		Re-Float Voltage	25.0 VDC			<p>Set Points:</p> <ul style="list-style-type: none"> ➤ Absorb Voltage – Adjusts the target voltage of Bulk and Absorption stages. ➤ (Absorb) Time – Adjusts the duration of the Absorption stage. ➤ Float Voltage – Adjusts the target voltage of the Float stage. ➤ (Float) Time – Adjusts the duration of the Float stage, once the voltage has been reached. ➤ Re-Float Voltage – Adjusts the point at which the Float stage begins again.
Absorb Voltage	29.2 VDC	Time 1.0	Port 1										
Float Voltage	26.8 VDC	Time 1.0											
Re-Float Voltage	25.0 VDC												

Figure 98 Battery Charger

Battery Equalize



CAUTION: Battery Damage

- Do not equalize any sealed battery types (VRLA, AGM, Gel, or other) unless approved by the manufacturer. Some batteries may suffer severe damage from equalization.
- Contact the battery manufacturer for recommendations on equalization voltage, duration, schedule, and/or advisability. Always follow manufacturer recommendations for equalization.

The Battery Equalize menu controls the settings for the equalization process, which is used for battery maintenance. See the inverter *Operator’s Manual* for an explanation of equalization and how it relates to the regular charging process.

<div style="border: 1px solid black; padding: 5px; margin-bottom: 10px;"> <p style="text-align: center;">Battery Equalize</p> <table style="width: 100%; border-collapse: collapse;"> <tr> <td style="width: 60%;">Equalize Voltage</td> <td style="width: 20%; text-align: right;">31.0 VDC</td> <td style="width: 20%; text-align: right;">Time 1.0</td> <td style="width: 10%; text-align: right;">Port 1</td> </tr> </table> </div>	Equalize Voltage	31.0 VDC	Time 1.0	Port 1	<p>Set Points:</p> <ul style="list-style-type: none"> ➤ Equalize Voltage – Adjusts the voltage of the Equalization cycle. ➤ (Equalize) Time – Adjusts the duration of the Equalization cycle, once the voltage has been reached.
Equalize Voltage	31.0 VDC	Time 1.0	Port 1		

Figure 99 Battery Equalize

Auxiliary Output (AUX Modes, FX-class only)

The **Auxiliary Output** menu controls the functionality of an FX-class inverter's Auxiliary (AUX) output. The inverter's AUX terminals provide a 12 Vdc output that can deliver up to 0.7 Adc to control external loads. Typical loads include signaling a generator to start, sending a fault alarm signal, or running a small fan to cool the inverter. See the inverter *Installation Manual* for more information on hooking up the AUX terminals.

Auxiliary Output Screen (FX-class)

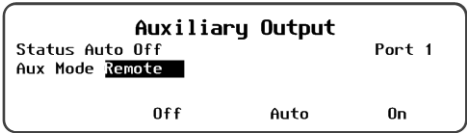

Aux Modes:

- **Remote**
- **Load Shed**
- **Gen Alert**
- **Fault**
- **Vent Fan**
- **Cool Fan**
- **Divert DC**
- **Divert AC**
- **AC Drop**

Set Points:

- **Status** – The AUX output status is controlled by the **<Off>**, **<Auto>**, and **<On>** soft keys.
 - ~ **<On>** activates the **Auxiliary Output** immediately. It will display the message **Manual On** and remain continuously active until **<Off>** is selected.
 - ~ **<Auto>** activates the **Auxiliary Output** by automatic criteria, according to the option selected in **Aux Mode**. When activated, it displays the message **Auto On**; otherwise it displays **Auto Off**.
 - ~ **<Off>** deactivates the **Auxiliary Output** and prevents any of the inverter's automatic AUX options from working. When **<Off>** is selected, it will display **Manual Off**. Note that even if the AUX output is set to **Off**, it may still be activated by an external option not based in the inverter, such as AGS. (See page 115.) If this soft key is pressed, the screen will display **Manual Off**.
- **Aux Mode** – Selects one of nine options with automatic criteria. (These options are described briefly in the next section and in greater detail in the inverter *Operator's Manual*.)

NOTE: If an **Aux Mode** has settable parameters, additional fields will appear below this item showing the options.

Figure 100 Auxiliary Output

Auxiliary modes include the following:

- **Remote** allows the AUX output to be activated in response to manual or automatic commands external to the inverter, such as the MATE3's AGS function. It is strongly recommended to select **Remote** when the AUX output is controlled by AGS or similar external functions. This will prevent software conflicts. This function has no settable parameters.
- **Load Shed** performs load management. The AUX output activates when DC (battery) voltage drops below a certain level. The AUX output operates a larger relay, which turns noncritical loads on or off to conserve battery power. (See the inverter *Operator's Manual* for other criteria that will activate this function.) The AUX output remains active for three minutes after removing the condition that activated it.
 - This function has a settable DC voltage parameter.

Auxiliary Output

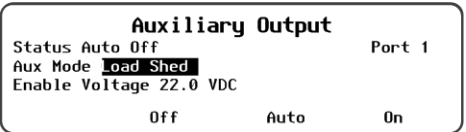

Set Point:

- **Enable Voltage** – Sets the low-voltage level at which the Load Shed function activates the AUX output.

Figure 101 Load Shed

- **Gen Alert** can be used as a limited functionality controller for an AC generator with a remote start feature. It can start and stop the generator based on DC (battery) voltage levels.

➤ This function has settable DC voltage and time parameters.

NOTE: This function does not have the same advantages as the Advanced Generator Start (AGS) function which is controlled directly by the MATE3. (See page 115.)

Auxiliary Output			
Status	Auto	Off	Port 1
Aux Mode	Gen Alert		
ON: Voltage	22.0 VDC	Delay	4 Minutes
OFF: Voltage	28.0 VDC	Delay	9 Minutes
	Off	Auto	On

Set Points:

- **ON: Voltage** – Sets the low-voltage level at which the **Gen Alert** function activates the AUX output.
- **Delay** – Sets the delay time after the **ON: Voltage** setting is reached before the AUX output is activated.
- **OFF: Voltage** – Sets the high-voltage level at which the **Gen Alert** function deactivates the AUX output.
- **Delay** – Sets the delay time after the **OFF: Voltage** setting is reached before the AUX output is deactivated.

Figure 102 Gen Alert

- **Fault** activates the AUX output when the inverter shuts down due to an error condition (see page 43). It can operate a light or alarm to show that the inverter has failed. This function has no settable parameters.

- **Vent Fan** activates the AUX output in response to high DC (battery) voltage. It can operate a small fan to ventilate the battery compartment to eliminate gases that result from battery charging.

➤ This function has settable DC voltage and time parameters.

Auxiliary Output			
Status	Auto	Off	Port 1
Aux Mode	Vent Fan		
Enable Voltage	26.0 VDC		
Off Period	5 Minutes		
	Off	Auto	On

Set Points:

- **Enable Voltage** – Sets the high-voltage level at which the function activates the AUX output. It remains active for one minute.
- **OFF Period** – Sets the delay time before the function activates the AUX output again.

Figure 103 Vent Fan

- **Cool Fan** activates the AUX output when the inverter reaches a high internal temperature. It is intended to operate a small external fan for additional cooling. This includes sealed inverter models which come with a Turbo fan. This function has no settable parameters.

- **Divert DC** activates the AUX output to divert excess energy to a DC load, in response to high DC (battery) voltage. The AUX output controls a larger relay, which allows current to flow to a dedicated DC load when energized.

➤ This function has settable DC voltage and time parameters.

Auxiliary Output			
Status	Auto	Off	Port 1
Aux Mode	Divert DC		
Enable Voltage	29.2 VDC		
Off Delay	30 Minutes		
	Off	Auto	On

Set Points:

- **Enable Voltage** – Sets the high-voltage level at which the **Divert DC** function activates the AUX output. It remains active as long as the voltage remains above this set point.
- **OFF Delay** – Prevents the AUX output from activating again for a certain amount of time, even if the voltage rises above the **Enable Voltage** set point again. This prevents nuisance cycling of the **Divert DC** function.

Figure 104 Divert DC

Programming

- **Divert AC** activates the AUX output to divert excess renewable energy to an AC load powered by the inverter, in response to high DC (battery) voltage. The AUX output operates a larger relay, which allows current to flow from the batteries to a dedicated AC load when energized.

NOTE:

- ~ If the inverter load exceeds the system amperage limit, the AUX output will deactivate to prevent an overload condition.
- ~ During variable conditions, the AUX output is activated no more than once per minute. This prevents rapid nuisance cycling of the AC load in the event of rapidly changing battery conditions.
- ➔ This function has settable DC voltage and time parameters.

Auxiliary Output		Port 1
Status	Auto Off	
Aux Mode	Divert AC	
Enable Voltage	29.2 VDC	
Off Delay	30 Minutes	
	Off	Auto On

Set Points:

- **Enable Voltage** – Sets the high-voltage level at which the **Divert AC** function activates the AUX output. It remains active as long as the voltage remains above this set point.
- **OFF Delay** – Prevents the AUX output from activating again for a certain amount of time, even if the voltage rises above the **Enable Voltage** set point again. This prevents nuisance cycling of the **Divert AC** function.

Figure 105 Divert AC

- **AC Drop** activates the AUX output whenever the inverter disconnects from an AC source. It can operate a light (or alarm) to show that the utility grid has failed or that a generator has shut off. This menu has no adjustable settings.

Auxiliary Output (AUX Modes, Radian-class only)

The **Auxiliary Output** controls the functionality of a Radian-class inverter’s Auxiliary (AUX) output. The inverter’s AUX terminals provide a 12 Vdc output that can deliver up to 0.7 Adc to control external loads. Typical loads include signaling a generator to start, sending a fault alarm signal, or running a small fan to cool the inverter. See the inverter *Installation Manual* for more information on hooking up the AUX terminals.

NOTE: The Radian inverter is equipped with two sets of AUX terminals: Auxiliary Output and Auxiliary Relay, each with its own menu. These menus control the output and functionality of the AUX output.

Auxiliary Output Screen (Radian-class)

Auxiliary Output

Status Auto Off Port 1

Aux Mode **Fault**

Off Auto On

Aux Modes:

- **Load Shed**
- **Gen Alert**
- **Fault**
- **Vent Fan**
- **Cool Fan**
- **DC Divert**
- **IEEE**
- **Source Status**
- **AC Divert**

Set Points:

- **Status** – The AUX output status is controlled by the **<Off>**, **<Auto>**, and **<On>** soft keys.
 - ~ **<On>** activates the **Auxiliary Output** immediately. It will display the message **Manual On** and remain continuously active until **<Off>** is selected.
 - ~ **<Auto>** activates the **Auxiliary Output** by automatic criteria, according to the option selected in **Aux Mode**. When activated, it displays the message **Auto On**; otherwise it displays **Auto Off**.
 - ~ **<Off>** deactivates the **Auxiliary Output** and prevents any of the inverter’s automatic AUX options from working. When **<Off>** is selected, it will display **Manual Off**. Note that even if the AUX output is set to **Off**, it may still be activated by an external option not based in the inverter, such as AGS. (See page 115.) If this soft key is pressed, the screen will display **Manual Off**.
- **Aux Mode** – Selects one of nine functions with automatic criteria. (These functions are described briefly in the next section and in greater detail in the inverter *Operator’s Manual*.)

Figure 106 Auxiliary Output

Auxiliary modes include the following:

- **Load Shed** can perform load management. When battery voltage rises above a settable high voltage level, the AUX output is activated after a settable delay. The AUX output is used to operate a relay, which is connected to non-vital loads. The AUX output will be deactivated once the battery voltage falls below a low voltage setting for a settable delay period. See the *Operator’s Manual* for other conditions when this function may be deactivated.

➡ This function has settable DC voltage and time parameters.

Auxiliary Output

Status Auto Off Port 1

Aux Mode **Load Shed**

ON: Batt >	44.0 VDC	Delay	0.5 Mins
OFF: Batt <	56.0 VDC	Delay	0.5 Mins
	Off	Auto	On

Set Point:

- **ON: Batt** – Sets the high-voltage level at which the **Load Shed** function activates the AUX output.
- **Delay** – Sets the delay time after the **ON: Batt** setting is reached before the AUX output is activated.
- **OFF: Batt** – Sets the low-voltage level at which the **Load Shed** function deactivates the AUX output.
- **Delay** – Sets the delay time after the **OFF: Batt** setting is reached before the AUX output is deactivated.

Figure 107 Load Shed

Programming

- **Gen Alert** can be used as a limited-functionality controller for an AC generator with a remote-start feature. It can start and stop the generator based on DC (battery) voltage levels.
 - This function has settable DC voltage and time parameters.

NOTE: This option does not have the same advantages as the Advanced Generator Start (AGS) function which is controlled directly by the MATE3. (See page 115.)

Auxiliary Output		Port 1
Status	Auto Off	
Aux Mode	Gen Alert	
ON:	Batt < 44.0 VDC	Delay 0.5 Mins
OFF:	Batt > 56.0 VDC	Delay 0.5 Mins
	Off	Auto On

Set Points:

- **ON: Voltage** – Sets the low-voltage level at which the **Gen Alert** function activates the AUX output.
- **Delay** – Sets the delay time after the **ON: Voltage** setting is reached before the AUX output is activated.
- **OFF: Voltage** – Sets the high-voltage level at which the **Gen Alert** function deactivates the AUX output.
- **Delay** – Sets the delay time after the **OFF: Voltage** setting is reached before the AUX output is deactivated.

Figure 108 Gen Alert

- **Fault** activates the AUX output when the inverter shuts down due to an error condition (see page 43). It can operate a light or alarm to show that the inverter has failed. This function has no settable parameters. The screen is shown on page 93.
- **Vent Fan** activates the AUX output in response to high DC (battery) voltage. It can operate a small fan to ventilate the battery compartment to eliminate gases that result from battery charging.
 - This function has settable DC voltage and time parameters.

Auxiliary Output		Port 1
Status	Auto Off	
Aux Mode	Vent Fan	
ON:	Batt > 56.0 VDC	
OFF:	Delay 0.5 Mins	
	Off	Auto On

Set Points:

- **ON: Batt** – Sets the high-voltage level at which the function activates the AUX output. It remains active for one minute.
- **OFF: Delay** – Sets the delay time before the function activates the AUX output again.

Figure 109 Vent Fan

- **Cool Fan** activates the AUX output when the inverter reaches a high internal temperature. It is intended to operate a small external fan for additional cooling. This includes sealed inverter models which come with a Turbo fan. This function has no settable parameters. The AUX output deactivates after reaching a cooler temperature.
- **DC Divert** activates the AUX output to divert excess energy to a DC load, in response to high DC (battery) voltage. The AUX output operates a larger relay, which allows current to flow to a dedicated DC load when energized. The output deactivates following a delay when a low DC voltage setting is reached.
 - This option has settable DC voltage and time parameters.

Auxiliary Output		Port 1
Status	Auto Off	
Aux Mode	DC Divert	
ON:	Batt > 56.0 VDC	Delay 0.5 Mins
OFF:	Batt < 44.0 VDC	Delay 0.5 Mins
	Off	Auto On

Set Points:

- **ON: Batt** – Sets the high-voltage level at which the **DC Divert** function activates the AUX output.
- **Delay** – Sets the delay time after the **ON: Batt** setting is reached before the AUX output is activated.
- **OFF: Batt** – Sets the low-voltage level at which the **DC Divert** function deactivates the AUX output.
- **Delay** – Sets the delay time after the **OFF: Batt** setting is reached before the AUX output is deactivated.

Figure 110 Divert DC

- **IEEE** activates the AUX output as an alert that the utility grid does not meet IEEE parameters for the grid-interactive function (see page 101). It can operate a light or alarm to show that the grid-interactive function has shut down and that there may be problems with the grid. The AUX output will cycle on and off if IEEE parameters are met and the IEEE timer is counting down. This function has no settable parameters. The output deactivates if the timer has expired and normal parameters are met.
- **Source Status** activates the AUX output whenever the inverter accepts an AC source. It can operate a light or alarm to show that the utility grid is present or that a generator has started. Alternately, it could be used to show that the source has disconnected. This function has no settable parameters. The output deactivates if no AC source is present.
- **Divert AC** activates the AUX output to divert excess renewable energy to an AC load powered by the inverter, in response to high DC (battery) voltage. The AUX output controls a larger relay, which allows current to flow from the batteries to a dedicated AC load when energized. The output deactivates following a delay when a low DC voltage setting is reached. See the *Radian Operator's Manual* for other conditions when this function may be deactivated.

NOTE :

During variable conditions, the AUX output is activated no more than once per minute. This prevents rapid nuisance cycling of the AC load in the event of rapidly changing battery conditions.

➤ This function has settable DC voltage and time parameters.

<table border="1" style="width: 100%; border-collapse: collapse;"> <tr> <th colspan="4" style="text-align: center;">Auxiliary Output</th> </tr> <tr> <td>Status</td> <td>Auto</td> <td>Off</td> <td style="text-align: right;">Port 1</td> </tr> <tr> <td>Aux Mode</td> <td colspan="3">AC Divert</td> </tr> <tr> <td>ON: Batt</td> <td>></td> <td>56.0 VDC</td> <td>Delay 0.5 Mins</td> </tr> <tr> <td>OFF: Batt</td> <td><</td> <td>44.0 VDC</td> <td>Delay 0.5 Mins</td> </tr> <tr> <td></td> <td></td> <td>Off</td> <td>Auto On</td> </tr> </table>	Auxiliary Output				Status	Auto	Off	Port 1	Aux Mode	AC Divert			ON: Batt	>	56.0 VDC	Delay 0.5 Mins	OFF: Batt	<	44.0 VDC	Delay 0.5 Mins			Off	Auto On	<p>Set Points:</p> <ul style="list-style-type: none"> ➤ ON: Batt – Sets the high-voltage level at which the AC Divert function activates the AUX output. ➤ Delay – Sets the delay time after the ON: Batt setting is reached before the AUX output is activated. ➤ OFF: Batt – Sets the low-voltage level at which the AC Divert function deactivates the AUX output. ➤ Delay – Sets the delay time after the OFF: Batt setting is reached before the AUX output is deactivated.
Auxiliary Output																									
Status	Auto	Off	Port 1																						
Aux Mode	AC Divert																								
ON: Batt	>	56.0 VDC	Delay 0.5 Mins																						
OFF: Batt	<	44.0 VDC	Delay 0.5 Mins																						
		Off	Auto On																						

Figure 111 Divert AC

Auxiliary Relay (AUX Modes, Radian-class only)

The **Auxiliary Relay** controls the functionality of a Radian-class inverter’s Auxiliary (AUX) relay contacts. The inverter’s AUX relay provides a set of “dry” contacts which can be used as a switch to control external loads. Typical loads include signaling a generator to start, sending a fault alarm signal, or running a small fan to cool the inverter. See the inverter *Installation Manual* for more information on hooking up the AUX terminals.

NOTE: The Radian inverter is equipped with two sets of AUX terminals: Auxiliary Output and Auxiliary Relay, each with its own menu. These menus control the output and functionality of the AUX relay.

Auxiliary Relay Screen (Radian-class)

Auxiliary Relay

Status Auto Off Port 1

Aux Mode **Fault**

Off Auto On

Aux Modes:

- **Load Shed**
- **Gen Alert**
- **Fault**
- **Vent Fan**
- **Cool Fan**
- **DC Divert**
- **IEEE**
- **Source Status**
- **AC Divert**

Set Points:

- **Status** – The AUX relay status is controlled by the **<Off>**, **<Auto>**, and **<On>** soft keys.
 - ~ **<On>** activates the **Auxiliary Relay** immediately. It will display the message **Manual On** and remain continuously active until **<Off>** is selected.
 - ~ **<Auto>** activates the **Auxiliary Relay** by automatic criteria, according to the option selected in **Aux Mode**. When activated, it displays the message **Auto On**, otherwise it displays **Auto Off**.
 - ~ **<Off>** deactivates the **Auxiliary Relay** and prevents any of the inverter’s automatic AUX options from working. When **<Off>** is selected, it will display **Manual Off**. Note that even if the AUX relay is set to **Off**, it may still be activated by an external option not based in the inverter, such as AGS. (See page 115.) If this soft key is pressed, the screen will display **Manual Off**.
- **Aux Mode** – Selects one of nine functions with automatic criteria. (These functions are described briefly in the next section and in greater detail in the inverter *Operator’s Manual*.)

Figure 112 Auxiliary Output

Auxiliary modes include the following:

- **Load Shed** can perform load management. When battery voltage rises above a settable high voltage level, the AUX output is activated after a settable delay. The AUX output is used to operate a relay, which is connected to non-vital loads. The AUX output will be deactivated once the battery voltage falls below a low voltage setting for a settable delay period. See the *Operator’s Manual* for other conditions when this function may be deactivated.

➔ This function has settable DC voltage and time parameters.

Auxiliary Output

Status Auto Off Port 1

Aux Mode **Load Shed**

ON: Batt > 44.0 VDC Delay 0.5 Mins

OFF: Batt < 56.0 VDC Delay 0.5 Mins

Off Auto On

Set Point:

- **ON: Batt** – Sets the high-voltage level at which the **Load Shed** function activates the AUX output.
- **Delay** – Sets the delay time after the **ON: Batt** setting is reached before the AUX output is activated.
- **OFF: Batt** – Sets the low-voltage level at which the **Load Shed** function deactivates the AUX output.
- **Delay** – Sets the delay time after the **OFF: Batt** setting is reached before the AUX output is deactivated.

Figure 113 Load Shed

- **Gen Alert** can be used as a limited functionality controller for an AC generator with a remote start feature. It can start and stop the generator based on DC (battery) voltage levels.
 - This function has settable DC voltage and time parameters.

NOTE: This option does not have the same advantages as the Advanced Generator Start (AGS) function which is controlled directly by the MATE3. (See page 115.)

Auxiliary Output			
Status	Auto	Off	Port 1
Aux Mode	Gen Alert		
ON:	Batt < 44.0 VDC	Delay 0.5 Mins	
OFF:	Batt > 56.0 VDC	Delay 0.5 Mins	
	Off	Auto	On

Set Points:

- **ON: Voltage** – Sets the low-voltage level at which the **Gen Alert** function activates the AUX output.
- **Delay** – Sets the delay time after the **ON: Voltage** setting is reached before the AUX output is activated.
- **OFF: Voltage** – Sets the high-voltage level at which the **Gen Alert** function deactivates the AUX output.
- **Delay** – Sets the delay time after the **OFF: Voltage** setting is reached before the AUX output is deactivated.

Figure 114 Gen Alert

- **Fault** activates the AUX output when the inverter shuts down due to an error condition (see page 43). It can operate a light or alarm to show that the inverter has failed. This function has no settable parameters. The screen is shown in Figure 112 on page 96.
- **Vent Fan** activates the AUX output in response to high DC (battery) voltage. It can operate a small fan to ventilate the battery compartment to eliminate gases that result from battery charging.
 - This function has settable DC voltage and time parameters.

Auxiliary Output			
Status	Auto	Off	Port 1
Aux Mode	Vent Fan		
ON:	Batt > 56.0 VDC		
OFF:	Delay 0.5 Mins		
	Off	Auto	On

Set Points:

- **ON: Batt** – Sets the high-voltage level at which the function activates the AUX output. It remains active for one minute.
- **OFF: Delay** – Sets the delay time before the function activates the AUX output again.

Figure 115 Vent Fan

- **Cool Fan** activates the AUX output when the inverter reaches a high internal temperature. It is intended to operate a small external fan for additional cooling. This includes sealed inverter models which come with a Turbo fan. This function has no settable parameters. The AUX output deactivates after reaching a cooler temperature.
- **DC Divert** activates the AUX output to divert excess energy to a DC load, in response to high DC (battery) voltage. The AUX output operates a larger relay, which allows current to flow to a dedicated DC load when energized. The output deactivates following a delay when a low DC voltage setting is reached.
 - This option has settable DC voltage and time parameters.

Auxiliary Output			
Status	Auto	Off	Port 1
Aux Mode	DC Divert		
ON:	Batt > 56.0 VDC	Delay 0.5 Mins	
OFF:	Batt < 44.0 VDC	Delay 0.5 Mins	
	Off	Auto	On

Set Points:

- **ON: Batt** – Sets the high-voltage level at which the **DC Divert** function activates the AUX output.
- **Delay** – Sets the delay time after the **ON: Batt** setting is reached before the AUX output is activated.
- **OFF: Batt** – Sets the low-voltage level at which the **DC Divert** function deactivates the AUX output.
- **Delay** – Sets the delay time after the **OFF: Batt** setting is reached before the AUX output is deactivated.

Figure 116 Divert DC

Programming

- **IEEE** activates the AUX output as an alert that the utility grid does not meet IEEE parameters for the grid-interactive function (see page 101). It can operate a light or alarm to show that the grid-interactive function has shut down and that there may be problems with the grid. The AUX output will cycle on and off if IEEE parameters are met and the IEEE timer is counting down. This function has no settable parameters. The output deactivates if the timer has expired and normal parameters are met.
- **Source Status** activates the AUX output whenever the inverter accepts an AC source. It can operate a light or alarm to show that the utility grid is present or that a generator has started. Alternately, it could be used to show that the source has disconnected. This function has no settable parameters. The output deactivates if no AC source is present.
- **Divert AC** activates the AUX output to divert excess renewable energy to an AC load powered by the inverter, in response to high DC (battery) voltage. The AUX output operates a larger relay, which allows current to flow from the batteries to a dedicated AC load when energized. The output deactivates following a delay when a low DC voltage setting is reached. See the *Radian Operator's Manual* for other conditions when this function may be deactivated.

NOTE:

During variable conditions, the AUX output is activated no more than once per minute. This prevents rapid nuisance cycling of the AC load in the event of rapidly changing battery conditions.

- This function has settable DC voltage and time parameters.

Auxiliary Output				Port 1
Status	Auto	Off		
Aux Mode	AC Divert			
ON: Batt	>	56.0 VDC	Delay	0.5 Mins
OFF: Batt	<	44.0 VDC	Delay	0.5 Mins
		Off	Auto	On

Set Points:

- **ON: Batt** – Sets the high-voltage level at which the **AC Divert** function activates the AUX output.
- **Delay** – Sets the delay time after the **ON: Batt** setting is reached before the AUX output is activated.
- **OFF: Batt** – Sets the low-voltage level at which the **AC Divert** function deactivates the AUX output.
- **Delay** – Sets the delay time after the **OFF: Batt** setting is reached before the AUX output is deactivated.

Figure 117 Divert AC

Inverter Stacking



IMPORTANT:

All inverters connected to ports on the HUB must be assigned valid designations for stacking and Power Save Levels. If this is not done, the system may give any number of Error messages or other symptoms.

The Inverter Stacking menu contains settings to coordinate, or “stack”, multiple inverters in a combined system. It also has settings for Power Save Levels, which allow unused inverters to go into Silent mode to save power.

Stacking assigns an inverter to a particular phase or “leg”. Any inverter connected to an OutBack HUB must be designated as master or slave of some type.

The available stacking configurations and menu options will vary with inverter model. Stacking configurations, options, and other details are discussed in both the *Installation Manual* and the *Operator’s Manual* for the inverter.



IMPORTANT:

Inverters with higher-level settings will go into Silent mode sooner. The master must stay on and should have the lowest setting. The default is zero (0). Normally it should be left at zero (0).



IMPORTANT:

- Stack Modes are inverter-dependent. The modes listed in this section show all possible Stack Modes, some of which may not be available with all OutBack inverters.
- The inverter’s *Installation Manual* describes the available stacking configurations for each inverter and the modes required for each.
- Do not select Stack Modes other than those identified for the specific inverter model being used.



CAUTION: Equipment Damage

Ensure the inverter outputs are turned off, or disconnected, before programming. Failure to do so could result in damage to the equipment.

Inverter Stacking

Port 1

Stack Mode **1-2phase Master**
 Master Power Save Level 0
 Slave Power Save Level 1

Set Points:

- **Stack Mode** – Assigns the inverter to a specific priority and phase (leg). This assignment must be made for every inverter that is connected to a HUB port. In a multiple-inverter system, one inverter must be assigned as master. The others are assigned to other phases or as slaves.
 - ~ **Master** or **1-2phase Master** – The primary inverter for single-unit systems, single-phase systems, or split-phase systems. In models where this selection reads **Master**, it is also used for three-phase systems.
 - ~ **Slave** – A secondary inverter in a stacked system. This specific selection is used for parallel-stacked Radian inverters. It is the only stacking option for these models.
 - ~ **Classic Slave** – A secondary inverter, partly independent of the master. This slave is L2 (phase 2), with output 180° out of phase from the master.
 - ~ **OB Slave L1** – A secondary inverter for single-phase (parallel) or split-phase multiple-inverter systems. An L1 slave is in the same phase as the master.
 - ~ **OB Slave L2** – A secondary inverter for split-phase multiple-inverter systems. This slave is L2 (phase 2), which is 180° out of phase from the master.
 - ~ **3p Master** or **3phase Master** – The primary inverter for three-phase systems that include the selection **1-2ph Master** as shown above. The **3p Master** is Phase A.
 - ~ **3phase Classic B (C)**, or **3p OB Slave A (B/C)** – A secondary inverter for three-phase systems. Its output is 120° out of phase with other phases. Used in newer models where the phases are manually assigned.
 - ~ **3phase Slave** – A secondary inverter for three-phase systems. Its output is 120° out of phase with other phases. Used in older models where the phases are assigned based on the inverter's position in the HUB.
- **Master Power Save Level** – Sets the inverter priority so that unused slaves go into Silent mode. This setting is only used with the master (the unit on Port 1). It is visible on other ports, but should not be used on ports other than Port 1.
- **Slave Power Save Level** – Sets the inverter priority so that unused slaves go into Silent mode. This setting is only used with slave units (units on ports other than Port 1). It is visible for the master, but should not be used on Port 1.

Figure 118 Inverter Stacking

Grid-Tie Sell

The following descriptions apply to grid-interactive inverter models only (both FX-class and Radian-class). In other models, these menus are inoperative.



IMPORTANT: FX-class grid-interactive models only

The grid-interactive function can sell power using the input connection. This function only operates if **Grid** is selected in the **AC Transfer Control** menu. It does not function if **Gen** is selected.

This menu controls the limits of the inverter’s “grid-tie” or grid-interactive function. See the inverter *Operator’s Manual* for an explanation of the grid-interactive function and how it relates to the regular charging process.

<div style="border: 1px solid black; padding: 5px; margin-bottom: 10px;"> <p style="text-align: center;">Grid-Tie Sell Port 1</p> <p>Grid-Tie Enable Y Sell Voltage 26.0 VDC Grid-Tie Window IEEE</p> </div>	<p>Set Points:</p> <ul style="list-style-type: none"> ➤ Grid-Tie Enable – Enables or disables the inverter’s grid-interactive function. If Y is selected, the function is turned on. If N is selected, the function is turned off. <p>NOTE: If the MATE3’s Enable Auto Grid-Tie Control menu item (see page 128) is set to Y (yes), Grid-Tie Enable may be turned on according to MATE3 and FLEXnet DC automatic criteria, even if it is manually turned off here. Grid-Tie Enable will switch to Y.</p> ➤ Sell Voltage – Sets the operating point for the grid-interactive function. When a renewable source raises the batteries above this point, the inverter exports power in order to bring the voltage back down. (The inverter cannot import AC power to raise the batteries to this level.) This means the Sell feature only functions when excess DC power is available. (However, if the charger is operating, it can also sell power using other charger set points. See the inverter <i>Operator’s Manual</i> for more details.) ➤ Grid-Tie Window – Sets the requirements that the utility grid must meet for the grid-interactive function to work. If the voltage and frequency are within the ranges specified in each selection, the inverter can sell power. Otherwise, the selling function will not operate. The unit will display a message in the Sell Status menu (see page 39). Two selections are available, IEEE and user. Specific settings for each set point are listed in the inverter <i>Operator’s Manual</i>. <ul style="list-style-type: none"> ~ The IEEE selection has narrower settings than the user setting. ~ IEEE is required by most utilities in the United States. (For American models, its voltage and frequency criteria are preset to the requirements of UL1741 and IEEE 1547.)
---	--

Figure 119 Grid-Tie Sell

Calibrate

The **Calibrate** menu allows adjustment of the inverter's internal voltmeters. If a particular inverter's readings do not match those of another inverter or a hand-held meter, the calibration feature may be used to improve consistency.

Calibrate		Port 1
Input Voltage	115 VAC	x
Output Voltage	115 VAC	x
Battery Voltage	28.5 VDC	0.0

↑
Calibration Offset
(x = +1 to -3)

Set Points:

- **Input Voltage** – Calibrates the AC voltage measurement made at the inverter's AC input (from an incoming AC source).
- **Output Voltage** – Calibrates the AC voltage measurement made at the inverter's AC output (from the inverter's own power, or from an incoming AC source).
- **Battery Voltage** – Calibrates the DC voltage measurement made at the inverter's DC terminals.

Figure 120 Calibrate Screen

Figure 120 shows the current readings being taken by the inverter in Vac and Vdc. However, the field to the right of each value is the calibration setting. The settable range will vary with inverter model. See the inverter *Operator's Manual* for specific ranges.



IMPORTANT:

Calibration does not change the actual output of the inverter, only the reading of that output.

Also, measurements in places other than the inverter's terminals may differ regardless of calibration. For example, it is possible to get a different reading at the inverter's DC terminals than on the batteries. Connection problems, corrosion, and the effects of induction and resistance may all result in voltage differences. If this occurs, note that this is an issue with the system, not the inverter. Calibration cannot correct for it.

Reset the Inverter to Factory Defaults

This menu allows the user to erase all settings from the selected inverter and start over with the values programmed at the factory. These values are listed in the inverter *Operator's Manual*.

To access the Reset Inverter to Factory Defaults menu:

1. Access the **Main Menu** as shown in Figure 71.
2. Select the **Settings Menu**. (This option may be highlighted by default.)
3. Select **Inverter** in the device **Settings Menu**.
4. Select the **Reset to Factory Defaults** menu.
5. Use the soft keys to select **No** or **Yes**.
 - If **<No>** is selected, the screen returns to the **Inverter** menu. No changes will be made to any settings.
 - If **<Yes>** is selected, the inverter's settings will immediately change to the original factory values. The screen will display the message **Inverter Restored to Factory Defaults**. A **<Continue>** soft key will appear. Pressing this key will return the screen to the **Inverter** menu.
6. After resetting the inverter to factory default parameters:
 - press the **<Continue>** soft key or the **Up** navigation key to return to the **Inverter** menu, or
 - press the **Top** navigation key to return to the **Settings Menu**.

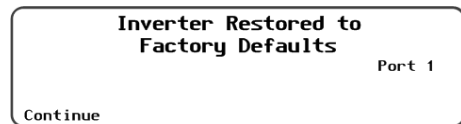
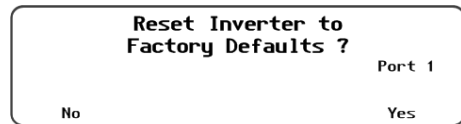
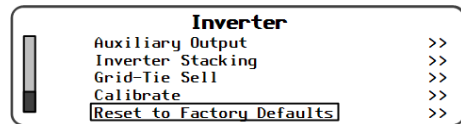
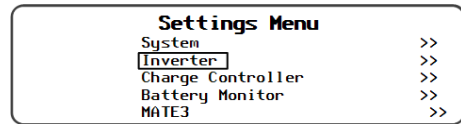
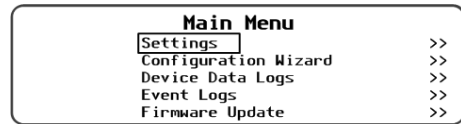

Press **<Continue>** to return to the **Inverter** menu.

Figure 121 Restoring the Inverter to Factory Default Settings

Charge Controller Settings

Charge Controller menu options include the following:

- **Charger**-----> See below.
- **MPPT**-----> See page 105.
- **Temperature Compensation**-----> See page 106.
- **Battery Equalize**-----> See page 106.
- **Grid-Tie Mode**-----> See page 107.
- **Auxiliary Output**-----> See page 107.
- **Restart Mode**-----> See page 110.
- **Calibrate**-----> See page 110.
- **Reset Charge Controller to Factory Defaults**-----> See page 111.

Charger



IMPORTANT:

Battery charger settings need to be correct for a given battery type. Always follow battery manufacturer recommendations. Making incorrect settings, or leaving them at factory default settings, may cause the batteries to be undercharged or overcharged.

The charge controller uses a “three-stage” battery charging cycle which utilizes multiple settings. This menu controls the voltages and timers for the battery charger. See the charge controller *Owner’s Manual* for an explanation of the three-stage cycle and a description of the individual stages.

Charger			Port 6
Absorb Voltage	29.4 VDC	Time	1.0
Float Voltage	26.8 VDC		
ReBulk Voltage	24.0 VDC		
Current Limit	80 A	Absorb End Amps	0

Set Points:

- **Absorb Voltage** – Adjusts the target voltage of Bulk and Absorption stages.
- **(Absorb) Time** – Adjusts the duration of the Absorption stage.
- **Float Voltage** – Adjusts the target voltage of the Float stage.
- **Rebulk Voltage** – Adjusts the point of low battery voltage that triggers a new Bulk stage after 90 seconds.
- **Current Limit** – Adjusts the maximum amperage of the battery charger.
- **Absorb End Amps** – Adjusts the level of “trickle” charge that will override the Absorb Time setting and switch the controller to the Float stage.

Figure 122 Charger

MPPT

The charge controller uses a maximum power point tracking (MPPT) algorithm which manipulates the output of the PV array to harvest maximum wattage. Although this function is automatic, this menu allows the user to adjust many of its parameters for special applications. See the charge controller *Owner's Manual* for more details on these parameters and their applications.

M P P T				Port 6
MPPT Mode	AUTO	U-Pick	VOC	77 %
Wakeup VOC Change	6.0 VDC	Time		5 Mins
Snooze Mode Amps	0.6			
MPP Range Minimum	Half	Maximum		85%

Set Points:

- **MPPT Mode** – Selects between **Auto** (which allows automatic MPPT) and **U-Pick** (which limits the maximum power point tracking to a specified voltage).
- **U-Pick VOC** – Adjusts the maximum power point tracking limit, as a percentage of the array's open-circuit voltage (V_{oc}).
- **Wakeup VOC Change VDC** – The controller monitors the array V_{oc} for a voltage increase sufficient for the controller to leave Snooze mode and begin maximum power point tracking. This setting adjusts the amount of voltage increase for wakeup. (The charge controller *Owner's Manual* refers to this under the title "Wakeup Mode.")
- **Wakeup VOC Change Time** – The controller monitors the array V_{oc} and amperage to see if they are maintained long enough for the controller to leave Snooze mode and begin MPP tracking. (The voltage level must be at least 0.3 Vdc above battery voltage; the current level is controlled by the **Snooze Mode Amps** set point.) This setting adjusts the minimum time for wakeup. (The charge controller *Owner's Manual* refers to this under the title "Wakeup Mode.")
- **Snooze Mode Amps** – Adjusts the required current level detected by the controller during the wakeup time (see previous item).
- **MPP Range Minimum** – Adjusts the lower limit of the controller's tracking algorithm. This can narrow the focus of the initial MPPT process. The options are half the array's V_{oc} , or the full V_{oc} . (The *Owner's Manual* refers to this under the title "Mpp Range Limit %.")
- **MPP Range Maximum** – Adjusts the upper limit of the controller's maximum power point tracking algorithm. The options are 80%, 85%, 90%, and 99% of the array's V_{oc} . (The *Owner's Manual* refers to this under the title "Mpp Range Limit %.")

Figure 123 MPPT

Temperature Compensation

When equipped with the Remote Temperature Sensor (RTS), the charge controller compensates for temperature changes by raising or lowering its charging voltages. However, in some cases the sensitivity of other DC devices may require this temperature compensation to be limited. This menu allows the user to manually adjust the upper and lower limits of temperature compensation. See the charge controller *Owner's Manual* for an explanation of temperature compensation and more information on manual limits.

<p>Temperature Compensation Port 6</p> <p>Mode Wide Limited: Lower Battery Voltage 26.9 VDC Limited: Upper Battery Voltage 28.3 VDC</p>	<p>Set Points:</p> <ul style="list-style-type: none">➤ Mode – Selects between Wide, which allows full compensation, and Limited, which allows the manual limits controlled by the next two set points. (The charge controller <i>Owner's Manual</i> features this as an option under “RTS Compensation.”)➤ Limited: Lower Battery Voltage – Adjusts the lowest allowed compensated voltage. (The <i>Owner's Manual</i> features this as an option under “RTS Compensation.”)➤ Limited: Upper Battery Voltage – Adjusts the highest allowed compensated voltage. (The <i>Owner's Manual</i> features this as an option under “RTS Compensation.”)
--	--

Figure 124 Temperature Compensation

Battery Equalize



CAUTION: Battery Damage

- Do not equalize any sealed battery types (VRLA, AGM, Gel, or other) unless approved by the manufacturer. Some batteries may suffer severe damage from equalization.
- Contact the battery manufacturer for recommendations on equalization voltage, duration, schedule, and/or advisability. Always follow manufacturer recommendations for equalization.

This menu controls the settings for the equalization process, which is used for battery maintenance. See the charge controller *Owner's Manual* for an explanation of equalization and how it relates to the regular charging process.

<p>Battery Equalize Port 6</p> <p>Equalization Voltage 31.0 VDC Hours 1 Automatic Battery Equalization 0 Days (Auto Equalization off if days equal 0)</p>	<p>Set Points:</p> <ul style="list-style-type: none">➤ Equalization Voltage – Adjusts the voltage of the Equalization cycle.➤ Hours – Adjusts the duration of the Equalization timer, once the voltage has been reached.➤ Automatic Battery Equalization – Sets the charge controller on an automatic schedule which will begin a new equalization cycle after a certain number of days. If this number is set to 0, the automatic schedule is disabled.
---	--

Figure 125 Battery Equalize

Grid-Tie Mode



IMPORTANT:

Grid-Tie Mode requires a grid-interactive inverter model (also known as grid-tied or grid-tie enabled). Not all inverters are grid-interactive. If the MATE3 is connected to an inverter that is not grid-interactive, Grid-Tie Mode will not function if selected.

This menu allows the charge controller to work more effectively with any grid-interactive inverters present on the HUB. When enabled, this setting automatically raises the charge controller’s Float voltage to equal its Absorption voltage. Since the inverter sells power to maintain its own Float, Absorption, or Sell settings (all of which should be lower than those of the controller), this mode makes it easier for the inverter to sell power.

NOTE: The charge controller’s Float voltage returns to normal any time the inverter enters *PassThru* or *Silent* modes. (See page 40 for inverter modes.)

Grid-Tie Mode

Enable Grid-Tie Mode N Port 6

Set Points:

- Two options are available in this menu; **N** and **Y**.
- ~ **N**(No) disables Grid-Tie Mode
- ~ **Y**(Yes) enables Grid-Tie Mode

Figure 126 Grid-Tie Mode

Auxiliary Output on the Charge Controller

This menu controls the output and functionality of the Auxiliary (AUX) output. The charge controller’s AUX terminals provide a 12 Vdc output that can deliver up to 0.2 Adc to control external loads. Typical loads include signaling a generator to start, sending a fault alarm signal, or running a small fan to cool the inverter. See the charge controller *Owner’s Manual* for more information on hooking up the AUX terminals.

Auxiliary Output

Status Manual Off Port 6

Aux Mode Float

Off Auto On

Set Points:

- **Status** – The **Auxiliary Output** status is controlled by the **<Off>**, **<Auto>**, and **<On>** soft keys.
 - ~ **<On>** activates the **Auxiliary Output** immediately. It will display the message **Manual On** and remain continuously active until **<Off>** is selected.
 - ~ **<Auto>** activates the **Auxiliary Output** by automatic criteria, according to the option selected in **Aux Mode**. When activated, it displays the message **Auto On**; otherwise it displays **Auto Off**.
 - ~ **<Off>** deactivates the **Auxiliary Output** and prevents any of the charge controller’s automatic AUX options from working. When **<Off>** is selected, it will display **Manual Off**. Note that even if the AUX output is set to **Off**, it may still be activated by an external option not based in the charge controller, such as AGS. (See page 115.)
- **Aux Mode** – Selects one of nine functions. (These functions are described in greater detail on page 108 through page 110.)

Aux Modes:

- **Vent Fan**
- **PV Trigger**
- **Error Output**
- **Night Light**
- **Float**
- **Diversion:Relay**
- **Diversion:Solid St**
- **Low Battery Disconnect**
- **Remote**

Figure 127 Auxiliary Output

Aux Modes for the Charge Controller

Aux Modes include nine functions with automatic criteria. The functions appear in the following order when the wheel is drawn clockwise. The **Vent Fan** option appears first if the charge controller is set at factory default values; otherwise, it will display the last option selected. (The options are described in greater detail in the charge controller *Owner's Manual*.)

- **Vent Fan** activates the AUX output in response to high DC (battery) voltage. It can operate a small fan to ventilate the battery compartment to eliminate gases that result from battery charging. The output deactivates when the voltage drops below the set point.
 - This function has settable DC voltage parameters.

Auxiliary Output		Port 6
Status Manual Off		
Aux Mode Vent Fan		
Enable Voltage > 28.8		
Off	Auto	On

Set Points:

- **Enable Voltage** – Adjusts the high-voltage setting at which the AUX output is activated.

Figure 128 Vent Fan

- **PV Trigger** activates the AUX output any time the PV voltage exceeds the specified number. Among other things, this can be used to operate an alarm or an emergency relay if the Voc runs dangerously high.
 - This function has settable DC voltage and time parameters.

Auxiliary Output		Port 6
Status Manual Off		
Aux Mode PV Trigger		Active High
Enable Voltage > 140 VDC		
Hold Time 0.0 Seconds		
Off	Auto	On

Set Points for PV Trigger:

- **Enable Voltage** – Adjusts the high-voltage setting at which the AUX output is activated (assuming **Active High**).
- **Hold Time** – Adjusts the time delay after reaching the **Enable Voltage** setting before the AUX output is activated.
- **Active: High or Low.** **Active High** activates the AUX output when conditions are met; **Active Low** deactivates the output when the same conditions are met but activates it the rest of the time.

Figure 129 PV Trigger

- **Error Output** responds to two emergency conditions: low battery or failure to charge. Low battery is defined by a set point. Failure to charge is defined by the PV voltage failing to exceed 3 Vdc above the battery voltage for 26 consecutive hours. This option usually indicates an array problem and is meant to operate an alarm.

NOTE: This option is “Active Low” only. The AUX output is activated as long as these conditions are not met. If they are met, the output is deactivated.

- This function has settable DC voltage parameters.

Auxiliary Output		Port 6
Status Manual Off		
Aux Mode Error Output		
Low Battery Voltage < 23.0 VDC		
Off	Auto	On

Set Points for Error Output:

- **Low Battery Voltage** – Adjusts the low-voltage setting at which the AUX output is deactivated.

Figure 130 Error Output

- **Night Light** uses the PV voltage as a light sensor. When it drops below a settable voltage (due to low light), the AUX output activates for the purpose of operating a light. It remains active for a settable amount of time.
 - ➔ This function has settable DC voltage and time parameters.

Auxiliary Output			Port 6
Status Manual	Off		Active Low
Aux Mode	Night Light		ON Time 4 Hours
Threshold	20 VDC		
Hysteresis Time	ON	Off	Auto On

Set Points :

- **Active High or Low.**
 - ~ **Active High** activates the AUX output when conditions are met;
 - ~ **Active Low** deactivates the output when the same conditions are met, but activates it the rest of the time.
- **Threshold** – Adjusts the low-voltage setting at which the AUX output is activated (following the **Hysteresis Time**).
- **ON Time** – Adjusts the amount of time that the AUX output will remain activated.

Figure 131 Night Light

- **Float** activates the AUX output when the charge controller enters the Float stage of charging. This may be used to operate functions which require the batteries to be fully charged. This mode is shown in Figure 107. **Float** does not have adjustable settings.
- **Diversion: Relay** activates the AUX output upon reaching the target voltage for charging. The output is used to operate a standard relay for controlling a diversion load.
- **Diversion: Solid St** activates the AUX output upon reaching the target voltage for charging. The output is pulse-width-modulated (PWM) for exact control. It is used to operate a solid-state device for controlling a diversion load.
 - ➔ This function has settable DC voltage and time parameters.

Auxiliary Output			Port 6
Status Manual	Off		Active Low
Aux Mode	Diversion: Relay		ON Time 4 Hours
Relative Voltage	0.0	Hysteresis	0.2 VDC
Hold	0.1 Seconds	Delay	0 Seconds
	Off	Auto	On

Auxiliary Output			Port 6
Status Manual	Off		Active Low
Aux Mode	Diversion: Solid St		ON Time 4 Hours
Relative Voltage	0.0	Hysteresis	0.2 VDC
Hold	0.1 Seconds	Delay	0 Seconds
	Off	Auto	On

Set Points:

NOTE: All items function identically for both **Diversion: Relay** and **Diversion: Solid St**, except for **Active: High or Low**. All items are written assuming **Active High** logic.

- **Active: High or Low.**
 - ~ **Active High** activates the AUX output when conditions are met;
 - ~ **Active Low** deactivates the output when the same conditions are met, but activates it the rest of the time. (Not available in **Diversion: Solid St**.)
- **Relative Voltage:** Activates the AUX output within a certain range of the target voltage (Float, Absorb, etc.). This setting controls the range.
- **Hysteresis:** Once the AUX output is activated, this setting adjusts the allowable voltage range for it to continue being active.
- **Hold:** Sets the amount of time allowed after exiting the **Hysteresis** range before the AUX output is deactivated. If the voltage re-enters the **Hysteresis** range before the timer expires, the timer resets.
- **Delay:** Adjusts the delay time before the AUX output is activated upon reaching the **Relative Voltage**.

Figure 132 Diversion:Relay and Diversion: Solid St

Programming

- **Low Batt Disconnect** activates the AUX output upon reaching a settable low-battery voltage. This option is intended as a low-battery disconnect function for DC loads.
 - ➔ This function has settable DC voltage and time parameters.

```
Auxiliary Output
Status Manual Off      Port 6
Aux Mode Low Batt Disconnect
Disconnect < 27.2   Re-Connect > 28.8 VDC
Disconnect Delay    1 Seconds
                   Off      Auto      On
```

Set Points for Low Batt Disconnect:

- **Disconnect** – Adjusts the low-voltage setting at which the AUX output is activated, following the **Disconnect Delay**.
- **Re-Connect** – Adjusts the setting at which the AUX output is deactivated again after reaching **Disconnect**.
- **Disconnect Delay** – Adjusts the time delay after reaching the **Disconnect** setting, before the AUX output is activated.

Figure 133 Low Batt Disconnect

- **Remote** allows the AUX output to be activated in response to manual or automatic commands based in the MATE3 (such as AGS). **Remote** has no adjustable settings.

Restart Mode

This setting allows the user to choose between continuous MPP tracking, or occasional restarts of the sweeping process. A restart means the controller abandons the existing maximum power point and “re-sweeps”, or begins gathering new power point data.

```
Restart Mode
Restart Mode 0      Port 6
```

Set Points:

- **0** – Initial sweep and then continuous MPP tracking.
- **1** – Automatic re-sweep every 90 minutes if controller is in an MPPT mode (MPPT Float, MPPT Bulk etc).
- **2** – Automatic re-sweep every 90 minutes if controller is in any charging mode.

Figure 134 Restart Mode

Calibrate

The Calibrate menu allows adjustment of the charge controller’s battery voltmeter. If a particular controller’s readings do not match those of another device, or a hand-held meter, the calibration feature may improve consistency.

```
Calibrate
Battery Voltage      VDC 0.0      Port 6
                    ↑
                    Calibration Offset
                    (x = +1 to -3)
```

Set Points:

- **Battery Voltage** – Calibrates the DC voltage measurement made at the controller’s battery terminals.

Figure 135 Calibrate

NOTE: Calibration does not change the actual voltage of the charge controller, only the reading of that voltage.

Also, measurements in places other than the charge controller’s terminals may differ regardless of calibration. For example, it is possible to get a different reading at the charge controller’s DC terminals than on the batteries. Connection problems, corrosion, and the effects of induction and resistance may all result in voltage differences. If this occurs, note that this is an issue with the system, not the charge controller. Calibration cannot correct for it.

Reset Charge Controller to Factory Defaults

This menu allows the user to erase all settings from the selected charge controller and start over with the values programmed at the factory. These values are listed in the charge controller *Owner's Manual*.

To access the Reset to Factory Defaults menu:

1. Access the **Main Menu** as shown in Figure 71.
2. Select the **Settings Menu**. (This option may be highlighted by default.)
3. Select **Charge Controller** in the device **Settings Menu**.
4. Select the **Reset to Factory Defaults** menu.
5. Use the soft keys to select **No** or **Yes**.
 - If **<No>** is selected, the screen returns to the **Inverter** menu. No changes will be made to any settings.
 - If **<Yes>** is selected, the inverter's settings will immediately change to the original factory values. The screen will display the message **Charge Controller Restored to Factory Defaults**. A **<Continue>** soft key will appear. Pressing this soft key will return the screen to the **Charge Controller** menu.
6. After resetting the inverter to factory default parameters:
 - press the **<Continue>** soft key or the **Up** navigation key to return to the **Charge Controller** menu, or
 - press the **Top** navigation key to return to the **Settings Menu**.

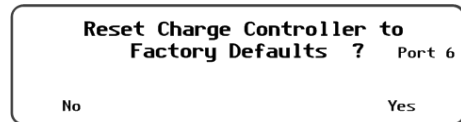
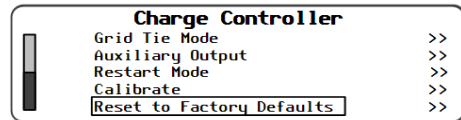
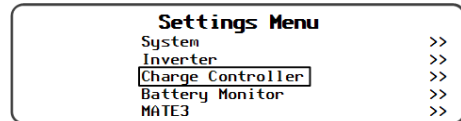
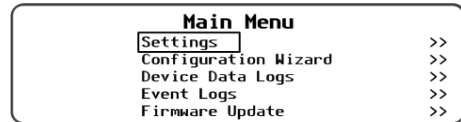

Press **<Continue>** to return to the **Charge Controller** menu.

Figure 136 Restoring the Charge Controller to Factory Default Settings

Battery Monitor Settings

Battery Monitor menu options include the following:

- **Battery Setup**-----> See below.
- **Shunt Enable**-----> See below.
- **FLEXnet Relay Mode**-----> See page 113.
- **FLEXnet Relay Set Points**-----> See page 113.
- **Reset to Factory Defaults**-----> See page 114.

Battery Setup

This menu allows the user to set the parameters for the battery bank in that particular system. These figures are used by the FLEXnet DC battery monitor to track the status of the battery bank. (Many of these figures must be given by the battery manufacturer.) For more information on the battery monitor, see the *Owner's Manual* for the FLEXnet DC.

Battery Setup

Battery AH **400**
Charged Voltage 29.2 Time 1 Minutes
Charged Return Amps 8.0
Charge Factor 94%

Set Points:

The following set points are the “fully charged” parameters for the batteries. When these parameters are met, the SOC percentage indicator meter on the Home screen will read 100% and will flash light and dark.

- **Battery Amp-hours** – Identifies the total size of the battery bank in amp-hours.
- **Charged Voltage** – Sets the minimum voltage the three-stage charger must reach during the Bulk or Absorption stages for the battery monitor to consider the batteries fully charged.
- **Charged Return Amps** – Sets the limit to which the charging current must “trickle down” or decrease before the batteries are considered charged.
- **Time** – Sets the duration the **Charged Voltage** and **Charged Return Amps** must be maintained before the charging cycle is considered finished.
- **Charge Factor** – Adjusts the anticipated charging efficiency of the batteries. Because the batteries cannot be 100% efficient, the battery monitor discounts a certain percentage of the energy used to charge them. This provides a more realistic estimate of the amount of charge that has been restored.

Figure 137 Battery Setup

Shunt Enable

This menu allows the user to turn on or off any of three shunts (current sensors) used by the battery monitor. For more information on the use of each shunt, see the *Owner's Manual* for the FLEXnet DC.

Shunt Enable

Shunt A Enable **Y**
Shunt B Enable **N**
Shunt C Enable **N**

The settings for each shunt are **Y**(yes) and **N**(no).

Y instructs the battery monitor to monitor a particular shunt and measure the current running through it.

N instructs the battery monitor to ignore that shunt.

Figure 138 Shunt Enable

FLEXnet Relay Mode

This menu allows the user to turn on or off an internal relay. The contacts of this relay are rated for 5 amps at 30 Vdc. (This relay provides no voltage of its own.) The relay can be used as a switch to turn other devices on or off. For more information on the battery monitor, see the **FLEXnet Relay Set Points** menu, and the *Owner's Manual* for the FLEXnet DC.

FLEXnet Relay Mode

Status **Off**

Invert Logic

Off Auto On

Set Points:

- **Status** – The Relay output status is controlled by the **<Off>**, **<Auto>**, and **<On>** soft keys.
 - ~ **<On>** activates the relay immediately. Its contacts will remain continuously closed until **<Off>** is selected.
 - ~ **<Auto>** activates the relay by automatic criteria, according to the option selected in **Relay Set Points**.
 - ~ **<Off>** deactivates the relay and prevents any of the **FLEXnet Relay Set Points** options from working. Note that even if the relay output is set to **Off**, it may still be activated by an external option not based in the battery monitor, such as AGS. (See page 115.)
- **Invert Logic** – Switches the relay's function from N.O. (a normally open state) to N.C. (a normally closed state). The selections are **N** (no) and **Y** (yes). Since the default condition is N.O., the **N** selection means it remains in this state. Selecting **Y** inverts the logic to N.C. The relay will close with an audible click when this occurs.

Figure 139 FLEXnet Relay Mode

FLEXnet Relay Set Points

This menu allows the user to adjust the criteria used by the **Auto** selection in the **FLEXnet Relay Mode** menu. For more information on these criteria, see the *Owner's Manual* for the battery monitor.

FLEXnet Relay Set Points

Voltage:	High	28.0	Vdc	Low	24.0	VDC
SOC:	High	0	%	Low	%	
Delay:	High	1		Low	1	Minutes

Set Points:

- **Voltage: High** – The relay will close upon reaching a specified high voltage level following the appropriate delay.
- (Voltage) **Low** – After the relay was closed according to the **High** voltage set point, it will open again upon reaching a specified low voltage level (following the appropriate delay; see below).
- **SOC: High** – If voltage conditions are not met, the relay will close when the battery state of charge (SOC) increases to a specified percentage following the appropriate delay.
- (SOC) **Low** – After the relay was closed according to the **High** SOC set point, it will open again upon reaching a specified low SOC level following the appropriate delay.
- **Delay: High** – Sets the delay time before the relay closes due to a **High** set point. This applies to either the SOC or voltage settings.
- (Delay) **Low** – Sets the delay time before the relay opens due to a **Low** set point. This applies to either the SOC or voltage settings.

Figure 140 FLEXnet Relay Set Points

The following set points assume N.O. logic. If N.C. logic is used, all use of the words "close" or "open" are reversed.

Reset FLEXnet DC to Factory Defaults

This menu allows the user to erase undesirable settings from the battery monitor and start over with the values programmed at the factory. These values are listed in the FLEXnet DC *Owner's Manual*.

To access the Reset to Factory Defaults menu:

1. Access the **Main Menu** as shown in Figure 71.
2. Select the **Settings Menu**. (This option may be highlighted by default.)
3. Select **Battery Monitor** in the device **Settings Menu**.
4. Select the **Reset to Factory Defaults** menu.
5. Use the soft keys to select **No** or **Yes**.
 - If **<No>** is selected, the screen returns to the **Battery Monitor** menu. No changes will be made to any settings.
 - If **<Yes>** is selected, the battery monitor's settings will immediately change to the original factory values. The screen will display the message **FLEXnet DC Restored to Factory Defaults**. A **<Continue>** soft key will appear. Pressing this key will return the screen to the **Battery Monitor** menu.
6. After resetting the battery monitor to factory default parameters:
 - press the **<Continue>** soft key or the **Up** navigation key to return to the **Battery Monitor** menu, or
 - press the **Top** navigation key to return to the **Settings Menu**.

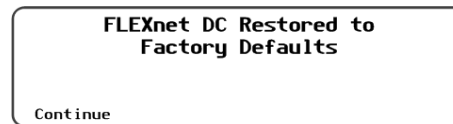
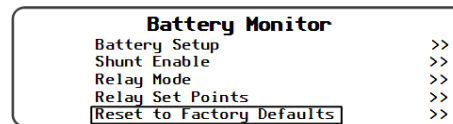
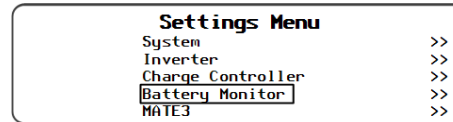
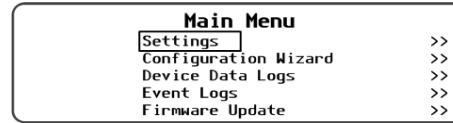

Press **<Continue>** to return to the **Battery Monitor** menu.

Figure 141 Restoring the FLEXnet DC Monitor to Factory Default Settings

MATE3 Settings

MATE3 Settings Menus include:

- **Advanced Generator Start** ----- > See below.
- **Setup** ----- > See page 116.
- **Voltage Start** ----- > See page 118.
- **Load Start** ----- > See page 118.
- **State-of-Charge Start** ----- > See page 118.
- **Must Run Schedule** ----- > See page 119.
- **Quiet Time Schedule** ----- > See page 119.
- **Generator Exercise Schedule** ----- > See page 120.
- **Set Total Generator Run Time** ----- > See page 121.
- **Display AGS Timers** ----- > See page 121.
- **Data Logging** ----- > See page 122.
- **High Battery Transfer** ----- > See page 122.
- **Grid Use Time** ----- > See page 125.
- **Charge Controller Float Coordination** ----- > See page 127.
- **Global Charger Output Control** ----- > See page 127.
- **FLEXnet DC Advanced Control** ----- > See page 127.
- **Reset to Factory Defaults** ----- > See page 129.

Advanced Generator Start (AGS) Mode



CAUTION: Equipment Damage

This feature can damage the generator or the batteries if either are not properly maintained. Be sure to follow all maintenance requirements for all the components in the system to prevent unnecessary and expensive damage.

The AGS Mode utilizes the auxiliary (AUX) output on the inverter or charge controller (or the FLEXnet DC relay output) and is compatible with any two-wire start generator.

AGS starts the generator any time when any of its Start conditions are met, and stops the generator when any of its Stop conditions are met. A Quiet Time schedule overrides most of the Start conditions to keep the generator from running at inappropriate hours. See Table 5 on page 152 for a list of conditions that will stop the generator.

NOTE: If AGS mode controls the AUX output of a FLEXmax charge controller, that charge controller’s **Auxiliary Output** menu must be set to **Remote** for this function to work. (See page 110.)

AGS can start a generator under the following variety of settings:

- **Voltage Start** ----- > See page 118.
- **Load Start** ----- > See page 118.
- **State of Charge % Start (FLEXnet DC)** ----- > See page 118.
- **Must Run Schedule** ----- > See page 119.
- **Quiet Time Schedule** ----- > See page 119.
- **Generator Exercise Schedule** ----- > See page 120.
- **Set Total Generator Run Time** ----- > See page 121.
- **Display AGS Timers** ----- > See page 121.

Gen Alert is another way to automatically start a generator, but it does not offer the same range of programming options as AGS. AGS is a function of the MATE3 while **Gen Alert** is a function of the inverter, which is programmed using the MATE3. Information on the **Gen Alert** function can be found on page 91 and in the inverter *Operator’s Manual*.

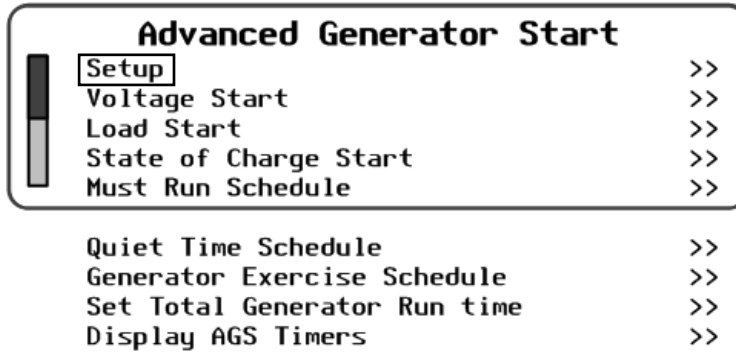
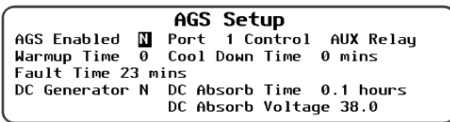
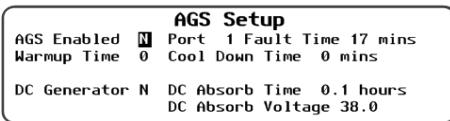

Figure 142 Advanced Generator Start (AGS) Menu

AGS Setup



NOTE:

- If there is only one inverter in the system and no OutBack HUB is used, it is necessary to set the AGS Port to zero (0).
- If a HUB is used, adjust the port number to the port that is assigned to the device that is going to control the generator.
- In an example of a common configuration:
 - ~ Ports 1-4 are for the inverters.
 - ~ Ports 5-7 are for the charge controllers.
- It will be necessary to choose which device is going to control the generator (1, 2, 3, or 4) and set that number as the AGS port in that menu.



IMPORTANT:

- Cool Down and Warmup times are disabled when a DC generator is used.
- If an AC generator is being used, the **DC Generator** menu item must be set to **N**.

Set Points:

- **AGS Enabled** either enables (**Y**) or disables (**N**) the AGS mode.
- **Port** identifies the HUB port (**1 – 10**) for the device that is going to control the generator.
- **Fault Time** is the period the generator is given to connect to the inverter system after the AUX output has been activated. If the generator fails to connect and provide AC current during this time, the MATE3 displays an **AGS Fault** message on the Gen screen. A fault is added to the event log and the Event LED will illuminate. This set point can be anywhere from **5** to **30** minutes.
- **Control** (Radian-class only) selects which terminals will be used for AGS: AUX Output or AUX Relay.
- **Warmup Time** for the generator (in minutes). Before charging begins, the **Warmup Time** allows the user to adjust the time the generator will be allowed to run with no load. This time can be from **0** to **30** minutes, but should follow the generator manufacturer’s recommendations.
- **Cool Down Time** for the generator (in minutes). After charging has stopped, the **Cool Down Time** set point allows the user to adjust the time the generator will run with no load before being shut off. This time can be from **0** to **30** minutes, but should follow the generator manufacturer’s recommendations.
- **DC Generator** identifies if a DC generator is used, instead of an AC generator.
 - ~ **DC Absorb Time** is the amount of time that the batteries must remain at the **DC Absorb Voltage**. Once this time expires, the MATE3 can shut the generator off.
 - ~ **DC Absorb Voltage** is the voltage the batteries must reach while being charged by a DC generator before the DC absorb timer starts counting.
 - ~ The **Stop SOC %** setting (see page 119) can also be used to stop a DC generator.
 - ~ These settings only become effective when **DC Generator** is set to **Y**.

Figure 143 AGS Setup Screen

AGS Functional Test

Before any further programming, confirm that the generator is working properly. Using the generator's own controls, manually turn it on and then shut it off.

Next, test the remote start functionality by using the MATE3's **Generator Status** screen.

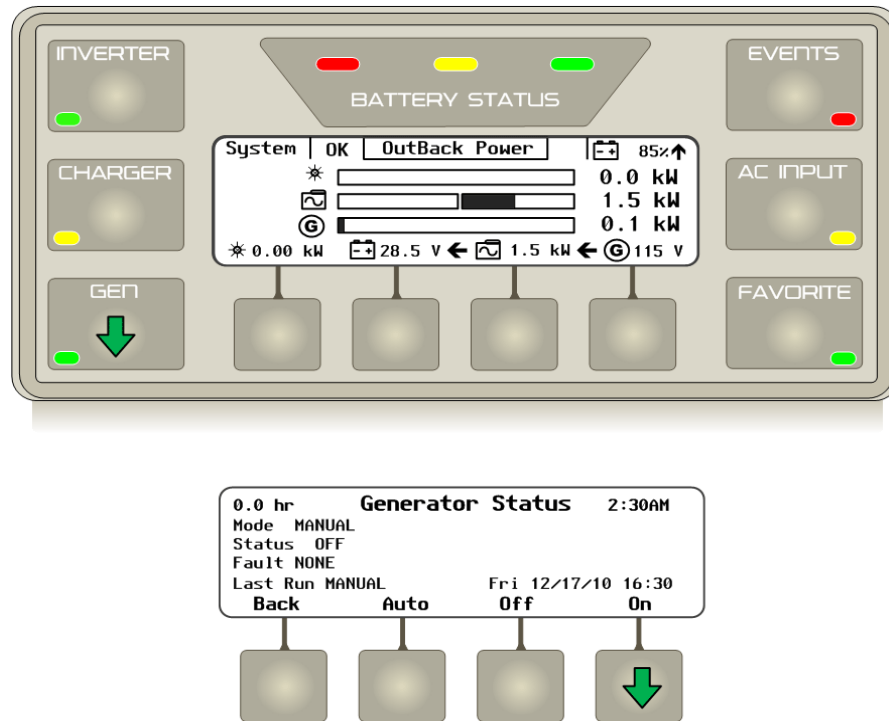

To test the AGS function through the MATE3:

1. Press the **GEN** hot key to bring up the **Generator Status** screen.
2. Press the **<ON>** soft key and wait for the generator to start running.
3. Press the **<OFF>** soft key to shut the generator off.
4. Press the **<AUTO>** soft key to put the generator in AUTO mode.
5. Press the **<BACK>** soft key to return to the Home screen.

Figure 144 AGS Functional Test

The AGS test confirms the AGS function works and the generator has been operated during the AGS programming.



IMPORTANT:

It is important not to confuse AGS with Gen Alert. These are two separate methods for requesting a generator to start. Gen Alert set points should not be used as AGS set points.

AGS Voltage Start

There are three voltage start set points in AGS mode that the user can select.

- **24 Hour Start**
- **2 Hour Start**
- **2 Minute Start**

If the voltage drops below the voltage setting in these three menu items, a timer starts counting down. When the timer reaches zero (0), a start command is sent to the generator. The **Quiet Time** settings overrides the starting set points, preventing the generator from starting automatically. The exception is **2 Minute Start**, which is considered an emergency start set point and which will start the generator regardless of **Quiet Time** settings.

After a generator is started due to a **Voltage Start** setting, it will be stopped when the inverter completes the battery charging cycle.



IMPORTANT:

If the **DC Generator** is set to **Y**, the generator will only stop after reaching the DC generator parameters shown in Figure 143 on page 116.

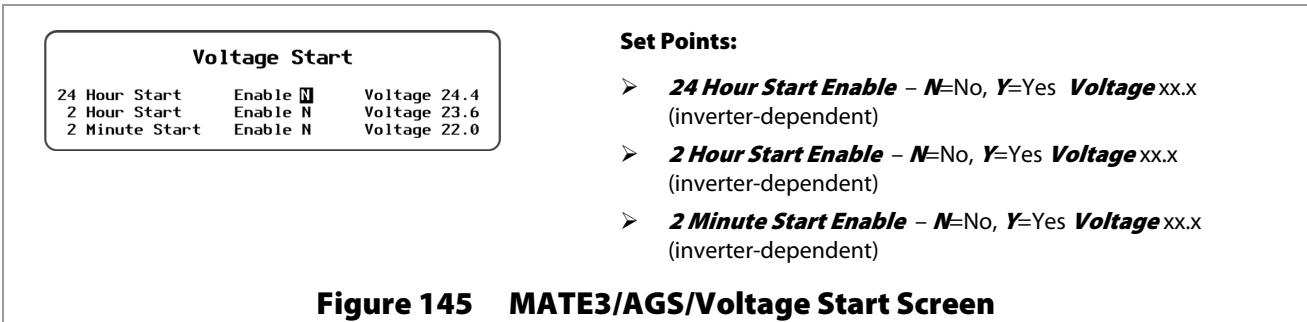

AGS Load Start

Load Start will start a generator whenever the total system AC load wattage exceeds the **Start** set point for the programmed amount of time (**Delay**). The generator will then be stopped when the AC load has dropped below a **Stop** set point for a programmed amount of time (**Delay**).

When the generator is running because of **Load Start**, the inverter system will charge the batteries. However, it is not programmed to perform a complete charge cycle. If the generator stops upon reaching its **Stop** criteria/set point, the charge might not be completed.

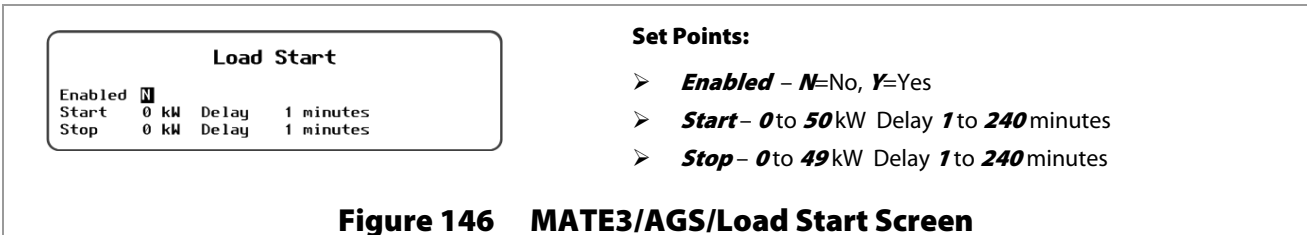

IMPORTANT:

Large, instantaneous loads can still overload the inverter prior to the generator starting and getting synchronized with the inverter. See the inverter *Operator's Manual* for instructions on resetting the inverter following an overload.

AGS State-of-Charge (SOC) Start

With a FLEXnet DC, a generator can be started or stopped based on the battery state of charge (SOC) rather than voltage. However, this feature may become less accurate if the system routinely cycles without obtaining a full charge for long periods of time.

The **Enable Full Charge** set point overrides the **Stop SOC** function by establishing a time period from 1 to 30 days. At the end of this time, the batteries will be charged to 100% regardless of the SOC value.

When **Enable Full Charge** is set to **Y**, the MATE3 will compare the **Days Since Parms Met** display (Figure 35) against the **Interval days** shown in Figure 127. If **Days Since Parms Met** is equal or higher, then the generator will run until the FLEXnet DC's charge parameters are met. More information on this function is available on page 152.

Setting **Enable Full Charge** to **N** or setting the **Interval days** to zero (0) days will disable the function.

State of Charge Start

Enable
 Start SOC 60 % Stop SOC 90 %
 Enable Full Charge N Interval 14 days

Set Points:

- **Enable** – **N**= No, **Y**= Yes
- **Start SOC** – 0 to 99%
- **Stop SOC** – 0 to 100%
- **Enable Full Charge** – **N**= No, **Y**= Yes
- **Interval Days** – 1 to 30 days; this is the time in days used by the **Enable Full Charge** (100% SOC) function and the FNDC's charging parameters.

Figure 147 MATE3/AGS/State-of-Charge Start Screen

AGS Must Run Schedule

Must Run Schedule time is a daily time period when the MATE3 commands the generator to run. This is usually set because large loads are expected to be present. **Must Run Schedule** times can be set individually for weekdays and weekends.

Setting start and stop times to the same time disables the **Must Run Schedule** function.

Must Run Schedule

Enable
 Weekday Start 0:00 Stop 0:00
 Weekend Start 0:00 Stop 0:00

Set points:

- **Enable** – **N**= No, **Y**= Yes
- **Weekday Start** – 00:00 to 23:59
- **Weekday Stop** – 00:00 to 23:59
- **Weekend Start** – 00:00 to 23:59
- **Weekend Stop** – 00:00 to 23:59

Figure 148 MATE3/AGS/Must Run Schedule Screen

AGS Quiet Time Schedule

Quiet time is a period of time when the generator should not run, due to the risk of inappropriate noise or other reasons.

Setting start and stop times to the same time disables the Quiet Time function.



IMPORTANT:

The Quiet Time settings overrides most of the starting set points (for example, Voltage, Load, Must Run, Exercise etc.), preventing the generator from starting automatically. The only exception is the **2 Minute Start** under **Voltage Start**, which is considered an “emergency” start set point and which will start the generator regardless of Quiet Time settings.

Quiet Time Schedule

Enable
 Weekday Start 0:00 Stop 0:00
 Weekend Start 0:00 Stop 0:00

Set points:

- **Enable** – *N*= No, *Y*= Yes
- **Weekday Start** – *x0:00*; this is the time during the week day that Quiet Time is initiated.
- **Weekday Stop** – *x0:00*; this is the time during the week day that Quiet Time is stopped.
- **Weekend Start** – *x0:00*; this is the time during the weekend that Quiet Time is initiated.
- **Weekend Stop** – *x0:00*; this is the time during the weekend that Quiet Time is stopped.

Figure 149 MATE3/AGS/Quiet Time Schedule Screen

AGS Generator Exercise Schedule

Exercise is a time period when the generator is scheduled to run briefly, regardless of system conditions.



IMPORTANT:

Regularly running a generator keeps engine components lubricated, expels excess moisture, charges the starting battery, and helps prevent carbon build-up. Consult the generator owner’s manual for the appropriate length and frequency of exercise periods and what load to run during the exercise period.

Generator Exercise Schedule

Enable Exercise Run on Sun
 Start Time 0:00 Run Period 15 minutes
 Exercise Interval 2 weeks
 Disable Sell During Exercise

Set points:

- **Enable** – *N*= No, *Y*= Yes
- **Exercise Run on** – *Sun (Mon – Sun)*
- **Start Time** – *0:00 to 23:59*
- **Run Period** – *1 to 240* minutes
- **Exercise Interval** – *0 to 8* weeks; this is the amount of time that will elapse between generator exercise runs.
- **Disable Sell During Exercise** – *N*= No, *Y*= Yes; this prevents a grid-interactive model from selling while the generator is being exercised. This is mostly used for DC generators.

Figure 150 MATE3/AGS/Generator Exercise Schedule Screen

Set Generator Total Run Time

The total running time for an automatic generator is displayed on the **Generator Status** screen, which is accessed with the **Gen** hot key. (See page 59.) This menu allows the timer to be set to a different figure, or to be reset to zero.

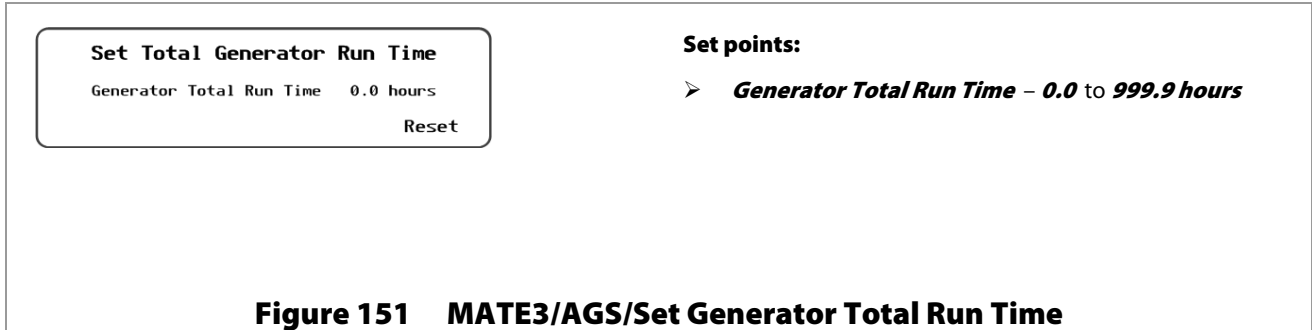

AGS Timers

The **AGS Timers** screen is a read-only screen that provides the following information. Programming of these values is done in the **Quiet Time Schedule, Voltage Start, Load Start, Must Run Schedule, or State of Charge Start** menus described on pages 116 through 119.

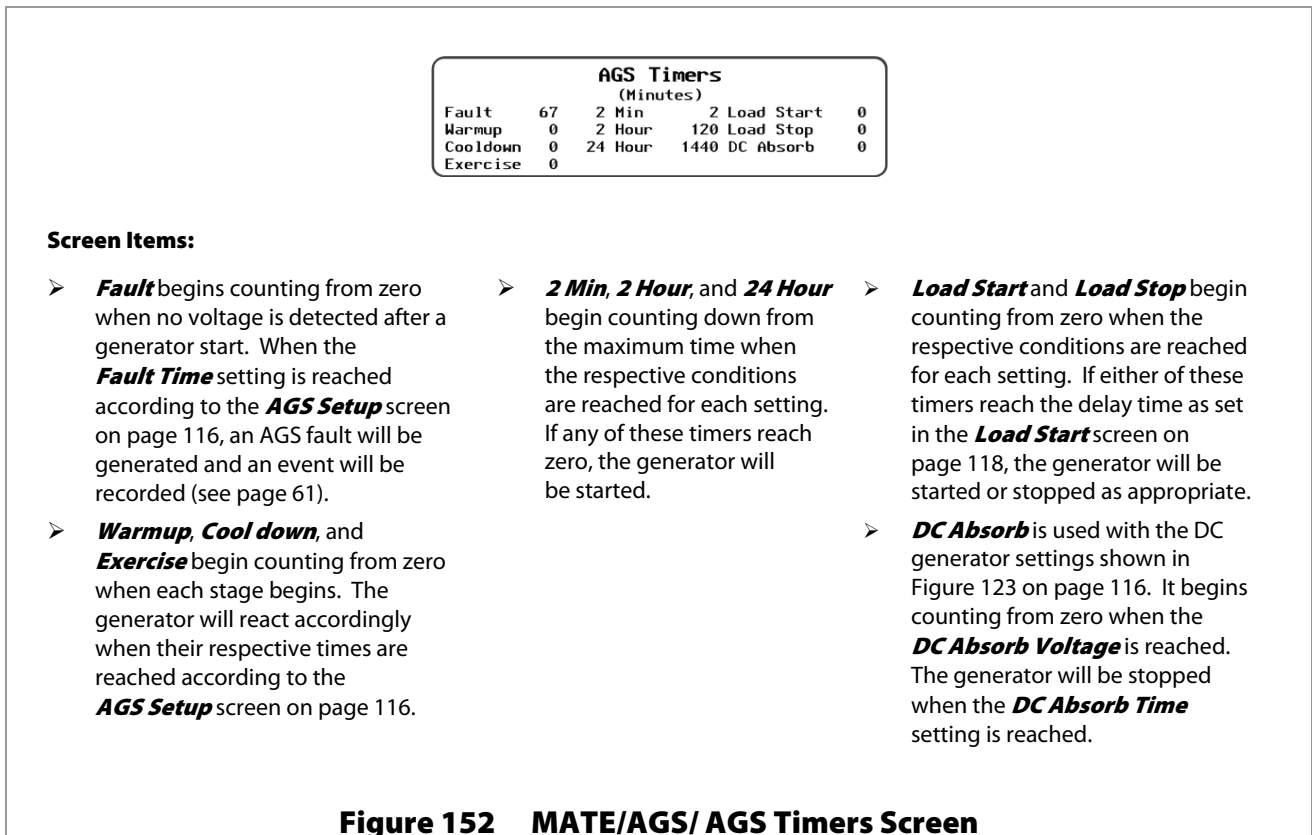

Data Logging

The **Data Logging** feature enables the MATE3 to record operational status information about the system. It will record data to the MATE3's internal flash memory for up to one year and selectively to an SD card up to the capacity of the card.

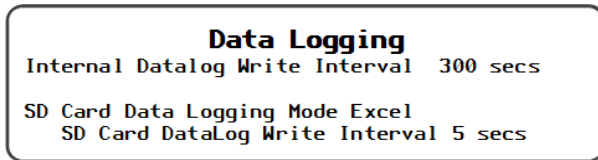
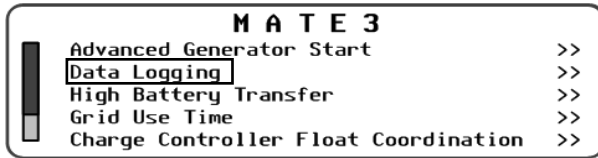

NOTE:

Excel records the full date and time for each interval recorded.

Disabled turns off data logging to the SD card. It does not turn off data logging to the internal flash memory.

Compact records only the minutes and seconds for each interval recorded.

Set Points:

- **Internal Data Log Write Interval** – 60 to 3600 seconds
- **SD Card Data Logging Mode** – *Excel, Disabled, Compact*
- **SD Card DataLog Write Interval** – 1 to 60 seconds

Figure 153 MATE3 Data Logging Screen

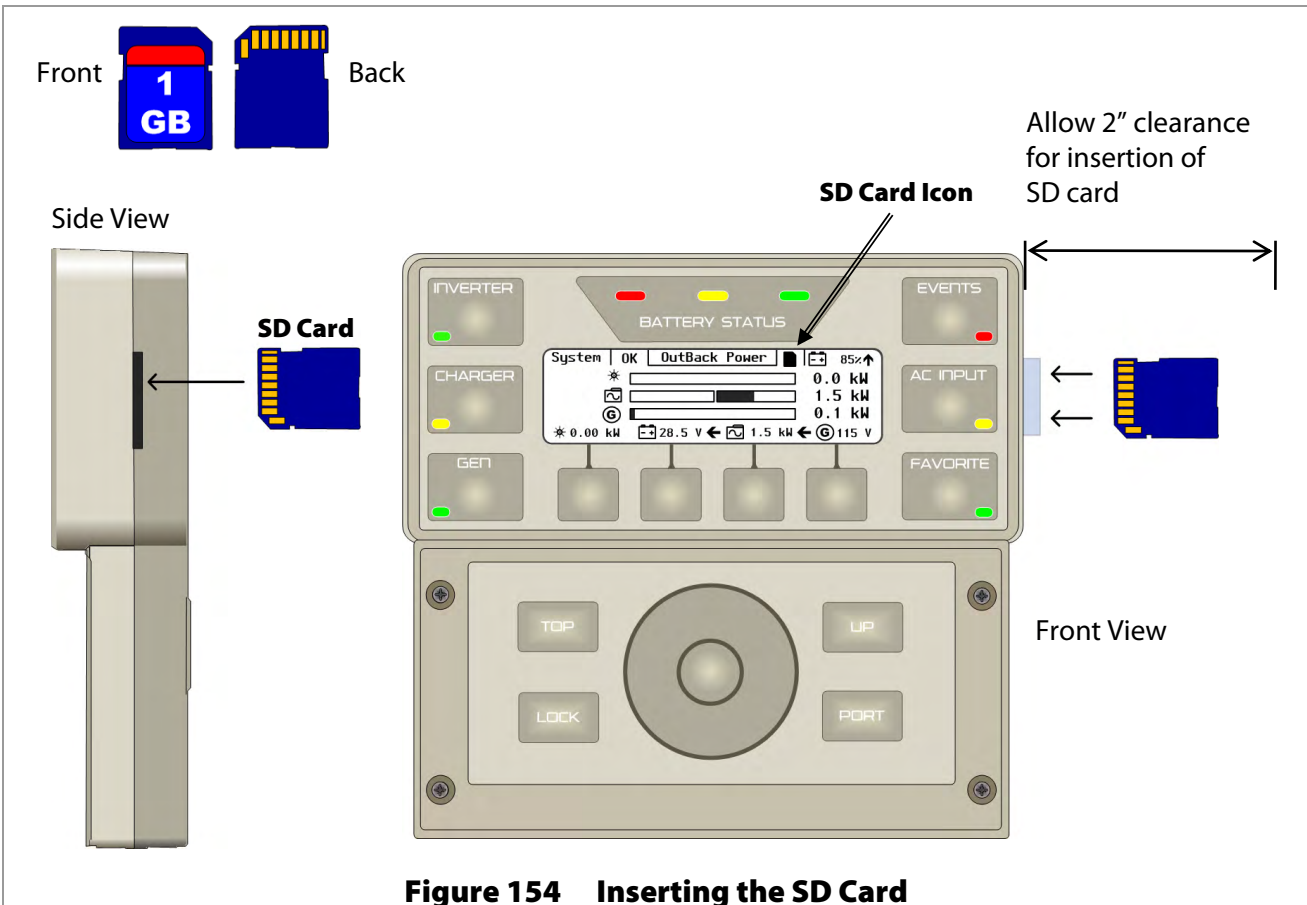

Figure 154 Inserting the SD Card

Data logging will occur at the interval set in the MATE3 Data Logging screen shown in Figure 153 on page 122. Data logging to the MATE3 internal flash memory is stored for up to one year's worth of logs. Data logs can be downloaded selectively to the SD card (as needed) or automatically to the SD card. The interval for automatic downloading to the SD Card can also be set at intervals from 1 to 60 seconds.

- For instructions on downloading data logs for the charge controller, see Figure 168 on page 139.
- For instructions on downloading data logs for the FLEXnet DC Battery Monitor, see Figure 169 on page 140.

Data Log File Format

Information generated by this function will be saved on the SD card in a generic **.csv** file format, which can be read by most spreadsheet programs. The file name on the **.csv** file will appear as follows:

Example: 11062722.csv (YMMDDHR.csv)

Where: YY = Last 2 digits of the year, MM = Month (01-12), DD = Day (01-31), HR = Hour (00-23)

An example of a system data log is as follows:

NOTE: This header line is NOT included in the download.

Date	Time	Port	Device type	Invert current	Chrg current	Buy current	Ac input voltage	Ac output voltage	Sell current	Operating mode	Error mode	Ac mode	Battery voltage	Misc	Warning mode
6/09/11	17:28:20	1	2	2	0	0	0	230	0	2	0	0	500	25	0
6/09/11	17:28:20	2	2	2	0	0	0	230	0	2	0	0	508	25	0
6/09/11	17:28:20	3	2	2	0	0	0	230	0	2	0	0	508	25	0

Figure 155 Data Log Example for the System

For Data Log file examples for the charge controller and the battery monitor, see Device Data Logs on page 139.

High Battery Transfer (HBX)

In High Battery Transfer (HBX) mode, the system is connected to an AC source such as the utility grid; however, it will use battery power as the first priority. The AC source is locked out until needed.

In this mode, the system runs on battery-supplied power for as long as the batteries can be sustained. It is expected that the batteries will also be charged from renewable sources such as PV power. When the batteries become depleted, the system reconnects to the AC source to operate the loads.

The batteries may be recharged during this time using the renewable source. When the batteries are recharged to a high enough voltage, the system transfers back to the batteries as the primary source (hence the name High Battery Transfer).

NOTE: In Radian-class inverters, the *Mini Grid* input mode can also accomplish this operation; however, it is not identical to HBX and is not compatible with it. Both functions should not be used at the same time. HBX is a function of the MATE3 while *Mini Grid* is a function of the inverter, which is programmed using the MATE3. Information on selecting *Mini Grid* can be found on page 86. Information on *Mini Grid* and other input modes can be found in the *Radian Series Inverter/Charger Operator's Manual*.

NOTE: For best operation, the inverter's charger should be turned off when HBX mode is in use. HBX mode is intended for systems that rely primarily on the renewable energy source for charging. The settings of HBX mode allow it to disconnect from the utility grid whenever it can charge effectively using the renewable source. Use of the inverter's charger may interfere with these priorities. This may keep both HBX mode and the inverter's charger from working effectively.

- See page 56 (the **CHARGER** hot key) for instructions on shutting off the charger function.

HBX Mode commands the inverter to:

- connect to an AC source if the battery voltage has fallen below the **Grid Connect** voltage for the amount of time set in the (connect) **Delay** set point,
- connect to an AC source if the battery state of charge (SOC) has fallen below the **Grid Connect SOC** for any amount of time,
- disconnect the AC source and switch to powering the loads from the battery bank if the battery voltage has risen above the **Grid Disconnect** voltage for the amount of time set in the (disconnect) **Delay** set point, and
- disconnect the AC source and switch to powering loads from the battery bank if the battery state of charge (SOC) has risen above the **Grid Disconnect SOC** for any amount of time.

The **Delay** set points are used to prevent the inverter from switching to grid power in the event of a sudden, sizable demand for power that may momentarily drop the voltage below the **Grid Connect** value.

The **SOC** set points are only usable by a system equipped with a battery monitor.

Table 3 HBX Mode Default Set Points

System Voltage	12 V	24 V	36 V	48 V
High Voltage	13	26	38	52
Low Voltage	12	24	36	48
Time	1 hour	1 hour	1 hour	1 hour

NOTE: The system must be in the **Grid Disconnect** state to allow HBX default settings to be changed.



IMPORTANT:

- HBX Mode will control the master inverter in port 1 of a HUB4 or HUB10. The master will then instruct all slaves to connect or disconnect from the AC input source.
- HBX Mode cannot be used if **Grid Use Time** is used (see below). These functions have incompatible priorities and will conflict with each other.
- HBX Mode cannot be used if the Radian inverter's **Mini Grid** mode is used (see page 86). These functions have incompatible priorities and will conflict with each other.

High Battery Transfer			
Enable	Disabled		
Grid Connect	24.0 VDC	Delay	10 Min
Grid Disconnect	26.0 VDC	Delay	10 Min
Grid Connect SOC	60 %		
Grid Disconnect SOC	90 %		

Set Points:

- **Enabled/Disabled**
- **Grid Connect** – **xx.x**VDC (inverter-dependent)
The low-voltage level that causes the system to reconnect to the utility grid.
- **(Grid Connect) Delay** – **0** to **240** minutes
The delay period after reaching **Grid Connect** before the system reconnects to the utility grid.
- **Grid Disconnect** – **xx.x**VDC (inverter-dependent)
The high-voltage level that causes the system to disconnect from the utility grid.
- **(Grid Disconnect) Delay** – **0** to **240** minutes
The delay period after reaching **Grid Disconnect** before the system disconnects from the utility grid.
- **Grid Connect SOC** – **10%** to **100%**
The low-battery state of charge that causes the system to reconnect to the utility grid immediately.
- **Grid Disconnect SOC** – **50%** to **100%**
The high-battery state of charge that causes the system to disconnect from the utility grid immediately.

Figure 156 MATE3 High Battery Transfer Screen

Grid Use Time

The Grid Use Time function allows the system to connect to (use) the utility grid and disconnect from (drop) it on a timed schedule. **Grid Use Time** mode is programmed separately for weekday and weekend connect times. Only one **Grid Use Time** may be programmed on a weekend. Three **Grid Use Time** periods may be programmed on weekdays.

Before turning the **Grid Use Time** mode on, set all weekday and weekend time periods.



IMPORTANT:

- Care must be taken when programming weekday and weekend times that encompass **USE** periods past midnight (12:00 a.m.). The user must take into account weekday **USE** periods that will end on a Saturday.
- **Grid Use Time** cannot be used if HBX mode is used (see page 122). These functions have incompatible priorities and will conflict with each other.
- **Grid Use Time** cannot be used if the Radian inverter's **Mini Grid** mode is used (see page 86). These functions have incompatible priorities and will conflict with each other.
- The time and date must be accurately programmed for the **Grid Use Time** mode to function properly.
- The MATE3 does not automatically adjust its clock for Daylight Savings Time. This may affect timing of grid usage.
- If a start time equals a stop time, no action will be taken and the time period is ignored.
- If the battery voltage falls below the inverter's Low Battery Cut-Out voltage, the inverter will automatically connect to the AC input source regardless of the time-of-day setting.

Programming

Example #1:

Weekday Start - 6:00 p.m. Weekday Stop - 6:00 a.m.

Weekend Start - 12:00 a.m. Weekend Stop - 12:00 a.m.

The weekend **USE** period has been left at its default (12:00 a.m.). Any time that a Start time equals a Stop time, no action will be taken and the time period is ignored. The above settings will have the following results:

- Monday – Friday evenings at 6 p.m., the MATE3 issues a **USE** command to the inverter allowing the AC input source to be used.
- Monday – Friday mornings at 6 a.m., a **DROP** command will be issued.
- On Friday evening at 6 p.m., a **USE** command is issued but since the Weekend Start and Stop times are equal, the weekend use time is disabled; no **DROP** command will be issued until Monday morning at 6 a.m.

Example #2:

Weekday Start - 6:00 p.m. Weekday Stop - 6:00 a.m.

Weekend Start - 4:00 p.m. Weekend Stop - 8:00 a.m.

- Monday – Thursday evenings at 6:00 p.m., the MATE3 issue a **USE** command to the inverter allowing the AC input source to be used.
- Monday – Friday at 6:00 a.m., a **DROP** command is issued. On Friday evening at 6:00 p.m., a **USE** command is issued.
- Saturday morning a **DROP** command is issued at 8:00 a.m. Saturday afternoon at 4:00 p.m., the inverter will **USE** again until Sunday morning at 8:00 a.m. Sunday evening at 4:00 p.m., a **USE** time period will start, ending on Monday morning at 6:00 a.m.

Grid Use Time			
	Enable Y	Enable N	Enable N
Weekday: Use	0:00	0:00	0:00
Weekday: Drop	0:00	0:00	0:00
Weekend: Use	0:00		
Weekend: Drop	0:00		

Set Points:

- **Enable** – **N**= No, **Y**= Yes
- **Weekday: Use** – **00:00** to **23:59**
The time during weekdays when the system is told to **Use** the utility grid. Three different **Use** times can be set.
- **Weekday: Drop** – **00:00** to **23:59**
The time during weekdays when the system is told to **Drop** the utility grid. Three different **Drop** times can be set.
- **Weekend: Use** – **00:00** to **23:59**
The time during weekends when the system is told to **Use** the utility grid.
- **Weekend: Drop** – **00:00** to **23:59**
The time during weekends when the system is told to **Drop** the utility grid.

Figure 157 MATE3 Grid Use Time Screen

Charge Controller Float Coordination

The advanced charger float control menu enables the coordination of more than one OutBack FLEXmax charge controller. (This function also works on MX60 charge controllers with firmware revision 5.11). This enables the devices to enter the float stage, or perform other activities, simultaneously rather than individually. Float Coordination means that when one charge controller finishes a bulk charge and moves into float charge, the MATE3 directs any other charge controllers into a float charge as well.

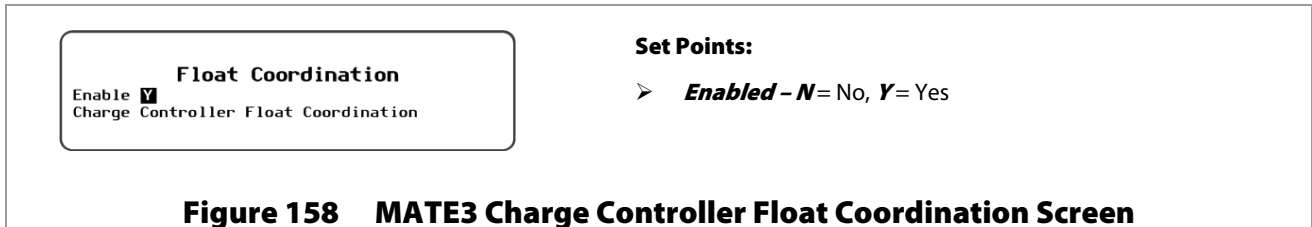

Figure 158 MATE3 Charge Controller Float Coordination Screen

Global Charger Output Control

The global charger control allows the MATE3 to limit the DC current delivered to the batteries by all FLEXmax charge controllers in the system. (This function cannot limit charge current from inverters of any kind.)

This function requires the system to have a FLEXnet DC battery monitor installed in the system. The FLEXmax charge controllers must be set to GT Mode in order to establish priority for this function. (However, the inverters in the system cannot use grid-interactive functions, if any.)

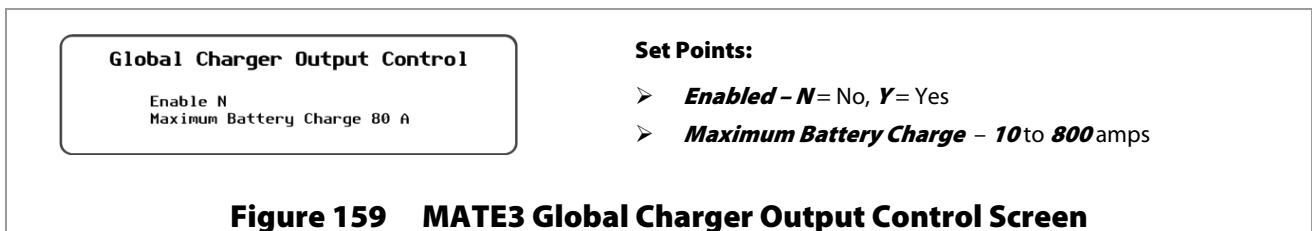

Figure 159 MATE3 Global Charger Output Control Screen

FLEXnet DC Advanced Control



IMPORTANT:

See the *FLEXnet Owner's Manual* for detailed information about the FNDC functions.

This menu allows certain advanced functions to be programmed into the FLEXnet DC (FNDC). The FLEXnet DC is required to be part of the system before any of these functions can be used.

FlexNet DC Advanced Control
Enable Charge Termination Control **Y**
Enable Auto Grid-Tie Control **N**
Battery Status:
Low SOC Warning Level 60 %
Critical SOC Warning Level 50 %

Set Points:

- **Enable Charge Termination Control** - allows the battery charging to be stopped for all inverters on the system, once the charging parameters of the FLEXnet DC have been met. (See page 112 for these parameters.) Options are **N**(no) or **Y**(yes).
- **Enable Auto Grid-Tie Control**- If grid-interactive inverters are present on the system, this control allows their grid-interactive function to be turned off at midnight each night. If grid-interactive inverters are not present, this item is inoperative. Options are **N**(no) or **Y** (yes). When **Y**is selected, "grid-tie" mode will be enabled on grid-interactive inverters anytime the battery monitor signals that charge parameters have been met.
NOTE: When grid-tie mode is enabled with this function, the **Grid-Tie Enable** menu item (see page 101) will change to **Y** (yes). The inverter will become capable of selling even if the function had been previously turned off.

The next two items are both related to the system indicators on the Home screen (see pages 33 and 151) and are titled **Battery Status** on the screen.



- **Low SOC Warning Level** If the batteries decrease to this state of charge (SOC), an event will be registered in the event log, and the Home screen will display **!** , a battery warning. Settable range is **20%** to **99%**.
- **Critical SOC Warning Level** If the batteries decrease to this state of charge (SOC), an event will be registered in the event log, and the Home screen will display **X** , a warning that the batteries have been critically discharged. Settable range is **10%** to **98%**.

Figure 160 FLEXnet DC Advanced Control

Reset MATE3 to Factory Defaults Screens

This menu allows the user to erase all settings from the MATE3 and start over with the values programmed at the factory.

To access the Reset to Factory Defaults menu:

1. Access the **Main Menu** as shown in Figure 71.
2. Select the **Settings Menu**. (This option may be highlighted by default.)
3. Select **MATE3** in the device **Settings Menu**.
4. Select the **Reset to Factory Defaults** menu.
5. Select **No** or **Yes**.
 - If **<No>** is selected, the screen returns to the **MATE3** menu. No changes will be made to any settings.
 - If **<Yes>** is selected, the MATE3's settings will immediately change to the original factory values. The screen will display the message **MATE3 Restored to Factory Defaults?** A **<Continue>** soft key will appear. Pressing this key will return the screen to the **MATE3** menu.
6. After resetting the MATE3 to factory default parameters:
 - press the **<Continue>** soft key or the **Up** navigation key to return to the **MATE3** menu, or
 - press the **Top** navigation key to return to the **Settings Menu**.

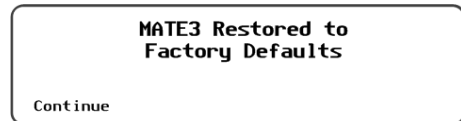
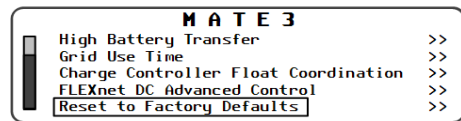
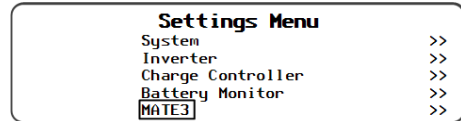
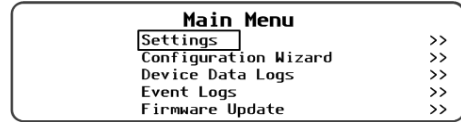

Press **<Continue>** to return to the **MATE3** menu.

Figure 161 Restoring the MATE3 to Factory Default Settings

Configuration Wizard

The Configuration Wizard is a guided program that assists in configuring system setups. An installer can create new configurations, use existing configurations, or restore configurations to their original state.

Creating New Configurations

To create a new configuration:

1. Access the **Main Menu** as shown in Figure 71.
2. Select the **Configuration Wizard** menu.
3. Select **New Configuration**.
4. Press **<Continue>** to confirm the creation of a new configuration.
5. Use the control wheel to adjust the settings in each screen where required. Record the settings on the form provided in Table 11.

Soft Keys:

<Back> moves back one screen.

<Continue> moves forward to the next screen.

```

Wizard System Type
System Type      Off Grid
System Voltage   24 VDC
Array Wattage    1000
Battery Type     FLA Capacity 500 Ah
Back             Continue
    
```

```

Wizard Battery Charging
Absorb Voltage   28.8 VDC Time 1.0
Float Voltage    27.2 VDC Time 1.0
Equalize Voltage 30.0 VDC Time 3.0
Re-Float Voltage 22.0 VDC
Back             Continue
    
```

```

Wizard AC Configuration
AC Output Voltage 120 VAC
AC Phase          Single
AC Input Breaker Size 60 A
Maximum Output Load 48A
Back             Continue
    
```

```

Wizard Generator Configuration
Generator Installed N
Generator Type     AC Size 5.0 kW
Generator Start    Manual
AUX Output Device Port 1 Control AUX Relay
Back             Continue
    
```

```

Main Menu
Settings          >>
Configuration Wizard >>
Device Data Logs  >>
Event Logs        >>
Firmware Update   >>
    
```

```

Configuration Wizard
New Configuration >>
Existing Configuration >>
Restore Configuration >>
    
```

```

Configuration Wizard
New Configuration Initialized
Back             Continue
    
```

Set Points:

System Type (see page 74):

- **System Type**
- **System Voltage**
- **Array Wattage**
- **Battery Type/Capacity**

Battery Charging (see pages 89 and 89):

- **Absorb Voltage/Time**
- **Float Voltage/Time**
- **Equalize Voltage/Time**
- **Re-Float Voltage**

AC Configuration (See pages 83 - 87, and 100):

- **AC Output Voltage** (Vac)
- **AC Phase**
- **AC Input Breaker Size** (amps)
- **Maximum Output Load** (amps)

Generator Configuration (See pages 74 and 115):

- **Generator Installed** – Y or N
- **Generator Type** – AC or DC
- **Size** – 0.0 to 150.0
- **Generator Start** (manual, auto)
- **Aux Output Device Port** – 1
- **Control** (Radian only; AUX Relay or AUX Output)

Continued on next page...

Figure 162 Creating New Configurations using the Configuration Wizard

...continued from previous page.

Soft Keys:

<Back> moves back one screen.

<Continue> moves forward to the next screen.

Wizard Grid Use Schedule

Period 1 Enable N

Weekday Use 0:00 Drop 0:00

Weekend Use 0:00 Drop 0:00

Back Continue



Wizard Grid Use Schedule

Period 2 Enable N

Weekday Use 0:00 Drop 0:00

Back Continue



Wizard Grid Use Schedule

Period 3 Enable N

Weekday Use 0:00 Drop 0:00

Back Continue



Wizard High Battery Transfer

Mode Disabled

Grid Connect 12.0 VDC Delay 60 Min

Grid Disconnect 13.0 VDC Delay 60 Min

Grid Connect SOC 60% Disconnect SOC 95%

Back Continue



Wizard Battery Monitor

Shunt A

Connection Inverter

Back Continue



Wizard Battery Monitor

Shunt B

Connection Charge Controller

Back Continue



Wizard Battery Monitor

Shunt C

Connection Disabled

Back Continue



Pressing <Continue> from the last setup screen takes the user to the **Setup Complete** screen. See Figure 166 to apply the changes to the system.

Set Points:

Wizard Grid Use Schedule (see page 126):

- **Period 1 Enable - N or Y**
- **Weekday Use - 0:00 Drop 0:00**
- **Weekend Use - 0:00 Drop 0:00**

- **Period 2 Enable - N or Y**
- **Weekday Use - 0:00 Drop 0:00**
- **Weekend Use - 0:00 Drop 0:00**

- **Period 3 Enable - N or Y**
- **Weekday Use - 0:00 Drop 0:00**
- **Weekend Use - 0:00 Drop 0:00**

Wizard High Battery Transfer (See pages 122 and 125):

- **Mode - Y or N**
- **Grid Connect - xx.x VDC Delay xx min**
- **Grid Disconnect - xx.x VDC Delay xx min**
- **Grid Connect SOC xx% Disconnect SOC xx%**

Wizard Battery Monitor (See page 112):

(These screens will only be available if a FLEXnet DC Battery Monitor is installed in the system.)

Shunt A:

- **Connection - Disabled, Inverter, Charge Controller, DC Load, DC Gen, Wind Turbine, Hydro**

Shunt B:

- **Connection - Disabled, Inverter, Charge Controller, DC Load, DC Gen, Wind Turbine, Hydro**

Shunt C:

- **Connection - Disabled, Inverter, Charge Controller, DC Load, DC Gen, Wind Turbine, Hydro**

Figure 162 Creating New Configurations using the Configuration Wizard (continued)

Using Existing Configurations

The **Use Existing Configurations** menu allows the installer to apply a configuration that has previously been saved on the MATE3 to the system being programmed.

To use an existing configuration:

1. Access the **Main Menu** as shown in Figure 71.
2. Select the **Configuration Wizard** menu.
3. Select **Existing Configuration**. This will take the last configuration stored in the MATE3 and apply it to the system.
4. When **Using Existing Configuration** is displayed, press the **<Program>** soft key to start the programming process.
5. Once the program is complete, press **<Exit>** to return to the **Main Menu** or press **<Save>** to save the configuration to an SD card.

See Figure 167 for instructions on saving the configuration to an SD card.

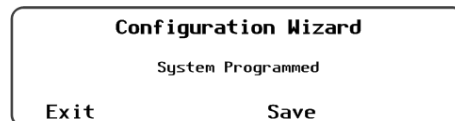
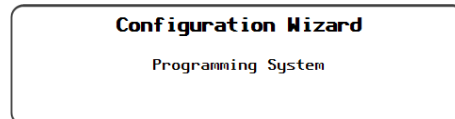
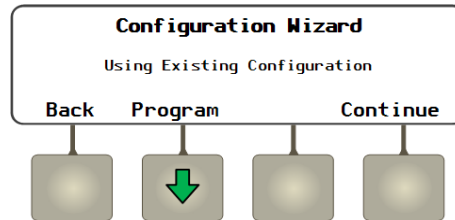
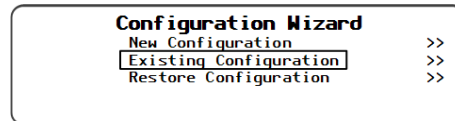
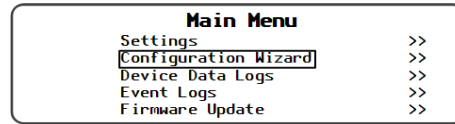

<Exit> returns to the **Main Menu**.

<Save> saves the new profile to an SD card for future use.

Figure 163 Using Existing Configurations using the Configuration Wizard

To modify an existing configuration:

1. Access the **Main Menu** as shown in Figure 71.
2. Select the **Configuration Wizard** menu.
3. Select **Existing Configuration**.
4. Select **<Continue>**. This will bring up the four **Configuration Wizard** programming screens.
5. Use the control wheel to adjust the settings in each screen where required. Record the settings on the form provided in Table 11.

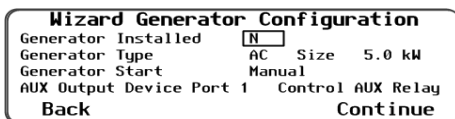
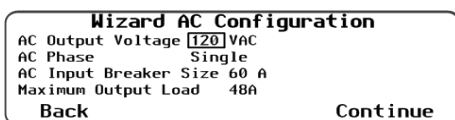
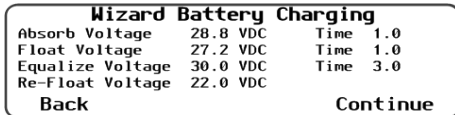
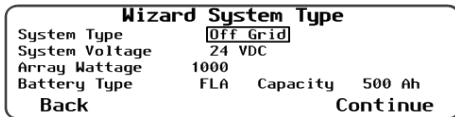
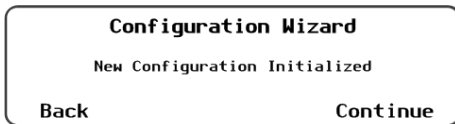
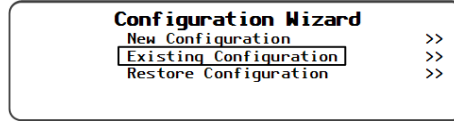
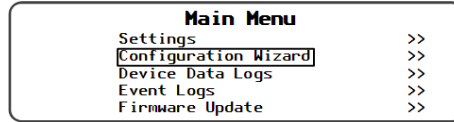

Soft Keys:

<Back> moves back one screen.

<Continue> moves forward to the next screen.

Set Points:

System Type (see page 74):

- **System Type**
- **System Voltage**
- **Array Wattage**
- **Battery Type/Capacity**

Battery Charging (see pages 89 and 89):

- **Absorb Voltage/Time**
- **Float Voltage/Time**
- **Equalize Voltage/Time**
- **Re-Float Voltage**

AC Configuration (See pages 83 - 87, and 100):

- **AC Output Voltage** (Vac)
- **AC Phase**
- **AC Input Breaker Size** (amps)
- **Maximum Output Load** (amps)

Generator Configuration (See pages 74 and 115):

- **Generator Installed** – Y or N
- **Generator Type** – AC or DC
- **Size** – 0.0 to 150.0
- **Generator Start** (manual, auto)
- **Aux Output Device Port** – 1
- **Control** (Radian only; AUX Relay or AUX Output)

Continued on next page...

Figure 164 Modifying an Existing Configuration

...continued from previous page.

Wizard Grid Use Schedule

Period 1 Enable N

Weekday Use 0:00 Drop 0:00

Weekend Use 0:00 Drop 0:00

Back Continue



Wizard Grid Use Schedule

Period 2 Enable N

Weekday Use 0:00 Drop 0:00

Back Continue



Wizard Grid Use Schedule

Period 3 Enable N

Weekday Use 0:00 Drop 0:00

Back Continue



Wizard High Battery Transfer

Mode Disabled

Grid Connect 12.0 VDC Delay 60 Min

Grid Disconnect 13.0 VDC Delay 60 Min

Grid Connect SOC 60% Disconnect SOC 95%

Back Continue



Wizard Battery Monitor

Shunt A

Connection Inverter

Back Continue



Wizard Battery Monitor

Shunt B

Connection Charge Controller

Back Continue



Wizard Battery Monitor

Shunt C

Connection Disabled

Back Continue



Pressing **<Continue>** from the last setup screen takes the user to the **Setup Complete** screen. See Figure 166 to apply the changes to the system.

Soft Keys:

- **<Back>** moves back one screen.
- **<Continue>** moves forward to the next screen.

Set Points:

Wizard Grid Use Schedule (see page 126):

- **Period 1 Enable - N or Y**
- **Weekday Use - 0:00 Drop 0:00**
- **Weekend Use - 0:00 Drop 0:00**

- **Period 2 Enable - N or Y**
- **Weekday Use - 0:00 Drop 0:00**
- **Weekend Use - 0:00 Drop 0:00**

- **Period 3 Enable - N or Y**
- **Weekday Use - 0:00 Drop 0:00**
- **Weekend Use - 0:00 Drop 0:00**

Wizard High Battery Transfer (See pages 122 and 125):

- **Mode - Y or N**
- **Grid Connect - xx.x VDC Delay xx min**
- **Grid Disconnect - xx.x VDC Delay xx min**
- **Grid Connect SOC xx% Disconnect SOC xx%**

Wizard Battery Monitor (See page 112):

(These screens will only be available if a FLEXnet DC Battery Monitor is installed in the system.)

Shunt A:

- **Connection - Disabled, Inverter, Charge Controller, DC Load, DC Gen, Wind Turbine, Hydro**

Shunt B:

- **Connection - Disabled, Inverter, Charge Controller, DC Load, DC Gen, Wind Turbine, Hydro**

Shunt C:

- **Connection - Disabled, Inverter, Charge Controller, DC Load, DC Gen, Wind Turbine, Hydro**

Figure 164 Modifying an Existing Configuration (continued)

Restoring Configurations

Restoring configurations allows the installer to restore a system back to a profile that had been saved on an SD card.

To restore a profile from an SD Card:

1. Access the **Main Menu** as shown in Figure 71.
2. Select the **Configuration Wizard** menu.
3. Select **Restore Configuration**. The MATE3 will access the SD card and display the names of the profiles that are available on the SD card to be restored.
4. Use the control wheel to scroll through the names.
5. When the desired profile is selected, press the **<RESTORE>** soft key to start the restoration process. This will give the installer the opportunity to go through each configuration screen to confirm it is accurate. Use the control wheel to adjust the settings in each screen where required. Record the settings on the form provided in Table 11.
4. Press **<Continue>** to advance to the next screen.

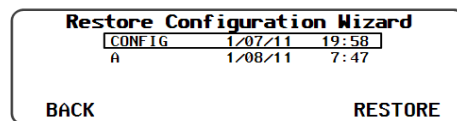
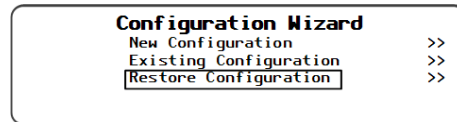
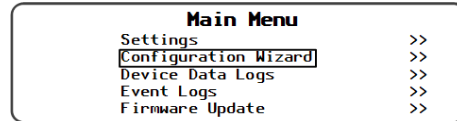

Soft Keys:

<Back> moves back one screen.

<Continue> moves forward to the next screen.

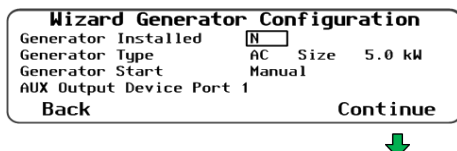
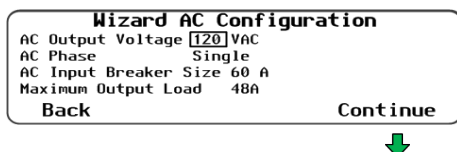
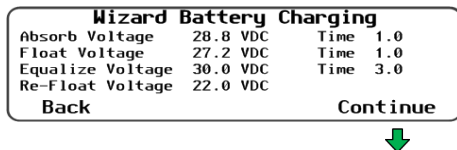
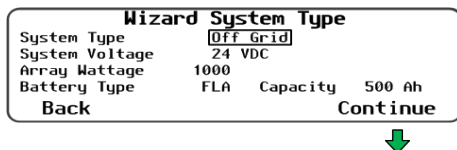

Set Points:

System Type (see page 74):

- > **System Type**
- > **System Voltage**
- > **Array Wattage**
- > **Battery Type/Capacity**

Battery Charging (see pages 89 and 89):

- > **Absorb Voltage/Time**
- > **Float Voltage/Time**
- > **Equalize Voltage/Time**
- > **Re-Float Voltage**

AC Configuration (See pages 83 - 87, and 100):

- > **AC Output Voltage** (Vac)
- > **AC Phase**
- > **AC Input Breaker Size** (amps)
- > **Maximum Output Load** (amps)

Generator Configuration (See pages 74 and 115):

- > **Generator Installed** – Y or N
- > **Generator Type** – AC or DC
- > **Size** – 0.0 to 150.0
- > **Generator Start** (manual, auto)
- > **Aux Output Device Port** – 1

...continued on next page.

Figure 165 Restoring Configurations

...continued from previous page.

Wizard Grid Use Schedule

Period 1 Enable N

Weekday Use 0:00 Drop 0:00

Weekend Use 0:00 Drop 0:00

Back Continue



Wizard Grid Use Schedule

Period 2 Enable N

Weekday Use 0:00 Drop 0:00

Back Continue



Wizard Grid Use Schedule

Period 3 Enable N

Weekday Use 0:00 Drop 0:00

Back Continue



Wizard High Battery Transfer

Mode Disabled

Grid Connect 12.0 VDC Delay 60 Min

Grid Disconnect 13.0 VDC Delay 60 Min

Grid Connect SOC 60% Disconnect SOC 95%

Back Continue



Wizard Battery Monitor

Shunt A

Connection Inverter

Back Continue



Wizard Battery Monitor

Shunt B

Connection Charge Controller

Back Continue



Wizard Battery Monitor

Shunt C

Connection Disabled

Back Continue



Pressing <Continue> from the last setup screen takes the user to the **Setup Complete** screen. See Figure 166 to apply the changes to the system.

Soft Keys:

- <Back> moves back one screen.
- <Continue> moves forward to the next screen.

Set Points:

Wizard Grid Use Schedule (see page 126):

- **Period 1 Enable - N or Y**
- **Weekday Use - 0:00 Drop 0:00**
- **Weekend Use - 0:00 Drop 0:00**

- **Period 2 Enable - N or Y**
- **Weekday Use - 0:00 Drop 0:00**
- **Weekend Use - 0:00 Drop 0:00**

- **Period 3 Enable - N or Y**
- **Weekday Use - 0:00 Drop 0:00**
- **Weekend Use - 0:00 Drop 0:00**

Wizard High Battery Transfer (See pages 122 and 125):

- **Mode - Y or N**
- **Grid Connect - xx.x VDC Delay xx min**
- **Grid Disconnect - xx.x VDC Delay xx min**
- **Grid Connect SOC xx% Disconnect SOC xx%**

Wizard Battery Monitor (See page 112):

(These screens will only be available if a FLEXnet DC Battery Monitor is installed in the system.)

Shunt A:

- **Connection - Disabled, Inverter, Charge Controller, DC Load, DC Gen, Wind Turbine, Hydro**

Shunt B:

- **Connection - Disabled, Inverter, Charge Controller, DC Load, DC Gen, Wind Turbine, Hydro**

Shunt C:

- **Connection - Disabled, Inverter, Charge Controller, DC Load, DC Gen, Wind Turbine, Hydro**

Figure 165 Restoring Configuration (continued)

Applying the Profile to the System

Once the configuration parameters are complete, *the settings must be applied to the system.*

To apply the profile to the system:

- From the **Setup Complete** screen, press **<Program>**.

NOTE:

- Pressing **<Exit>** at this point *WILL NOT* save the changes to the MATE3 internal memory and all changes will be lost.
- Pressing **<Save>** at this point will proceed to the **Save Configuration Wizard** screen (Figure 167) *WITHOUT* applying the profile to the system and the changes will be lost.

- Wait while the settings are applied to the system. The screen will display **Programming System**. When this step is complete, the screen will display **System Programmed**.

- When the screen displays **System Programmed**, choose one of the following options.

- Press **<Exit>** to return to the **Main Menu**, or
- Press **<Save>** to save the configuration on an SD card for future use. See Figure 167.

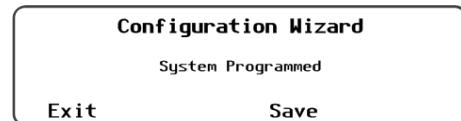
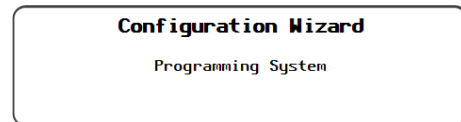

Figure 166 Applying the Profile to the System



IMPORTANT:

Failure to apply the profile to the system as described above can result in the settings not being saved to the MATE3's internal flash memory. This can result in the system not being programmed properly.

Saving the Profile to an SD Card

Once the settings are applied to the system, they can be saved to an SD card for future use.

To save a configuration to an SD card:

- From the **System Programmed** screen (see Figure 163), press **<Save>**. The **Save Configuration Wizard** screen will appear.
- If other profiles have been saved on the SD card, a list will be displayed. Choose one of the following options.
 - Press **<Save>** to save the new settings over the name that is selected on the list.
OR
 - Press **<New>** to create a new name for the profile. See the instructions below for entering a new name.
OR
 - Press **<Exit>** to exit *without* saving and returns the user to the **Main Menu**.
- After saving the profile to the SD card is complete, press **<Continue>** to return to the **Main Menu**.

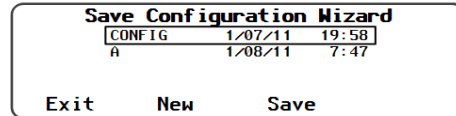
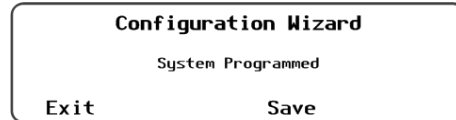

NOTE: If the SD card is empty, pressing **<Save>** will automatically default to the **New Wizard Configuration File** menu to allow a name to be entered (up to 8 characters maximum).

To save the new profile over the name highlighted on the list:

- Use the control wheel to scroll through the list.
- When the name to be replaced is highlighted, press **<Save>**.
- Wait for the message confirming that the profile has been saved to the SD card.
- Press **<Continue>** to return to the **Main Menu**.

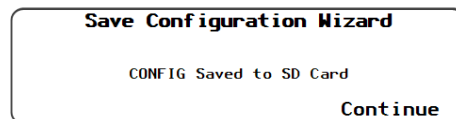
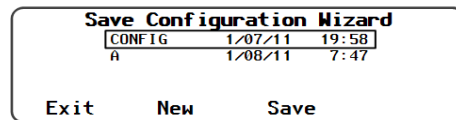

Returns to the **Main Menu**.

To create a new name for the profile (up to 8 characters maximum):

- Use the control wheel to scroll through the available characters.
- Use **<→>** or **<←>** to move to the desired character location.
- Press **<Delete>** to erase the character that is highlighted.
- Press **<Save>** to save the new profile on the SD card.
- Press **<Continue>** to return to the **Main Menu**.

See the sample data log on page 141.

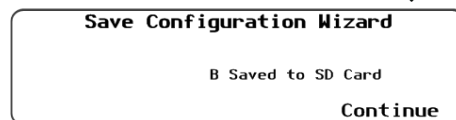
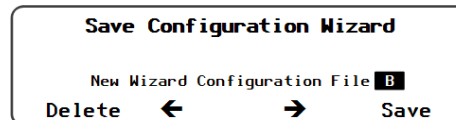
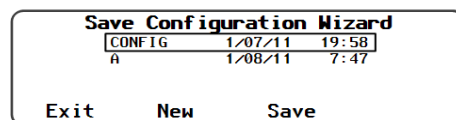

Returns to the **Main Menu**.

Figure 167 Saving the Configuration to an SD Card

Device Data Logs

Users can create Device Data Logs for the FLEXmax (FM) Charge Controller and the FLEXnet (FN) DC Battery Monitor. The Data Logs can then be uploaded and saved to an SD card.

Saving Data Logs for the FLEXmax Charge Controller

To create a data log for the FLEXmax Charge Controller:

1. Access the **Main Menu** as shown in Figure 71.
2. Select the **Device Data Logs** menu.
3. Select **FLEXmax Charge Controller** menu.
4. Select **Upload and Save Data Log** on the **FM Charge Controller Data Log** menu.
5. Select one of the two options.
 - Press **<New>** to give the new data log a unique name. Or
 - Press **<Save>** to save the data log over the name that is highlighted on the list.
6. After saving the data log is complete, press **<Continue>** to return to the **Upload and Save Data Log** screen.

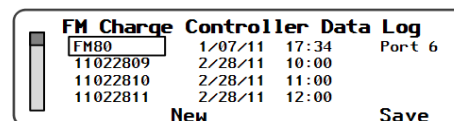
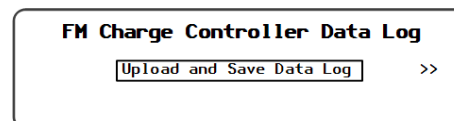
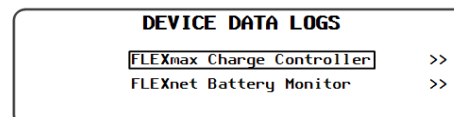
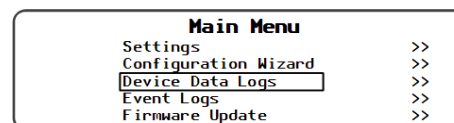

To save a new data log over the name highlighted on the list:

1. Use the control wheel to scroll through the list.
2. When the name to be replaced is highlighted, press **<Save>**.
3. Wait for the message confirming that the profile has been saved to the SD card.
4. Press **<Continue>** to return to the **Upload and Save Data Log** menu.

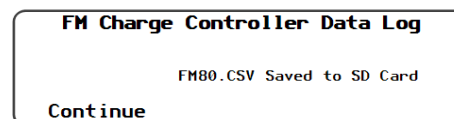
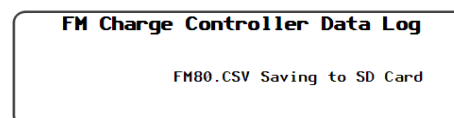

Returns to the **Upload and Save Data Log** screen.

To create a new name for the data log (up to 8 characters maximum):

1. Use the control wheel to scroll through the available characters.
2. Use **<=>** or **<←>** to move to the desired character location.
3. Press **<Delete>** to erase the character that is highlighted.
4. Press **<Save>** to save the new data log on the SD card.
4. Press **<Continue>** to return to the **Upload and Save Data Log** menu.

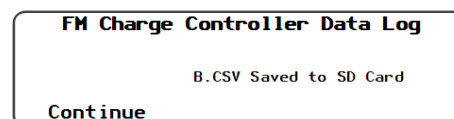
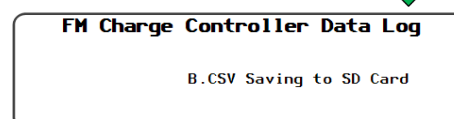
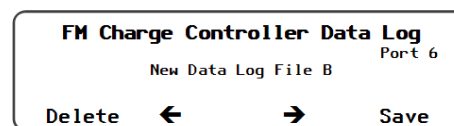

Returns to the **Upload and Save Data Log** screen.

See the sample data log on page 141.

Figure 168 Uploading and Saving a Data Log for the FM Charge Controller

The FLEXnet DC Battery Monitor offers the ability to both upload and save a data log or to erase a data log.

Saving Data Logs for the FLEXnet (FN) Battery Monitor

To create a Data Log for the FN Battery Monitor:

1. Access the **Main Menu** as shown in Figure 71.
2. Select the **Device Data Logs** menu.
3. Select **FLEXnet Battery Monitor** menu.
4. Select **Upload and Save Data Log** on the **FN Battery Monitor Data Log** menu. The system will display a list of all the data logs that have been recorded.
5. Select one of the two options.
 - Press **<New>** to give the new data log a unique name. Or
 - Press **<Save>** to save the data log over the name that is highlighted on the list.
6. After saving the data log is complete, press **<Continue>** to return to the **Upload and Save Data Log** screen.

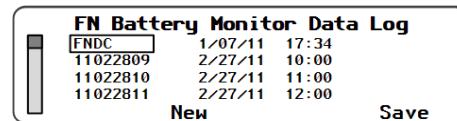
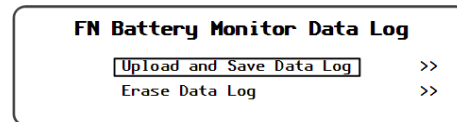
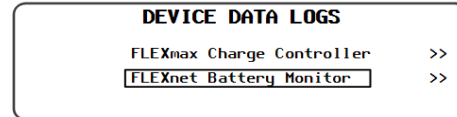
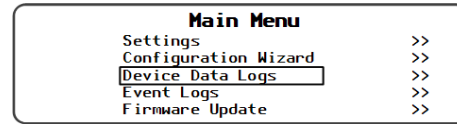

To save a new data log over the name highlighted on the list:

1. Use the control wheel to scroll through the list.
2. When the name to be replaced is highlighted, press **<Save>**.
3. Wait for the message confirming that the profile has been saved to the SD card.
4. Press **<Continue>** to return to the **Upload and Save Data Log** menu.

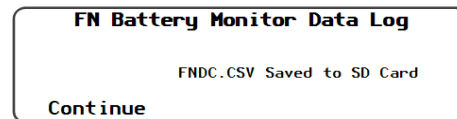
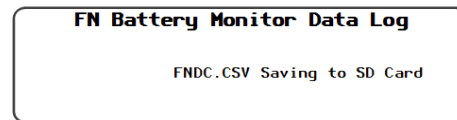

Returns to the **Upload and Save Data Log** screen.

To create a new name for the data log (up to 8 characters maximum):

1. Use the control wheel to scroll through the available characters.
2. Use **<→>** or **<←>** to move to the desired character location.
3. Press **<Delete>** to erase the character that is highlighted.
4. Press **<Save>** to save the new data log on the SD card.
4. Press **<Continue>** to return to the **Upload and Save Data Log** menu.

See the sample data log on page 141.

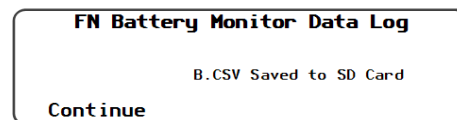
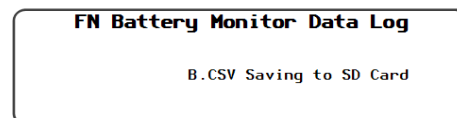
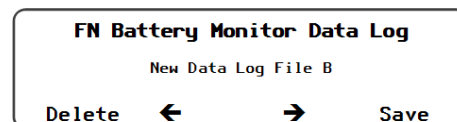

Returns to the **Upload and Save Data Log** screen.

Figure 169 Uploading and Saving a Data Log for the FLEXnet DC Battery Monitor

Erasing Data Logs for the FLEXnet Battery Monitor

To erase a Data Log for the FLEXnet DC Battery Monitor:

1. Access the **Main Menu** as shown in Figure 71.
2. Select the **Device Data Logs** menu.
3. Select **FLEXnet Battery Monitor**.
4. Select **Erase Data Log** on the **FN Battery Monitor Data Log** menu.
5. Select **<Yes>** to erase the data log. Press **<No>** to return to the **FN Battery Monitor Data Log** menu. Press **<Continue>** to return to the **Main Menu**.

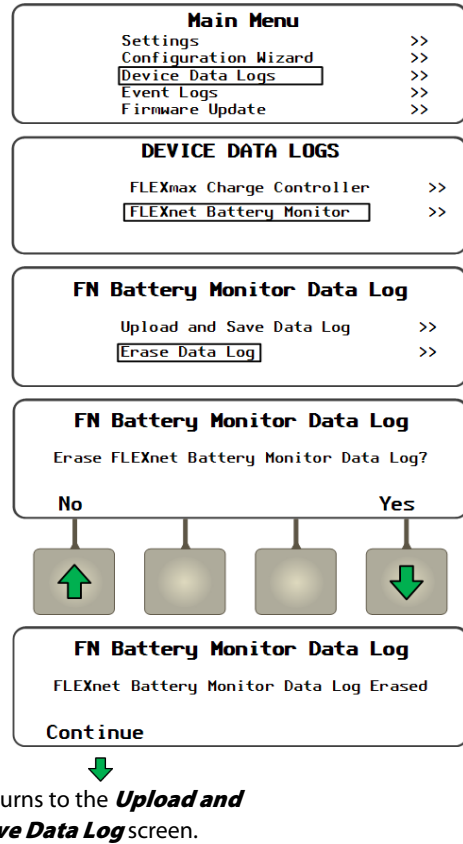

Figure 170 Erasing a Data Log for the FLEXnet DC Battery Monitor

NOTE: This header line is included in the download.

Date	AH	Kwh	Max Amps	Max Watts	Absorb Time	Float Time	Min Battery V	Max Battery V	MAX VOC
6/13/11	0	0	1.2	29	0:00	0:00	24.1	29.1	122
6/12/11	38	0.9	5.5	143	0:00	0:00	24.1	29	122
6/11/11	32	0.8	5.6	144	0:00	0:00	24.1	28.7	120

Figure 171 Data Log Example for the Charge Controller

NOTE: This header line is included in the download.

Date	In AH	In kWh	Out AH	Out kWh	Net AH	Net kWh	Min SOC
6/13/11	0	0	1	0.01	-1	-0.01	99
6/12/11	81	2.17	9	0.11	72	2.06	98
6/11/11	63	1.67	9	0.12	54	1.55	98

Figure 172 Data Log Example for the FLEXnet DC Battery Monitor

Event Logs

When events occur that affect the system or cause a shutdown, an event message occurs. Events are recorded at intervals to the MATE3 flash memory at intervals programmed in the MATE3 settings. (See Figure 153 on page 122.)

- Event notifications are shown Figure 158 on page 150.
- How to review event messages is shown in Figure 159 on page 151.

Event logs can be downloaded to an SD Card or deleted from the MATE3 internal memory.

To Save an Event Log

To save an event log:

1. Access the **Main Menu** as shown in Figure 71.
2. Select the **Event Logs** menu.
4. Select **Save Events to SD Card**.
5. On the **Date Range** set point, use the control wheel to select the date for the event log (or logs) to be saved to the SD card. The range will start with "**All**" and will move backward to **yesterday**, up to one year's worth of logs.
6. If a log with a specific date is desired, then use the control wheel to scroll through the list. When the name to be saved is selected, press **<Continue>**.
7. After performing the desired action, press **<Continue>** to return to the **Event Logs** menu.

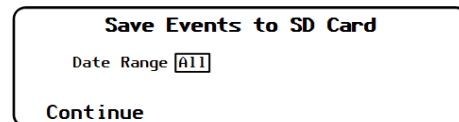
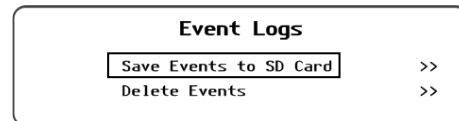
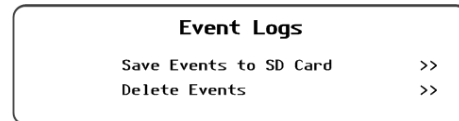
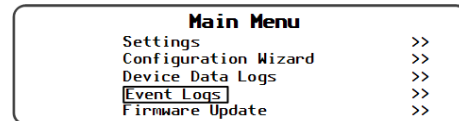

To save an event log over the name highlighted on the list:

1. With the correct name highlighted, press **<Save>**.
2. Wait for the message confirming that the event log has been saved to the SD card.
3. After the save action is complete, press **<Continue>** to return to the **Event Logs** menu.

NOTE: If the SD card is empty, pressing **<Save>** will automatically default to the **New Data Log File** menu to allow a name to be entered (up to 8 characters maximum).

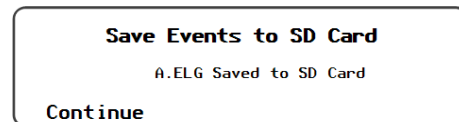
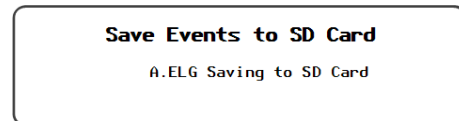
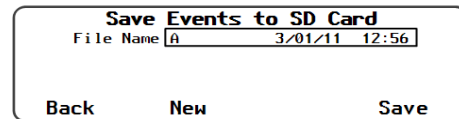

Returns to the **Event Logs** screen.

Continued on the next page...

Figure 173 Saving Event Logs

To create a new name for the Event Log (up to 8 characters maximum):

1. On the **Date Range** set point, use the control wheel to select the date for the event log (or logs) to be uploaded to the SD card. The range will start with "**All**" and will move backward to **yesterday**, up to one year's worth of logs.
2. If a log with a specific date is desired, then use the control wheel to scroll through the list. When the name to be uploaded is selected, press **<Continue>**.
3. To create a new name for the log:
 - ~ Use the control wheel to scroll through the available characters.
 - ~ Use **<=>** or **<<=>** to move to the next character location.
 - ~ Press **<Delete>** to erase the character that is highlighted.
4. Press **<Save>** to save the new Event Log on the SD card.
5. Press **<Continue>** to return to the **Upload and Save Data Log** menu.

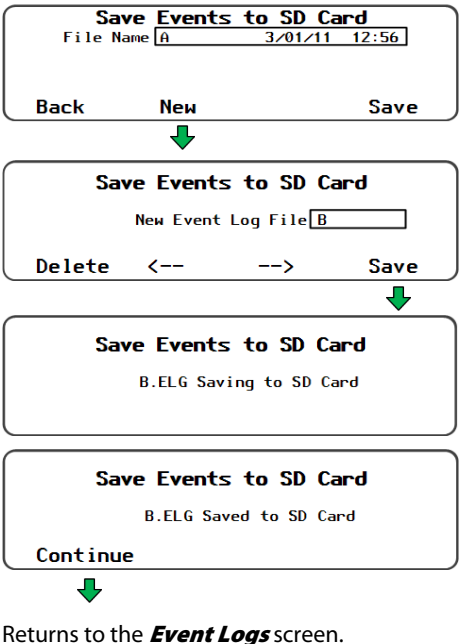

Figure 173 Saving Event Logs (continued)

To Read an Event Log File from the SD Card

When an Event Log is downloaded to an SD card, an **.elg** file is created. This file can be opened in Notepad or MS Word as a text file.

```
6/16/11,12:16:09,FX-1,IN AC Voltage OK,119 VAC
6/16/11, 6:25:13,Remote Power Down
6/16/11, 6:25:13,Remote Power Up
6/09/11,15:36:55,Remote Power Down
6/09/11,15:40:08,Remote Power Up
6/08/11,10:51:44,Remote Power Down
6/08/11,15:31:14,Remote Power Up
6/08/11,10:28:02,Remote Power Down
6/08/11,10:28:43,Remote Power Up
6/07/11,14:31:59,Remote Power Down
6/07/11,14:32:09,Remote Power Up
6/07/11, 9:45:30,Remote Power Down
6/07/11, 9:45:38,Remote Power Up
6/06/11, 9:12:59,Remote Power Up
5/31/11,15:35:01,Remote Power Down
5/31/11,15:35:21,Remote Power Up
5/31/11,15:37:10,FX-1,IN AC Freq Too High, 0.0 Hz
5/31/11,15:37:10,FX-1,IN AC Voltage Too Low, 0 VAC
5/31/11,15:37:10,FX-1,IN AC Current Too High,127 A
5/31/11,15:37:12,FX-1,IN AC Freq OK, 0.0 Hz
5/31/11,15:37:16,FX-1,IN AC Current OK, 0 A
5/31/11,15:37:30,FX-1,IN AC Voltage OK, 63 VAC
5/31/11,15:34:51,FX-1,IN AC Voltage Too Low, 0 VAC
5/31/11,10:11:37,Remote Power Down
5/31/11,10:11:41,Remote Power Up
```

Figure 174 Sample Event Log from an SD Card

To Delete an Event Log

To Delete an Event Log:

1. Access the **Event Logs** menu as shown in Figure 173.
2. On the **Date Range** set point, use the control wheel to select the date for the event log (or logs) to be deleted. The range will start with "**All**" and will move backward to **yesterday**, up to one year's worth of logs.
3. If a log with a specific date is desired, then use the control wheel to scroll through the list. When the name to be deleted is selected, press **<Continue>**.
4. Press **<Yes>** to delete event log on the SD card.
5. Select one of the two options.
 - Press **<Yes>** to delete the event log. Or
 - Press **<No>** to return to the **Date Range** screen and select a different event log.
6. Pressing **<Yes>** in step 5 above will delete the selected event log. Wait while the MATE3 completes this action.
7. Once the **Events Deleted** confirmation screen appears, press **<Continue>** to return to the **Event Logs** menu.

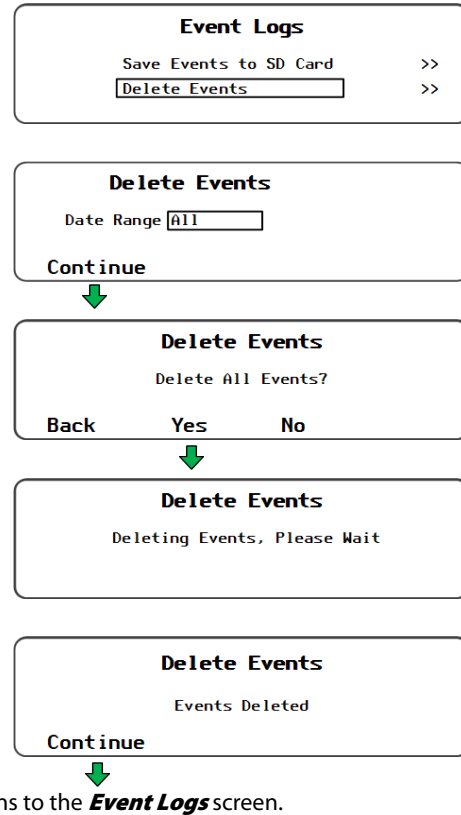

Figure 175 Deleting Event Logs

Firmware Update

The **Firmware Update** screen enables the MATE3 to download the latest firmware revision from an SD Memory Card (included). The MATE3 and the Radian inverter can be upgraded this way. Other devices may be able to be upgraded in the future.

Saving the Update to the SD Card

To copy the latest firmware update to the SD card:

1. Go to the OutBack web site to locate the MATE3 or Radian firmware download.
<http://outbackpower.com/>
<http://www.outbackpower.com/products/communications/mate3/>
2. Look for the hyperlinks shown in Figure 176 or Figure 177. Click on the link to initiate the download.
3. When the **File Download** window appears, select **SAVE** and save the compressed file to the computer. (See Figure 178.)
4. Extract all the files from the compressed file and copy the extracted files to the SD card. Follow the instructions on page 147 to install the update to the MATE3.

Click here to start the download.

NOTE:
This icon may be located on several different pages within the web site.

Figure 176 Download Firmware from Home Page

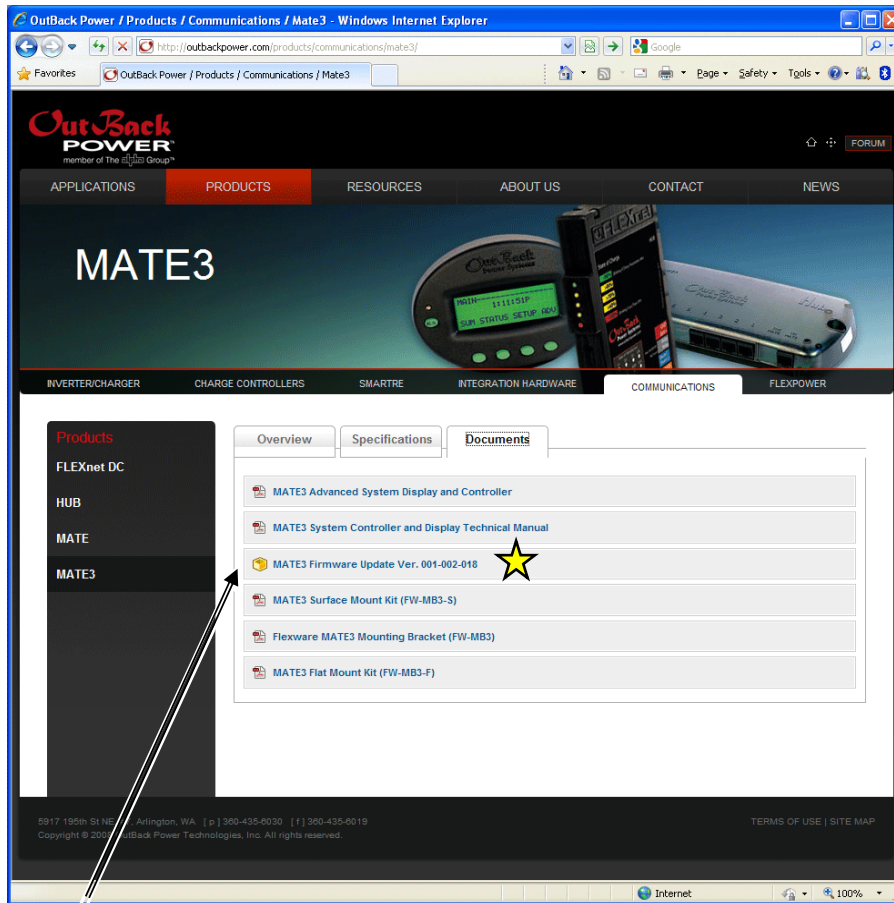

 [MATE3 Software Update Ver. 001-002-018](#)

Click here to start the download.

NOTE:

The version represented in this illustration may be different than the version offered on the web site. Always use the most current version of firmware.

The web pages, or the links to access them, may not be identical to those shown here. Follow any appropriate instructions for downloading.

Figure 177 Download Firmware from Web Page



Click here to save the file to the computer.



NOTE:

Extract the files from the compressed folder before copying to the SD card.

Figure 178 Saving the File

Installing the Firmware Update



IMPORTANT:

- When updating the Radian inverter, pressing **Update** will command all connected Radian inverters to turn OFF.
- Updating the firmware will not reset the MATE3 to factory defaults.

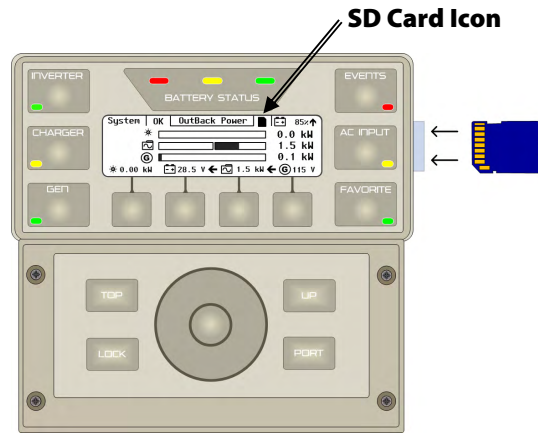

To install the Firmware Update:

1. Power up the MATE3 by connecting the CAT5 cable from the system to the MATE3.
2. Insert the SD memory card.
3. Access the **Main Menu** as shown on page 71.
4. From the **Main Menu** screen, select **Firmware Update**.
5. From the **Firmware Update** screen, select **MATE3**, **GS Inverter**, or the appropriate device. A Firmware Update screen will appear for that device. (**MATE3 Firmware Update** is shown.)
6. From the **Firmware Update** screen, press **<Update>**.
7. The screen will show **Updating Main Processor**. The yellow battery LED will flash rapidly. Radian will be updated from the highest port number to the lowest.

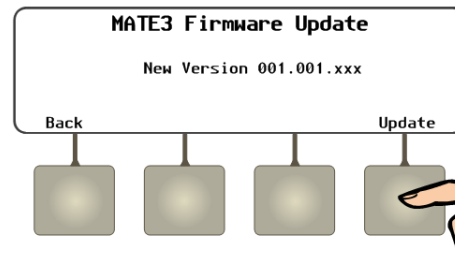
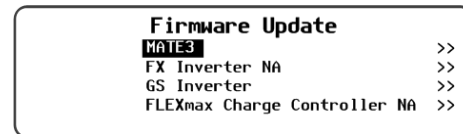

When updating the MATE3: Once the update is complete, the MATE3 will automatically reboot itself and return to the Home screen.

When updating the Radian inverter, the **GS Firmware Update** screen will display all inverters updated. The user will need to manually turn the inverters back on.

The firmware update is complete.

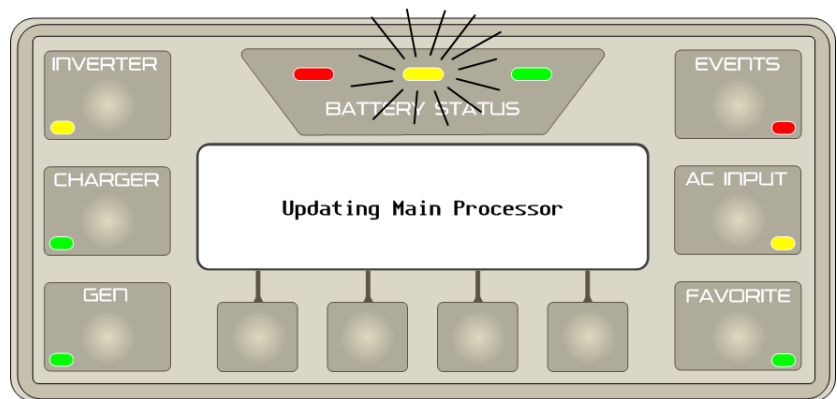

Figure 179 Installing the Firmware Update



Troubleshooting

Basic Troubleshooting of the MATE3

Table 4 Basic Troubleshooting

Symptom	Possible Cause	Remedy
MATE3 does not power up.	The MATE3 is powered by the OutBack product to which it is connected. Make sure that all OutBack products are powered up and operating correctly before connecting the MATE3.	Check or replace the CAT5 cable running from the MATE3 to the OutBack product.
	The left-hand RJ45 port on the back of the MATE3 is used for computer communications. It cannot power a MATE3.	Make sure the CAT5 cable is plugged into the correct RJ45 port (the right-hand port).
HUB loses power when cable is plugged into MATE.	The left-hand RJ45 port on the back of the MATE3 is wired differently and may short out a HUB.	Make sure the CAT5 cable is plugged into the correct RJ45 port (the right-hand port).
MATE3 does not display a particular device, meter, or setting.	Make sure that all OutBack products are powered-up and operating correctly before connecting the MATE3.	Check or replace the CAT5 cable running from the MATE3 to the OutBack product. If a HUB product is being used, make sure no OutBack products have been moved, unplugged, or added.
MATE3 voltmeter for a particular device or screen is inaccurate.	Meter could be incorrectly calibrated.	Confirm correct voltage with an accurate voltmeter. (Make all tests on the terminals of the OutBack product.) If necessary, adjust the MATE3 meter using the Calibration menus.
The router doesn't recognize the MATE3.	Communication incompatibility between the router and the MATE3 (i.e., there may be two devices on the network with the same IP address.)	Enable DHCP. Power cycle the MATE3 by unplugging the communications cable from the HUB. Then note the new IP address. Go back to the same screen and Disable DHCP and use those new numbers to manually program the port forwarding and static IP address for the MATE3 on the router. See page 78.

Event Messages

The Events LED indicates that an event has occurred which requires attention. If this LED illuminates, follow the steps illustrated in Figure 181 to help determine the nature of the fault. This may also help resolve it.

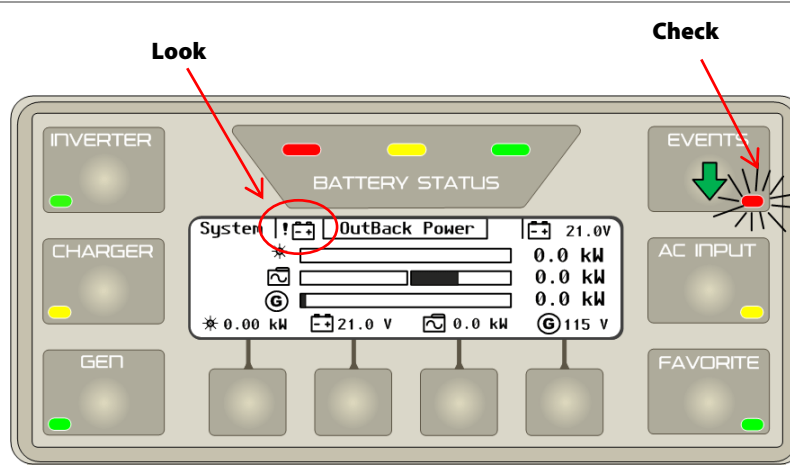

System Indicator Legend	
OK	System Operational
!	Check Battery (with FNDOnly)
X	Battery Critical (with FNDOnly)
!	Check Generator (Off Grid system type only)
!	Check Inverter
!	Check Utility Grid (with a Grid Tied system type only)

These system indicators are often specific to certain products or system configurations, as noted in the table. See pages 34 through 36 for details.

Figure 180 Event Notification

To investigate event messages:

1. Look at the system indicator. The icon will change to indicate the device that needs attention. See the Legend in Figure 180.
2. Check the LED.
 - ~ Flashing means a Warning has occurred. (See page 42 for a list of Warnings.)
 - ~ Solid may mean that the system has suffered an AGS fault (see page 61), or has shut down due to an Error (see page 43).
3. Press the **EVENTS** key to display the **Event Status** screen.
4. The Event History screen will appear with a list of events that have occurred.
 - ~ Press **<Next>** to select the next event in the list.
 - ~ Press **<Prev>** to select the previous event in the list.
 - ~ Press **<Back>** to return to the Home screen.
5. To view the detail about an event, press **<Details>** when the desired event is highlighted in the list.
 - ~ Press **<Back>** to return to the **Event History** screen.
 - ~ Press **<Back>** again to return to the Home screen.
6. If the event involves another device within the system, then refer to that device's manual for troubleshooting advice and resolve the issue accordingly.

NOTE:

The control wheel will also scroll up and down the list in the **Event History** screen.

NOTE:

Using the control wheel in the **Event History Detail** screen will display the detail for the previous, or the next, event as listed in the **Event History** screen.

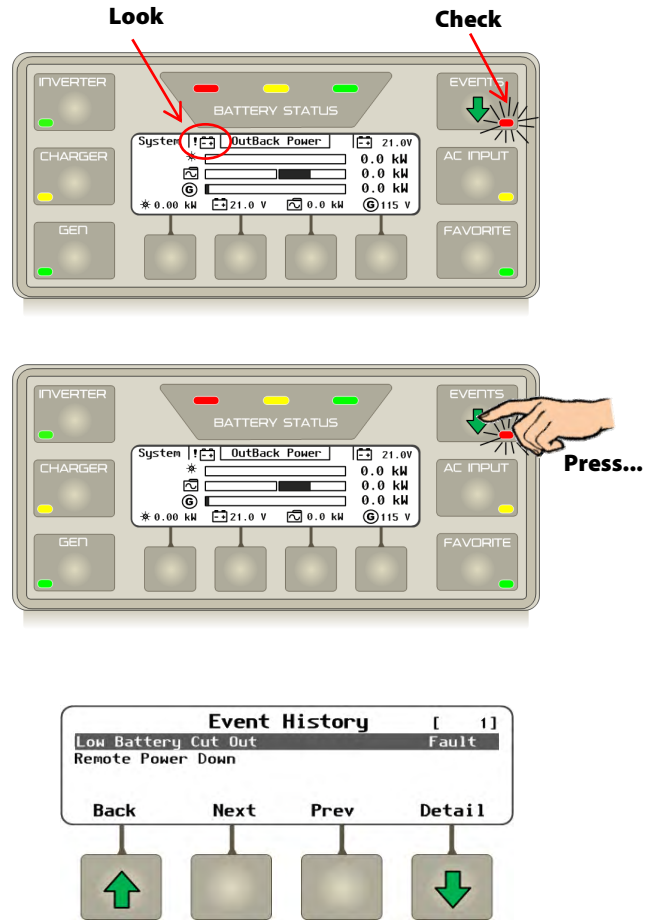

Soft Key Options:

<Back> returns to the Home screen.

<Next> highlights the next event in the list.

<Prev> highlights the previous event in the list.

<Detail> displays the details of the selected event, and prompting for acknowledgement, if necessary.

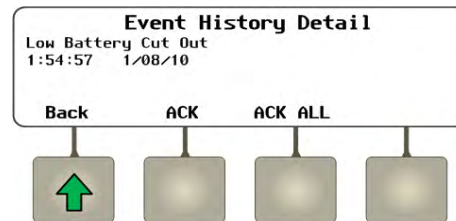

Soft Key Options:

<Back> returns to the **Event History** screen.

<ACK> will acknowledge one open event.

<ACK ALL> will acknowledge all open events.

Figure 181 Reviewing Event Messages

Start and Stop Reasons for the AGS Function

The first two columns in this table is the list of Automatic Generator Start reasons which may be displayed in the **Gen** hot key screen as shown in Figure 54. The remaining columns display all possible reasons for the generator to automatically stop. The possible stop reasons are related to the start reason.

For example, a generator which started due to **Load kW** can stop due to reduction of load kilowatts, due to Quiet Time, or manually, but it will not stop due to SOC or for any of the other reasons.

Table 5 AGS Start and Stop Reasons

		STOP REASONS								
		Inverter in Float or Silent	Stop SOC %	Stop at 100% SOC	FNDC Charge Parms Met (CPM)	Below Load kW	Quiet Time	Exercise Time Expires	Manual Stop	High Bat Voltage
START REASONS	Global Rebulk									
2 Min Batt V	yes	stop			Stop				stop	stop
2 Hour Batt V	yes	stop	Stop if days since CPM < setting	Stop if days since 100% SOC > setting	Stop if days since CPM > setting		stop		stop	stop
24 Hour Batt V	yes	stop	Stop if days since CPM < setting	Stop if days since 100% SOC > setting	Stop if days since CPM > setting		stop		stop	stop
Start Soc%	yes	stop	Stop if days since CPM < setting	Stop if days since 100% SOC > setting	Stop if days since CPM > setting		stop		stop	stop
Load kW						stop	stop		stop	
Exercise							stop	stop	stop	
Must Run Start	yes						stop		stop	stop
Manual Start	yes	if auto selected	if auto selected						stop	

NOTES:

- "Setting" refers to the "Interval Days" setting in the State of Charge Start screen as depicted in Figure 127.
- CPM, or Charged Parameters Met, refers to the FNDC's full-charge parameters as defined on page 48.
- The conditions of the "Inverter In Float or Silent" column will stop the generator if the inverter reaches these stages before the conditions of the other columns take effect.
- The conditions of the Stop SOC% column apply as long as "Days Since Parms Met" does not exceed "Interval Days". The generator will be shut off upon reaching the "Stop SOC%" setting as shown in Figure 127.
- The conditions of the Stop at 100% SOC column apply if "Days Since Parms Met" equals or exceeds "Interval Days." The generator will ignore the Stop SOC% setting and continue running until the battery SOC is at 100%. (This function does not operate if Enable Full Charge is set at N, or if the Interval is set at 0.)
- The conditions of the FNDC Charge Parms Met (CPM) column apply when "Days Since Parms Met" equals or exceeds "Interval Days" and Enable Full Charge (100% SOC) is disabled as noted above. These conditions also apply if for any reason the charge parameters are not met when the batteries reach 100% SOC as noted above. The generator will continue to run until the FNDC's charge parameters have been met.



Specifications

Mechanical Specifications

Mechanical Specification	MATE3
Dimensions (H x W x D)	7 1/2" x 7 1/16" x 1 5/8" (19 x 17.9 x 4.2 cm)
Shipping Dimensions (H x W x D)	3 1/4 x 9 x 13 1/2" (33.7 x 22.9 x 34.3 cm)
Weight	1.4 lb (0.64 kg)
Shipping Weight	3.0 lb (1.36 kg)
Ports	RJ45 for proprietary OutBack HUB communication (x1) RJ45 Ethernet port (x1)
Nonvolatile Memory	64 Mb (for internal data logs and MATE3 configuration settings)
Interface Display	Liquid Crystal Display (LCD)
Control Keypad	4 soft keys 6 hot keys 4 navigation keys 1 control wheel with Enter button
Status Indicators	9 LEDs
Battery (for real-time clock and internal memory)	CR2032
Communication Protocol	Proprietary OutBack network
Interconnection Cabling Standard	Category 5 OutBack proprietary
PC Computer Interface	Category 5
Environmental Rating	Indoor only
Warranty Standard	5-year

Regulatory Specifications

Table 6 Regulatory Specifications for All Models

Regulatory Specification	Model
Emissions	FCC Class B
Regulatory	UL 1741 1st Edition; 2005 Version, CSA 107.1-01, CE Conformance European EN 55022 Class B

Firmware Revision

This manual applies to MATE3 System Display and Controllers with a firmware version of 002.006.xxx or higher.

FCC Information to the User

This equipment has been tested and found to comply with the limits for a Class B digital device when powered by a DC source, pursuant to part 15 of the FCC Rules. These limits are designed to provide reasonable protection against harmful interference in a residential installation. This equipment generates uses and can radiate radio frequency energy and, if not installed and used in accordance with the instructions, may cause harmful interference to radio communications. However, there is no guarantee that interference will not occur in a particular installation. If this equipment does cause harmful interference to radio or television reception, which can be determined by turning the equipment off and on, the user is encouraged to try to correct the interference by one or more of the following measures:

- Reorient or relocate the receiving antenna.
- Increase the separation between the equipment and the receiver.
- Consult the dealer or an experienced radio/TV technician for help.

Table 7 Installer Settings (System Settings)

Menu	Menu Option	Menu Items	Set Points	Installer Settings	Page
Settings	System	System Information	Type		74
			Nominal Voltage		
			Array Wattage		
			Battery Amp-hours		
			Generator kW		
			Generator Type		
			Max Inverter kW		
			Max Charger kW		
		Save / Restore Configuration	Save Configuration		75
			Restore Configuration		76
		Firmware Revision	N/A		76
		Date and Time	Hour		77
			Minutes		
			Day		
			Month		
			Year		
			Day of Week		
		LCD Display	Contrast		77
			Color		
			Brightness		
			Backlight		
			Auto Timeout		
		Sound	Button Beep		78
Wheel Click					
Ethernet Addresses	DHCP		78		
	IP Address				
	Netmask				
	Gateway				
	DNS-1				
	DNS-2				
Ethernet Ports	HTTP		79		
	FTP				
	Telnet				

Installer Settings

Table 7 Installer Settings (System Settings)

Menu	Menu Option	Menu Items	Set Points	Installer Settings	Page
		Data Stream	Serial Data Stream		79
			Serial Baud Rate		
			Network Data Stream		
			Destination IP		
			Destination Port		
		System Name	System Name		79
			Status Title		
		Installer Information	Company		80
			Name		
			Phone		
			Notes		
		Installer Settings	Set User Access Level		80
			Change Installer Password		
			Challenge Installer Password		

Table 8 Installer Settings (Inverter Settings)

Menu	Menu Option	Menu Items	Set Points	Installer Settings	Page
System	Inverter	Search	Sensitivity		82
			Pulse Length		
			Pulse Spacing		
		AC Voltage and Current Limit	Input Type (grid or gen) (FX-class only)		83
			Input Priority (grid or gen) (Radian-class only)		
			Grid Input AC Limit		
			Gen Input AC Limit		
			Charger AC Limit		
		Grid AC Voltage Limits (FX-class only)	Lower Voltage Limit		85
			Upper Voltage Limit		
			Transfer Delay		
		Gen AC Voltage Limits (FX-class only)	Lower Voltage Limit		85
			Upper Voltage Limit		
			Transfer Delay		
			Connect Delay		
		Grid AC Mode and Limits (Radian-class only)	Input Mode		86
			Voltage Limit Lower		
			(Voltage Limit) Upper		
			Transfer Delay		
			Connect Delay		
		Gen AC Mode and Limits (Radian-class only)	Input Mode		87
			Voltage Limit Lower		
			(Voltage Limit) Upper		
			Transfer Delay		
			Connect Delay		
		AC Output	Output Voltage		88

Specifications

Table 8 Installer Settings (Inverter Settings)

Menu	Menu Option	Menu Items	Set Points	Installer Settings	Page
		Low Battery	Cut-Out Voltage		88
			Cut-In Voltage		
		Battery Charger	Absorb Voltage		89
			(Absorb) Time		
			Float Voltage		
			(Float) Time		
		Battery Equalize	Re-Float Voltage		89
			Equalize Voltage		
		Auxiliary Output (FX-class only)	(Equalize) Time		90
			Status		
		Auxiliary Output (Radian-class only)	AUX Mode (Remote, Load Shed, Gen Alert, Fault, Vent Fan, Cool Fan, Divert DC, Diver AC, AC Drop)		93
			Status		
		Auxiliary Relay (Radian-class only)	AUX Mode (Load Shed, Gen Alert, Fault, Vent Fan, Cool Fan, DC Divert, IEEE, Source Status, AC Divert)		96
			Status		
		Inverter Stacking	Stack Mode		99
Master Power Save Level					
Slave Power Save Level					
Grid-Tie Sell	Grid-Tie Enable		101		
	Sell Voltage				
	Grid-Tie Window				
Calibrate	Input Voltage		102		
	Output Voltage				
	Battery Voltage				
Reset to Factory Defaults	No or Yes		103		

Table 9 Installer Settings (Charge Controller Settings)

Menu	Menu Option	Menu Items	Set Points	Installer Settings	Page
System	Charge Controller	Charger	Absorb Voltage		104
			(Absorb) Time		
			Float Voltage		
			Rebulk Voltage		
			Current Limit		
			Absorb End Amps		
		MPPT	MPPT Mode		105
			U-Pick VOC		
			Wakeup VOC Change VDC		
			Wakeup VOC Change Time		
			Snooze Mode Amps		
			MPPT Range Minimum		
			MPPT Range Maximum		
		Temperature Compensation	Mode (Wide/Limited)		106
			Limited: Lower Battery Voltage		
			Limited: Upper Battery Voltage		
		Battery Equalize	Equalization Voltage		106
			Hours		
			Automatic Battery Equalization		
		Grid Tie Mode	Y or N		107
Auxiliary Output	Status		107		
	AUX Mode				
	Vent Fan				
	PV Trigger				
	Error Output				
	Night Light				
	Float				
	Diversion: Relay				
	Diversion: Solid St				
Low Batt Disconnect Remote					
Restart Mode	0, 1, 2		110		
Calibrate	Battery Voltage		110		
Reset to Factory Defaults	Y or N		111		

Specifications

Table 10 Installer Settings (Battery Monitor Settings)

Menu	Menu Option	Menu Items	Set Points	Installer Settings	Page
System	Battery Monitor	Battery Setup	Battery Amp-hours		112
			Charge Voltage		
			Time		
			Minutes		
			Charged Return Amps		
			Charge Factor ____%		
		Shunt Enable	Shunt A (Enable/Disable)		112
			Shunt B (Enable/Disable)		
			Shunt C (Enable/Disable)		
		FLEXnet Relay Mode	Status (ON or OFF) Invert Logic (?)		113
		FLEXnet Relay Set Points	Voltage: High ____Vdc		113
			Voltage: Low ____Vdc		
			SOC: High ____%		
			SOC: Low ____%		
			Delay: High _____ Low: _____Minutes		
		Reset to Factory Defaults	Y or N		114

Table 11 Installer Settings (MATE3 Settings)

Menu	Menu Option	Menu Items	Set Points	Installer Settings	Page
System	MATE3	AGS	Setup	AGS Enabled	116
				Port	
				Fault Time	
				Warmup Time	
				Cool Down Time	
				DC Gen Set	
				Voltage Stop	
			Voltage Start	24 Hour Start Enable	118
				2 Hour Start Enable	
				2 Minute Start Enable	
			Load Start	Enabled	118
				Start	
				Stop	
			State-of-Charge Start	Enabled	118
				Start SOC ____%	
				Stop SOC ____%	
				Enable Full Change (Y/N)	
			Must Run Schedule	Enable	119
				Weekday Start	
				Weekday Stop	
Weekend Start					
Weekend Stop					

Table 11 Installer Settings (MATE3 Settings)

Menu	Menu Option	Menu Items	Set Points	Installer Settings	Page
		Quiet Time Schedule	Enable		119
			Weekday Start		
			Weekday Stop		
			Weekend Start		
			Weekend Stop		
		Generator Exercise Schedule	Enable		120
			Exercise Run on (Day)		
			Start Time (0:00)		
			Run Period (15 minutes)		
			Exercise Interval (2 weeks)		
		Disable Sell During Exercise (N/Y)			
		Set Generator Total Run Time	0.0 – 999.9 Hours		121
		Display AGS Timers			121
		Data Logging			122
		High Battery Transfer	Enable (Disabled)		124
			Grid Connect ___ Vdc		
			Delay ___ min (Range?)		
			Grid Disconnect ___ VDC		
			Delay ___ min (Range?)		
			Grid Connect SOC ___%		
		Grid Disconnect SOC ___%			
		Grid Use Time	Enable (Y or N)		125
			Weekday Use		
			Weekday Drop		
			Enable (Y or N)		
			Weekday Use		
			Weekday Drop		
			Enable (Y or N)		
			Weekday Use		
			Weekday Drop		
			Enable (Y or N)		
			Weekend Use		
		Weekend Drop			
		Charge Controller Float Coordination	Enable (Y or N)		127
		FLEXnet DC Advanced Control	Enable Charge Termination Control		128
			Enable Auto Grid-Tie Control		
			Battery Status		
			Low SOC Warning Level		
			Critical SOC Warning Level		
		Reset to Factory Defaults	Y or N		129

Table 12 Installer Settings (Configuration Wizard)

Menu	Menu Option	Menu Items	Set Points	Installer Settings	Page
Configuration Wizard	New Configuration	System Type	System Type: (Off Grid, Grid Tied, Backup)		130
			System Voltage: (12, 24, 36, 48, and 60 Vdc)		
			Array Wattage: (0 to 50 kW)		
			Battery Type: (FLA, AGS, GEL)		
		Battery Charging	Absorb Voltage:		
			Time:		
			Float Voltage:		
			Time:		
			Equalize Voltage:		
			Time:		
		AC Configuration	AC Output Voltage (Vac)		
			AC Phase		
			AC Input Breaker Size (amps)		
			Maximum Output Load (amps)		
		Generator Configuration	Generator Installed: (Y or N)		
			Generator Type: (AC, DC, or None)		
			Size (kW):		
			Generator Start: Manual, Auto, Off		
			AUX Output Device Port:		
	Existing Configuration	Program	Displays a list of pre-saved configurations that can be programmed into the system.		132
		Continue	See New Configuration above.		
	Restore Configuration		Displays a list of pre-saved configurations that can be programmed into the system.		135



Menu Maps

These menu maps show the progression through each of the software menus that are available for the MATE3. Some features may not be available depending on the type of inverter that is installed in the system.

See Figure 61 for navigation controls and Figure 62 for instructions on using the control wheel to navigate through the menu maps.

Menu maps in this section include the following:

Menu	See Page....
Main Menu Overview	162
Settings:	163 through 168
➤ System	163
➤ Inverter	164
➤ Charge Controller	166
➤ FLEXnet DC Battery Monitor	167
➤ MATE3	168
Configuration Wizard	169 thru 171
Device Data Logs	173
Event Logs	175

Main Menu

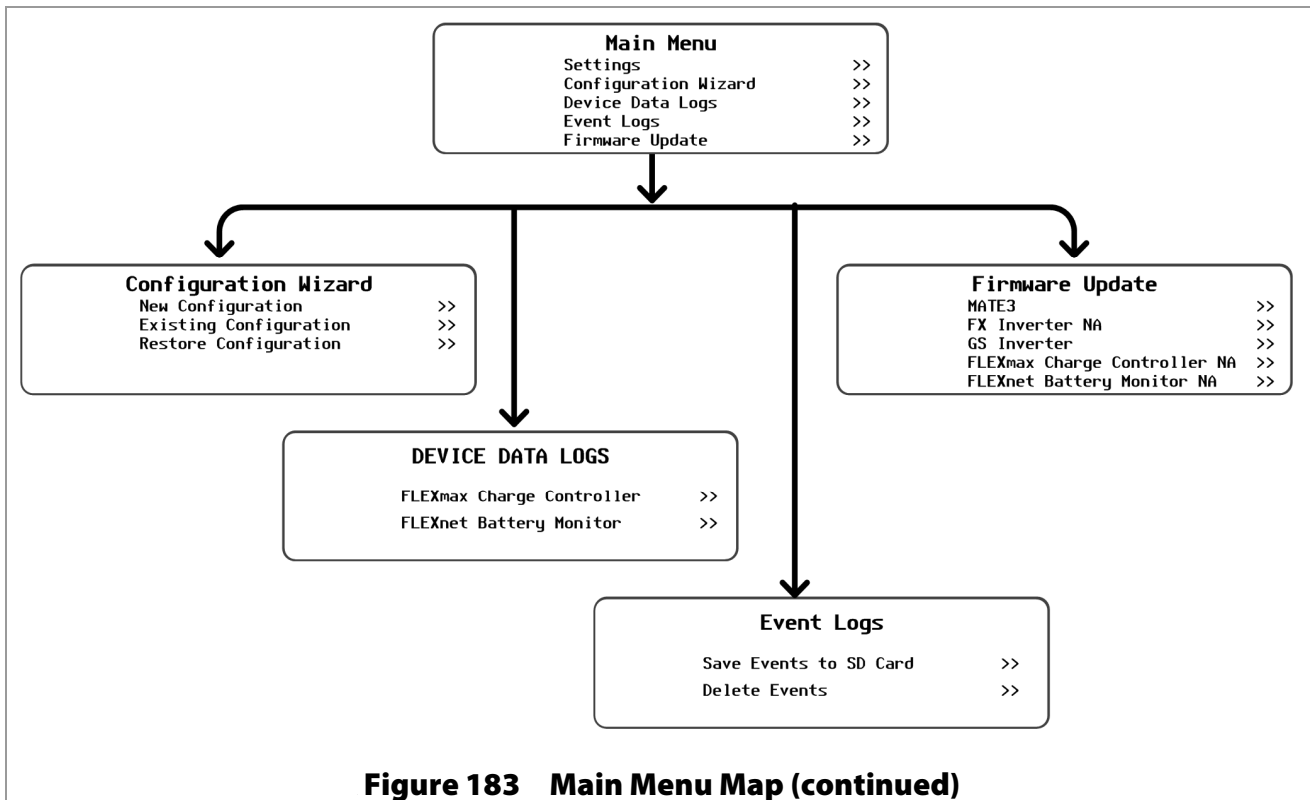
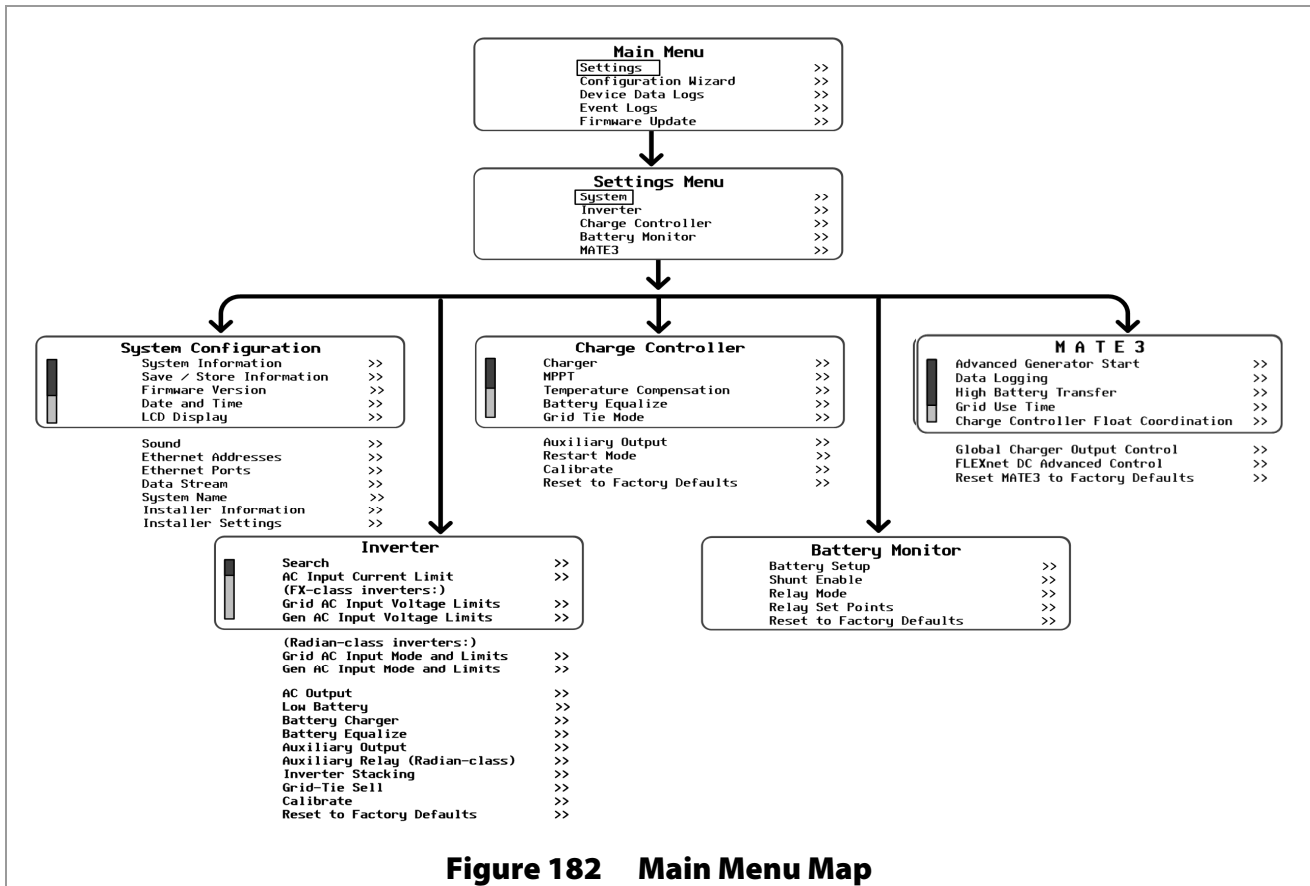

SETTINGS: System Menu Map (with User Access Levels)

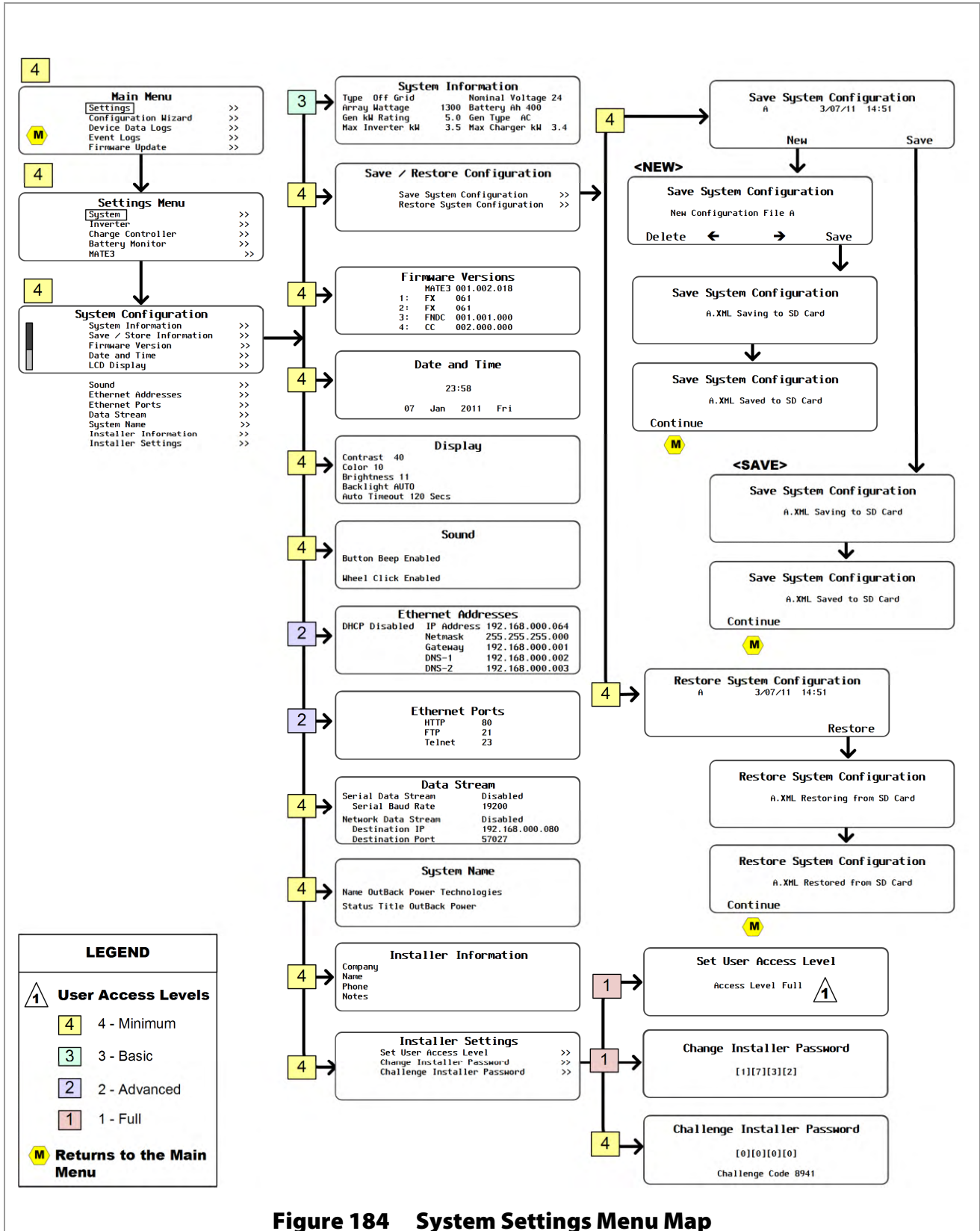

Figure 184 System Settings Menu Map

SETTINGS: FX-class Inverter Menu Map (with User Access Levels)

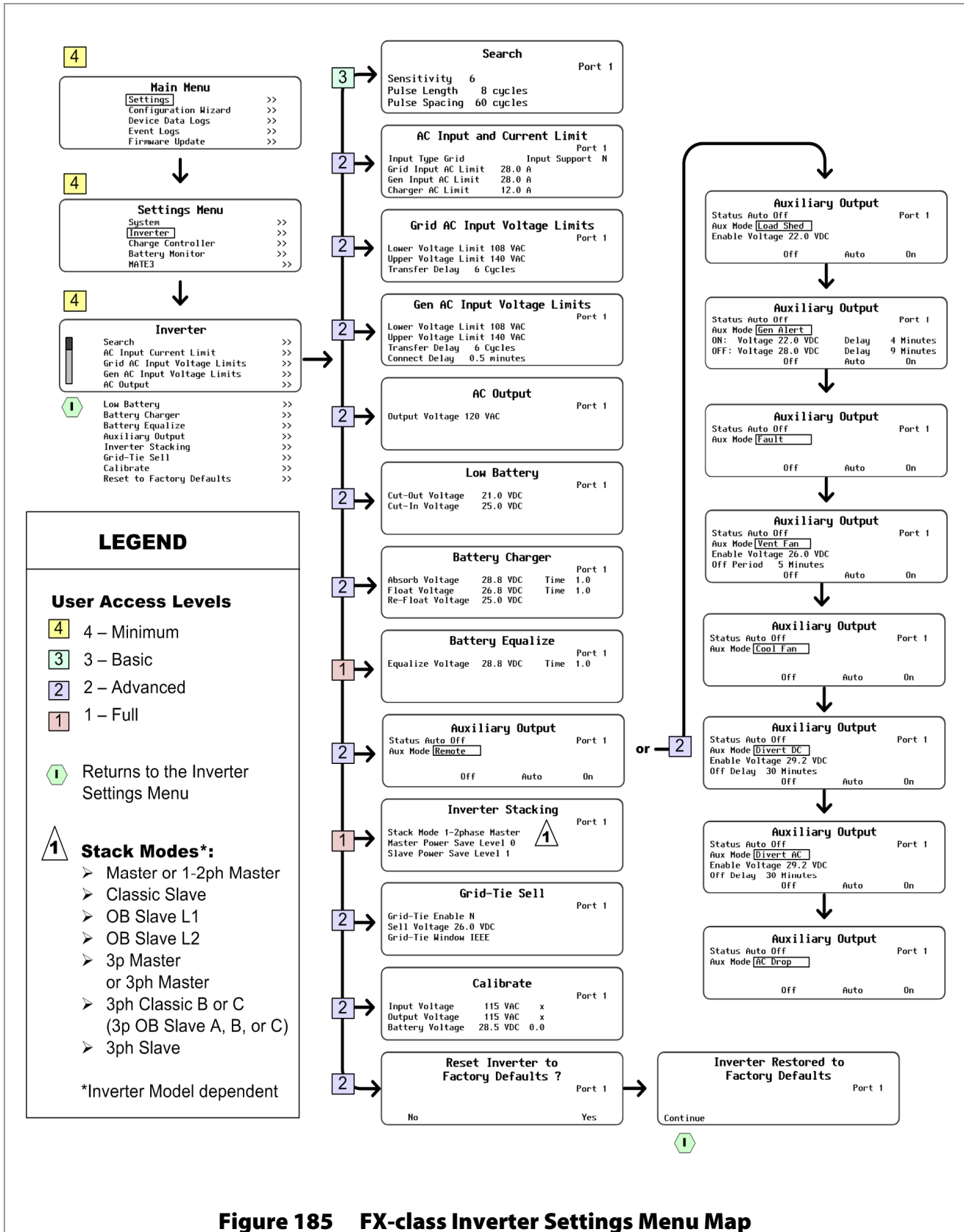

Figure 185 FX-class Inverter Settings Menu Map

SETTINGS: Radian-class Inverter Menu Map (with User Access Levels)

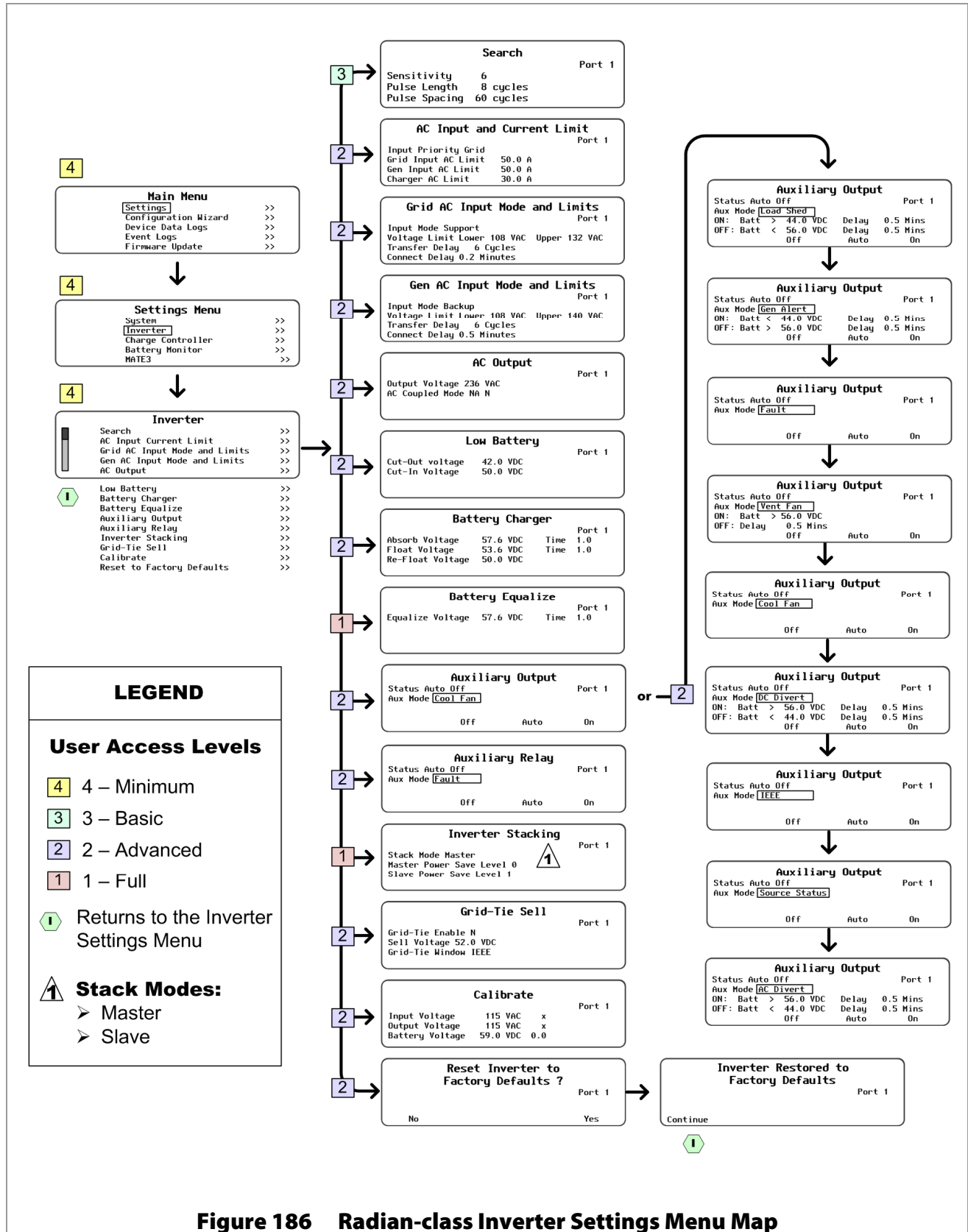

Figure 186 Radian-class Inverter Settings Menu Map

SETTINGS: Charge Controller Menu Map (with User Access Levels)

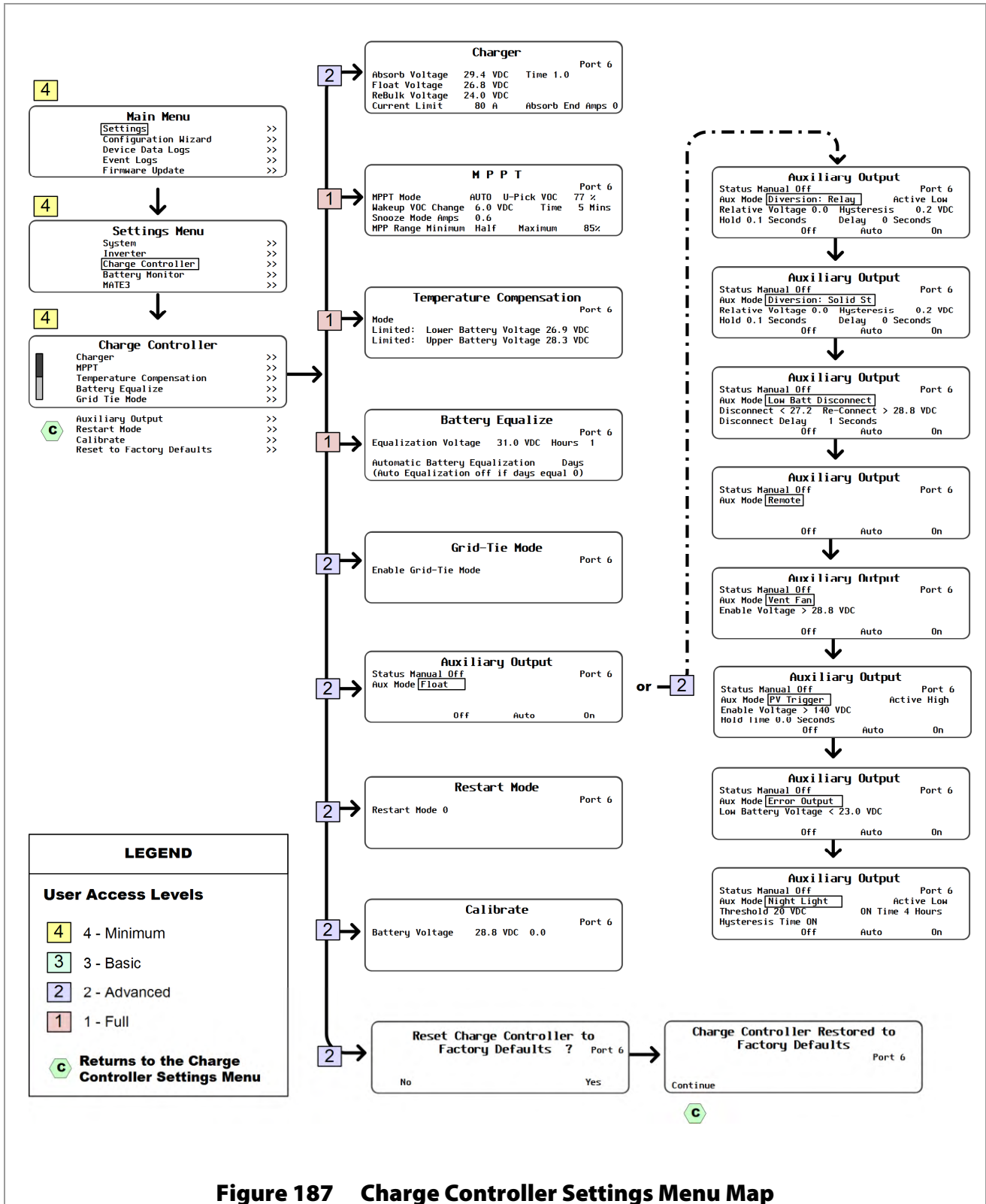

Figure 187 Charge Controller Settings Menu Map

SETTINGS: FLEXnet DC Menu Map (with User Access Levels)

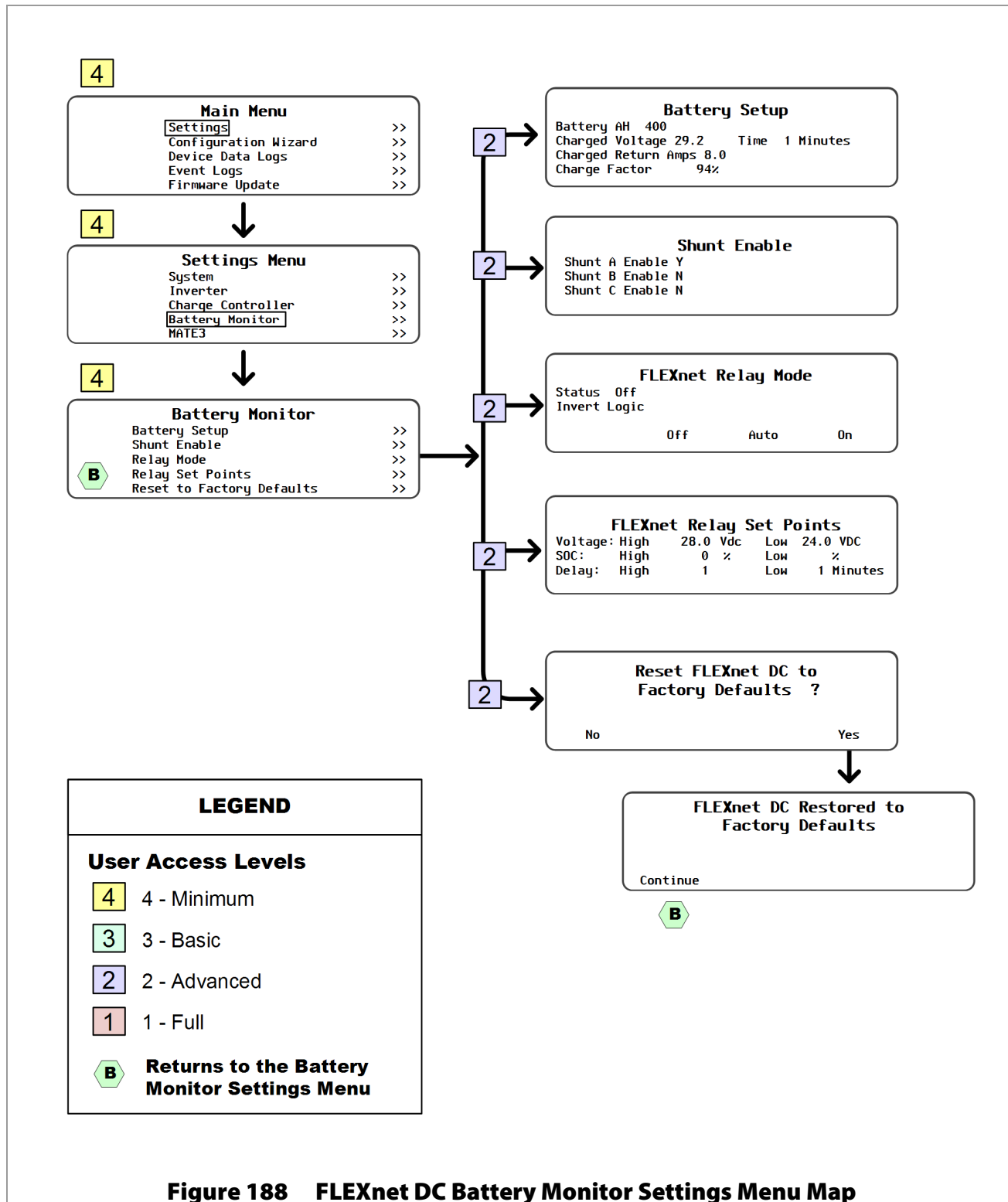

Figure 188 FLEXnet DC Battery Monitor Settings Menu Map

SETTINGS: MATE3 Menu Map (with User Access Levels)

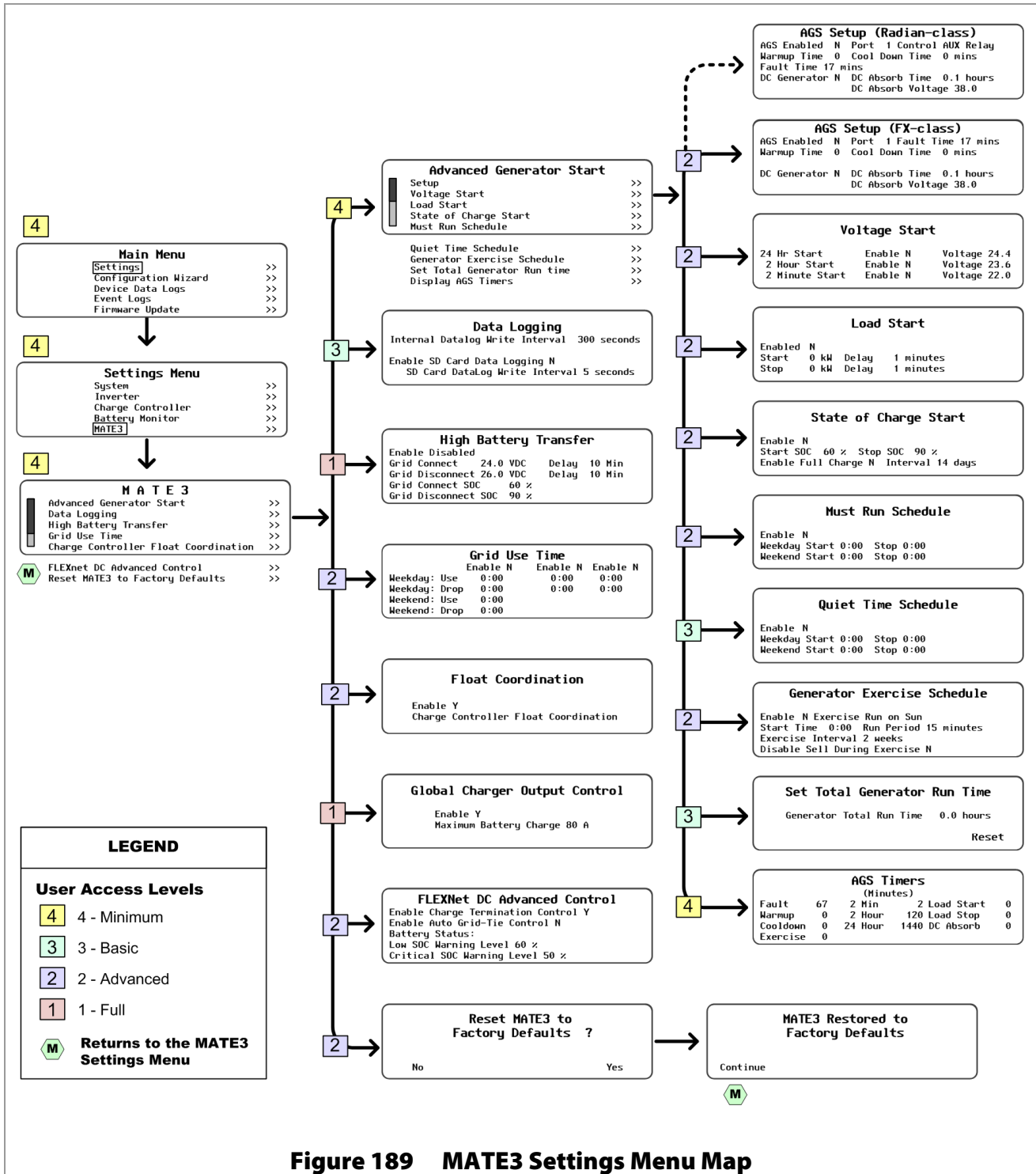
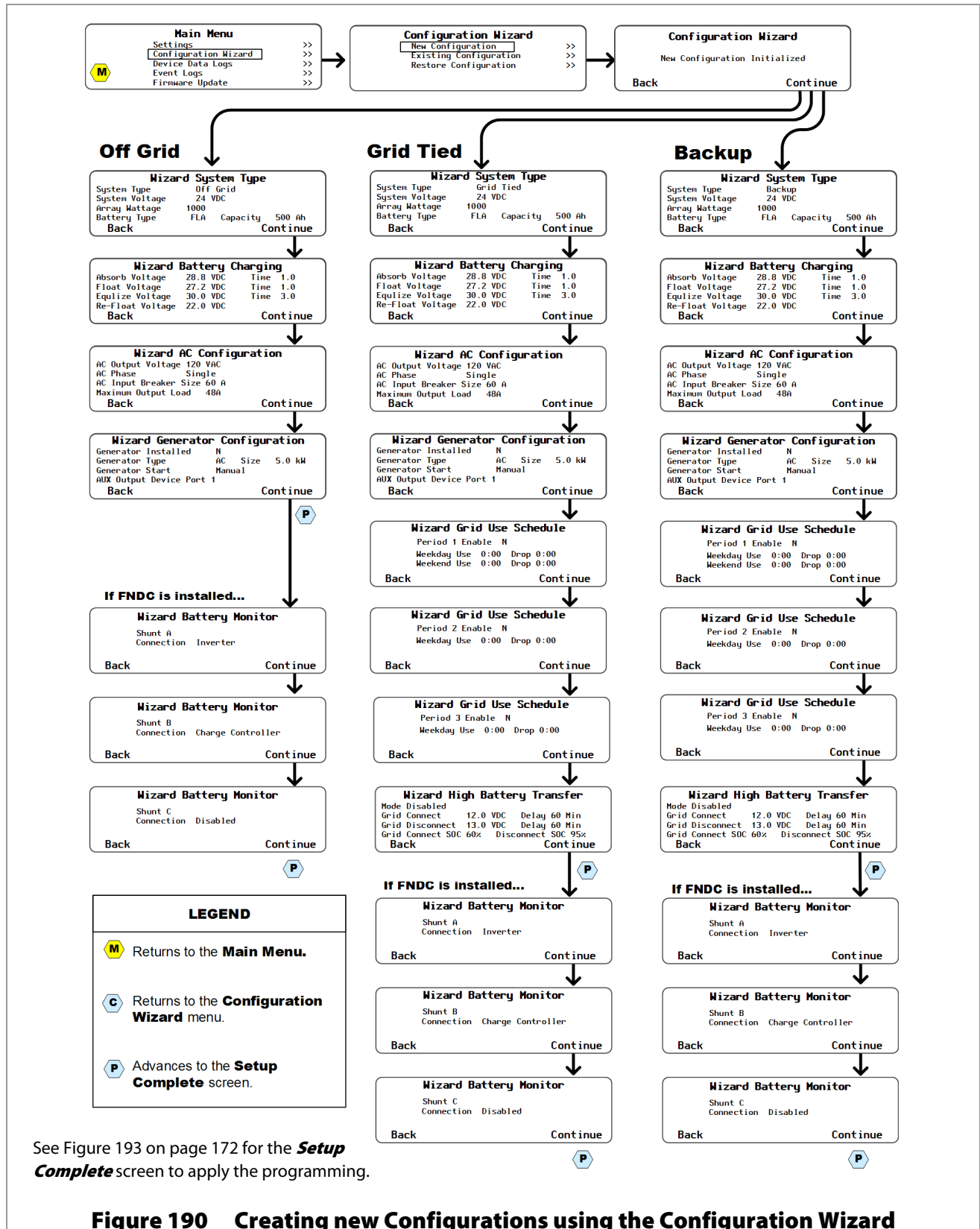

Figure 189 MATE3 Settings Menu Map

Configuration Wizard

New Configurations



See Figure 193 on page 172 for the **Setup Complete** screen to apply the programming.

Figure 190 Creating new Configurations using the Configuration Wizard

Existing Configurations

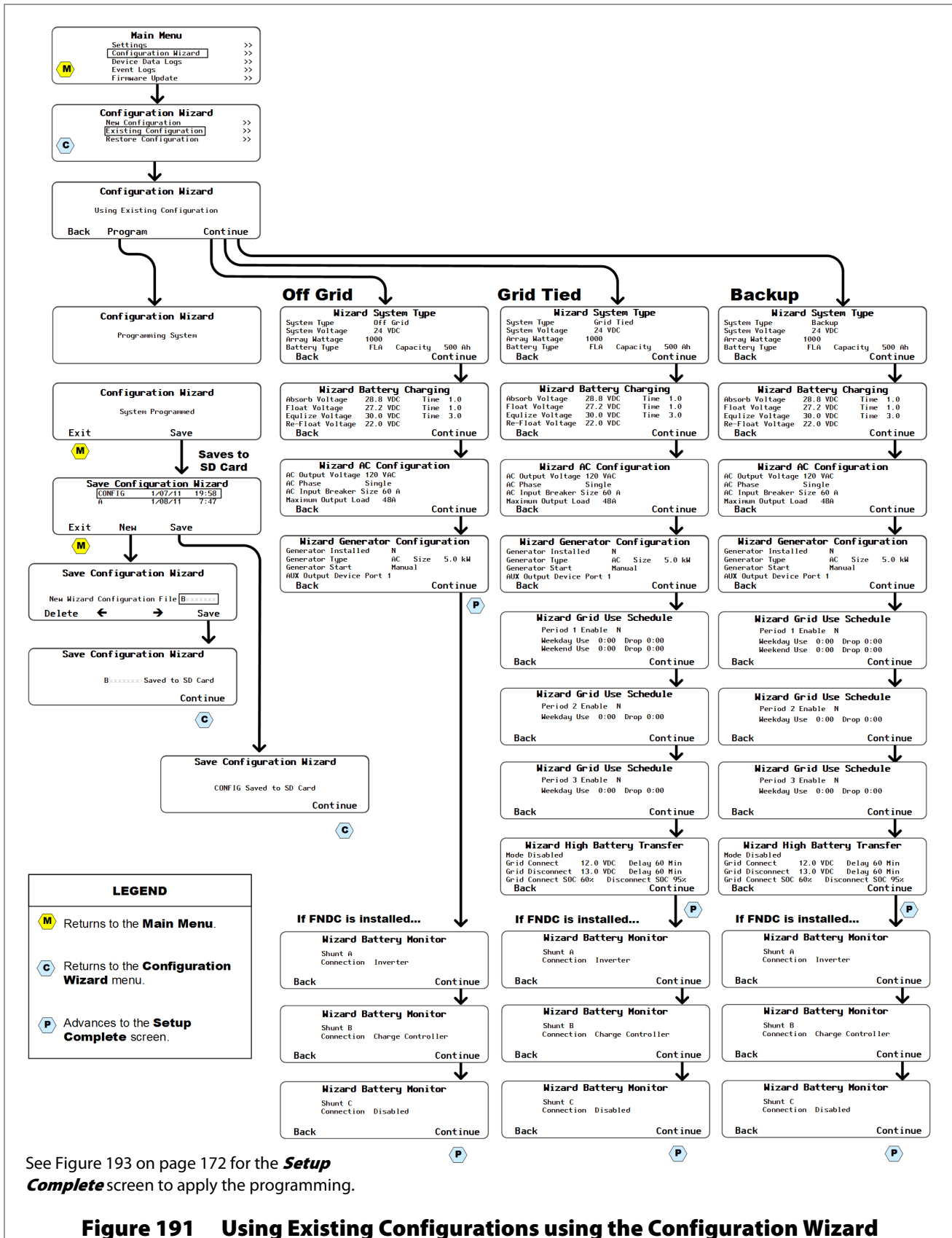

Restoring Configurations

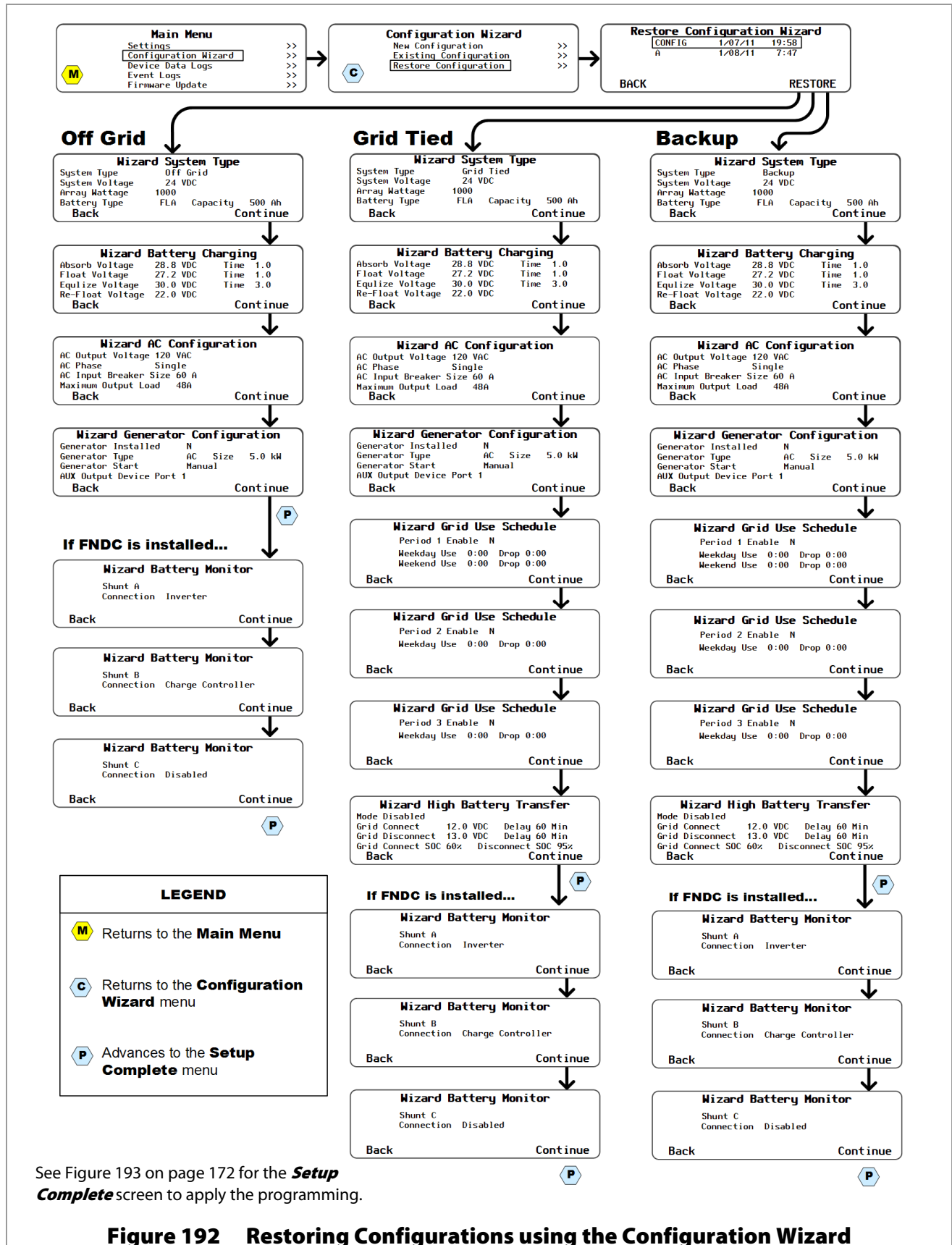

Setup Complete Screen

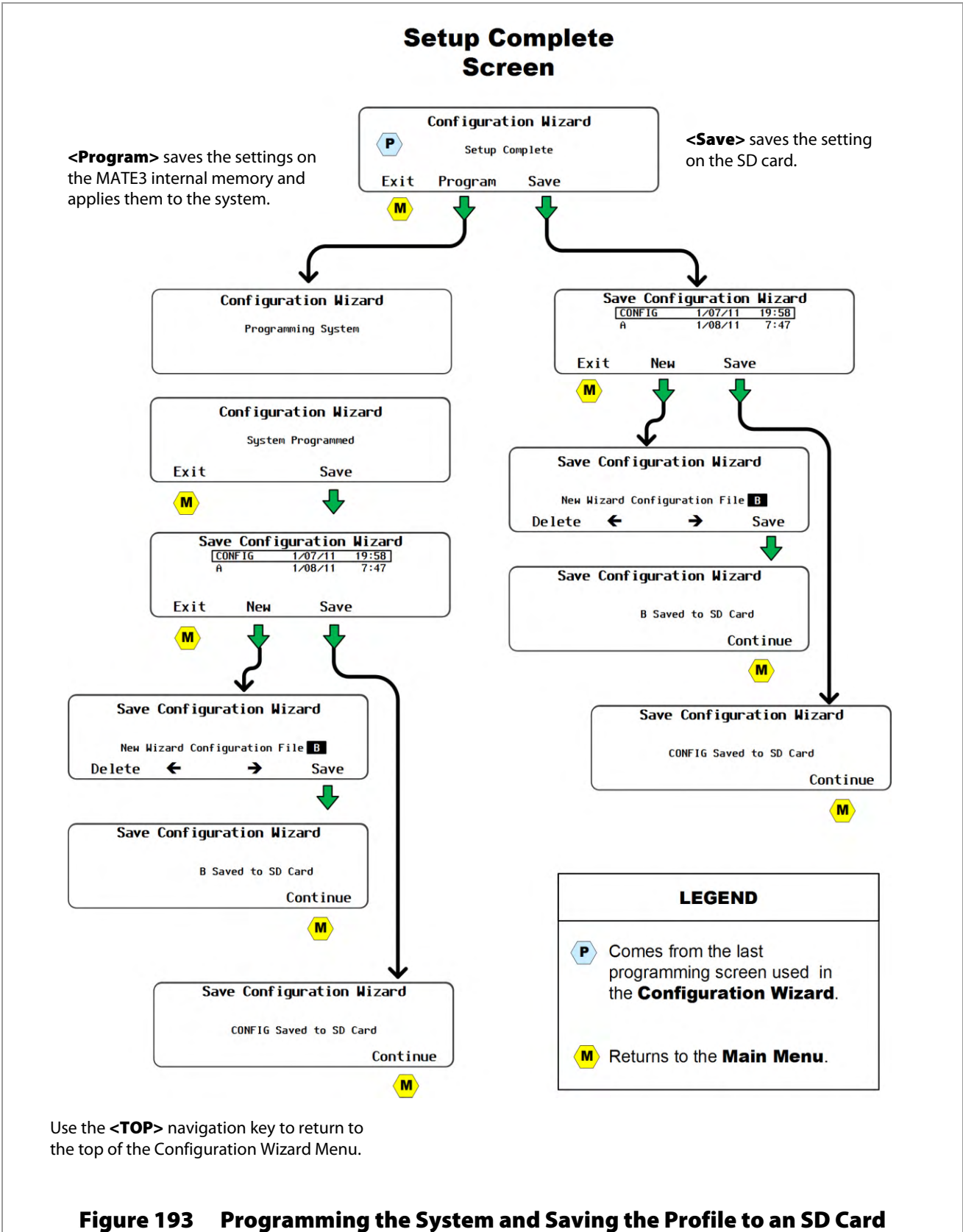

Figure 193 Programming the System and Saving the Profile to an SD Card

Device Data Logs

FLEXmax Charge Controller Data Logs

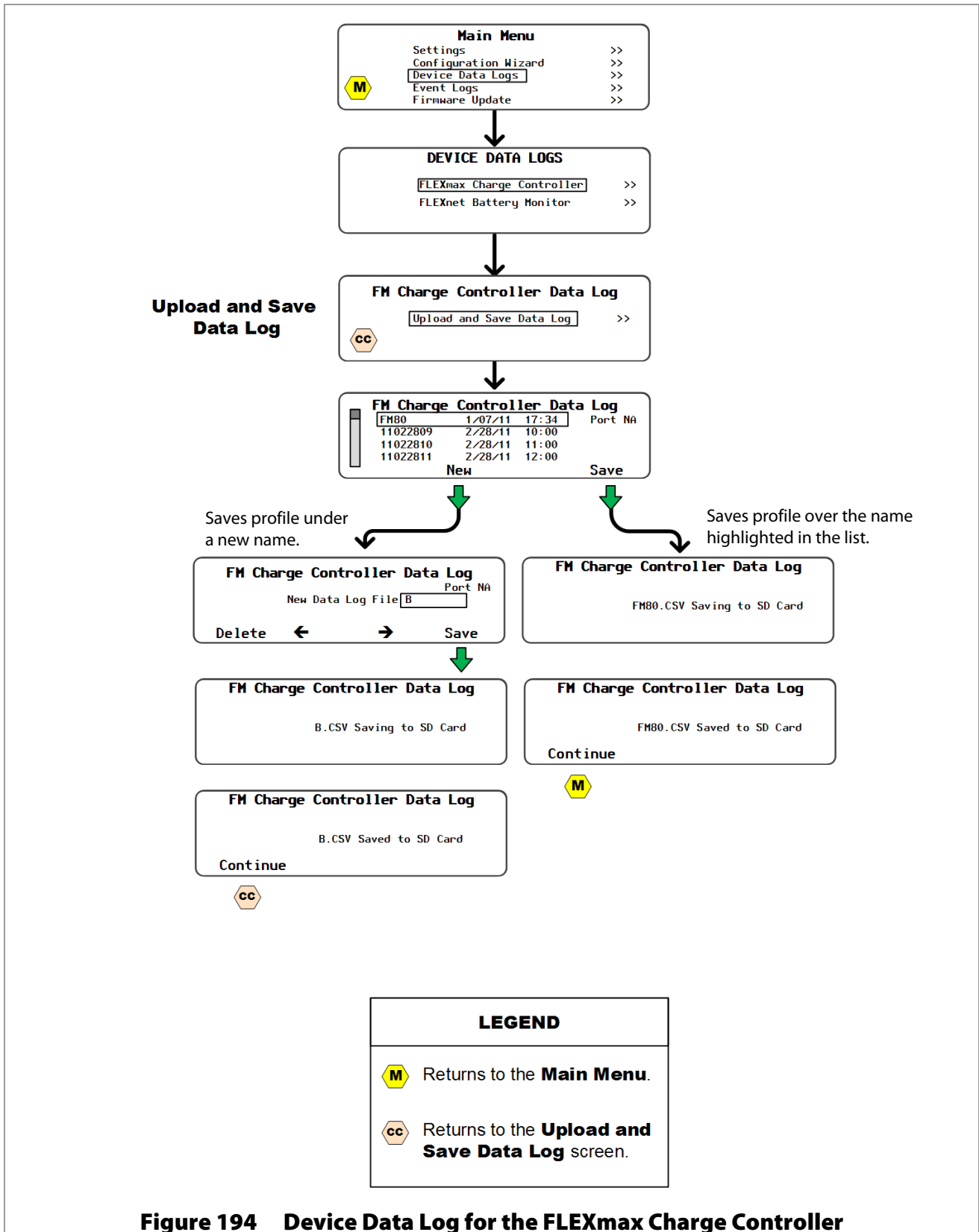

Figure 194 Device Data Log for the FLEXmax Charge Controller

FLEXnet DC Battery Monitor Data Logs

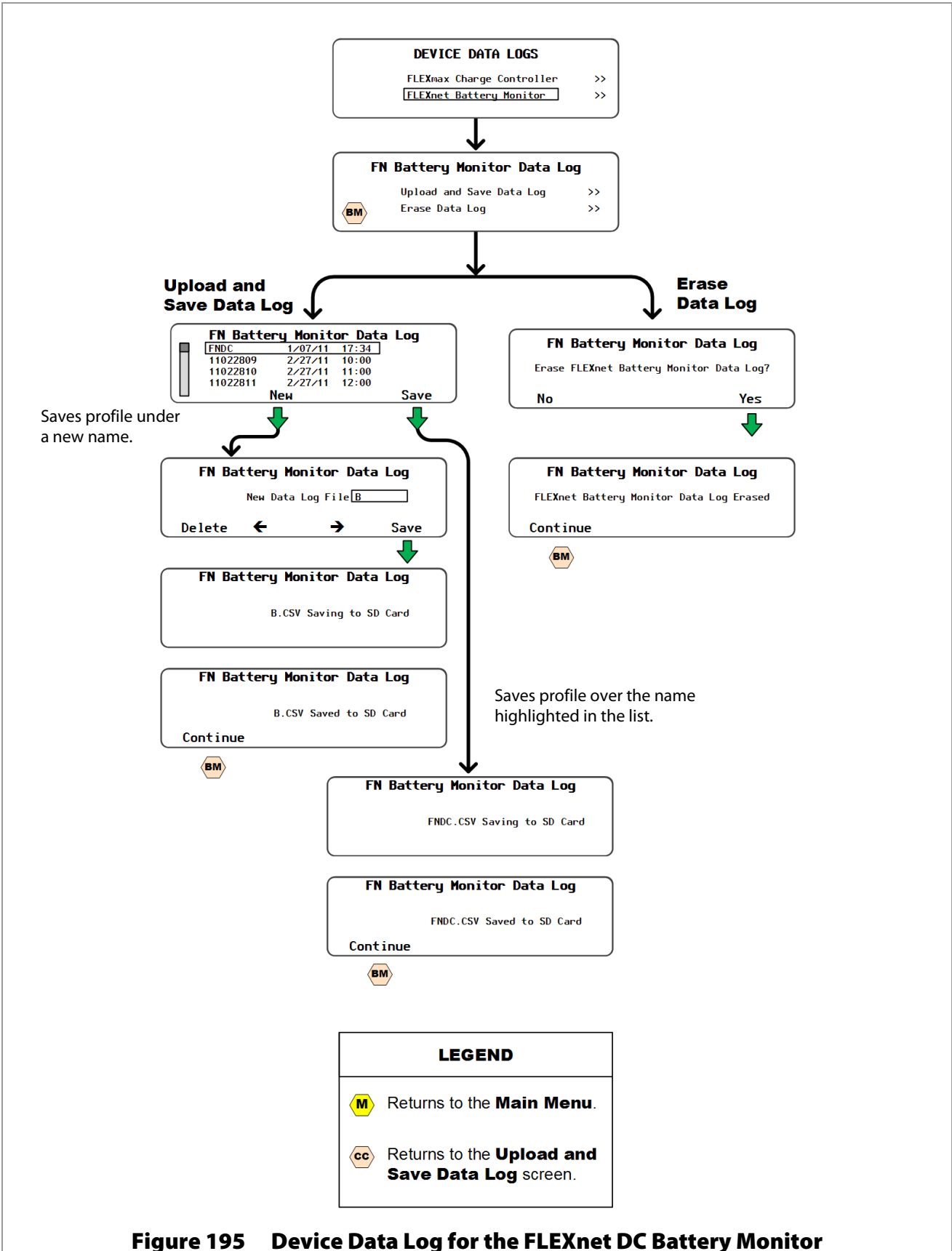

Figure 195 Device Data Log for the FLEXnet DC Battery Monitor

Event Logs

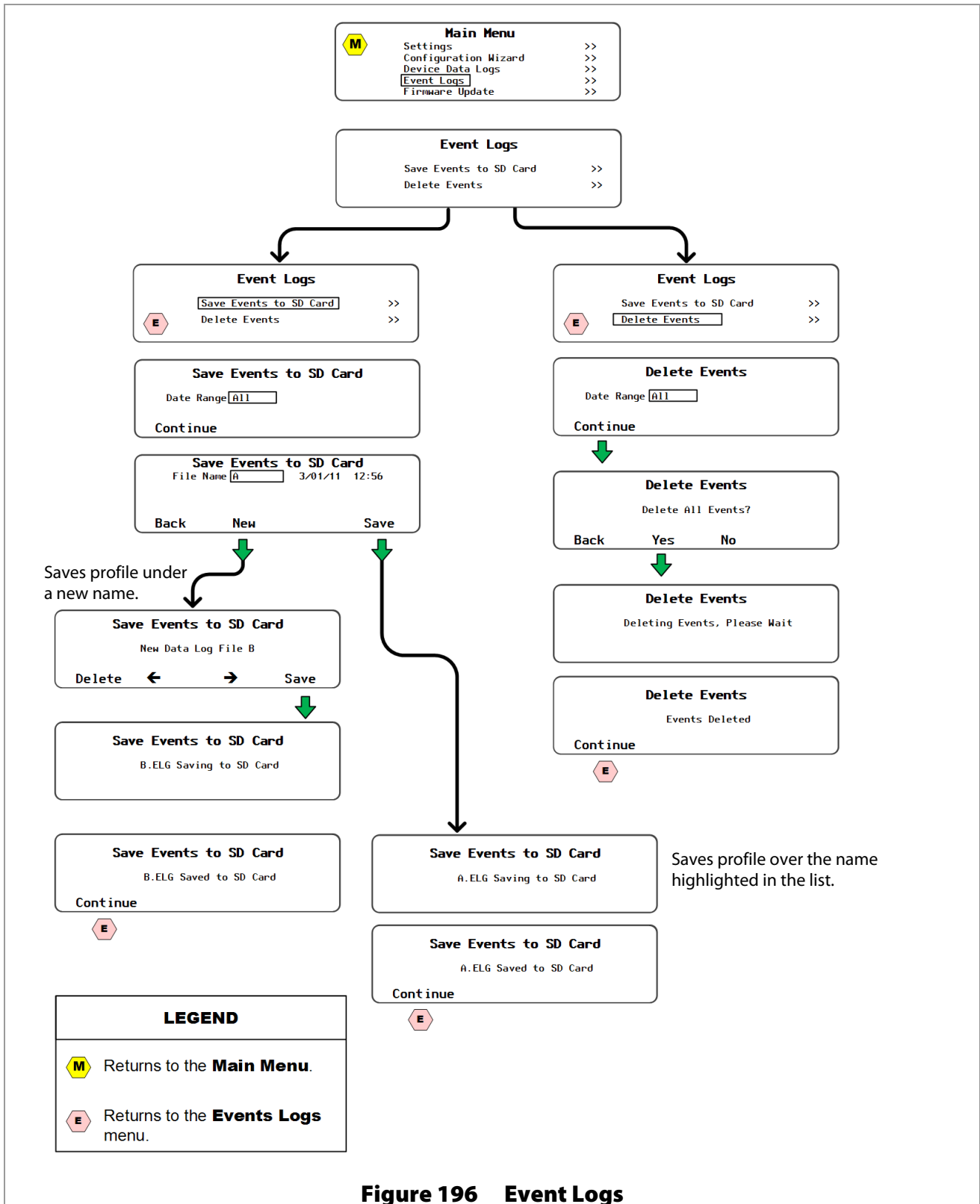

Figure 196 Event Logs



Product Registration

The purchase of an OutBack Power Technologies product is an important investment. Registering the products will help us maintain the standard of excellence expected in terms of performance, quality and reliability.

Please take a moment to register and provide us with some important information.

Registration can be done as follows:

- Go to the following website.
<http://www.outbackpower.com/resources/warranty/>
or

Fill out the information on this form (pages 177 and 178) and return a paper copy using a postal service to the following address:

OutBack Power Technologies

Attn: Warranty Registration
5917 – 195th Street N.E., #7
Arlington, WA 98223 USA

Be sure to keep a copy for your records.

SYSTEM OWNER	
Name	
Address	
City, State, Postal Code or Zip Code	
Country	
Telephone Number	
E-mail	
SYSTEM PURCHASE	
Product Model Number	
Product Serial Number	
Sold by	
Purchase Date	

Product Registration

INSTALLATION INFORMATION	
System Install/Commission Date	
System Array Size	
System Array Nominal Voltage	
Type of PV Modules	
System Battery Bank Size (Amp-Hours)	
Brand and Model of Batteries	
Does this system include an auxiliary AC generator?	
If yes, please specify brand and model of generator	
INSTALLER INFORMATION	
Contractor Number	
Installer Name	
Installer Address	
Installer City, State, Postal or Zip Code, Country	
Installer Telephone/E-mail	

Please check ALL factors affecting purchase decision:

- Grid-Interactive Capability
- Product Reputation
- Back-up Capability
- Reputation of OutBack Power Technologies
- Value
- Outdoor Installation Option
- Looks
- Other



Warranty

5-Year Limited Warranty for the MATE3 System Display and Controller

OutBack Power Technologies, Inc. (“OutBack”) provides a five-year (5) limited warranty (“Warranty”) against defects in materials and workmanship for its MATE3 Display and Controller (“Product”).

The term of this Warranty begins on the Product(s) initial purchase date, or the date of receipt of the Product(s) by the end user, whichever is later. This must be indicated on the invoice, bill of sale, and/or warranty registration submitted to OutBack. This Warranty applies to the original OutBack Product purchaser, and is transferable only if the Product remains installed in the original use location. The warranty does not apply to any Product or Product part that has been modified or damaged by the following:

- Installation or removal;
- Alteration or disassembly;
- Normal wear and tear;
- Accident or abuse;
- Corrosion;
- Lightning;
- Repair or service provided by an unauthorized repair facility;
- Operation or installation contrary to manufacturer product instructions;
- Fire, floods or acts of God;
- Shipping or transportation;
- Incidental or consequential damage caused by other components of the power system;
- Any product whose serial number has been altered, defaced or removed;
- Any other event not foreseeable by OutBack.

OutBack’s liability for any defective Product, or any Product part, shall be limited to the repair or replacement of the Product, at OutBack’s discretion. OutBack does not warrant or guarantee workmanship performed by any person or firm installing its Products. This Warranty does not cover the costs of installation, removal, shipping (except as described below), or reinstallation of Products or parts of Products.

THIS LIMITED WARRANTY IS THE EXCLUSIVE WARRANTY APPLICABLE TO OUTBACK PRODUCTS. OUTBACK EXPRESSLY DISCLAIMS ANY OTHER EXPRESS OR IMPLIED WARRANTIES OF ITS PRODUCTS, INCLUDING BUT NOT LIMITED TO ANY IMPLIED WARRANTIES OF MERCHANTABILITY OR FITNESS FOR A PARTICULAR PURPOSE. OUTBACK ALSO EXPRESSLY LIMITS ITS LIABILITY IN THE EVENT OF A PRODUCT DEFECT TO REPAIR OR REPLACEMENT IN ACCORDANCE WITH THE TERMS OF THIS LIMITED WARRANTY AND EXCLUDES ALL LIABILITY FOR INCIDENTAL OR CONSEQUENTIAL DAMAGES, INCLUDING WITHOUT LIMITATION ANY LIABILITY FOR PRODUCTS NOT BEING AVAILABLE FOR USE OR LOST REVENUES OR PROFITS, EVEN IF IT IS MADE AWARE OF SUCH POTENTIAL DAMAGES. IF YOU ARE A CONSUMER THAT PURCHASED THIS PRODUCT IN A MEMBER STATE OF THE EUROPEAN UNION, YOU MAY HAVE ADDITIONAL STATUTORY RIGHTS UNDER DIRECTIVE 1999/44/EC. THESE RIGHTS MAY VARY FROM EU MEMBER STATE TO EU MEMBER STATE. SOME STATES (OR JURISDICTIONS) MAY NOT ALLOW THE EXCLUSION OR LIMITATION OF WARRANTIES OR DAMAGES, SO THE ABOVE EXCLUSIONS OR LIMITATIONS MAY NOT APPLY TO YOU.

How to Arrange for Warranty Service

During the warranty period beginning on the invoice date, OutBack Power Technologies will repair or replace products covered under this limited warranty that are returned to OutBack Power Technologies' facility or to an OutBack Power Technologies authorized repair facility, or that are repaired on site by an OutBack Power Technologies authorized repair person.

**IMPORTANT:**

For full Warranty description, see previous page.

Contacting OutBack

To request warranty service:

- call OutBack Technical Support at **+1.360.435.6030**, or direct at **+1.360.618.4363**, or
- send an email to Technical Support at **support@outbackpower.com**.

To ensure warranty coverage, this contact must be within the effective warranty period. If service is required, the OutBack Technical Support representative will issue a Return Material Authorization (RMA) number.

Troubleshooting

In the event of a Product failure, the customer will need to work with an OutBack Technical Support representative to perform the necessary troubleshooting. This is a required step before a return can be performed. Troubleshooting requires a qualified technician to be present at the site of the Product, with a quality voltmeter that measures both DC and AC. The OutBack representative will request voltmeter readings, Product error messages, and other information. Many, many problems can be resolved on-site. If the customer is not willing or able to provide these readings (or is not willing or able to visit the site), and the Product is found to have no problems upon return, OutBack may choose to charge additional labor and handling fees up to \$180.00 U.S.

Return Material Authorization (RMA)

A request for an RMA number requires all of the following information:

1. Product model and serial number;
2. Proof-of-purchase in the form of a copy of the original Product purchase invoice or receipt confirming the Product model number and serial number;
3. Description of the problem; and
4. Shipping address for the repaired or replacement equipment.

Upon receiving this information, the OutBack representative can issue an RMA number.

Returning Product to OutBack

After receiving the RMA number, the customer must pack the Product(s) authorized for return, along with a copy of the original purchase invoice and warranty certificate, *in the original Product shipping container(s) or packaging providing equivalent or reasonable protection*. The RMA number must be written on the outside of the packaging where it is clearly visible.

If Product is within the warranty period, OutBack will cover prepaid shipping with prior arrangement.

The Product(s) must be shipped back to OutBack Power Technologies in their original or equivalent packaging, to the following address:

OutBack Power Technologies

RMA # _____
6115 192nd Street NE
Arlington, WA 98223 USA

The customer must insure the shipment, or accept the risk of loss or damage during shipment. If a shipping box is needed for return of a Product, OutBack will send a shipping box upon request.



IMPORTANT:

OutBack is not responsible for shipping damage caused by improperly packaged Products, the repairs this damage might require, or the costs of these repairs.

If, upon receipt of the Product, OutBack determines the Product or Product part is defective and that the defect is covered under the terms of this Warranty, OutBack will then, and only then, ship a repaired or replacement Product or Product part to the purchaser freight prepaid, non-expedited, using a carrier of OutBack's choice, where applicable.

If Product fails in ninety (90) or fewer days from original purchase date, OutBack will replace with a new Product. If Product fails after ninety (90) days and up to expiration of warranty, OutBack will, at its discretion, either repair and return a Product, or ship a replacement Product. OutBack will determine whether a Product is to be repaired or replaced in accordance with Product age and model. OutBack will authorize advance shipment of a replacement based on Product age and model.

In cases where an OutBack dealer or distributor replaces a Product more than ninety (90) days old with a new Product, OutBack will NOT compensate that dealer or distributor with new stock unless the exchange was authorized in advance by OutBack.

Out of Warranty

If Product is out of warranty, OutBack will repair and return Product for a fee. Alternately, if applicable, upon request, OutBack will advance-ship replacement parts for a fee.

If a shipping box is needed for return of out-of-warranty Product, OutBack will send a shipping box upon request. The customer is responsible for paying shipping to OutBack.

The warranty period of any repaired or replacement Product or Product part is ninety (90) days from the date of shipment from OutBack, or the remainder of the initial warranty term, whichever is greater.

This Warranty is void for any Product that has been modified by the customer without authorization by OutBack. A Product with a voided warranty will be treated the same as one with an expired warranty.



Index

A

AC Drop	95, 98
AC Drop (Aux Mode - INV)	92
AC Input Current Limit.....	83
AC Output (INV).....	88
AC Voltage	34–36
Calibration.....	102
Generator	60, 85, 87
Grid Status.....	39
Inverter	40, 55
Output	88
Warnings.....	42
Additional Resources	4
Adjusting Set Points	68
Advanced Generator Start (AGS) Mode	115
AGS Functional Test.....	117
AGS Setup.....	116
Display AGS Timers	121
Generator Exercise Schedule	120
Load Start	118
Must Run Schedule	119
Quiet Time Schedule	119
SOC Start.....	119
Voltage Start.....	118
AGS Fault.....	See Generator Fault
AGS Start and Stop Reasons	152
Amp-hour measurements	47–50, 52, 53
Amp-hour sizing	74, 112
Audience	1
AUX Functions	
AC Drop.....	95, 98
Aux Mode (CC).....	107, 108
Diversion Relay	109
Diversion Solid St.....	109
Error Output	108
Float.....	109
Low Batt Disconnect.....	110
Night Light	109
PV Trigger	108
Remote	110
Vent Fan	108
Aux Mode (Inverter)	
AC Drop.....	92
Cool Fan	91, 94, 97
Divert DC	91, 94, 97
Fault.....	91, 94, 97
Gen Alert.....	91, 94, 97

Load Shed	90
Remote.....	90
Vent Fan.....	91, 94, 97
Auxiliary Output (CC)	107, 115
Auxiliary Output (Inverter)	90, 93, 96

B

Backup	33
Backup (System Type).....	36
Basic Navigation	37
Battery Charger (INV)	89
Battery Equalize (CC Mode)	106
Battery Equalize (INV)	89
Battery Monitor Settings	
Battery Setup	112
Relay Mode	113
Relay Set Points.....	113
Reset to Factory Defaults	114
Shunt Enable.....	112
Battery Setup	112
Battery Voltage	34–36
Calibrate	102, 110
Charger Stages	104
Charging.....	40, 41
Charging with a Generator.....	60
Equalize.....	106
HBX Default Set Points.....	124
LEDs.....	30
Statistics.....	48
System Information	74

C

Calibrate Charge Controller.....	110
Calibrate the Inverter	102
CAT5 Cable	11, 13, 149
non-crossover.....	13
Charge Controller	
DataLog screen	53
Float Coordination.....	127
Charge Controller Settings	
Auxiliary Output.....	107
Battery Equalize	106
Calibrate	110
Charger	104
Grid-Tie Mode	107
MPPT	105
Reset to Factory Defaults	111

Restart Mode.....	110
Charger Settings	
Battery Charging... Error! Not a valid bookmark in entry on page 89	
Calibrate	110
Charger Hot Key.....	56–59
Current Limits.....	83
Temperature Compensation.....	106
Configuration Wizard	130
Creating new configurations.....	130
Menu Map for Existing Configurations	170
Menu Map for New Configurations.....	169
Menu Map for Restoring Configurations.....	171
Saving profiles	137
Saving profiles to an SD card.....	138
Using existing profiles	132
Connections.....	16–22
Connections to the MATE3.....	17
Contact Information.....	2
Control Wheel	65
Controls	64
Cool Fan (INV).....	91, 94, 97
csv file	123

D

Data Intervals.....	122
Data Log Example (CC).....	141
Data Log Example (FNDC).....	141
Data Log Example (System).....	123
Data Log File Format.....	123
Data Logging.....	122
Data Logs	139, 173
Data Stream	122
Network.....	79
Serial	79
DataLog Screen	53
Date and Time.....	77
DC Voltage.....	See Battery Voltage
Definitions	2
Dimensions	13
Display	29
Diversion Relay (Aux Mode)	109
Diversion Solid St (Aux Mode)	109
Divert DC (Aux Mode- INV)	91

E

elg file.....	143
Erasing Data Logs.....	141
Error Messages.....	43
Error Output (Aux Mode).....	108
Ethernet Addresses	78
Ethernet Port	12
Ethernet Ports for Port Forwarding.....	79

Event Logs.....	142, 175
Deleting.....	144
Reading from an SD Card	143
Saving	142
Event Messages.....	150

F

Factory Defaults	
Reset Charge Controller.....	111
Reset Inverter	103
Fault (INV).....	91, 94, 97
FCC.....	154
Features	11
Field Select Mode	68
Firmware	
Installing the Update	147
Revision	153
Update	145
Firmware Version.....	76
FLEXnet DC	See Battery Monitor
FLEXnet DC Advanced Control	128
Float (Aux Mode).....	109
FNDC.....	See Battery Monitor
Front Cover	64
Functions.....	11

G

Gen AC Input Voltage Limits (INV)	85, 87
Gen Alert (AGS).....	117
Gen Alert (INV)	91, 94, 97, 115
Generator Fault	31, 60, 61, 116, 121
Generator Start	See Advanced Generator Start
Global Charger Output Control	127
Graph Screens.....	54
Graphs	
Battery.....	45, 46, 54
Battery w/FNDC	51
Buy	44
Charge	44
Inverter	44
PV.....	54
Sell.....	45, 54
Shunt.....	51
SOC	51
Grid AC Input Voltage Limits (INV).....	85, 86
Grid Use Time.....	125
Grid-Tie Mode (Charge Controller)	107
Grid-Tie Sell (Inverter).....	101
Grid-Tied	33

H

HBX.....	124
----------	-----

High Battery Transfer (HBX)	124
Home Screens	33
Backup	36
Grid-Tied	35
Meter Bars	33
Off Grid	34
Types	33
Hot Keys	11, 55
AC INPUT	62
Charger	56
Events	61
Favorite	63
GEN	60
Inverter	55
HUB	11, 66, 100, 116, 125, 149
HUB Connections	16–22
HUB Port on MATE3	12
HUB ports	11

I

IEEE	101
Install	
Computer Direct	19
Computer Indirect	19
Computer Wireless	21
Computer Wireless	20
Direct Connection	17
General	16
HUB Connections	18
Stacked Inverters	18
Installer Information	80
Installer Password	81
Installer Settings	80
Challenge Installer Password	81
Change Installer Password	81
Set User Access Level	80
Inverter Settings	
AC Input Current Limit	83
AC Output	88
Auxiliary Output	90, 93, 96
Battery Charger	89
Battery Equalize	89
Calibrate	102
Gen AC Input Voltage Limits	85, 87
Grid AC Input Voltage Limits	85, 86
Grid-Tie Sell	101
Inverter Stacking	99
Low Battery	88
Reset to Factory Defaults	103
Search	82
Inverter Stacking	99
IP Address	See Ethernet Addresses

K

Kilowatt (kW) Measurements	49, 55, 60
Kilowatt-hour (kWh) Measurements	52, 53

L

LCD Display	77
LCD Display Screen	11
LEDs	
AC INPUT	31
Battery	30
Charger	30
Events LED	31
Favorites	31
Generator LED	31
Inverter	30
Location	29
Load Shed (INV)	90, 93, 96
Location	14
Low Batt Disconnect (Aux Mode)	110
Low Battery (INV)	88

M

Main Menu	71
Main Menu Structure	72
MATE3 Settings	
AGS Generator Exercise Schedule	121
AGS Load Start	118
AGS Mode	115
AGS Must Run Schedule	119
AGS Quiet Time Schedule	119
AGS Setup	116
AGS SOC Start	119
AGS Voltage Start	118
CC Float Coordination	127
CC Global Charging	127
Data Logging	122
Display AGS Timers	121
FNDC Advanced Control	128
High Battery Transfer	124
Reset to Factory Defaults	129
Measurements	
kilowatt (kW)	40, 44, 45, 47
Menu Maps	161
Battery Monitor Settings	167
Charge Controller Settings	166
Configuration Wizard	169
Device Data Logs	173
Event Logs	175
Inverter Settings	164, 165
Main Menu	162
MATE3 Settings	168
System Settings	163

Index

Meter Bars.....	33
Mounting	
Brackets	15
No Brackets.....	16
Requirements	14
MPPT.....	105
multi-drop network.....	11
MX60	17, 73, 127

N

Name of System.....	79
Navigation	64
Navigation Controls	65, 66
Navigation Keys	66, 67
Network Programming	
Direct	22
Indirect.....	23
Wireless Internet.....	26
Wireless Intranet.....	24
Networking	20
Night Light (Aux Mode)	109

O

Off Grid	33
Open-Circuit Voltage	52, 53, 105

P

Parts List	13
PassThru	33, 40, 107
Password.....	66, 71
Ports.....	66, 73, 79, 100, 116
Power Up	32
PV Voltage	52, 53, 54, 104

R

Recycling Information	5
Registration.....	177
Regulatory Specifications.....	4
Relay Mode.....	113
Relay Set Points.....	113
Remote (Aux Mode)	110, 115
Remote (INV).....	90
Required Resources.....	4
Reset Battery Monitor to Factory Defaults	114
Reset Charge Controller to Factory Defaults	111
Reset Inverter to Factory Defaults	103
Reset MATE3to Factory Defaults.....	129
Restart Mode	110
Restore.....	74
Restore from SD card	76

S

Safety	1, 3
Save	74
Save to SD card.....	75
Saving Data Logs	
FMCC	139
FNDC	140
Saving profiles	137
SD Card.....	11, 13, 74–76
Search	82
Sell Status	39
Set Point Adjust Mode	68
Set Points.....	68, 70, See also Adjusting Set Points
Settings Menu	
Battery Monitor.....	112
Charge Controller.....	104
Inverter	82
MATE3.....	115
Structure	73
System	73
Setup Complete	172
Shunt Enable	112
Shunts.....	49, 51, 112
Signal degradation.....	14
Silent mode.....	100
Soft Keys	11, 37
Battery.....	46, 47
Battery Graph	45
Charge Controller.....	52
Charge Graph	44
Grid	39
Inverter	40, 41, 42, 43
Inverter Graph.....	44
Inverter Input Select.....	38
Sell Graph.....	45
Sound.....	78
Specifications	153
Regulatory	153
Stacking.....	See Inverter Stacking
State of Charge	
AGS	119
Battery Setup.....	112
Display AGS Timers.....	121
Displayed by FNDC.....	47
FNDC Data Log.....	50
Generator Status Screen	60
Graph.....	51
HBX	124
LEDs	30
Symbols Used.....	1
System Settings	
Data Stream	79
Date and Time.....	77
Ethernet Addresses	78

Ethernet Ports79
 Firmware Version76
 Installer Information80
 Installer Settings.....80
 LCD Display77
 Save/Restore Configuration74
 Sound.....78
 System Information.....74
 System Name79
 System Type
 Backup 33, 37, 74
 Grid Tied..... 37, 74
 Grid-Tied 33, 35
 Off Grid..... 33, 34, 74

T

Temperature Compensation 106
 Timers
 Absorption (reading) 52, 53, 56
 Absorption (setting)..... 89, 104, 116
 AGS 119
 Equalize (setting)90, 93, 96, 106
 Float.....52
 Float (reading.....56
 Float (reading).....53
 Float (setting)89

Generator Run119
 Troubleshooting.....180
 Types of Settings (General) 70

U

User Access Levels (Settings) 80
 User Access Levels Menu Map CC.....166
 User Access Levels Menu Map FNDC.....167
 User Access Levels Menu Map INVERTER..... 164, 165
 User Access Levels Menu Map MATE3168
 User Access Levels Menu Map SYSTEM163

V

Vent Fan (Aux Mode)108
 Vent Fan (INV)..... 91, 94, 97

W

Warning Messages..... 42
 Warranty..... 2, 179
 How to Arrange for Service180
 RMA.....180
 Terms and Conditions.....179

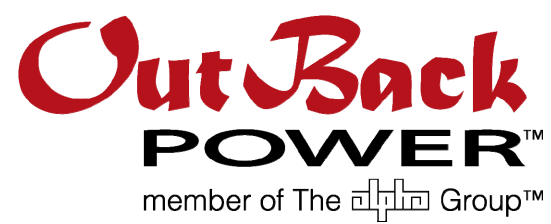

North America:
5917 – 195th Street N.E., #7
Arlington, WA 98223 USA
+1.360.435.6030

900-0117-01-00 Rev C