

# Conext™ Gateway

## Conext Gateway Owner's Guide

975-0806-01-01

January 2019



Copyright © 2019 Schneider Electric. All Rights Reserved.

Google Chrome, Microsoft, Windows, and Internet Explorer used with permission from Microsoft. Safari and Mac OS are trademarks of Apple Inc., registered in the U.S. and other countries. All other trademarks are owned by Schneider Electric Industries SAS or its affiliated companies.

### Exclusion for Documentation

UNLESS SPECIFICALLY AGREED TO IN WRITING, SELLER

(A) MAKES NO WARRANTY AS TO THE ACCURACY, SUFFICIENCY OR SUITABILITY OF ANY TECHNICAL OR OTHER INFORMATION PROVIDED IN ITS MANUALS OR OTHER DOCUMENTATION;

(B) ASSUMES NO RESPONSIBILITY OR LIABILITY FOR LOSSES, DAMAGES, COSTS OR EXPENSES, WHETHER SPECIAL, DIRECT, INDIRECT, CONSEQUENTIAL OR INCIDENTAL, WHICH MIGHT ARISE OUT OF THE USE OF SUCH INFORMATION. THE USE OF ANY SUCH INFORMATION WILL BE ENTIRELY AT THE USER'S RISK; AND

(C) REMINDS YOU THAT IF THIS MANUAL IS IN ANY LANGUAGE OTHER THAN ENGLISH, ALTHOUGH STEPS HAVE BEEN TAKEN TO MAINTAIN THE ACCURACY OF THE TRANSLATION, THE ACCURACY CANNOT BE GUARANTEED. APPROVED CONTENT IS CONTAINED WITH THE ENGLISH LANGUAGE VERSION WHICH IS POSTED AT <http://solar.schneider-electric.com/>.

**Document Number:** 975-0806-01-01

**Date:** January 2019

**Part Number:** 865-0329

### Contact Information

For country-specific details, please contact your local Schneider Electric Sales Representative or visit the Schneider Electric Solar Business website at: <http://solar.schneider-electric.com/>

### Information About Your System

As soon as you open your product, record the following information and be sure to keep your proof of purchase.

Serial Number	_____
Product Number	_____
Purchased From	_____
Purchase Date	_____

# Safety Information

## Important Information

Read these instructions carefully and look at the equipment to become familiar with the device before trying to install, operate, service or maintain it. The following special messages may appear throughout this documentation or on the equipment to warn of potential hazards or to call attention to information that clarifies or simplifies a procedure.

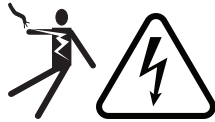

The addition of either symbol to a “Danger” or “Warning” safety label indicates that an electrical hazard exists which will result in personal injury if the instructions are not followed.



This is the safety alert symbol. It is used to alert you to potential personal injury hazards. Obey all safety messages that follow this symbol to avoid possible injury or death.

### **DANGER**

**DANGER** indicates a hazardous situation which, if not avoided, **will result in** death or serious injury.

### **WARNING**

**WARNING** indicates a hazardous situation which, if not avoided, **could result in** death or serious injury.

### **CAUTION**

**CAUTION** indicates a hazardous situation which, if not avoided, **could result in** minor or moderate injury.

### **NOTICE**

**NOTICE** is used to address practices not related to physical injury.

## Please Note

Electrical equipment should be installed, operated, serviced, and maintained only by qualified personnel. No responsibility is assumed by Schneider Electric for any consequences arising out of the use of this material.

A qualified person is one who has skills and knowledge related to the construction, installation, and operation of electrical equipment and has received safety training to recognize and avoid the hazards involved. For more information, see *Audience*.

## Product Safety Information

### **DANGER**

#### **HAZARD OF ELECTRIC SHOCK, EXPLOSION, ARC FLASH, AND FIRE**

- Read all instructions, cautionary markings, and all other appropriate sections of this guide before installing, operating, troubleshooting or performing maintenance on the Conext Gateway.
- Exercise extreme caution at all times to prevent accidents.
- These instructions are for use by qualified installers only.

**Failure to follow these instructions will result in death or serious injury.**

### **DANGER**

#### **HAZARD OF ELECTRIC SHOCK AND FIRE**

- Connect only to Safety Extra Low Voltage (SELV) circuits and power sources.
- All wiring must be done by qualified personnel to ensure compliance with all applicable installation codes and regulations.
- For Indoor Use Only.
- Do not disassemble. No user serviceable parts inside.

**Failure to follow these instructions will result in death or serious injury.**

## ***NOTICE***

### **EQUIPMENT DAMAGE**

- All cables connected to the Conext Gateway must run indoors and not be susceptible to lightning strikes.
- Turn OFF all devices before connecting cables. The Conext Gateway does not have an ON/OFF switch.
- Do not connect an Ethernet cable from the Conext Gateway to the WAN/MODEM port on the network router.
- Do not connect an Ethernet cable plug into a Xanbus port on the Conext Gateway.
- Do not connect a Xanbus RJ-45 cable plug into the 10/100 Ethernet port of the Conext Gateway.
- Do not connect any port on the Conext Gateway to an outside line or to a public telecommunication network.
- Ensure that the device connected on the Xanbus network is in standby mode before changing settings. Do not change any settings unless you are familiar with the device.
- Changes to any TCP/IP-related settings should only be performed by a qualified IT professional.

**Failure to follow these instructions can result in equipment damage or affect network performance.**

## ***NOTICE***

### **EQUIPMENT DAMAGE**

- Do not disassemble the Conext Gateway.
- See Warranty for instructions on obtaining service.
- The Conext Gateway contains no user serviceable parts. Attempting to service the Conext Gateway yourself will void your warranty.

**Failure to follow these instructions can result in equipment damage.**

**NOTE:** This device can be configured to connect to the Internet using port-forwarding in your network router's settings. There is a security risk in port-forwarding unencrypted network traffic over a public network (Internet). Use of a VPN or a secure tunnel to route Conext Gateway communication via the Internet is recommended.

# Audience

This guide is intended for use by anyone who plans to install and operate the Conext Gateway communications device as part of their power plant system.

Installation instructions are meant for installers only. The installers have training, knowledge, and experience in:

- Installing electrical equipment.
- Applying all applicable installation codes.
- Analyzing and reducing the hazards involved in performing electrical work.
- Selecting and using Personal Protective Equipment (PPE).
- Changing any TCP/IP-related settings.

Configuration, servicing, and maintenance must be performed by authorized service personnel only. Authorized service personnel meet the requirements for an installer, plus they have received specific training from the manufacturer on servicing the Conext Gateway.

# About

## Purpose

The purpose of this Owner's Guide is to provide explanations and procedures for installing, operating, configuring, maintaining, and troubleshooting the Conext Gateway.

## Scope

The Owner's Guide provides safety guidelines, planning, and setup information, procedures for installing the product, as well as information about troubleshooting the product. It does not include information on how to install, configure and use other Schneider Electric products.

## Firmware Revision

Some Conext Gateway features and functions described in this Owner's Guide may be incorporated with later firmware versions. This Owner's Guide is valid for Conext Gateway Version 1.01 and above. To view the firmware version on your product, see the Conext Gateway Status Information in the web user interface.

## Abbreviations and Acronyms

DHCP	Dynamic host configuration protocol
LED	Light emitting diode (used for indicator lights)
SELV	Safety extra low voltage
TCP/IP	Transmission control protocol/Internet protocol

## Related Products

**For more information about related products, refer to:**

- *Conext XW Pro Inverter/Charger Owner's Guide (part number: depends on configuration - see <http://solar.schneider-electric.com/>)*
- *Conext XW+ Inverter/Charger Owner's Manual (part number: depends on configuration - see <http://solar.schneider-electric.com/>)*
- *Conext Automatic Generator Start (AGS) Owner's Guide (part number: 975-0307-01-01)*
- *Conext System Control Panel (SCP) Owner's Guide (part number: 975-0298-01-01)*
- *Conext SW Inverter/Charger Owner's Guide (part number: depends on configuration - see <http://solar.schneider-electric.com/>)*
- *Conext MPPT 80 600 Solar Charge Controller Operation Guide (part number: 975-0540-01-01)*
- *Conext MPPT 60 150 Solar Charge Controller Operation Guide (part number: 975-0400-*

01-01)

- *Conext Battery Monitor Owner's Manual (part number: 975-0691-01-01)*

## **Related Information**

You can find more information about Schneider Electric's Solar products, as well as its services at <http://solar.schneider-electric.com/>.



# Contents

Safety Information .....	2
Audience .....	5
About .....	6
Purpose .....	6
Scope .....	6
Firmware Revision .....	6
Abbreviations and Acronyms .....	6
Related Products .....	6
Related Information .....	7
Overview .....	10
Introduction .....	11
Compatible Xanbus™ Components .....	11
Material List .....	12
Physical Features .....	13
Power Button Operation .....	14
LED Indicator Operation .....	14
26-pin Connector Pinouts .....	15
Types of Conext Gateway Networks .....	16
Power Sources for the Conext Gateway .....	16
Conext Gateway Web User Interface .....	17
Installation .....	20
Choosing a Location .....	21
Materials and Tools Required .....	22
Mounting the Conext Gateway .....	23
Wall Mount .....	23
DIN Rail Mount .....	23
Connecting the Conext Gateway to the Xanbus Network .....	24
Connecting the Conext Gateway to the Internet .....	26
Turning On the Conext Gateway .....	28
Turning Off the Conext Gateway .....	29
Power Cycling .....	29
Configuration .....	30
Using the Conext Gateway Web App via Wi-Fi Access Point (AP) .....	31
Web Security .....	32
Configuring the Conext Gateway .....	32
Logging in to the Conext Gateway Web Application .....	34
Changing the Password .....	35

Changing Conext Gateway Settings .....	37
Plant Setup .....	38
Time Setup .....	38
Import and Export Settings .....	39
Units .....	40
Modbus Settings .....	40
Restarting the Conext Gateway .....	41
Install Package .....	42
Changing Device Settings .....	43
Upgrading Firmware .....	45
Installing Conext Gateway Upgrades From a USB Drive .....	45
Installing Conext Gateway Upgrades Remotely .....	46
Upgrading Other Device Firmware .....	46
<b>Monitoring .....</b>	<b>48</b>
Monitoring LED Indicators .....	49
Startup .....	49
Monitoring the Power Plant .....	49
<b>Troubleshooting .....</b>	<b>52</b>
Events .....	53
<b>Specifications .....</b>	<b>56</b>
Electrical Specifications .....	57
Physical Specifications .....	57
Features .....	58
Regulatory .....	58
FCC Regulatory Compliance .....	58
ISED Regulatory Compliance .....	59
Simplified EU Declaration of Conformity .....	60
Schneider Electric Products that Work with the Conext Gateway .....	60
Dimensions .....	61
<b>Using Chrome to Install the Conext Gateway Security Certificate .....</b>	<b>62</b>
Installing the Conext Gateway Security Certificate .....	63

# 1 Overview

## What's in This Chapter?

<b>Introduction</b> .....	<b>11</b>
<b>Compatible Xanbus™ Components</b> .....	<b>11</b>
<b>Material List</b> .....	<b>12</b>
<b>Physical Features</b> .....	<b>13</b>
Power Button Operation .....	14
LED Indicator Operation .....	14
26-pin Connector Pinouts .....	15
<b>Types of Conext Gateway Networks</b> .....	<b>16</b>
<b>Power Sources for the Conext Gateway</b> .....	<b>16</b>
<b>Conext Gateway Web User Interface</b> .....	<b>17</b>

## Introduction

The Conext Gateway is a multi-function communication device that provides an overall view of system performance for residential power monitoring systems. It also provides a communications gateway between a network of Xanbus™-enabled devices and Modbus devices. Operators can configure the Conext Gateway system and monitor performance with third party software packages and building management systems.

### **DANGER**

#### **HAZARD OF ELECTRIC SHOCK, EXPLOSION, ARC FLASH, AND FIRE**

- Connect only to Safety Extra Low Voltage (SELV) circuits and power sources.
- All wiring must be done by qualified personnel to ensure compliance with all applicable installation codes and regulations.
- For Indoor Use Only.
- Do not disassemble. No user serviceable parts inside.

**Failure to follow these instructions will result in death or serious injury.**

Other features of the Conext Gateway include:

- Compatibility—connects directly to Xanbus-enabled devices
- Real-time clock—keeps time for the entire system
- Non-volatile memory—preserves the latest Conext Gateway settings if power is interrupted or network communication is disrupted.
- Firmware storage and upgrade capability—uses the Conext Gateway to upgrade or downgrade firmware for Xanbus-enabled devices on the network.
- Cloud storage capability—Save and synchronize settings with the Conext Gateway cloud service.

## Compatible Xanbus™ Components

The Conext Gateway works with several Schneider Electric products including:

- Conext XW Pro Inverter/Charger
- Conext XW+ Inverter/Charger
- Conext Automatic Generator Start (AGS)
- Conext System Control Panel (SCP)
- Conext SW Inverter/Charger
- Conext MPPT 80 600 Solar Charge Controller
- Conext MPPT 60 150 Solar Charge Controller
- Conext Battery Monitor

For details on specific models supported, see *Specifications on page 1*. The Conext Gateway supports up to a maximum of 20 devices on a Xanbus network depending on the device types.

## Material List

Figure 1 Material list

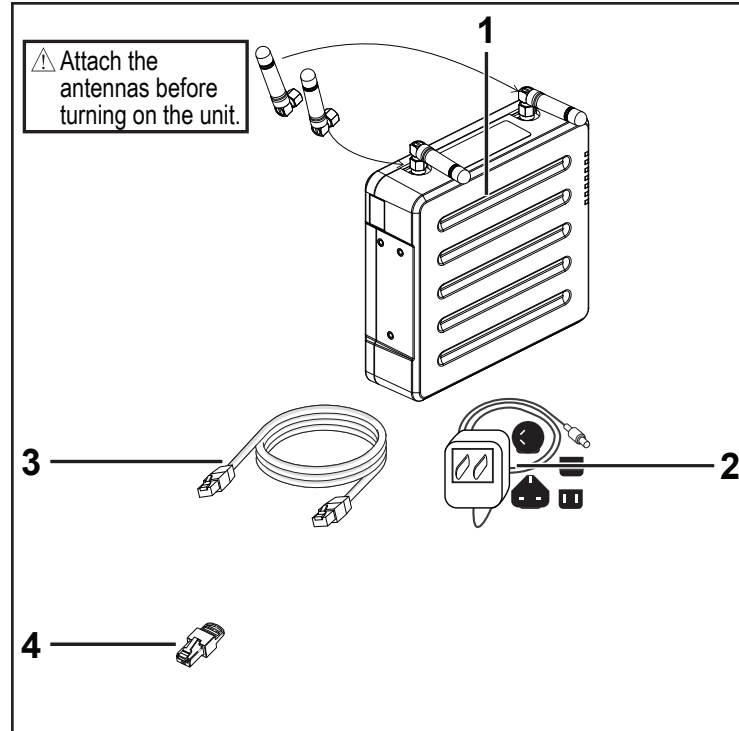

**NOTE:**

- Do not discard the packaging box.
- The Wi-Fi password is printed on the unit.
- Install the antennas before turning on the unit.

1	Conext Gateway unit
2	AC/DC power adapter with interchangeable plugs
3	Ethernet cable (CAT5e)
4	Network terminator
not shown	<ul style="list-style-type: none"> <li>• 8GB Micro SD card</li> <li>• 75mm DIN rail</li> <li>• CAN terminator</li> <li>• 26-pin connector (see <i>Physical Features on page 13</i>)</li> </ul>

# Physical Features

The following illustration shows the Conext Gateway. The tables in the following sections contain descriptions of the connectors, indicators, and data ports on the Conext Gateway.

Figure 2 Ports, buttons, and indicators

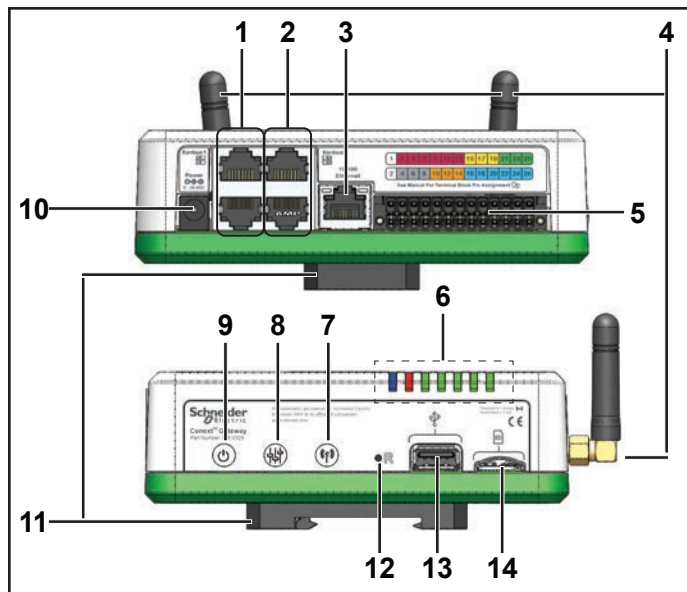

1	Xanbus ports 1	1st pair of Xanbus ports used for Xanbus communications
2	Xanbus ports 2	2nd pair of Xanbus ports used for Xanbus communications
3	Ethernet port	Use to connect to the internet via an Ethernet cable.
4	Antenna	Adjustable antenna for Wi-Fi transmission and reception
5	26-pin port	Use for connecting the 26-pin connector.
6	LED indicators	LED indicators are used for signifying device, communication, and monitoring statuses.
7	Wi-Fi button	Press and hold to turn on or turn off Wi-Fi setup network.
8	Settings button	Press to enter device configuration mode.
9	Power button	Press to enable/disable the Conext Gateway.
10	Power port	Use for connecting the AC/DC power plug.
11	DIN rail clip (detachable)	Use for attaching the device to a 35mm EN50022 DIN rail. The clip can be detached and re-attached to one of the narrow sides of the device.
12	Reset pinhole button	Press to reset the Conext Gateway.
13	USB port	Use for firmware updates only. Do not use to charge USB devices.
14	SD card slot	Insert a mini-SD card (up to 128GB) for data storage.

## Power Button Operation

Table 1 Power button operation

Press and hold duration	Number of beeps	Conext Gateway operation
3 seconds	1	Conext Gateway will restart
6 seconds	2	Conext Gateway will shutdown
9 seconds	3	User settings will be reset and Conext Gateway will restart
12 seconds	4	Factory default settings will be reset and Conext Gateway will restart

## LED Indicator Operation

Figure 3 LED indicators



	Green	Power	The Conext Gateway is powered on.
	Green	Memory	Device is logging data to internal memory when flashing.
	Green	Cloud	Device is actively transferring data with the cloud.
	Green	Xanbus	Device is actively transferring data with a Xanbus device/s.
	Green	Modbus	Device is actively transferring data with a Modbus device/s.
	Red	Event	Devices on the Power system have events to report.
	Blue	Wi-Fi	Wi-Fi connectivity is established.

## 26-pin Connector Pinouts

Figure 4 26-pin connector

Bottom Row	
2	9–24VDC power input
4	GND
6	12VDC digital input 1
8	12VDC digital input 2
10	ISO1 CAN GND
12	ISO1 CAN L
14	ISO1 CAN H
16	ISO2 RS485 GND
18	ISO2 RS485 1A
20	ISO2 RS485 1B
22	ISO2 RS485 GND
24	ISO2 RS485 2A
26	ISO2 RS485 2B

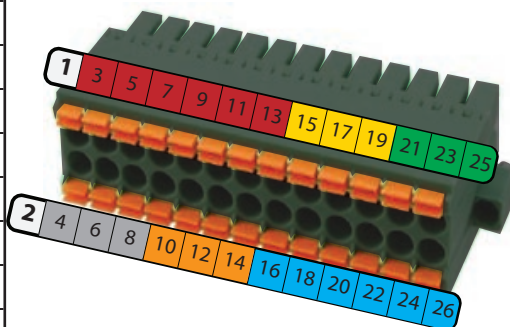

Top Row	
1	GND
3	0–10VDC analog input 1
5	0–10VDC analog input 2
7	GND
9	4–20mA input 1
11	4–20mA input 2
13	GND
15	Relay 1 NO
17	Relay 1 COM
19	Relay 1 NC
21	Relay 2 NO
23	Relay 2 COM
25	Relay 2 NC



## Types of Conext Gateway Networks

The Conext Gateway can interface with different LAN devices using wired or wireless connections, so you can configure your Xanbus devices and monitor your power system performance.

- Conext Gateway on Xanbus (two separate networks can be supported)
- Conext Gateway on Modbus (via the 26-pin connector)
- Conext Gateway on Local Area Network (LAN, via Ethernet or Wi-Fi)  
When the Conext Gateway is part of a LAN, you can access the Conext Gateway web user interface from a computer on the same LAN via a wireless or wired LAN connection.

An Ethernet connection is required between the Conext Gateway and a router and computer for configuring the Conext Gateway.

## Power Sources for the Conext Gateway

The Conext Gateway consumes an average of 2 W under most operating conditions and up to 10 W maximum. The power sources connected to the Conext Gateway must be capable of providing this power requirement.

**There are three power sources for the Conext Gateway:**

- AC/DC power adapter (supplied)
- Xanbus-enabled device via CAT5 or CAT5e cable (Xanbus cable)
- 9–24 V DC power input connections on the 26-pin connector

All three sources can be used alone or simultaneously. Typically, the AC/DC power adapter (supplied) is used as a primary source with either a Xanbus connection or the 26-pin connector as secondary sources. See *"Physical Features"* on page 13 for connection locations.

### DANGER

#### HAZARD OF ELECTRIC SHOCK AND FIRE

Connect only to Safety Extra Low Voltage (SELV) circuits and power sources.

**Failure to follow these instructions will result in death or serious injury.**

Safety Extra Low Voltage (SELV) is a designation that refers to a circuit in which the voltages within the circuit and from the circuit to ground have values that are not a shock hazard, under both normal and single fault conditions.

**In the Conext Gateway, the SELV circuits and their intended connections are:**

- The supplied AC/DC power adapter connected to the power port of the Conext Gateway.
- Xanbus communications and power which come from SELV circuits on Xanbus-enabled Schneider products.
- 9–24 V DC power input connections which must be SELV and are connected to the Conext Gateway via the 26-pin connector.
- Ethernet circuits or Class 2 circuits (Class 2 is a 24V, 100VA limited circuit).

## Conext Gateway Web User Interface

This section describes the elements of the web-based user interface for the Conext Gateway. This interface is used to check the status of the Conext Gateway, configure the communications options, monitor and log data for your network, and perform upgrades. The menu bar contains icons for going to the home screen or setup screen, linking to the Schneider Electric Web site, and closing or logging out of the web user interface.

**Correct operation of the web user interface has been verified with the following browsers:**

- Google Chrome™ 34.x or later
- Microsoft® Windows® Internet Explorer® 10.x or later
- Safari® 5.x or later

**IMPORTANT:** JavaScript and cookies must be enabled in your Web browser for the interface to function.

To access the web user interface, log in with a user name and password. For more details see *Logging in to the Conext Gateway Web Application on page 34*.

Figure 5 Web user interface

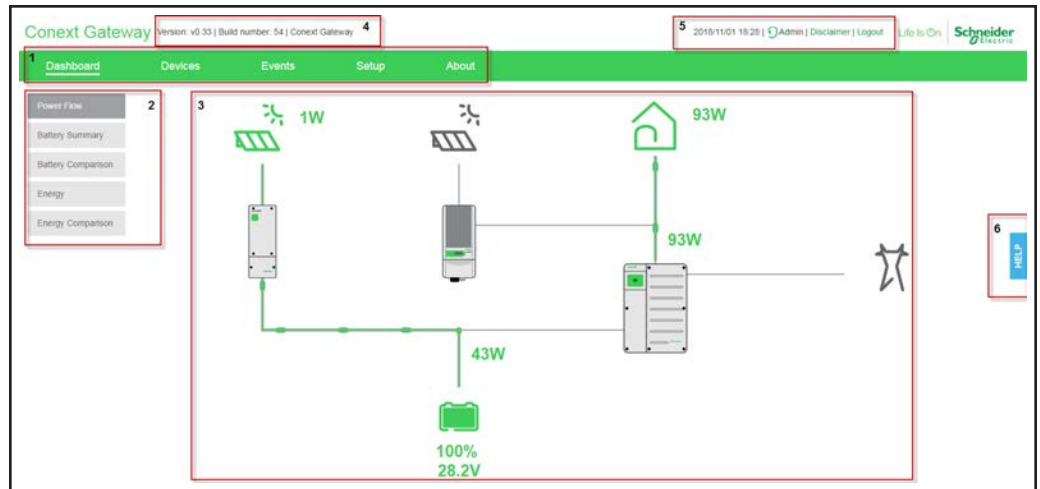

1	<b>Main menu bar</b> – displays major menu items including the Dashboard, Devices, Events, and Setup commands. It includes <b>About</b> , which shows Conext Gateway device information.
2	<b>Sub-menu tabs</b> – displays sub-menu items expanding commands associated with the major menu items.
3	<b>Main display area</b>
4	<b>Web app version and build number</b>
5	<b>Information bar</b> – displays the system date, time, and user type. Also, contains a link to the Disclaimer page and Logout.
6	<b>Floating Help tab</b>



## 2 Installation

### What's in This Chapter?

<b>Choosing a Location</b> .....	<b>21</b>
<b>Materials and Tools Required</b> .....	<b>22</b>
<b>Mounting the Conext Gateway</b> .....	<b>23</b>
Wall Mount .....	23
DIN Rail Mount .....	23
<b>Connecting the Conext Gateway to the Xanbus Network</b> .....	<b>24</b>
<b>Connecting the Conext Gateway to the Internet</b> .....	<b>26</b>
Turning On the Conext Gateway .....	28
Turning Off the Conext Gateway .....	29
Power Cycling .....	29

## Choosing a Location

Figure 6 Location choices

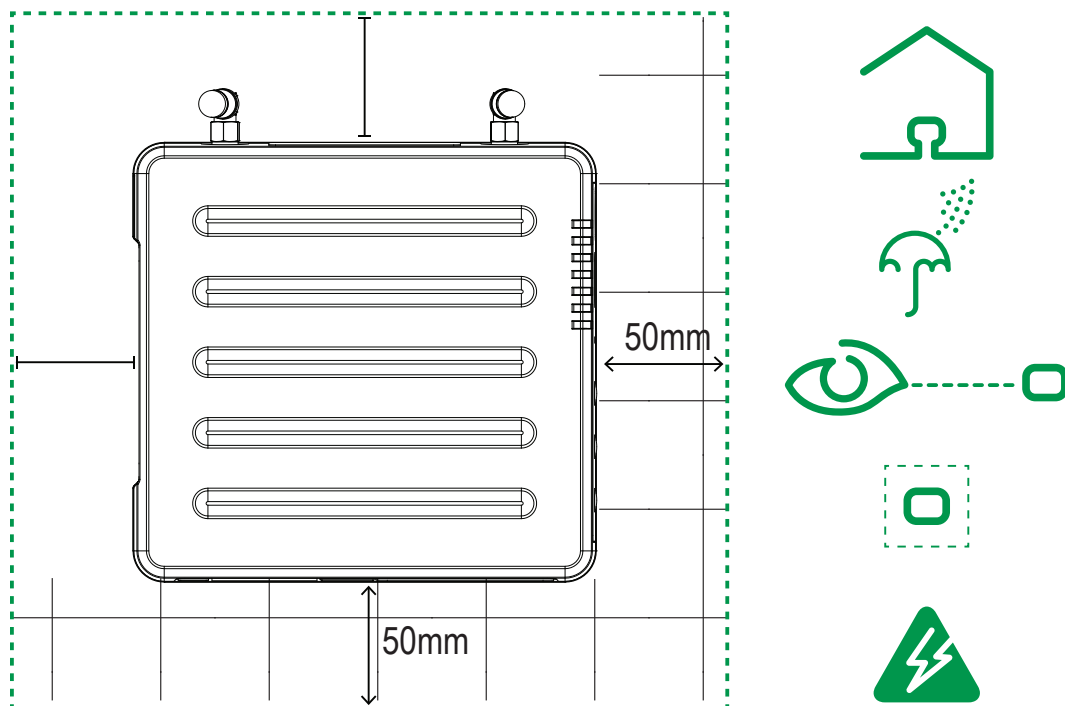

- Choose a clean, dry, easily accessible location indoors.
- If you mount the Conext Gateway on a wall, the recommended height is at eye-level so that you can clearly see the LED indicators and have easy access to the data and communication ports.
- All of the ports on the Conext Gateway are accessible from the sides of the device when mounted on a wall or DIN rail. Clearance of at least 2 inches (50 mm) around the device is needed to allow for the bending radius of cables that connect to the Conext Gateway.
- You should not run cables through conduits that can be exposed to lightning strikes. The following are recommended maximum cable lengths in a Conext Gateway system:
  - 131 feet (40 m) Total Xanbus network
  - 328 feet (100 m) Router to Conext Gateway
  - 164 feet (50 m) Modbus Master (RS 485) to Conext Gateway

## Materials and Tools Required

The following materials are supplied in the Conext Conext Gateway package:

- One Conext Gateway unit
- One Conext Gateway Quickstart Guide
- One AC/DC power supply adapter
- One 8 GB micro SD card
- One CAT5e Ethernet cable (7-ft)
- One 26-pin connector
- One 75 mm DIN rail

The following materials and tools are not supplied but are required to complete the installation:

- CAT5e Ethernet cable(s)
- Modbus network cables(s)
- Wire stripper
- Ferrules
- Screwdriver set
- Pliers
- Diagonal cutter or heavy duty scissors

# Mounting the Conext Gateway

## Wall Mount

### To mount the Conext Gateway on a wall:

1. Choose the location for mounting the device.
2. Using the diagram in the *Conext Gateway Quickstart Guide* (part number: 975-0804-01-01), mark the mounting holes on the wall with a pencil.
3. The holes must be at the same height and 4 7/16 inches (112 mm) apart.
4. Insert the two anchors and mounting screws supplied in the marked locations on the wall, leaving a space of about ¼ inch (6 mm) between the wall and screw head.
5. If you are mounting the Conext Gateway on concrete, the supplied anchors and mounting screws are not suitable. Use two mounting screws that are equivalent to #6 screws.
6. Place the Conext Gateway on the mounting screws, and confirm a snug fit before going to the next step.
7. Connect the wiring and cables.

## DIN Rail Mount

### To mount the Conext Gateway on the DIN Rail:

1. Use a standard 35-mm “top hat” DIN rail (EN50022).
2. You may choose to move the mounting clip to the side as shown.

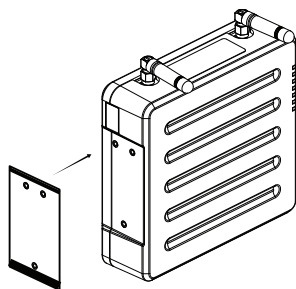

3. Attach the device to the DIN rail. Hook the bottom catch of the clip onto the rail, pull up a little to retract the bottom catch and hook the top catch of the clip onto the rail.

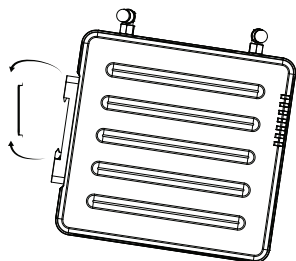

4. Connect the wiring and cables.



## Connecting the Conext Gateway to the Xanbus Network

### To connect the Conext Gateway to the Xanbus network:

1. Connect the Conext Gateway to the Xanbus network using daisy chain configuration.
  - a. Xanbus components can be arranged in any order.
  - b. The left connectors are *Xanbus 1* and the right connectors are *Xanbus 2*.
  - c. Do not connect two end devices together to form a closed loop configuration.
2. Use a network terminator at both ends of the network. See *Figure 7*.
  - a. Both networks require two Xanbus terminations; *Xanbus 1* and *Xanbus 2*, if the second network is used. *Xanbus 2* does not need terminators if it is not used.
3. Do not interconnect two separate Xanbus networks, meaning, do not daisy chain one Xanbus network with another.
  - a. Use only one pair of Xanbus ports for the daisy chain.
  - b. If you only have one Xanbus network use *Xanbus 1*.
  - c. If you have two separate Xanbus networks connect the second network to *Xanbus 2*.
  - d. Devices on the *Xanbus 1* network will not communicate with devices on the *Xanbus 2* network.
  - e. See *Figure 7* for *Xanbus 1* pair of ports - one top and one bottom.

### **NOTICE**

#### **EQUIPMENT DAMAGE**

- Do not connect a Xanbus cable plug into the Ethernet port on the Conext Gateway.
- Connect only to Xanbus ports and use the network terminators to each end device in the daisy chain.
- Do not connect *Xanbus 1* and *Xanbus 2* together as the system will become unstable.

**Failure to follow these instructions can result in equipment damage.**

Figure 7 Sample Xanbus network

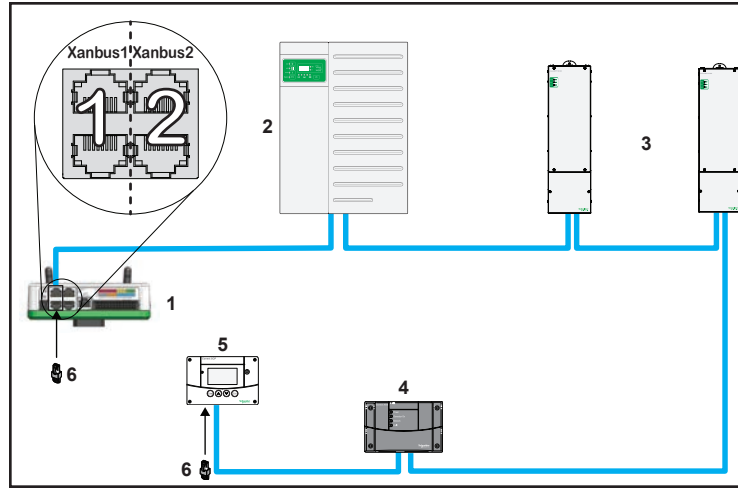

1	Conext Gateway unit
2	Conext XW Pro
3	MPPT 80 600
4	Conext AGS (automatic generator start)
5	Conext SCP (system control panel)
6	Network terminators

**NOTE:** This Xanbus 1 network is for illustration purpose only.

## Connecting the Conext Gateway to the Internet

Before connecting a computer and router to the Conext Gateway, make sure it meets the following prerequisites.

- Microsoft® Windows® 7 or later
- Mac OS® X 10.4.8. or later
- Google Chrome™ 34.x or later
- Microsoft® Windows® Internet Explorer® 10.x or later
- Safari® 5.x or later
- JavaScript and cookies must be enabled in your web browser.
- Router - the network router must be able to supply DHCP addresses automatically to connected devices. If your network router does not support automatic DHCP, refer to your network router's user guide or contact your system administrator.

**To connect the Conext Gateway to a Computer on an Ethernet Network:**

### ***NOTICE***

#### **EQUIPMENT DAMAGE**

- Do not connect an Ethernet cable from the Conext Gateway to the MODEM port on the network router.
- Do not connect an Ethernet cable plug into a Xanbus port on the Conext Gateway.

**Failure to follow these instructions can result in equipment damage.**

1. Make sure the computer and network router are turned on and the Conext Gateway is not turned on. Make sure the network router selected has DHCP enabled.
2. Connect one end of an Ethernet cable to the computer's network port.
3. Connect the other end of the Ethernet cable to a vacant Ethernet/LAN port on the network router.
4. Connect one end of the Ethernet cable (supplied) to the LAN port on the network router.
5. At this stage, the network router should be on, but the LED showing port activity on the router will not show any indication.
6. Connect the other end of the Ethernet cable to the Conext Gateway.
7. At this stage, the Ethernet cable should be the only cable plugged into the Conext Gateway.

Figure 8 Ethernet connection (LAN)

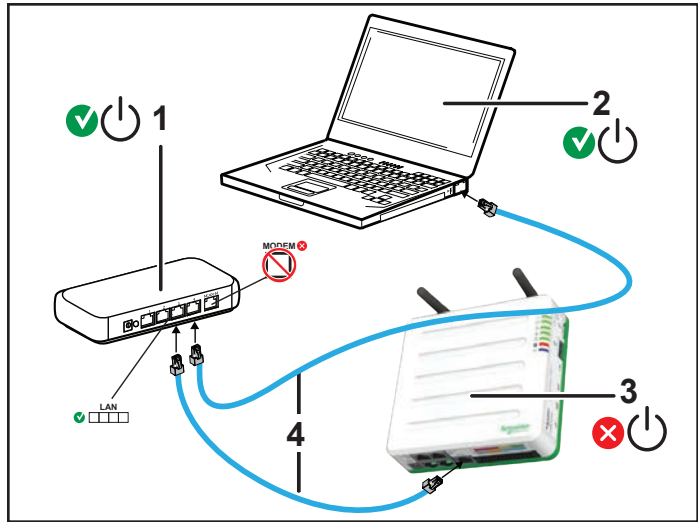

1	Router/modem
2	Laptop
3	Conext Gateway unit
4	Ethernet cables

## Turning On the Conext Gateway

Before turning on the Conext XW+, you must connect it to a power source.

Figure 9 Power connections and button

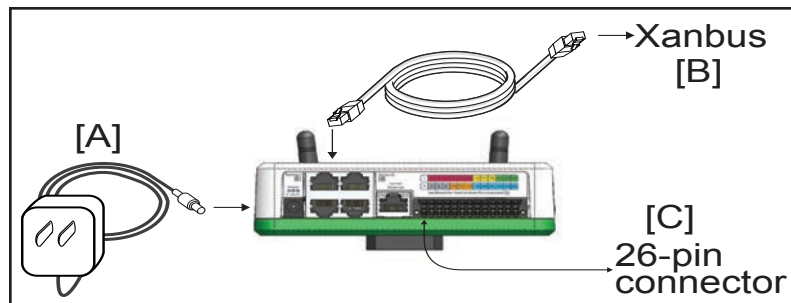

**NOTE:** In the 26-pin connector, pin 1 connects to a 9-24VDC source and pin 2 connects to GND Power input. See "26-pin connector" on page 15.

### To turn on the Conext Gateway:

1. Select a power source to the Conext Gateway. You can choose either of the following:
  - a. Plug the **(A)** AC/DC power adapter into the AC wall outlet
  - b. Connect the Conext Gateway to the Xanbus network **(B)** using Ethernet cables
  - c. Provide 9–24 VDC power via by connecting to a power input source via the 26-pin connector **(C)**
2. Connect **(A)**, **(B)**, or **(C)**'s connector to Conext Gateway's Power port for **(A)**, Xanbus port for **(B)**, or terminal block for **(C)**, respectively.
3. Connect **(A)**'s power plug to an AC wall outlet or **(B)**'s other Xanbus cable connector to a Xanbus port on a Xanbus device. Alternatively, connect **(C)**'s pins 1 & 2 to a DC-powered device.
4. Observe the LED indicators and wait for the Power LED to light up (solid). The Conext Gateway is now turned on.
5. Proceed to "Logging in to the Conext Gateway Web Application" on page 34.

**⚠ WARNING**

**PHYSICAL INJURY HAZARD**

Xanbus is a valid power source for the Conext Gateway. However, for the first time set-up, using Xanbus as a power source is not recommended. the Conext Gateway clock will override the other Xanbus devices' clocks and could trigger unintentional time-based events. Therefore, DO NOT connect the Conext Gateway to the Xanbus network prior to setting up the internal clock of the Conext Gateway. Refer to "Time Setup" on page 38 for instructions. If Xanbus is the only source powering the Conext Gateway, after installation verify the time settings in all devices.

**Failure to follow these instructions can result in death, serious injury, or equipment damage.**

## Turning Off the Conext Gateway

To turn off the Conext Gateway:

- Press the Power button according to the settings in *Table 1 on page 14* or use the web user interface to shut down the unit and turn it off.

Figure 10 Power button

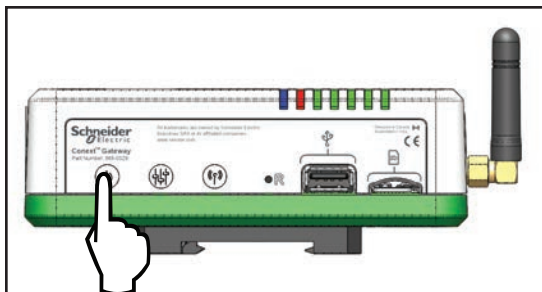

## Power Cycling

To power cycle the Conext Gateway:

1. Turn the Conext Gateway OFF.
  - a. Press and hold the Power button according to the settings in *Table 1 on page 14* or use the web user interface.
  - b. Remove the power connections to the Conext Gateway.
2. Wait ten seconds before the next step.
3. Ensure that there is no USB thumb drive inserted in the USB Host port.
4. Turn the Conext Gateway ON.
  - a. Plug and connect the Conext Gateway to a power source.

## 3 Configuration

### What's in This Chapter?

<b>Using the Conext Gateway Web App via Wi-Fi Access Point (AP)</b> .....	<b>31</b>
<b>Web Security</b> .....	<b>32</b>
<b>Configuring the Conext Gateway</b> .....	<b>32</b>
<b>Logging in to the Conext Gateway Web Application</b> .....	<b>34</b>
<b>Changing the Password</b> .....	<b>35</b>
<b>Changing Conext Gateway Settings</b> .....	<b>37</b>
Plant Setup .....	38
Time Setup .....	38
Import and Export Settings .....	39
Units .....	40
Modbus Settings .....	40
<b>Restarting the Conext Gateway</b> .....	<b>41</b>
Install Package .....	42
<b>Changing Device Settings</b> .....	<b>43</b>
<b>Upgrading Firmware</b> .....	<b>45</b>
Installing Conext Gateway Upgrades From a USB Drive .....	45
Installing Conext Gateway Upgrades Remotely .....	46
Upgrading Other Device Firmware .....	46

## Using the Conext Gateway Web App via Wi-Fi Access Point (AP)

**NOTE:** This procedure is not about connecting to a local area network (LAN) via Wi-Fi.

In order to establish a user interface with Conext Gateway, a direct Wi-Fi connection is necessary. The following are the pre-requisites:

- Laptop with Microsoft® Windows® 7 or later, Mac OS® X 10.4.8. or later
- Wi-Fi setting for the laptop is enabled
- Web browser such as Google Chrome™ 34.x or later, Microsoft® Windows® Internet Explorer® 10.x or later, Safari® 5.x or later
- JavaScript and cookies must be enabled in your web browser.

Figure 11 Wi-Fi connection requirements

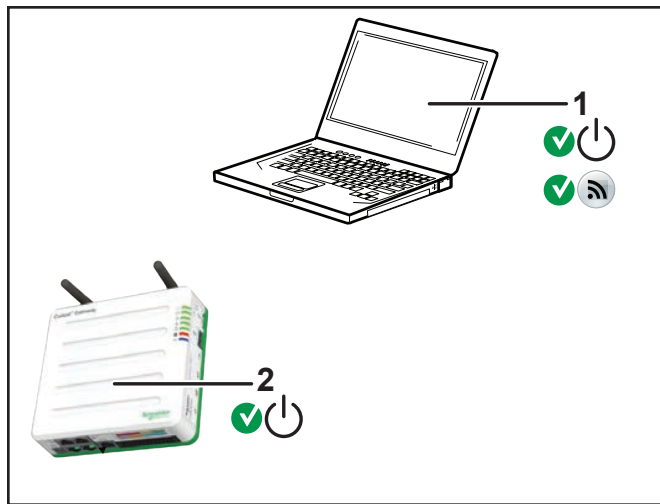

1	Laptop
2	Conext Gateway unit. Wi-Fi password label is on the back panel.

**To connect:**

1. Make sure the laptop and Conext Gateway are turned on.
2. Enable Wi-Fi on the laptop, if not already.



3. Open Wi-Fi Settings, then look for and connect to the Conext Gateway SSID. For example, you may look for something similar to **ConextGateway\_fe808b** below.

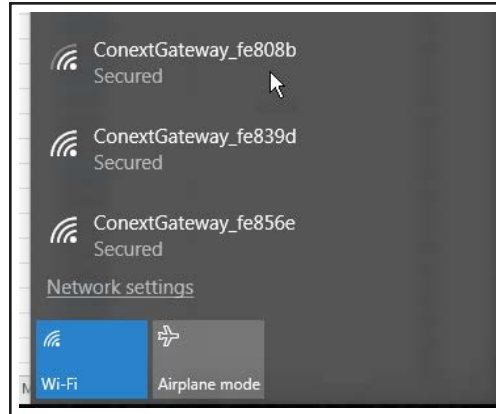

4. Enter the **Password** when prompted.  
**NOTE:** The password is printed on a label on the back panel of the Conext Gateway unit.
5. Proceed to *Logging in to the Conext Gateway Web Application*.

## Web Security

When you access the Conext Gateway web user interface you may see a warning stating that the web page is not trusted or the web page is not secure. This occurs because the Conext Gateway security certificate is not installed on your computer's operating system. You can elect to proceed anyway, if you are on a private local area network. Alternatively, you may choose to download the web security certificate from the Conext Gateway and install it on your PC. See *"Installing the Conext Gateway Security Certificate" on page 63* for instructions on how to do this using the Chrome web browser on Windows. Other browsers will have similar mechanisms for installing the certificate.

## Configuring the Conext Gateway

To complete Conext Gateway setup, you must successfully complete the procedures in *Installation on page 20*. Make sure the Conext Gateway is connected, the Power LED is on, and the Event LED is off. Your Xanbus devices should still be in standby mode.

When you initially log in to the web user interface, most of the setup information appears automatically with their default values. Some information must be changed (such as passwords), some information can be modified as needed, and some information can only be modified by a qualified IT professional.

The following items are part of the Conext Gateway configuration process:

### Primary

1. Log in - see *"Logging in to the Conext Gateway Web Application" on page 34*
2. Change the password - see *"Changing the Password" on page 35*

3. Set plant site information - see *"Plant Setup"* on page 38
4. Set the system time - see *"Time Setup"* on page 38

**Optional/Occasional**

1. Configure general device settings - see *"Changing Device Settings"* on page 43
2. Upgrade the device firmware - see *"Upgrading Firmware"* on page 45

## Logging in to the Conext Gateway Web Application

1. If you have connected the Conext Gateway via Wi-Fi, go to the IP address <https://191.168.100.1> to access the web user interface.
2. If you have connected the Conext Gateway via Ethernet use the following steps:
  - a. Insert a blank USB drive into the Conext Gateway USB port. Ensure there are no firmware upgrade files on this USB drive.
  - b. After the Conext Gateway beeps twice, remove the USB drive.
  - c. Insert the USB drive into your laptop USB port.
  - d. Copy the HTML file to your laptop.
  - e. Remove the USB drive from your laptop.
  - f. Open the HTML file and click the link to the IP address of the Conext Gateway.
3. Bookmark this address. **IMPORTANT:** The web address is a locally and privately assigned (LAN) device address that is also protected by a firewall.
4. Select your User Name. Select **Admin**.
5. Enter your Password. Initial password is **Admin123**.
6. When prompted, change the initial password immediately to protect the device from unauthorized users and to enable changes to device settings. This is an important step to follow.

**NOTE:** To perform administrative functions such as a firmware update, set User Name to **Admin**. Settings are disabled until the initial password is changed.

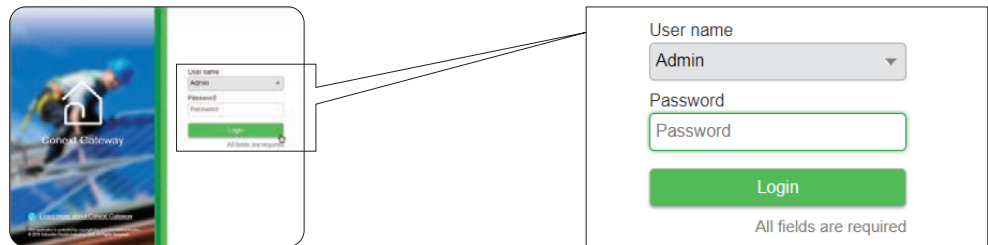

6. Change the Conext Gateway SSID and network password.
  - a. Go to **Setup > Network > Wifi Access Point Settings**
  - b. (Optional) Replace the current Wi-Fi network name under the **SSID** field with an appropriate name. You are limited to 64 alphanumeric characters including symbols.
  - c. Replace the current password under the **Password** field with 10 or more alphanumeric characters including symbols.
  - d. Click **Apply** to save the new password and/or SSID.

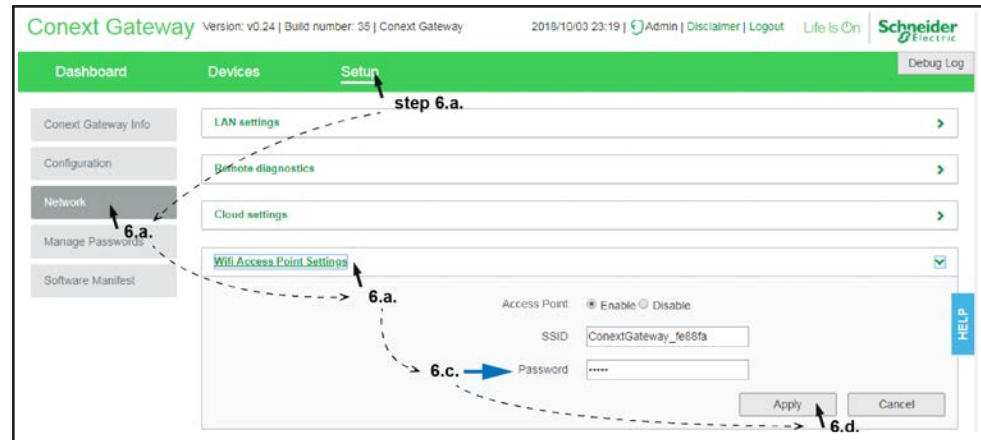

## Changing the Password

### What to expect when logging in for the first time:

- When logging in to the web application for the first time, either as **Admin** or **User** or **Guest**, the system will automatically ask you to change the password from the factory default **Admin123** or **User123** or **Guest123**, respectively.

Figure 12 Message box to change password

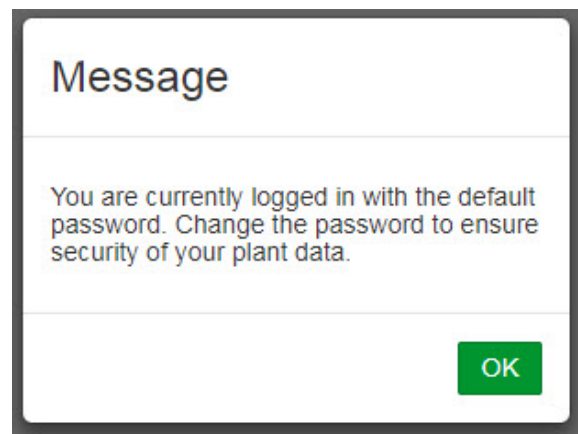

- Click **OK** and follow the instructions to change the password.

Figure 13 Password screen

### Change password

You are currently logged in with the default password. Change the password to ensure security of your plant data.



User name

Old password

New password

Confirm password

- 6 – 12 characters
- At least one capital letter
- At least one number



- You may have to log in again after changing the initial password.

To change the password after the initial log in:

Figure 14 Change password setting

1. Click **Setup > Manage Passwords > Change Passwords**.
2. Select the **User name** type. **Note:** Admin-level can change all passwords. User-level can change User and Guest passwords. Guest-level cannot change any passwords.
  - Admin
  - User
  - Guest
3. Enter the **Old password**.
4. Enter the **New password**.
5. Enter the **Confirm password**.
6. Click **Apply**. Your settings will be immediately applied.

## Changing Conext Gateway Settings

The procedures for configuring the other Conext Gateway Settings are described in the following sections.

**To change Conext Gateway settings:**

1. In the main menu bar, click **Setup > Configuration**.  
The **Configuration** settings appear in the main display area.
2. Click any of the following settings.
  - a. Plant setup - see *Plant Setup on page 38*
  - b. Time setup - see *Time Setup on page 38*
  - c. Import & export settings - see *Import and Export Settings on page 39*
  - d. Units - see *Units on page 40*
  - e. Modbus settings - see *Modbus Settings on page 40*
  - f. Restart Conext Gateway - see *Restarting the Conext Gateway on page 41*
  - g. Install package - see *Install Package on page 42*

- With only a few exceptions, you may save a setting by clicking **Apply** or ignore changes by clicking **Cancel**.  
That portion of the window expands to display the change options for that setting. The size and content of the expanded window varies depending on the setting type.

## Plant Setup

It is recommended to name the plant site to distinguish it from other installations in your power system.

Figure 15 Plant setup screen

### To enter plant information:

- Click **Setup > Configuration > Plant setup**.
- Enter a **Friendly name**. Choose a name that can easily identify the plant site to your customers.
- Enter the **Installed AC capacity (kW)**.
- Enter the **Installed year**.
- Click **Apply**. Your settings will be immediately applied.

## Time Setup

You can set the time zone plus date and time in the **Time setup** menu.

Figure 16 Time setup screen

**To change the Conext Gateway time:**

1. Click **Setup > Configuration > Time setup**.
2. Select the **Time zone**. This time setting overrides settings on other devices in the system.
3. Enter the date and time by clicking the calendar icon beside **Date & time**.
4. Click **Apply**. Your settings will be immediately applied.

## Import and Export Settings

This command setting allows you to either export the configuration of this Conext Gateway to another Conext Gateway unit or import the configuration of another Conext Gateway to supersede this Conext Gateway unit.

Figure 17 Import & export setup screen

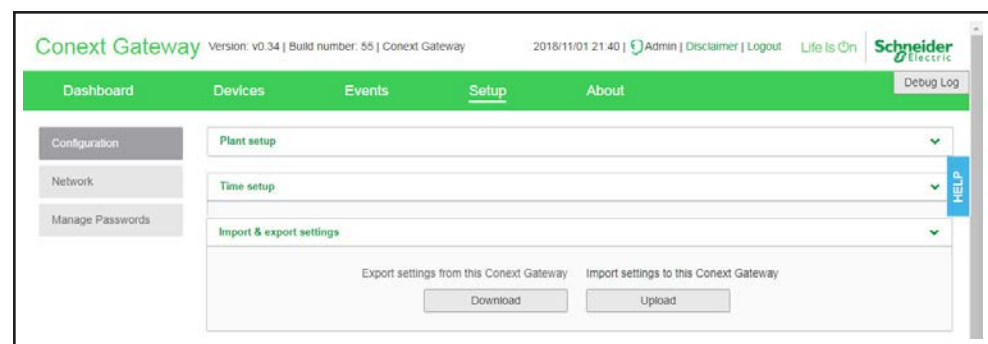
**To export settings:**

1. In the main menu bar, click **Setup > Configuration**.  
The **Configuration** settings appear in the main display area.
2. Click **Import & export settings**.
  - a. Click **Download**. The compressed configuration file *usersettings.zip* will be automatically saved to the **Downloads** folder of the browser.
  - b. If necessary, you may copy this file to an external drive and later import it to a different Conext Gateway device.

**To import settings:**

1. In the main menu bar, click **Setup > Configuration**.  
The **Configuration** settings appear in the main display area.
2. Click **Import & export settings**.
  - a. Click **Upload**.
  - b. Locate the compressed configuration file *usersettings.zip* from a local directory or an external drive.
  - c. Click **Restart now** to finish the importing of the configuration file.



## Units

This setting allows you to change the standard unit of measurement used in solar irradiance, temperature, and wind speed.

Figure 18 Units setup screen

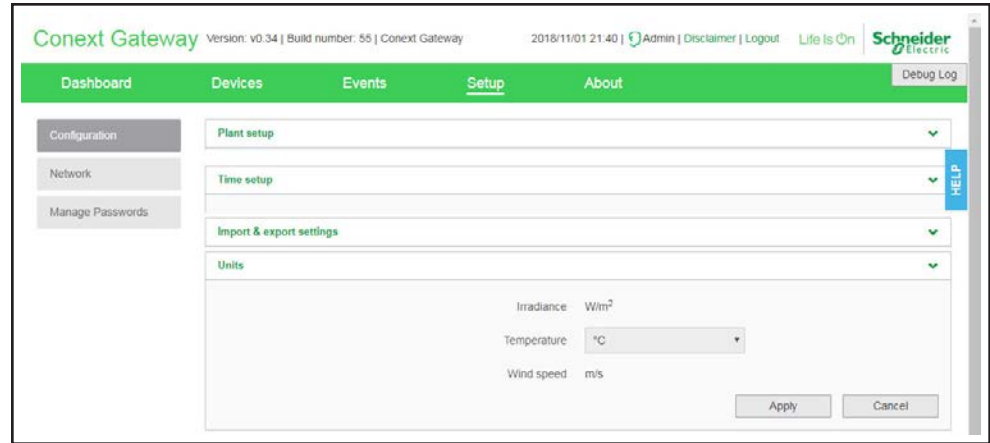

### To change units:

1. In the main menu bar, click **Setup > Configuration**.  
The **Configuration** settings appear in the main display area.
2. Click **Unit**.  
Currently, only **Temperature** can be changed to either celsius or fahrenheit.
3. Save the settings by clicking **Apply** .  
Alternatively, ignore the changes by clicking **Cancel**.

## Modbus Settings

This setting allows you to change the Modbus serial port communication settings.

Figure 19 Modbus settings screen

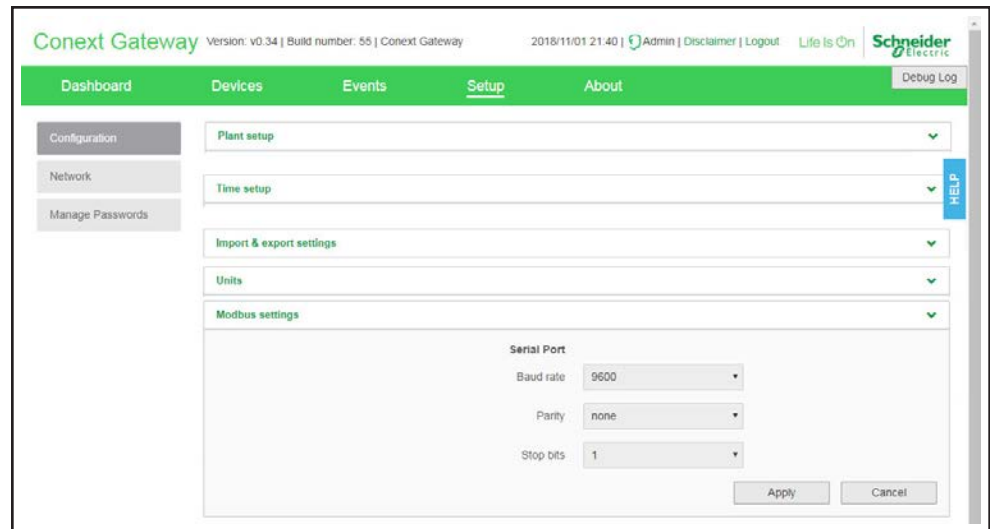

**To change Modbus settings:**

1. In the main menu bar, click **Setup > Configuration**.  
The **Configuration** settings appear in the main display area.
2. Click **Modbus settings**.
  - a. Select the proper **Baud rate**.
  - b. Select the correct **Parity**.
  - c. Select the corresponding **Stop bits**.
3. Save the settings by clicking **Apply** .  
Alternatively, ignore the changes by clicking **Cancel**.

## Restarting the Conext Gateway

You are allowed to to restart, reset the configuration, or return the Conext Gateway to all of the original factory settings remotely from the web user interface or by pressing and holding the Power button according to the settings in *Table 1 on page 14*.

Figure 20 Restart Conext Gateway screen

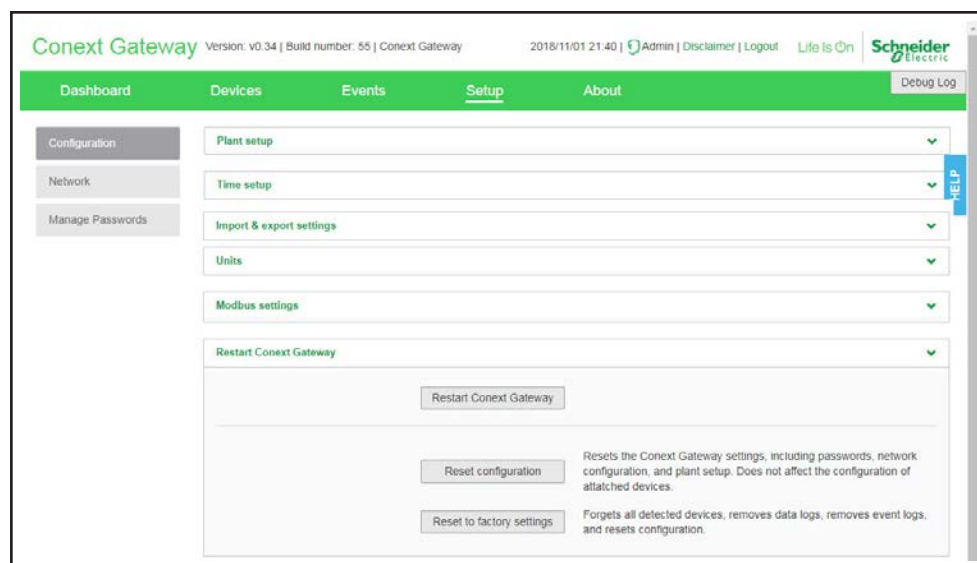
**Choose what to do in the web user interface:**

1. Click **Setup > Configuration > Restart Conext Gateway**.
2. Click any of the action buttons depending on the kind of reset you want to perform.
  - **Restart Conext Gateway** – will execute a soft restart of the Conext Gateway unit. Doing so will temporarily disconnect and put all connected Xanbus devices on Standby.
  - **Reset configuration** – will execute a reset of Conext Gateway settings, including passwords, network configuration, and plant setup. This action does not affect the configuration of connected devices.
  - **Reset to factory settings** – will execute a complete return to factory settings

including forgetting all detected devices, removing data logs, removing event logs, and resetting all configuration.

3. Follow the succeeding instructions.

## Install Package

**To install a Conext Gateway upgrade remotely:**

1. From the Conext Gateway Web Application home page, go to **Setup > Configuration > Install Package**.

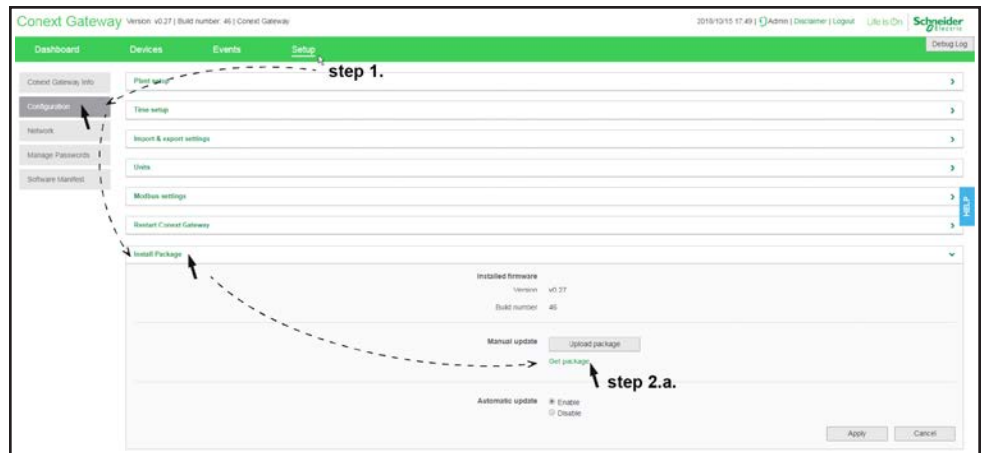

2. Download the firmware package.
  - a. Click **Get package**. This will take you to the Conext Gateway product webpage.
  - b. From the product webpage, go to **DOWNLOADS > Firmware**.
  - c. Search for the latest firmware package from the list and click it to begin downloading.
  - d. Save the `.epkg` file to a local directory.
3. Go back to the Conext Gateway Web Application.
4. Click **Upload package**.
5. Search and select the firmware package (`.epkg` file) you saved in a local directory from the Conext Gateway product webpage.
6. Click **Open** from the Windows dialog. The upgrade begins automatically.
7. As the firmware package is transferred to the Conext Gateway, progress is indicated in percentage, and a message screen indicates when the file transfer has been completed successfully.
8. When prompted, reboot the Conext Gateway. See *Restarting the Conext Gateway* on page 41.

# Changing Device Settings

Before making any changes, familiarize yourself thoroughly with the effects of changing the settings of another device.

## NOTICE

**RISK OF EQUIPMENT DAMAGE**

- Consult the device's Owner's Guide when changing the device's settings.
- Make sure the device connected on the Xanbus or Modbus network is in Standby mode before changing settings.
- Do not change any settings unless you are familiar with the device.

**Failure to follow these instructions can result in equipment damage.**

Figure 21 Sample Device Overview screen - Icons display

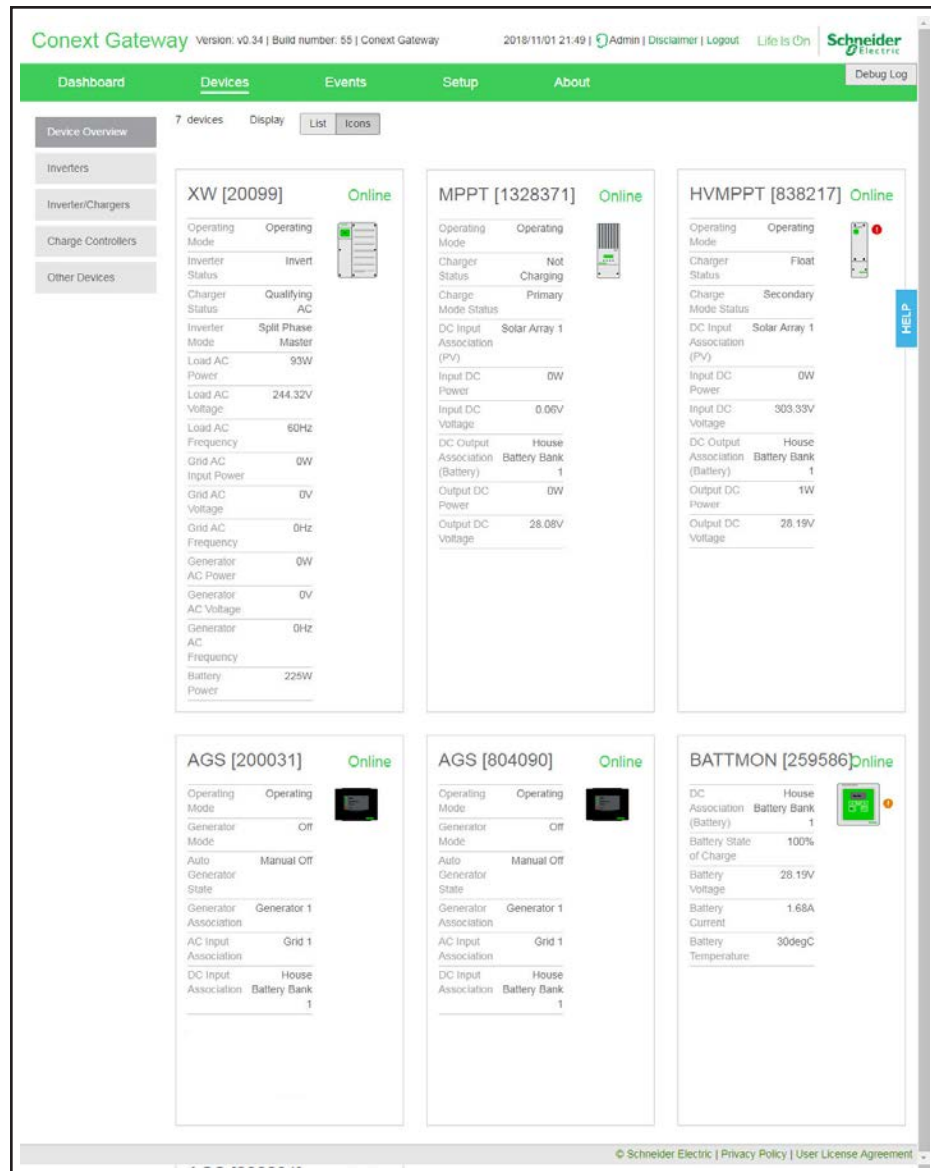

Figure 22 Sample Device Overview screen - List display

Device type	Device Id	Status
XW	20099	Online
GT	835209	Online
HVMPPT	838217	Online
MPPT	1328371	Online
AGS	804090	Online
BATTMON	259586	Online
AGS	200031	Online

### To change a device setting:

1. In the main menu bar, click **Devices**. See *Figure 21* for a sample of the default display of all connected devices.
2. If you want a shorter list of devices, switch to a List display. See *Figure 22*.
3. Put the device in to Standby mode first.
  - a. Click a device you want to put in to Standby mode.
  - b. Click **Configuration > Controls**.  
Note that **Controls** may be called differently such as **AGS Control**.
  - c. Search for the control setting **Operating Mode**.
  - d. Select **Standby**.
  - e. Click **Apply**.
4. Click **Configuration**
5. Choose either **Basic** or **Advanced** settings.
6. Click a device setting category. For example, **Inverter Settings** in the case of an inverter device.
7. Change a specific setting by selecting from a drop down list, toggling a switch, or entering a different value.
8. Click **Apply** to save the changes.
9. Use the **Operating Mode** menu to put the device back into normal operating mode.

## Upgrading Firmware

You can perform firmware upgrades for your Conext Gateway and Xanbus-enabled devices when they are available for download.

There are three upgrade procedures, namely:

- *"Installing Conext Gateway Upgrades From a USB Drive" below*
- *"Installing Conext Gateway Upgrades Remotely" on the facing page*
- *"Upgrading Other Device Firmware" on the facing page*

## Installing Conext Gateway Upgrades From a USB Drive

Follow the procedure below to change the Conext Gateway firmware to an updated version.

### To update the firmware:

1. Using a laptop computer, format a USB drive and open a web browser.
  2. Go to <http://solar.schneider-electric.com> and download the latest Conext Gateway firmware version (contained in a ZIP file).
  3. Navigate to **Products > Battery Based Inverters > Accessories > Conext Gateway**
  4. Click **DOWNLOADS > Firmware > FWYYYYMMDD-Gateway VX.XX BNXXXX (865-0326).ZIP**
  5. Pick the firmware version (V) with a higher number and also a higher build number (BN). The ZIP file is approximately 35 MB.
  6. Extract the .epkg file from the ZIP file into the root directory of the USB drive (supplied with the unit).
  7. To initiate the update to the firmware:
    - a. Insert the USB drive into the port on the Conext Gateway.
    - b. The Conext Gateway will beep once and the LED will blink while the the firmware is copied to the Conext Gateway and the upgrade is performed. This can take 5–10 minutes.
    - c. If the update takes more than 10 minutes, make sure that the .epkg file is copied correctly into the root directory.
- Important:** Once the USB drive is inserted, Do not turn off the Conext Gateway.
8. Once the firmware upgrade is done, the Conext Gateway emits two beeps. and the LED indicator stops blinking.
  9. Remove the USB drive.
  10. Manually reboot the Conext Gateway using the power switch to complete the firmware upgrade process.

## Installing Conext Gateway Upgrades Remotely

For full instructions, see *"Install Package"* on page 42.

## Upgrading Other Device Firmware

It is possible to upgrade a device's firmware through the Conext Gateway web application.

**NOTICE**

**RISK OF EQUIPMENT DAMAGE**

- Consult the device's Owner's Guide when changing the device's settings.
- Make sure the device connected on the Xanbus or Modbus network is in Standby mode before changing settings.
- Do not change any settings unless you are familiar with the device.

**Failure to follow these instructions can result in equipment damage.**

Figure 23 Sample Device Overview screen - List display

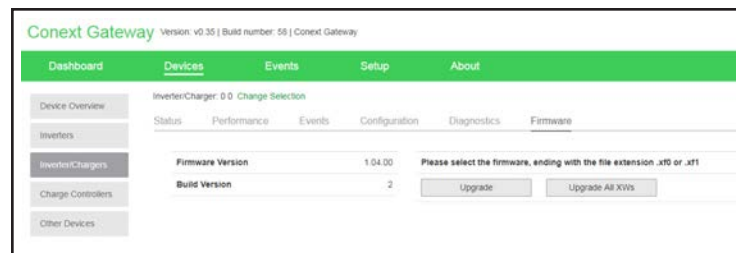

### To obtain the firmware package:

1. From a laptop computer, open a web browser.
2. Go to <http://solar.schneider-electric.com> and download the latest Conext Gateway firmware version (contained in a ZIP file).
3. Navigate to **Products > Battery Based Inverters > Accessories**.
4. Click **DOWNLOADS > Firmware > FWYYYYMMDD-Product NameVX.XX BNXXXX (Product Number).ZIP**.
5. Pick the firmware version (V) with a higher number and also a higher build number (BN). The ZIP file is approximately 6 MB.
6. Extract the .xfo file from the ZIP file into a folder on the local drive.

### To upgrade a device firmware:

1. In the main menu bar, click **Devices**.
2. Put the device in to Standby mode first.
  - a. Click a device you want to put in to Standby mode.
  - b. Click **Configuration > Controls**.  
Note that **Controls** may be called differently such as **AGS Control**.

- c. Search for the control setting **Operating Mode**.
  - d. Select **Standby**.
  - e. Click **Apply**.
3. Click **Firmware** .
  4. Click **Upgrade**.
  5. Follow the step-by-step upgrade instructions.
  6. To upgrade all similar devices in the network, click **Upgrade All**.
  7. Follow the step-by-step upgrade instructions.
  8. Use the **Operating Mode** menu to put the device back into normal operating mode.



# 4 Monitoring







What's in This Chapter?

<b>Monitoring LED Indicators</b> .....	<b>49</b>
Startup .....	49
<b>Monitoring the Power Plant</b> .....	<b>49</b>

## Monitoring LED Indicators

LED indicators allow you to monitor the functioning of the Conext Gateway.

Table 2 LED indicators

Icon	Color	LED	Description
	Green	Power	The Conext Gateway is powered and ready to communicate when on.
	Green	Memory	Device is logging data to internal memory when flashing.
	Green	Cloud	Device is actively transferring data with a communication device/s.
	Green	Xanbus	Device is actively transferring data with a Xanbus device/s.
	Green	Modbus	Device is actively transferring data with a Modbus device/s.
	Red	Event	Devices on the Power system have events or alerts when on.
	Blue	Wi-Fi	Wi-Fi connectivity is established.

### Startup

The Power LED flashes slowly when the Conext Gateway application is loading and flashes quickly during application initialization. The other LEDs illuminate as startup progresses. Once the Conext Gateway is ready, the Power LED turns on (solid). This process takes about two minutes.

## Monitoring the Power Plant

You can view the current state of the power plant by viewing the Conext Gateway dashboard.

With the **Dashboard**, you can view power flow between the connected devices, battery information, and energy production and consumption.

Figure 24 Dashboard

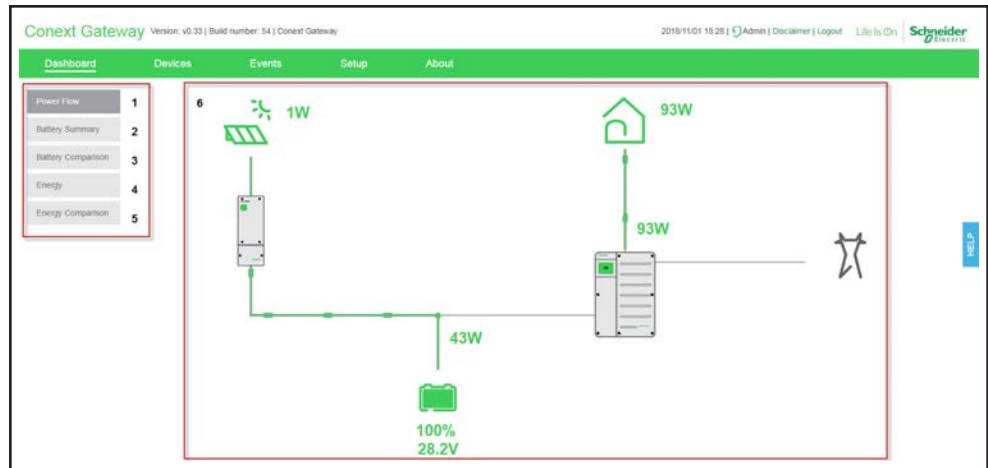

1	<b>Power flow</b> tab – shows an interactive and graphical view of the power plant with its different connected devices.
2	<b>Battery summary</b> tab – shows a historical line graph of four battery metrics such as current, volts, temperature, and state-of-charge (SOC). It shows one battery at a time.
3	<b>Battery comparison</b> tab – shows a historical and comparative line graph of the four battery metrics against all the different batteries.
4	<b>Energy</b> tab – shows a chronological summary of energy that is produced by three sources; solar, grid, and battery. Also shows a chronological summary of energy that is output to four energy consumers; load, grid, battery, and generator.
5	<b>Energy comparison</b> tab – shows a comparative graph between energy input and output.
6	<b>Main display board</b> – shows the different graphical elements of the power plant, the devices, battery, and energy information.

**To view the dashboard:**

1. After successfully logging in, the very first view to show on the main display board is the **Dashboard - Power Flow**.
2. Click each of the tabs on the left to switch to different views.



# 5 Troubleshooting

What's in This Chapter?

**Events** ..... 53

## Events

The events detected and monitored by Conext Gateway vary in type. The types of events are categorized into warnings and detected faults. Warnings are displayed as orange icons with an exclamation point. Detected faults are displayed as red icons with an exclamation point.

When devices detect an event that usually resolves by itself, it is still reported to Conext Gateway and logged. It is logged under **Historical** (see *Figure 26*). However, events that happen repeatedly escalate to a fault or sometimes the device detects a fault, such as a ground fault. When a fault is detected, it is also reported to Conext Gateway and logged. If service intervention is required, it is logged under **Active** (see *Figure 25*). It remains there until service is performed. Also, if user intervention is required, such as remotely resetting a device, the event is logged under **Active** and remains there until the user is able to perform the necessary action.

Figure 25 Active events

Conext Gateway Version: v0.34 | Build number: 55 | Conext Gateway

2018/11/01 21:46 | Admin | Disclaimer | Logout Life Is On Schneider Electric

Dashboard Devices **Events** Setup About Debug Log

Active

Historical

Event Type	Time	Device Type	Device Id	Id	Name	Description
	2018/08/25 08:47:09 +0100	HVMPPT	838217	82	Network Power Supply Fault	The Network Power Supply has failed. Solution:
	Not Available	GT	835209	54	APS Off	PV Voltage is zero, and grid voltage is within limits (240V AC). Solution:

HELP

CSV

© Schneider Electric | Privacy Policy | User License Agreement

Figure 26 Historical events

Conext Gateway Version: v0.34 | Build number: 55 | Conext Gateway

2018/11/01 21:48 | Admin | Disclaimer | Logout Life Is On Schneider Electric

Dashboard Devices **Events** Setup About Debug Log

Active

Historical

Event Type	Time	Device Type	Device Id	Id	Name	Description
	2018/10/30 00:54:39 +0000	HVMPPT	838217	4	Battery Over Temperature Warning	Cause: The battery is too hot. Solution:
	2018/10/25 07:14:23 +0100	HVMPPT	838217	4	Battery Over Temperature Warning	Cause: The battery is too hot. Solution:
	2018/10/15 21:34:48 +0100	HVMPPT	838217	4	Battery Over Temperature Warning	Cause: The battery is too hot. Solution:
	2018/10/15 08:05:59 +0100	HVMPPT	838217	4	Battery Over Temperature Warning	Cause: The battery is too hot. Solution:
	2018/10/03 02:03:53 +0100	HVMPPT	838217	4	Battery Over Temperature Warning	Cause: The battery is too hot. Solution:
	2018/10/02 19:14:09 +0100	HVMPPT	838217	4	Battery Over Temperature Warning	Cause: The battery is too hot. Solution:
	2018/10/01 14:57:11 +0100	HVMPPT	838217	4	Battery Over Temperature Warning	Cause: The battery is too hot. Solution:
	2018/09/28 18:48:48 +0100	HVMPPT	838217	4	Battery Over Temperature Warning	Cause: The battery is too hot. Solution:
	2018/09/28 03:46:12 +0100	MPPT	1328371	71	DC Over-current shutdown	Cause: DC output current is too high. Solution:
	2018/09/28 03:46:12 +0100	HVMPPT	838217	71	DC Over-current shutdown	Cause: DC output current is too high. Solution:

HELP

First Previous **1** 2 3 4 5 6 7 8 9 10 Next Last

CSV

© Schneider Electric | Privacy Policy | User License Agreement

**To view Events:**

1. In the main menu bar, click **Events**.  
The **Active** events are displayed first in the main display board.
2. Click **Historical** to view events that have been logged and/or resolved.
3. To download a copy of the events, click the **CSV** icon on the lower right hand corner of the main display board.



## 6 Specifications

### What's in This Chapter?

<b>Electrical Specifications</b> .....	<b>57</b>
<b>Physical Specifications</b> .....	<b>57</b>
<b>Features</b> .....	<b>58</b>
<b>Regulatory</b> .....	<b>58</b>
FCC Regulatory Compliance .....	58
ISED Regulatory Compliance .....	59
Simplified EU Declaration of Conformity .....	60
<b>Schneider Electric Products that Work with the Conext Gateway</b> .....	<b>60</b>
<b>Dimensions</b> .....	<b>61</b>

## Electrical Specifications

**NOTE:** Specifications subject to change without prior notice.

<b>NOTICE</b>
<p><b>EQUIPMENT DAMAGE</b></p> <p>Do not power the unit without first installing the supplied antennas.</p> <p><b>Failure to follow these instructions can result in equipment damage.</b></p>

Power Consumption	2 W average / 10 W peak
AC/DC adapter (supplied)	<p>Input: 100-240 V AC, 50-60 Hz, 0.48 A, Output: 12 V DC, 1.6 A, 5.5 mm outer, 2.1 mm center-positive jack.</p> <p><b>NOTE:</b> Required when used with the Conext SW.</p>
Xanbus	When connected to Conext XW Pro/XW+ or MPPT 80 600 providing network power
9–24V on 26-pin connector	9–24 V DC, 1 A max input only through pins 1 and 2 Accepts 16–24 AWG pin wire size.
Operation Frequency	<p>2412–2472 MHz (Europe) 2414–2462 MHz (N. America)</p>
Max. radio frequency power transmitted	17.06 dBm (E.I.R.P., Declaration for EU)

## Physical Specifications

**NOTE:** Specifications subject to change without prior notice.

Weight (device only)	337 g (0.74 lb)
Dimensions (device only) (W × H × D)	137 x 131 x 41 mm (5.4 × 5.2 × 1.6 inches)
Shipping package dimensions	158 × 158 × 188 mm (6.2 × 6.2 × 7.4 inches)
Shipping package weight	920 g (2 lbs)
Housing/Mounting system	ABS Plastic / 35-mm DIN rail clip
IP rating / Mounting Location	IP 20, NEMA 1, Indoor only
Status Display	7 x LEDs
Temperature	<p>Operating: -4 to 122 °F (-20 to 50 °C) Storage: -40 to 185 °F (-40 to 85 °C) Maximum case temperature: 140 °F (60 °C)</p>
Humidity	Operating: < 95%, non-condensing Storage: < 95%

## Features

**NOTE:** Specifications subject to change without prior notice.

Programmable dry contact relay	Screw 3-terminal, 16-24 AWG, NC-Com-NO, Form: Class 2, 24 V DC, 4 A max SELV input only
Web-base user interface	Internet Browser
Remote firmware upgrades	Yes (Conext Gateway and connected Xanbus devices)
Custom Data logger	Yes (requires Micro-SD card)
Micro-SD card (supplied)	8GB

## Regulatory

**NOTE:** Specifications subject to change without prior notice.

EMC immunity	EN61000-6-1 EN 301 489-1, -17	EN 55035
EMC emissions	EN61000-6-3 EN 301 489-1, -17 FCC part 15B	EN 55032 ICES-003
Substances / environmental	RoHS	
FCC ID	Contains 2AODL-CONEXTGTWY	
IC ID	Contains 24209-CONEXTGTWY	
Model number	865-0329	

## FCC Regulatory Compliance

This device complies with Part 15 of the FCC Rules. Operation is subject to the following two conditions: (1) this device may not cause harmful interference, and (2) this device must accept any interference received, including interference that may cause undesired operation.

**Note:** This equipment has been tested and found to comply with the limits for a Class B digital device, pursuant to Part 15 of the FCC Rules. These limits are designed to provide reasonable protection against harmful interference in a residential installation. This equipment generates, uses and can radiate radio frequency energy and, if not installed and used in accordance with the instructions, may cause harmful interference to radio communications.

However, there is no guarantee that interference will not occur in a particular installation.

If this equipment does cause harmful interference to radio or television reception, which can be determined by turning the equipment off and on, the user is encouraged to try to correct the interference by one or more of the following measures:

- Reorient or relocate the receiving antenna.
- Increase the separation between the equipment and receiver.

- Connect the equipment into an outlet on a circuit different from that to which the receiver is connected.
- Consult the dealer or an experienced radio/TV technician for help.

**Note:** changes or modifications not expressly approved by the party responsible for compliance could void the user's authority to operate the equipment.

## RF Exposure Compliance

This equipment complies with FCC radiation exposure limits set forth for an uncontrolled environment. This equipment should be installed and operated with minimum distance 20 cm between the radiator and your body. This transmitter must not be co-located or operating in conjunction with any other antenna or transmitter.

## Supplier's Declaration of Conformity

### 47 CFR § 2.1077 Compliance Information

Unique Identifier:

Trade Name: Conext Gateway

Model No.: 865-0329

### Responsible Party – U.S. Contact Information

Schneider Electric Solar Inverters USA, Inc.

250 S. Vasco Road, Livermore, CA 94551

<https://solar.schneider-electric.com/>

### FCC Compliance Statement

This device complies with Part 15 of the FCC Rules. Operation is subject to the following two conditions: (1) This device may not cause harmful interference, and (2) this device must accept any interference received, including interference that may cause undesired operation.

## ISED Regulatory Compliance

This device contains licence-exempt transmitter(s) that comply with Innovation, Science and Economic Development Canada's licence-exempt RSS(s).

Operation is subject to the following two conditions:

1. This device may not cause interference.
2. This device must accept any interference, including interference that may cause undesired operation of the device.

L'émetteur exempt de licence contenu dans le présent appareil est conforme aux CNR d'Innovation, Sciences et Développement économique Canada applicables aux appareils radio exempts de licence. L'exploitation est autorisée aux deux conditions suivantes :

1. L'appareil ne doit pas produire de brouillage;
2. L'appareil doit accepter tout brouillage radioélectrique subi, même si le brouillage est susceptible d'en compromettre le fonctionnement.

This equipment complies with IC RSS-102 radiation exposure limits set forth for an uncontrolled environment. This transmitter must not be co-located or operating in conjunction with any other antenna or transmitter. This equipment should be installed and operated with minimum distance 20 cm between the radiator and your body.

Cet équipement est conforme aux limites d'exposition aux radiations IC CNR-102 établies pour un environnement non contrôlé. Cet émetteur ne doit pas être situé ou fonctionner conjointement avec une autre antenne ou un autre émetteur. Cet équipement doit être installé et utilisé avec une distance minimale de 20 cm entre le radiateur et votre corps.

CAN ICES-3 (B)/NMB-3(B)

## Simplified EU Declaration of Conformity

Hereby, Schneider Electric declares that the radio equipment type 865-0329 is in compliance with Directive 2014/53/EU. The full text of the EU declaration of conformity is available at the following internet address:

<https://solar.schneider-electric.com/>

## Schneider Electric Products that Work with the Conext Gateway

- Conext XWPro Inverter / Charger:
  - Conext XWPro 6848 NA Product No. 865-6848-21
- Conext XW+ Inverter / Chargers:
  - Conext XW+ 7048 E Product No. 865-7048-61
  - Conext XW+ 8548 E Product No. 865-8548-61
  - Conext XW+ 5548 NA Product No. 865-5548-01
  - Conext XW+ 6848 NA Product No. 865-6848-01
- Conext SW Inverter / Chargers:
  - SW 2524 120/240 Product No. 865-2524
  - SW 4024 120/240 Product No. 865-4024
  - SW 2524 230/240 Product No. 865-2524-61
  - SW 4024 230/240 Product No. 865-4024-61
- Conext MPPT 60 150 Solar Charge Controller: Product No. 865-1030-1
- Conext MPPT 80 600 Solar Charge Controller: Product No. 865-1032
- Conext System Control Panel (SCP): Product No. 865-1050-01
- Conext Automatic Generator Start (AGS): Product No. 865-1060-01
- Conext Battery Monitor: Product No. 865-1080-01

# Dimensions

**NOTE:** Specifications subject to change without prior notice.

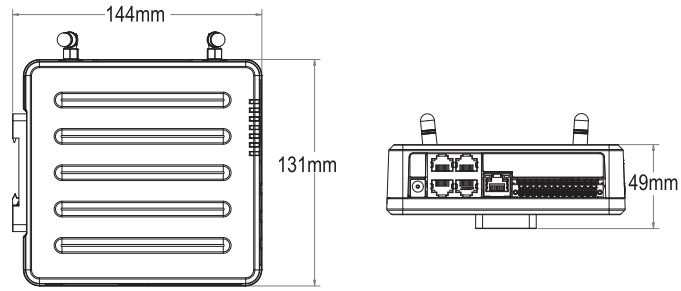

# A Using Chrome to Install the Conext GatewaySecurity Certificate

What's in This Chapter?

**Installing the Conext Gateway Security Certificate ..... 63**

## Installing the Conext Gateway Security Certificate

These instructions explain how to download the web security certificate from the Conext Gateway and install it on your PC using Chrome on Windows 10.

### To export the security certificate:

1. Open the Chrome developer tools using one of the following methods:
  - a. Press F12.
  - b. Click the three dots in the top right-hand corner of the window, then click **More Tools** and then **Developer Tools**.
  - c. Use the keyboard command Ctrl+Shift+I.
2. Navigate to the **Security** tab in **Developer Tools**.
3. Click **View Certificate**.

Figure 27 Security tab

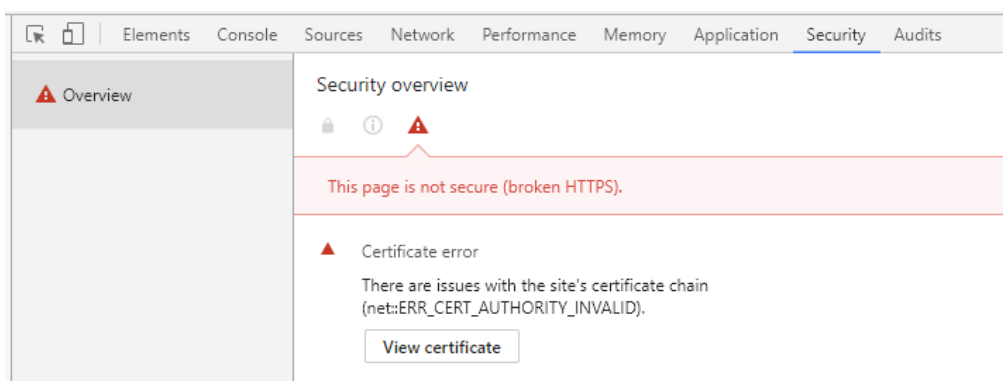



4. Click the **Certification Path** tab.

Figure 28 Certificate path tab

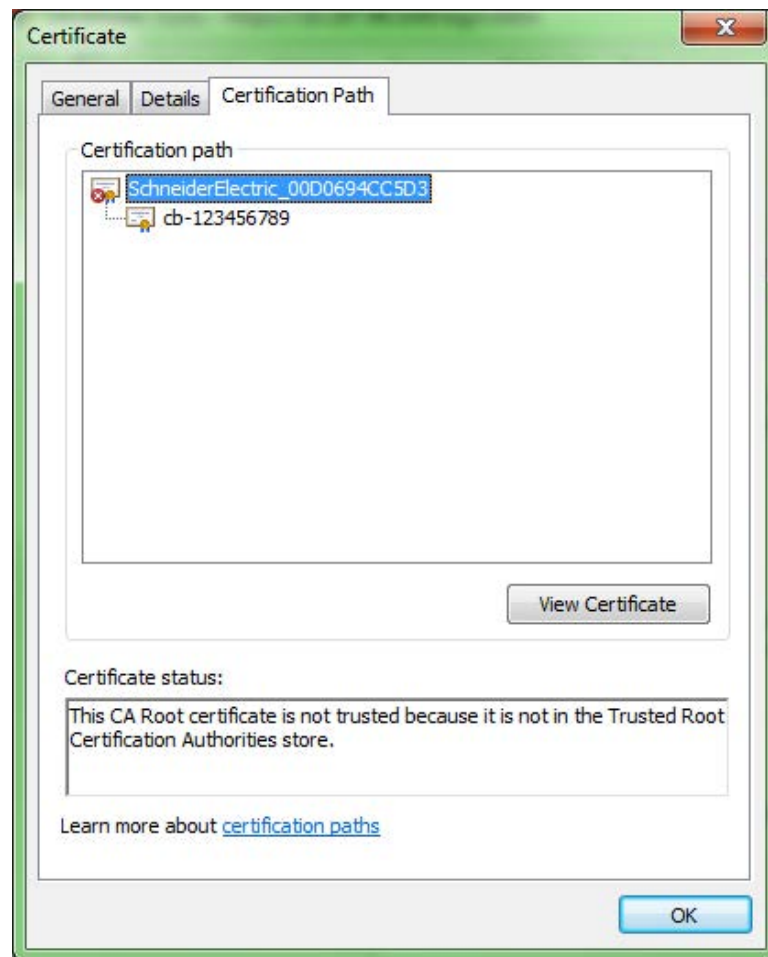

5. Click **View Certificate**.

6. Confirm that the hex string following the underscore in the Issued By: statement matches the MAC Address of your Conext Gateway.

Figure 29 View certificate

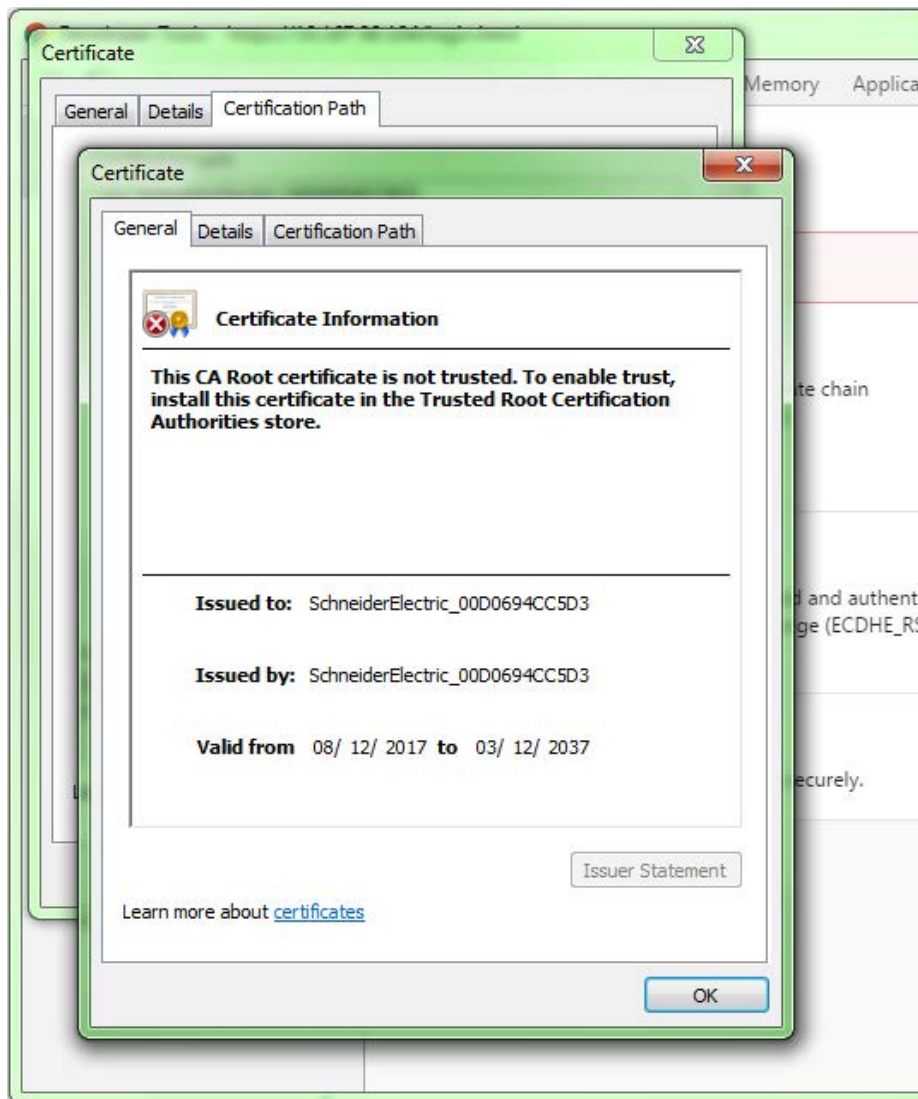

7. Click the **Details** tab.

Figure 30 Details tab

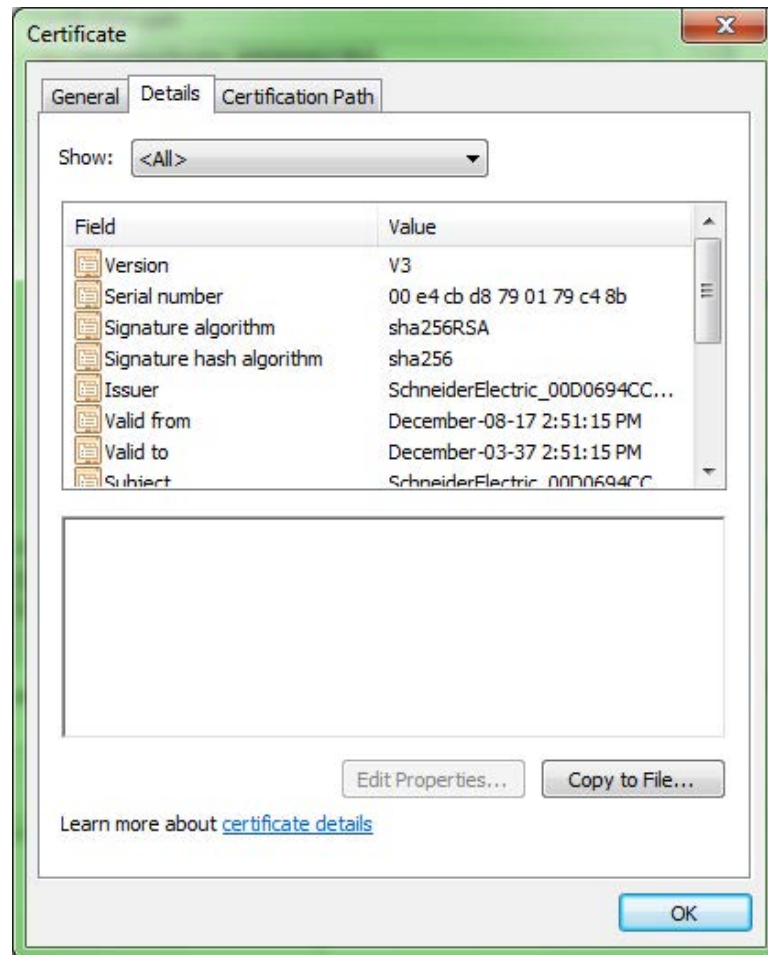

- 8. Click **Copy to File...** to open the Certificate Export Wizard and then click **Next**.

Figure 31 Certificate Export Wizard



9. Click the radio button beside **DER encoded binary** and then click **Next**.

Figure 32 Export settings

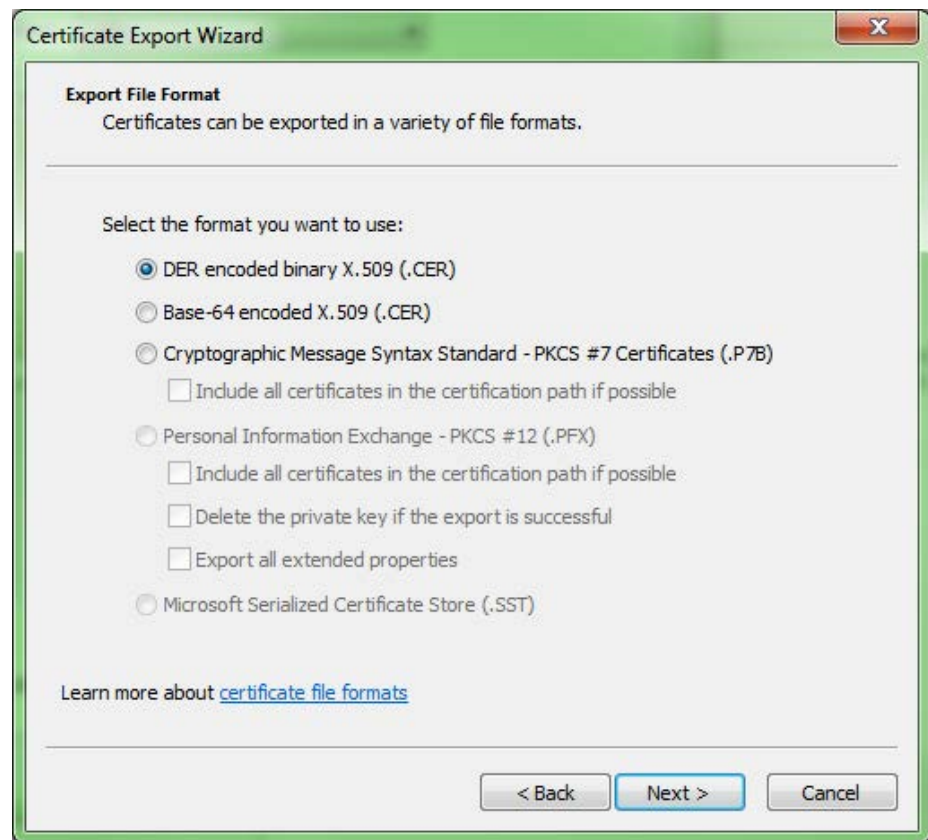

10. Click **Finish** to save it to your file system (remember where it has saved).

Figure 33 Confirmation

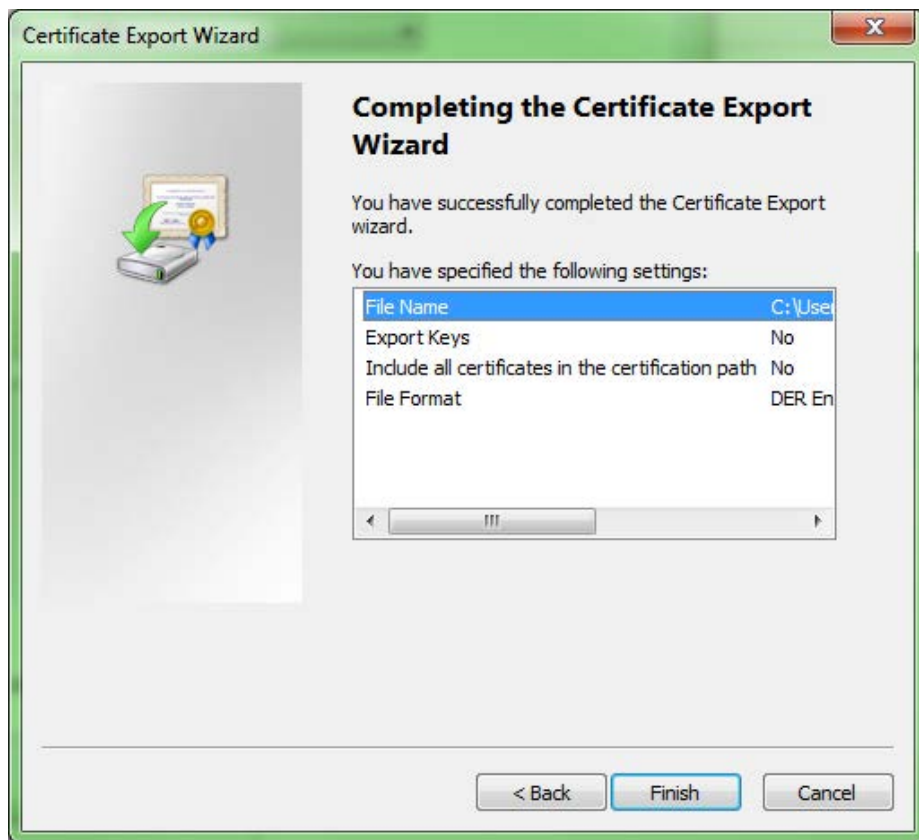

**To import the security certificate:**

1. Using the windows file browser, go to the location where you saved the certificate file, and double-click the certificate file.
2. Click **Install Certificate** and then click **Next**.

*Figure 34 Certificate Import Wizard*

3. Click the radio button beside **Place all certificates in the following store** and then click **Browse**.

Figure 35 Import settings

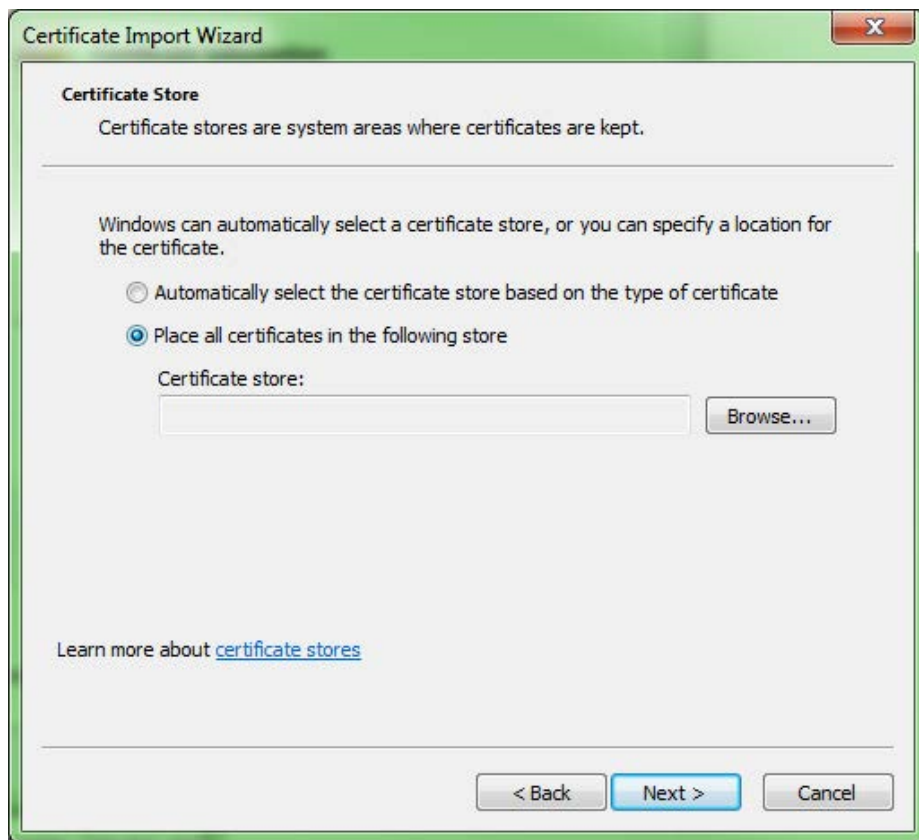



4. Click **Trusted Root Certificate Authorities** and then click **OK**.

Figure 36 Select certificate store



The Certificate Import Wizard should look like this:

Figure 37 Import settings confirmation

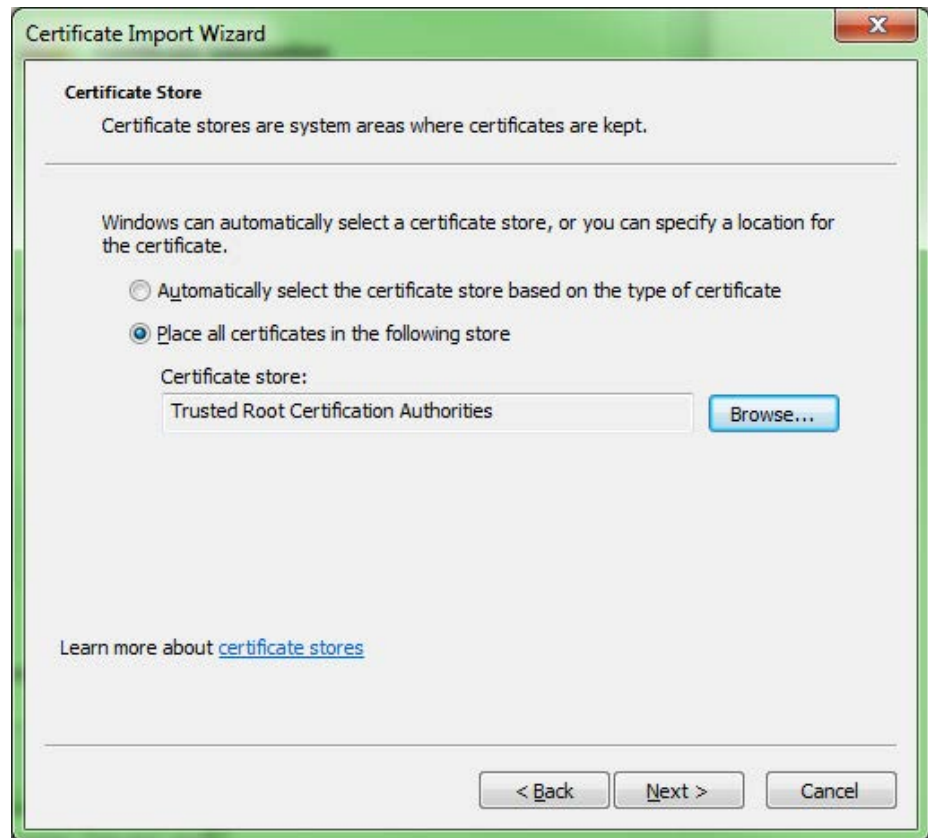

5. Click **Next** and then click **Finish**.
6. Click **Yes** to the security warning, and then click **OK** when the Certificate Import Wizard confirms the import was successful.
7. Restart your browser and confirm the word Secure is now beside the Conext Gateway web user interface address.

Figure 38 Website secure

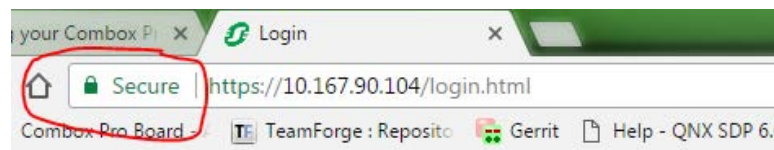

## **Schneider Electric**

As standards, specifications, and designs change from time to time, please ask for confirmation of the information given in this publication.

For other country details please contact your local Schneider Electric Sales Representative or visit the Schneider Electric Solar Business website at: <http://solar.schneider-electric.com/>

© 2019 Schneider Electric. All Rights Reserved.