

# Conext™ SW Inverter/Charger

Conext SW 2524 230 (865-2524-61)

Conext SW 4024 230 (865-4024-61)

Conext SW 4048 230 (865-4048-61)

## Owner's Guide

975-0636-01-01 Rev D

1-2015

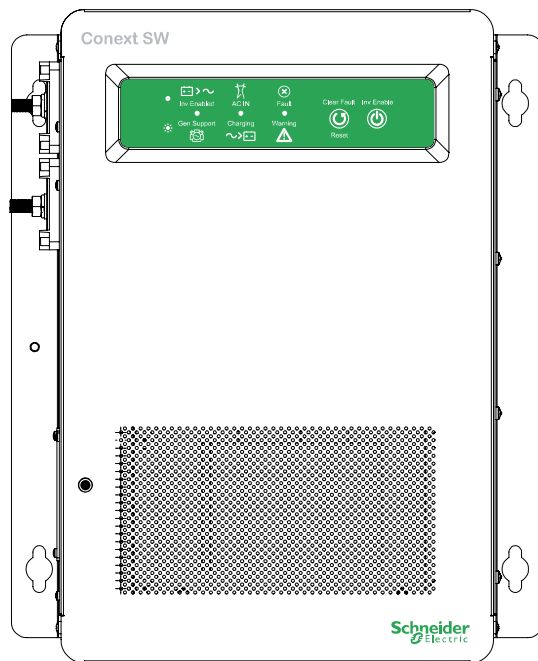

**xanbus™**  
E N A B L E D



# Conext SW Inverter Charger

Conext SW 2524 230 (865-2524-61)

Conext SW 4024 230 (865-4024-61)

Conext SW 4048 230 (865-4048-61)

Owner's Guide

Copyright © 2013-2015 Schneider Electric. All Rights Reserved. All trademarks are owned by Schneider Electric Industries SAS or its affiliated companies.

**Exclusion for Documentation**

UNLESS SPECIFICALLY AGREED TO IN WRITING, SELLER

(A) MAKES NO WARRANTY AS TO THE ACCURACY, SUFFICIENCY OR SUITABILITY OF ANY TECHNICAL OR OTHER INFORMATION PROVIDED IN ITS MANUALS OR OTHER DOCUMENTATION;

(B) ASSUMES NO RESPONSIBILITY OR LIABILITY FOR LOSSES, DAMAGES, COSTS OR EXPENSES, WHETHER SPECIAL, DIRECT, INDIRECT, CONSEQUENTIAL OR INCIDENTAL, WHICH MIGHT ARISE OUT OF THE USE OF SUCH INFORMATION. THE USE OF ANY SUCH INFORMATION WILL BE ENTIRELY AT THE USER'S RISK; AND

(C) REMINDS YOU THAT IF THIS MANUAL IS IN ANY LANGUAGE OTHER THAN ENGLISH, ALTHOUGH STEPS HAVE BEEN TAKEN TO MAINTAIN THE ACCURACY OF THE TRANSLATION, THE ACCURACY CANNOT BE GUARANTEED. APPROVED CONTENT IS CONTAINED WITH THE ENGLISH LANGUAGE VERSION WHICH IS POSTED AT SOLAR.SCHNEIDER-ELECTRIC.COM.

**Document Number:** 975-0636-01-01      **Revision:** Rev D      **Date:** 1-2015

**Product Part Numbers:** 865-2524-61, 865-4024-61, 865-4048-61

**Contact Information**      solar.schneider-electric.com

Please contact your local Schneider Electric Sales Representative or visit our website at:  
<http://solar.schneider-electric.com/tech-support/>

**Information About Your System**

As soon as you open your product, record the following information and be sure to keep your proof of purchase.

Serial Number      \_\_\_\_\_

Product Number      \_\_\_\_\_

Purchased From      \_\_\_\_\_

Purchase Date      \_\_\_\_\_

# About This Guide

## Purpose

The purpose of this Owner's Guide is to provide explanations and procedures for operating, troubleshooting, and maintaining the Conext SW Inverter/Charger.

## Scope

The Guide provides safety guidelines, as well as information about operating and troubleshooting the unit. It does not provide details about particular brands of batteries. You need to consult individual battery manufacturers for this information.

## Audience

The Guide is intended for users and operators of the Conext SW Inverter/Charger.

## Organization

This Guide is organized into the following chapters.

Chapter 1, "Introduction" covers material list, key features, and basic protection features.

Chapter 2, "Components and Mechanical Features" provides detailed information on system components and the product's main features.















Chapter 3, "Operation" provides operational instructions from the Front Panel including operation using the System Control Panel (SCP).

Chapter 4, "Configuration via SCP" provides instructions to change inverter and charger settings using the System Control Panel (SCP).

Chapter 5, "Troubleshooting" covers normal troubleshooting guidelines that also includes fault detection and warning codes and how to interpret them.

Chapter 6, "Specifications" covers product specifications.

## Abbreviations, Acronyms, and Symbols

<b>AC</b>	Alternating Current	<b>LED</b>	Light Emitting Diode
<b>AGS</b>	Automatic Generator Start	<b>SCP</b>	System Control Panel
<b>BOS</b>	Balance of System	<b>SW</b>	Sine Wave
<b>DC</b>	Direct Current	<b>VAC</b>	Volts, Alternating Current
<b>PPE</b>	Personal Protective Equipment	<b>VDC</b>	Volts, Direct Current
<b>PV</b>	Photovoltaic	<b>IP20</b>	Ingress protection rating
	Reference to see guide (or manual) for more information		Earth
	AC		DC
	Denotes a steady LED		Denotes a flashing LED
	<b>Inv Enabled</b> – see “Front Panel LEDs” on page 3–4 for definition.		<b>Gen Support</b> – see “Front Panel LEDs” on page 3–4 for definition.
	<b>AC IN</b> – see “Front Panel LEDs” on page 3–4 for definition.		<b>Charging</b> – see “Front Panel LEDs” on page 3–4 for definition.
	<b>Fault</b> – see “Front Panel LEDs” on page 3–4 for definition.		<b>Warning</b> – see “Front Panel LEDs” on page 3–4 for definition.
	<b>Clear Fault   Reset</b> – see “Conext SW Front and Side Panels” on page 2–4 for definition.		<b>Inv Enable</b> – see “Conext SW Front and Side Panels” on page 2–4 for definition.

## Related Information

You can find more information about Schneider Electric as well as its products and services at [solar.schneider-electric.com](http://solar.schneider-electric.com).

# Important Safety Instructions

## READ AND SAVE THESE INSTRUCTIONS - DO NOT DISCARD

This guide contains important safety instructions for the Conext SW Inverter/Charger that must be followed during operation and troubleshooting. **Read and keep this Owner's Guide for future reference.**

Read these instructions carefully and look at the equipment to become familiar with the device before trying to install, operate, service or maintain it. The following special messages may appear throughout this bulletin or on the equipment to warn of potential hazards or to call attention to information that clarifies or simplifies a procedure.



The addition of either symbol to a "Danger" or "Warning" safety label indicates that an electrical hazard exists which will result in personal injury if the instructions are not followed.



This is the safety alert symbol. It is used to alert you to potential personal injury hazards. Obey all safety messages that follow this symbol to avoid possible injury or death.

### **DANGER**

DANGER indicates an imminently hazardous situation, which, if not avoided, will result in death or serious injury.

### **WARNING**

WARNING indicates a potentially hazardous situation, which, if not avoided, can result in death or serious injury.

### **CAUTION**

CAUTION indicates a potentially hazardous situation, which, if not avoided, can result in moderate or minor injury.

### **NOTICE**

NOTICE indicates a potentially hazardous situation, which, if not avoided, can result in equipment damage.

## Safety Information

### DANGER

#### **ELECTRICAL SHOCK AND FIRE HAZARD**

Installation must be done by qualified personnel to ensure compliance with all applicable installation and electrical codes and regulations. Instructions for installing the Conext SW are provided in a separate installation guide for use by qualified installers only.

**Failure to follow these instructions will result in death or serious injury.**

### DANGER

#### **ELECTRICAL SHOCK AND FIRE HAZARD**

- Read all instructions, cautionary markings, and all other appropriate sections of this guide before operating, troubleshooting, and performing maintenance on the Conext SW.
- Exercise extreme caution at all times to prevent accidents.
- Do not cover or obstruct ventilation openings.
- Do not mount in a zero-clearance compartment. Overheating may result.
- Do not open nor disassemble the inverter/charger. There are no user-serviceable parts inside.
- Do not expose to rain or spray.
- Disconnect and lockout all AC and DC sources before servicing. Servicing includes maintenance or cleaning or working on any circuits connected to the inverter/charger. See following note

**Failure to follow these instructions will result in death or serious injury.**

**NOTE:** Turning off inverter mode using the Inv Enable switch on the front panel, disabling the inverter and charger functions using the SCP, and putting the unit in Standby mode will not reduce an electrical shock hazard.



**⚠ DANGER****ELECTRIC SHOCK HAZARD**

- For indoor use only. This inverter/charger is designed for off-grid, solar, backup, and hybrid applications. See the installation guide for information.
- Do not operate the inverter/charger if it has been damaged in any way.
- Do not operate the inverter/charger with damaged or substandard wiring. Wiring must be done by qualified personnel to ensure compliance with all applicable installation codes and regulations.

**Failure to follow these instructions will result in death or serious injury.**

**⚠ WARNING****EXPLOSION AND FIRE HAZARD**

- Charge properly rated lead-acid (GEL, AGM, Flooded, or lead-calcium) rechargeable batteries because other battery types may explode.
- When using Lithium-Ion batteries, ensure that the battery pack being used includes a Battery Management System (BMS) with safety controls.
- Do not work in the vicinity of lead-acid batteries. Batteries generate explosive gases during normal operation. See note #1.
- Do not install and/or operate in compartments containing flammable materials or in locations that require ignition-protected equipment. See notes #2 and #3.

**Failure to follow these instructions can result in death or serious injury.**

**NOTES:**

1. Follow these instructions and those published by the battery manufacturer and the manufacturer of any equipment you intend to use in the vicinity of the battery. Review cautionary markings on these products.
2. This inverter/charger contains components which tend to produce arcs or sparks.
3. Locations include any space containing gasoline-powered machinery like a generator, fuel tanks, as well as joints, fittings, or other connections between components of the fuel system.

**⚠ CAUTION****FIRE AND BURN HAZARD**

Do not cover or obstruct the air intake vent openings and/or install in a zero-clearance compartment.

**Failure to follow these instructions can result in moderate or minor injury.**

**⚠ CAUTION**

**PHYSICAL INJURY HAZARD**

This Conext SW Inverter/Charger is not intended for use by persons (including children) with reduced physical, sensory, or mental capabilities or lack of experience and knowledge, unless they have been given supervision or instruction concerning use of the appliance by a person responsible for their safety. Children should be supervised to ensure that they do not play with the appliance.

**Failure to follow these instructions can result in moderate or minor injury.**

## Precautions When Working With Batteries

---

**IMPORTANT:** Battery work and maintenance must be done by qualified personnel knowledgeable about batteries to ensure compliance with battery handling and maintenance safety precautions.

---

**⚠ WARNING**

**BURN AND FIRE HAZARD**

- Always wear proper, non-absorbent gloves, complete eye protection, and clothing protection.
- Batteries have high short-circuit current.
- Do not lay tools or metal objects on top of batteries.
- Disconnect charging source before disconnecting battery terminals.
- Remove all personal metal items, like rings, bracelets, and watches when working with batteries.
- Never smoke or allow a spark or flame near batteries.
- Batteries can produce a short circuit current high enough to weld a ring or metal bracelet or the like to the battery terminal, causing a severe burn.

**Failure to follow these instructions can result in death or serious injury.**

**⚠ WARNING****CHEMICAL, BURN, AND EXPLOSION HAZARD**

- Do not open or use a battery which is cracked or otherwise damaged. Battery electrolyte is toxic and highly corrosive.
- Never place the Conext SW Inverter/Charger unit in the same compartment as batteries due to an explosive hazard.
- Make sure the area around the battery is well ventilated.
- Make sure the voltage of the batteries matches the output voltage of the inverter/charger.
- Never allow battery acid to drip when reading specific gravity or filling battery.

**Failure to follow these instructions can result in death or serious injury.**

**⚠ WARNING****LIMITATIONS ON USE**

Do not use in connection with life support systems or other medical equipment.

**Failure to follow these instructions can result in death or serious injury.**

***NOTICE*****RISK OF INVERTER/CHARGER DAMAGE**

Never place the Conext SW Inverter/Charger unit directly above batteries; gases from a battery will corrode and damage the inverter/charger.

**Failure to follow these instructions can result in damage to equipment.**

***NOTICE*****RISK OF BATTERY DAMAGE**

Study and follow all of the battery manufacturer's specific precautions, such as removing or not removing cell caps while charging, whether equalization is acceptable for your battery, and recommended rates of charge.

**Failure to follow these instructions can result in damage to equipment.**



# Contents

## Important Safety Instructions

Safety Information .....	vi
Precautions When Working With Batteries .....	viii

## 1 Introduction

Materials List .....	1-2
Key Features .....	1-3
Key Features Explained .....	1-4
Basic Protection Features .....	1-5
Grid-interactive and Other Features .....	1-6
Load Shaving .....	1-6
AC Support .....	1-7
AC Support Mode using SOC .....	1-8
Enhanced AC Support .....	1-8
Regular AC Support without Xanbus devices .....	1-10
Grid-Interactive Delay Feature .....	1-10
AC Coupling .....	1-11
Storing the State of the Inverter Mode .....	1-12
NoLoadVD .....	1-12
Low Battery Cut Out Hysteresis .....	1-13
LBCO Delay .....	1-13
Lithium Ion Battery Type .....	1-13

## 2 Components and Mechanical Features

System Components .....	2-2
Xanbus System .....	2-2
Xanbus-enabled Products and Other Accessories .....	2-3
Conext SW Inverter/Charger Mechanical Features .....	2-4
Conext SW Front and Side Panels .....	2-4
Front Panel Buttons and Status LEDs .....	2-5
Conext SW AC/DC/Ports Side Panel .....	2-6

## 3 Operation

Start Up Behavior .....	3-2
Inverter Operation Using the Front Panel .....	3-3
Operating Limits for Inverter Operation .....	3-5
Operating Limits for Charger Operation .....	3-6
Inverter/Charger Operation using the System Control Panel (SCP) .....	3-7
SCP Features .....	3-8
Using the Standby Button .....	3-9

---

SCP Navigation	3-9
Startup Screen	3-9
Viewing the SCP Home Screens	3-10
Viewing Other Screens	3-13
Changing Operational Settings	3-15
<b>4 Configuration via SCP</b>	
Viewing the Firmware Revision Number	4-2
Setting the Time and Date	4-3
Viewing the Basic and Advanced Settings Menus	4-4
Configuring Basic Settings	4-7
Configuring Advanced Settings	4-9
Inverter Settings Menu	4-9
Using the Low Battery Cut Out and LBCO Delay Settings	4-11
Low Battery Cut Out Hysteresis	4-11
Using Search Mode	4-11
Using Inverter Block	4-12
Charger Settings Menu	4-13
Battery Charger Functions	4-15
Multi-Stage Charging Process	4-15
Equalize-Charging the Batteries	4-17
Using Charger Block	4-18
Custom Battery Settings Menu	4-19
LithiumIon Battery Settings Menu	4-20
AC Settings	4-22
AC Support Settings	4-23
AC Support Mode Setting	4-25
Load Shaving Setting	4-26
Enhanced AC Support Setting	4-28
Multi Unit Config Menu	4-29
Setting the Device Name	4-30
Setting the Device Number	4-31
Restoring Factory Default Settings	4-32
Advanced Features Menu	4-33
EuroFreq Feature	4-33
Configuration Sheet	4-35
<b>5 Troubleshooting</b>	
General Troubleshooting Guidelines	5-2
Inverter Applications	5-3
View Device Info Logs	5-4
Troubleshooting the Conext SW via the SCP	5-5
Fault Detection Types	5-5
Warning Types	5-6

**6 Specifications**

Inverter Specifications----- 6-2  
Charger Specifications ----- 6-3  
AC Transfer Specifications ----- 6-4  
Physical Specifications ----- 6-4  
Environmental Specifications----- 6-5  
Regulatory ----- 6-6





# Figures

Figure 1-1	Materials List	1-2
Figure 1-2	Load Shaving in Action	1-6
Figure 1-3	AC Support Mode using SOC	1-8
Figure 1-4	Enhanced AC Support	1-8
Figure 1-5	Enhanced AC Support Charge Cycle	1-9
Figure 1-6	Regular AC Support without Xanbus Devices	1-10
Figure 1-7	Load Shaving 2-Hour Delay Example	1-11
Figure 2-1	Xanbus System Components	2-2
Figure 2-2	Conext SW Front and Side Panels	2-4
Figure 2-3	Front Panel Buttons and Status LEDs	2-5
Figure 2-4	AC and DC Terminals, Network and Communication Ports Panel	2-6
Figure 3-1	Startup Screen	3-9
Figure 3-2	SCP Top Level Screens	3-10
Figure 3-3	System Status Screen	3-11
Figure 3-4	Conext SW Home Screen	3-11
Figure 3-5	Selecting a Device Setup Menu	3-13
Figure 3-6	Viewing the Meters Screen	3-14
Figure 3-7	Navigate To Conext SW Setup Menu	3-15
Figure 3-8	Conext SW Setup Menu Operational Settings	3-17
Figure 4-1	Selecting Basic Settings	4-4
Figure 4-2	Selecting Advanced Settings	4-6
Figure 4-3	Menu Map of the Conext SW Basic Settings	4-7
Figure 4-4	Inverter Settings Menu Screen	4-9
Figure 4-5	Charger Settings Menu Screen	4-13
Figure 4-6	Custom Settings Menu Screen	4-19
Figure 4-7	LithiumIon Settings Menu Screen	4-21
Figure 4-8	AC Settings Menu Screen	4-22
Figure 4-9	AC Support Menu Screen	4-23
Figure 4-10	Multi Unit Config Menu Screen	4-29
Figure 4-11	Setting a Device Number	4-32
Figure 4-12	Adv Features Menu Screen	4-33
Figure 5-1	View Device Info Log	5-4
Figure 6-1	Inverter Output Power versus Temperature Derating Graph	6-5



# Tables

Table 3-1	Front Panel LEDs	3-4
Table 3-2	Conext SW Home Screen States	3-12
Table 3-3	Meters Screen	3-14
Table 3-4	Conext SW Setup menu	3-16
Table 4-1	Setting Defaults and Ranges	4-7
Table 4-2	Basic Settings	4-7
Table 4-3	Setting Defaults and Ranges	4-9
Table 4-4	Inverter Settings Description	4-10
Table 4-5	Setting Defaults and Ranges	4-13
Table 4-6	Charger Settings Menu Description	4-14
Table 4-7	Preset Bulk Voltage Settings for Different Battery Types	4-15
Table 4-8	Preset Absorption Voltage Settings for Different Battery Types	4-16
Table 4-9	Preset Float Voltage Settings for Different Battery Types	4-17
Table 4-10	Preset Equalization Voltage Settings for Different Battery Types	4-17
Table 4-11	Setting Defaults and Ranges	4-19
Table 4-12	Custom Battery Settings Menu Description	4-20
Table 4-13	Setting Defaults and Ranges	4-21
Table 4-14	Custom Battery Settings Menu Description	4-21
Table 4-15	Setting Defaults and Ranges	4-23
Table 4-16	AC Settings menu	4-23
Table 4-17	AC Support Menu Description and Values	4-24
Table 4-18	Multi Unit Menu Description and Values	4-29
Table 4-19	Adv Features Description and Values	4-33
Table 5-1	Fault Detection Types and Behaviors	5-5
Table 5-2	Warning Types and Behavior	5-6
Table 5-3	Fault Detection Messages	5-7
Table 5-4	Warning Messages	5-11



# 1

## Introduction

The following topics will be covered in this chapter.

- Material List
- Key Features
- Basic Protection Features
- Grid-interactive and Other Features

## Materials List

Congratulations on your purchase of the Conext SW Inverter/Charger (called Conext SW). The Conext SW has been designed to give you premium true sine wave power, ease of use, and outstanding reliability for your off-grid and power backup applications.

The Conext SW ships with the following items:

- One Conext SW unit
- One set of owner's and installation guides
- One Battery Temperature Sensor (BTS)
- Two Xanbus network terminators
- Two sets of 5/16"-18 nuts and washers for the DC terminals
- Two DC terminal covers (red and black) with two sets of #6-32 screws
- One Installation bracket with one set of M6 nuts for mounting (not shown)

**NOTE:** If any of the supplied accessories are missing, contact customer service for replacement. See "Contact Information [solar.schneider-electric.com](http://solar.schneider-electric.com)" on page ii.

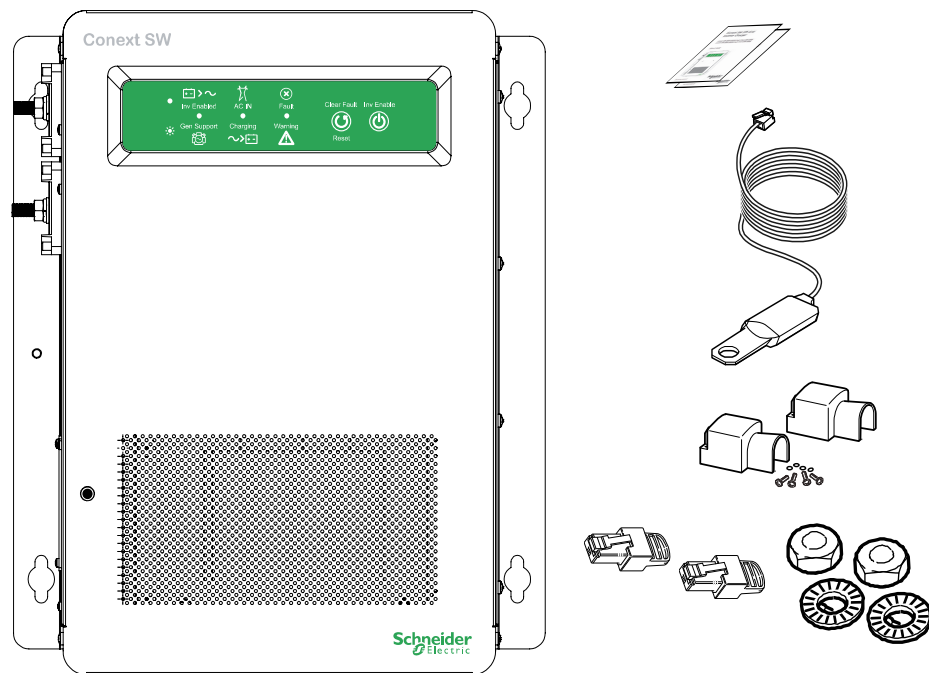

Figure 1-1 Materials List

---

## Key Features

The Conext SW Inverter/Charger is a true sine wave inverter/charger that can be used for off-grid, backup, solar, and hybrid applications. The Conext SW Inverter/Chargers are designed to operate with a wide variety of generators and are capable of operating in parallel with a generator for short durations to assist with starting large loads. The Conext SW is a convenient combination of an inverter, multi-stage battery charger, and transfer switch in one electronic device.

The Conext SW Inverter/Charger's key features are:

- **True Sine Wave output** - as an inverter, the Conext SW provides true sine wave power for your microwave, entertainment system, computer, and other loads. This power is identical to the AC source provided from the utility grid (power company).  
Some of the benefits of high efficiency true sine wave power include consistent cooking in your microwave, handling of sensitive loads such as your TV set, dimmer switches, and appliances with speed controls.
- **Multiple unit configuration** - the Conext SW Inverter/Charger has a highly versatile platform capable of parallel multiple unit configuration<sup>1</sup> to increase power levels.
- **High surge capacity** - the Conext SW Inverter/Charger has a surge rating that is twice the maximum continuous output power rating to start difficult loads like well pumps, refrigerators, or A/C compressors. See "Inverter Specifications" on page 6-2.
- **Power factor correction** - Power factor-corrected (PFC) input minimizes AC input current required for charging, increasing AC pass-through capacity.
- **Multi-stage charging** - the Conext SW Inverter/Charger has a high output, multi-stage charging capability that minimizes charging time.
- **Adjustable frequency** - the Conext SW Inverter/Charger is capable of operating from a 50Hz and 60Hz power source by extending the AC qualification frequency range. See "AC Settings" on page 4-22.
- **Temperature-controlled, variable-speed internal cooling fans** - the fans turn on when the internal temperature reaches 45 °C and reaches maximum speed at 70 °C. The fan turns off when the internal temperature falls to 40 °C.
- **Xanbus-enabled** - the Conext SW Inverter/Charger is also Xanbus-enabled which allows network compatibility and communication with other Xanbus-enabled devices. See more information under "Xanbus System" on page 2-2.

---

1. In Conext SW Inverter/Chargers, multiple unit configuration (installation) is limited to two units - one master unit and one slave unit.

## Key Features Explained

<b>Built-in Charge Formulas</b>	For the unit to perform at the highest level, the batteries must be charged correctly. The Conext SW has optimized algorithms for flooded, gel, and AGM batteries.
<b>Battery Temperature Sensor</b>	Since battery temperature is a key factor in correct charging, the charging formula must be adjusted (automatically and in real time) according to the actual battery temperature to ensure that batteries are fully charged, but not overcharged. For this reason, a battery temperature sensor (BTS) is included with the Conext SW that works with a temperature-compensated charge formula.
<b>Manual Equalization</b>	Over a period of time, the cells in a flooded battery can develop uneven chemical states. This can result in a weak (undercharged) cell which, in turn, can reduce the overall capacity of the battery. To improve the life and performance of a non-sealed, flooded battery, the Conext SW's multi-stage charging cycle includes a manual equalize mode that can be used, if recommended by the battery manufacturer.
<b>Dead Battery Charging</b>	Another feature that the Conext SW includes is dead battery charging. The Conext SW—unlike many chargers—has the ability to recharge batteries even if the battery voltage is very low, that is, as low as 12 volts.
<b>Load Management</b>	<p>The Conext SW has a built-in transfer relay that connects your inverter output or AC input from the AC generator to your loads. Because the usual AC power sources such as small generators often have limited current availability, having the capability to manage your AC loads is extremely valuable. The Conext SW provides a number of features to facilitate this.</p> <ul style="list-style-type: none"><li>• The charger is power factor corrected to use AC current as efficiently as possible. Minimizing the AC current used by the charger means more current is available for your AC loads.</li><li>• The Conext SW has a power share feature which prioritizes your AC loads by reducing the charge current depending on the load current; and programmed AC breaker setting.</li></ul> <p>Occasionally, AC input sources have low voltage. To avoid loading these weak sources any further, the charger automatically reduces its AC current draw as the AC voltage approaches the minimum acceptable level.</p>
<b>Multiple Unit Configuration</b>	<p>Conext SW Inverter/Charger supports multiple unit configuration to increase capacity. This also requires the installer to select a Master unit and a Slave unit or units.</p> <p><b>Multiple Unit Inverting</b></p> <p>Multiple unit configuration allows two inverter/chargers to operate in parallel thereby doubling the capacity in inverter mode. The multiple inverters communicate over the Xanbus network and intelligently manage the load balance between the units.</p>



### Multiple Unit Charging

Multiple Conext SW Inverter/Chargers synchronize charging stages to ensure efficient charging of the battery bank. When a single unit transitions from bulk to absorption so do all other units. In absorption, all units must complete the absorption stage before transitioning to the next stage. Note that units do not load share when charging except during the bulk stage. The Conext SWs stop sharing charge current just before completing the bulk stage. The units do not share charge current during the absorption and float stages.

Each unit charges batteries based on the Max Charge Rate setting and active internal (temperature-based) deratings.

If equalization is enabled on one or more devices capable of equalization charging, only those devices perform an equalize cycle after absorption. Other devices transition to float (if three-stage charging is selected) or transition to AC pass-through (if two-stage charging is selected).

## Basic Protection Features

The Conext SW has the following protection features:

- Over temperature shutdown for critical components such as the transformer and the power board
- Battery temperature sensor (BTS) failure/battery temperature out-of-range fault protection
- DC output over voltage protection during charge mode
- AC output overload and short circuit protection during invert mode
- AC backfeed<sup>1</sup> protection

The Battery Temperature Sensor (BTS) provides these protection features:

- Battery over temperature charging protection preventing battery charging at 60 °C or higher
- Charging voltage compensation based on the temperature of the battery the BTS is connected to

---

1. An AC backfeed error occurs when the AC output of the inverter/charger is connected or routed back to the inverter/charger's AC input terminal or if the an AC internal transfer relay error is detected.

## Grid-interactive and Other Features

### Load Shaving

Load shaving (**Load Shave**) allows the Conext SW to support (or assist) the AC source in powering local loads during a defined window of time (**LoadShaveStart** and **LoadShaveStop**). See “Time-of-Use Metering” on page 1–7. It allows the inverter to control how much current can be drawn from the AC source. When the Conext SW inverter detects that the AC input current is over a set limit called **Load Shave Amps**, it uses battery power to limit the peak load on the AC Input by providing the difference in amps between the actual load current and the current limit set in **Load Shave Amps**.

When **Load Shave** is enabled and within **LoadShaveStart** and **LoadShaveStop** times, it will automatically transition into and out of load shaving operation.

- To transition into the load shaving state, the inverter must first detect that the AC Input current exceeds the **Load Shave Amps**. It will then turn on the inverter and source current so that the AC Input current matches exactly the current in **Load Shave Amps**.
- To transition out of the load shaving state, the inverter detects that the input current is below the **Load Shave Amps** and it no longer needs to support the loads with power from the battery.

**In a grid-interactive backup system** Load shaving combined with time-of-use metering helps reduce utility peak demand surcharges.

**In an off-grid system with generator** Load shaving can be used to support the generator. If the generator is unable to provide enough current to run loads in the system, load shaving ensures that the system does not exceed the generator's current rating. This is done by matching the generator's manufacturer recommended current rating with the **Load Shave Amps** setting.

See “Load Shaving Setting” on page 4–26 for a sample scenario.

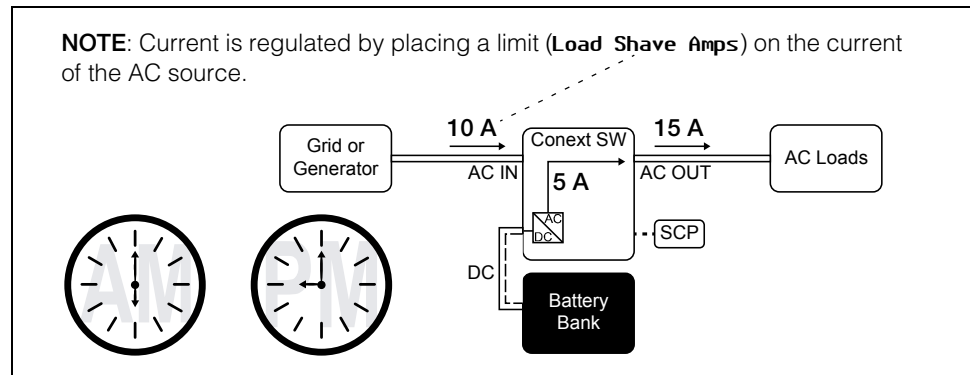

**Figure 1-2** Load Shaving in Action

**Time-of-Use Metering** Utilities use time-of-use metering to set utility charges during peak usage hours and to impose a surcharge. The Conext SW can be configured (using the **LoadShaveStart**, **LoadShaveStop** and charger block [see the Conext SW Owner's Guide] settings) to overcome these peak charges by using utility power to charge the battery bank during the inexpensive energy hours and consuming the battery energy during expensive energy hours.

For example, if charger block is set between 9:00 AM and 10:00 PM and load shaving is set between **LoadShaveStart**=6:00 PM and **LoadShaveStop**=9:00 PM, charging on AC Input stops at 9:00 AM and the inverter continues to pass utility AC through to the loads. If charging is required during the charger block period then Conext SW can use an alternative external renewable energy source such as an MPPT solar charge controller to charge the battery bank. The inverter connects to the utility grid at 6:00 PM and supports running the loads using the batteries. The inverter continues to run the loads until 9:00 PM.

The Conext SW then stops supporting the utility grid and passes utility AC through to the loads at 9:01 PM. At the end of charger block at 10:00 PM utility AC begins maintaining the batteries based on charger settings.

The above example allows an external renewable energy source to be utilized as a primary charging source during a desired time window. The charger (using utility power connected to AC Input) can then be used to supplement battery charging when the utility rates are low.

When using the system for time-of-use metering, the system should be designed with a battery capacity large enough to support loads during the entire peak rate period without reaching the low battery cut out (**Low Batt Cut Out**) setting.

Load shaving can also be used with time-of-use metering and enhanced AC support feature (see "Enhanced AC Support" on page 1–8 and "Enhanced AC Support Setting" on page 4–28) to support self-consumption.

## AC Support

AC Support is similar to load shaving because in both cases the Conext SW inverter supplements AC current. However, unlike load shaving, AC Support ensures that no current comes from the AC Input connection of the Conext SW as long as the battery's state-of-charge (SOC) or battery voltage conditions allow it. AC Support allows the Conext SW to support local loads by converting excess power from external DC sources connected to its battery bank. Examples of external DC sources are MPPT solar charge controllers. When local loads demand more energy from the external DC sources then extra current can be pulled in from the AC source as a last resort. When operating without a solar charge controller in the system, set the battery charge cycle to **2StgNoFloat** to allow AC Support to function immediately after the absorption charge stage.

AC Support behaves three different ways depending on the type of equipment that is installed in the Xanbus network with the Conext SW.

- SOC - Xanbus-enabled battery monitor is installed
- Enhanced - Xanbus-enabled MPPT solar charge controller is installed
- Regular - neither Xanbus-enabled battery monitor nor MPPT solar charge controller is installed

## AC Support Mode using SOC

With AC support on SOC (**AC Supp on SOC**) enabled, Conext SW maximizes power utilization using stored energy in a battery bank within a grid-interactive backup power system. AC support mode allows the Conext SW to accurately determine when grid power can be used to supply energy to the loads by knowing the state-of-charge (SOC) of the battery bank.

The SOC of a battery bank is monitored by using a Xanbus-enabled battery monitor. SOC entry and exit points are determined by the user. The SOC entry point (**AC Supp Start Soc**) which is a high percentage value determines when AC support mode is engaged and the SOC exit point (**AC Supp Stop Soc**) which is a low percentage value determines when AC support mode is disengaged. See “AC Support Settings” on page 4–23.

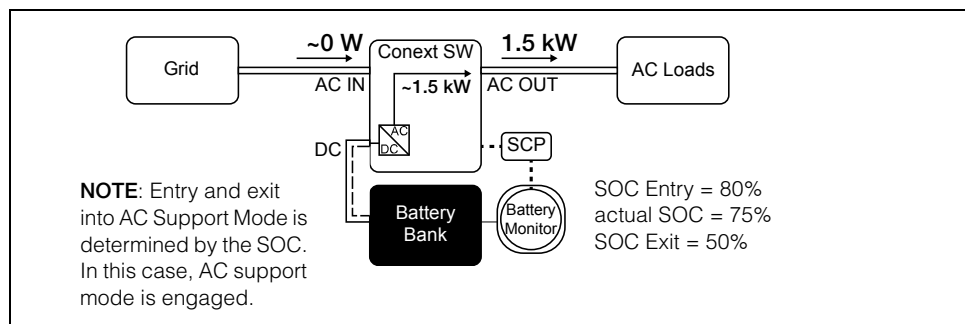

Figure 1-3 AC Support Mode using SOC

## Enhanced AC Support

Enhanced AC Support (**EnhancedACSup**) works when power systems are DC coupled with a Xanbus-enabled MPPT Solar Charge Controller. This means that DC power from a renewable source such as an MPPT Solar Charge Controller is used to charge the battery bank while simultaneously utilizing its power (by way of inverting) to power loads. Entry and exit to enhanced AC support are controlled by the MPPT charger so that they can control the state-of-charge of the batteries. AC power from the grid is utilized only when load demand exceeds power available from the MPPT charger for charging and supplying the loads.

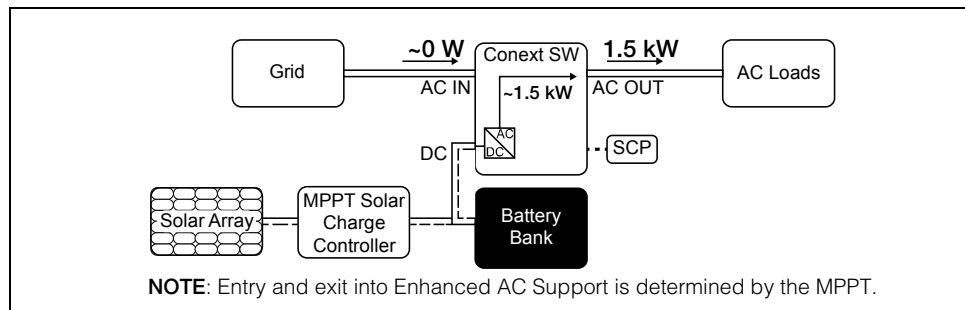

Figure 1-4 Enhanced AC Support

When enhanced AC support mode is enabled, the Conext SW automatically tracks the MPPT solar charge controller's charging voltage as it transitions from bulk to absorption to float. By tracking the voltage, the Conext SW is then able to execute and finish the charging cycle using DC power from the solar charge controller while converting its excess DC power to AC power to support the grid by supplying more current. Conext SW only uses excess DC power not required by the battery to support the grid thus, it prioritizes charging the battery before supporting the loads. Battery health is improved because the system always executes a three stage charging of the battery that ensures battery SOC is as close as possible to 100% at all times. Systems that use a fixed voltage for AC support (or similar) start to support loads sooner and may not fully charge the battery bank, leaving the battery in a partial SOC. Prolonged periods of partial SOC can degrade battery performance. Enhanced AC support limits this degrading effect.

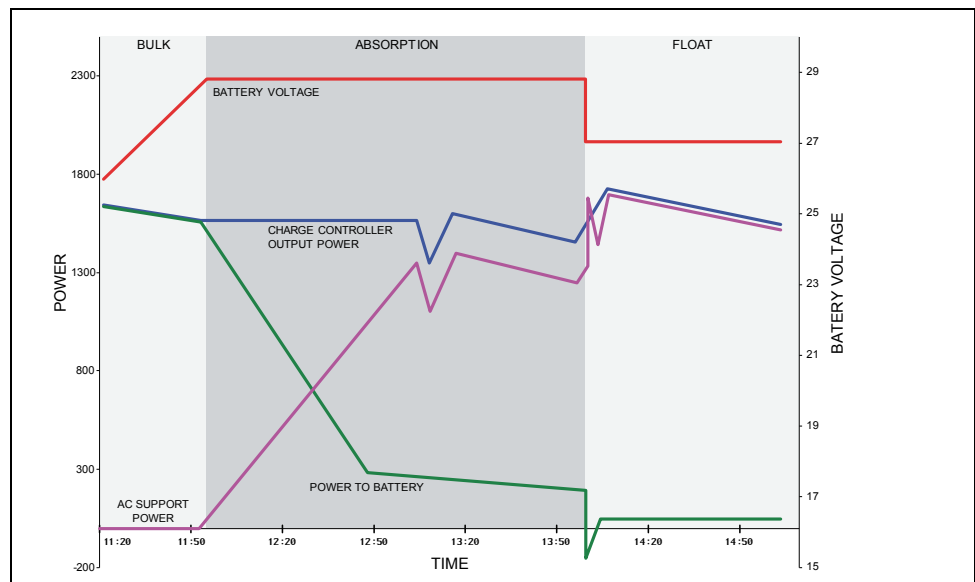

Figure 1-5 Enhanced AC Support Charge Cycle

### Enhanced AC Support Charging Stages

- **BULK Phase** - During this phase, all PV energy from the charge controller is diverted to the battery for maximum charging. During this phase, the Conext SW does not engage AC support.
- **ABSORPTION Phase** - Once the charge controller is in absorption phase, the charge controller output is split between the battery and Conext SW for supporting AC loads. As the battery approaches full charge, more power from the charge controller is diverted to Conext SW for AC support.
- **FLOAT Phase** - Once the battery is full and the charge controller transitions to float phase, almost all the charge controller output is used by Conext SW to support AC loads. The battery only receives a trickle charge to maintain a healthy state of charge.

See “Enhanced AC Support Setting” on page 4–28.

## Regular AC Support without Xanbus devices

If no Xanbus-enabled devices, such as an MPPT charge controller, are connected to the power system, then entry and exit into AC support mode is based solely on battery voltage monitored by Conext SW. If the battery voltage is above a set limit (**AC Supp Volts**), then AC support mode is engaged.

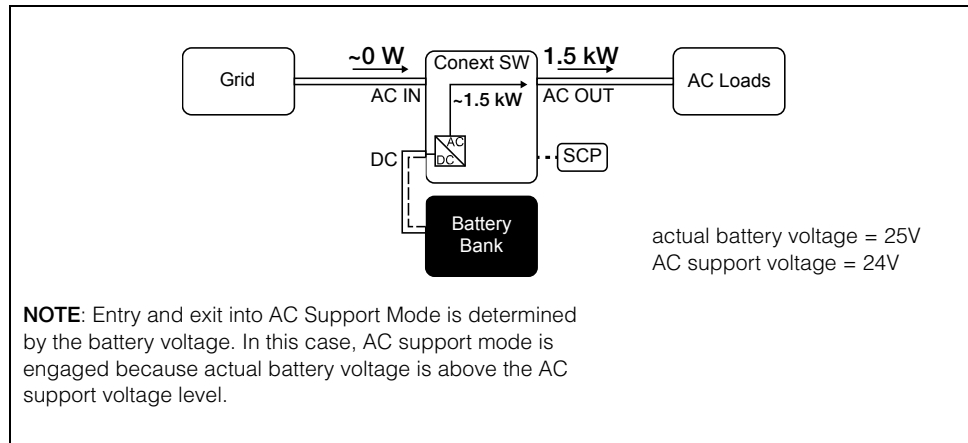

**Figure 1-6** Regular AC Support without Xanbus Devices

With its charger enabled, the Conext SW enters AC support mode only after completing a charge cycle when it is first powered up or reconnected to the grid.

For regular AC support mode set the Conext SW's battery charge cycle to **2StgNoFloat** to allow AC Support feature to function immediately after the absorption charge stage.

## Grid-Interactive Delay Feature

Conext SW has a delay feature that postpones the engagement of two grid-interactive features, namely load shaving and AC support, until a connected MPPT solar charge controller has had a chance to charge the battery for two hours in Float mode. The delay feature is called **PLSDelay** in SCP. The delay feature prioritizes the MPPT solar charge controller's ability to sufficiently charge the battery bank. The feature works by inhibiting grid-interactive operation for two hours from the time the charge controller transitions from Absorption to Float charging. This allows the battery to be fully charged before either load shaving or AC support mode is engaged. This feature is useful in applications where battery micro-cycling is to be minimized in order to maximize battery life. See below.

**Example:** **Load Shave = Enabled**  
**LoadShaveStart = 10:00AM**  
**PLSDelay = Enabled**

Absorption to float charging starts at 7:00 AM and load shaving is set to start at 10:00 AM. Absorption transitions to float at 9:00 AM but because **PLSDelay** is enabled, the 2-hour delay inhibits load shaving to actually start at 10:00 AM. Because of the 2-hour delay, load shaving does not start until 11:00 AM. See "Load Shaving 2-Hour Delay Example" on page 1-11.

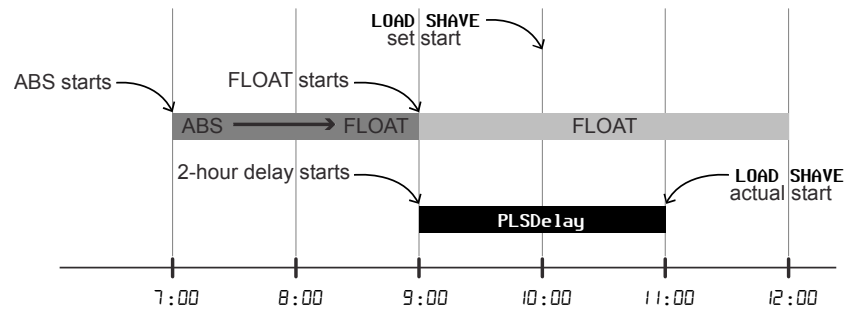

**Figure 1-7** Load Shaving 2-Hour Delay Example

The feature also ensures that self-consumption of harvested solar energy is optimized. The 2-hour delay works only under the following conditions:

- Conext SW's battery charge cycle must be set to **2StgNoFloat**
- **PLSDelay** must be set to **Enabled**
- an MPPT solar charge controller must be connected and detected in the Xanbus network
- the feature must not have been activated within that day

This configuration can be enabled or disabled in “Advanced Features Menu” on page 4–33. The default setting for **PLSDelay** is **Disabled**.

## AC Coupling

Off-grid AC Coupled system architecture is often used to create a stand-alone grid. Commonly this means that PV inverters are connected to the output of a battery-based inverter/charger putting both on the same AC bus along with the AC loads. In this scenario, the battery powered inverter charger provides the necessary frequency and voltage to enable the PV inverter to produce power. This type of system must be able to maintain power generation in balance with power consumption at all times. If there is more power being generated than can be consumed by the loads, power will flow to the inverter/charger and be converted to DC power which flows into the battery. Once the battery reaches capacity, power generation by the PV inverter must be curtailed to maintain the balance between generation and consumption. As the battery bank reaches capacity, Conext SW curtails PV inverter generation by raising the AC line frequency causing compatible PV inverters to reduce their power output in an orderly manner. This is called Active Frequency Shift Power Curtailment.

During a grid outage even a home with a grid-tie PV inverter system will be without power because PV inverters cannot produce power without the presence of a reference voltage and frequency. To enable the PV inverter to provide power during a grid outage the Conext SW is retrofitted in front of the PV inverter. The PV inverter is rewired from the grid connection to a critical load (sub) panel and the AC Couple is on the Conext SW AC Output port.

Consult the manufacturer's specifications to determine if your PV inverter is compatible with Active Frequency Shift Power Curtailment. Conext SW's AC coupling function is enabled by default (see "Advanced Features Menu" on page 4-33).

### **NOTICE**

#### **AC COUPLED PV INVERTER COMPATIBILITY**

AC power generated by AC coupling PV inverters with Conext SW must be consumed by AC loads or used to charge batteries. As an alternative, the excess power produced from a PV inverter can be routed to dump loads. Do not AC couple PV inverters with the Conext SW that are unable to reduce, derate or cease the excess PV inverter power in response to the changes in AC line frequency controlled by the Conext SW. Consult the manufacturer's specifications of your PV inverter and confirm compatibility.

**Failure to follow these instructions can result in equipment damage.**

The AC coupling advanced setting should remain enabled except in cases when the DC voltage level is allowed to have large variations and the line frequency needs to remain constant.

Further details about AC Coupling can be found in the document "AC Coupling Solutions Guide (Document Number: 976-0240-01-01)" available at [solar.schneider-electric.com](http://solar.schneider-electric.com).

## **Storing the State of the Inverter Mode**

You can enable or disable a feature called **StoreInvState** which, when enabled remembers the state of the inverter mode prior to a power down (that is, when AC and DC power sources are disconnected). When the Conext SW is powered up again, the inverter mode reverts back to its prior state.

See "Advanced Features Menu" on page 4-33.

## **NoLoadVD**

The No Load Voltage Derating (**NoLoadVD**) feature further reduces tare loss by adjusting output voltage by +4%/-5% of nominal, over the full load range. That means at 50% load, the output voltage is at nominal but 5% below nominal at No Load. The feature results in slight increase on overall operating efficiency but may result in visible flicker of incandescent or similar lights during large sudden load changes.

See "Advanced Features Menu" on page 4-33.



---

## Low Battery Cut Out Hysteresis

Low battery cut out (**Low Batt Cut Out**) (LBCO) preserves battery life by stopping the inverter when battery voltage drops down to the LBCO value for a few seconds (see **LBCO Delay** below), then battery charging commences. When charging starts, the voltage level jumps a little but enough that inverting might resume abruptly. Then, battery voltage goes down again and charging starts abruptly. To prevent the inverter from switching abruptly between inverting and charging, the **LBCO Hysteresis** value is added to the LBCO value to allow the battery voltage to reach a sufficient energy capacity level before inverting resumes. This feature contributes to battery health.

See “Advanced Features Menu” on page 4–33.

## LBCO Delay

LBCO Delay (**LBCO Delay**) is the amount of time in seconds before inverting is interrupted due to low battery voltage.

See “Advanced Features Menu” on page 4–33.

## Lithium Ion Battery Type

See “Lithium Ion Battery Settings Menu” on page 4–20.

Further details about Lithium Ion support can be found in the document “*Lithium Ion Application Note (Document Number: 976-0319-01-01)*” available at [solar.schneider-electric.com](http://solar.schneider-electric.com).

<b>⚠ WARNING</b>
<b>BATTERY TYPE HAZARD</b> When using Lithium Ion batteries, ensure that the battery pack being used includes a Battery Management System (BMS) with safety protocols. <b>Failure to follow these instructions can result in property damage, death or serious injury.</b>



# 2

## Components and Mechanical Features

The following topics will be covered in this chapter.

- System Components
- Mechanical Features

## System Components

The Conext SW uses Xanbus, a network communications protocol developed to send Conext SW's operational settings and status to other Xanbus-enabled devices. You can configure and monitor the Conext SW and every Xanbus-enabled device in the system using an optional System Control Panel (SCP).

Another component is the optional Automatic Generator Start (AGS) which allows operation with a wide range of generators, supported through a dedicated generator input. Simply, the AGS automatically starts and stops your generator.

Solar charge controllers allow renewable energy collected from the sun to charge batteries as might be the case in an off-grid application of Conext SW. The charge controllers form part of the Xanbus network.

See "Xanbus-enabled Products and Other Accessories" on page 2-3 for part numbers.

## Xanbus System

The Xanbus system includes the Conext SW and other Xanbus-enabled devices. The Conext SW is the device in a Xanbus system that typically provides network power—500 mA at 12 VDC. All of the Xanbus-enabled devices, such as the Conext SW, the SCP, and the AGS are able to communicate their settings and activity to each other.

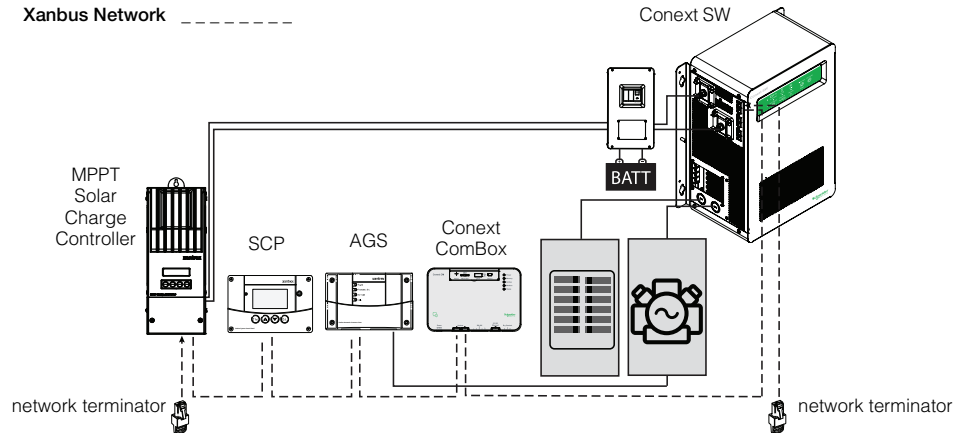

**Figure 2-1** Xanbus System Components

The Xanbus-enabled designation (see left) means that this product works on a Xanbus network. Xanbus-enabled products are:

- Simple to operate and routine tasks are automated.
- Controlled by software that eliminates analog signalling errors.
- Less susceptible to interference and line loss.
- Upgradable through new software releases.

**xanbus**<sup>™</sup>  
E N A B L E D

For detailed instructions and a complete list of Xanbus-enabled devices, visit [solar.schneider-electric.com](http://solar.schneider-electric.com).

## Xanbus-enabled Products and Other Accessories

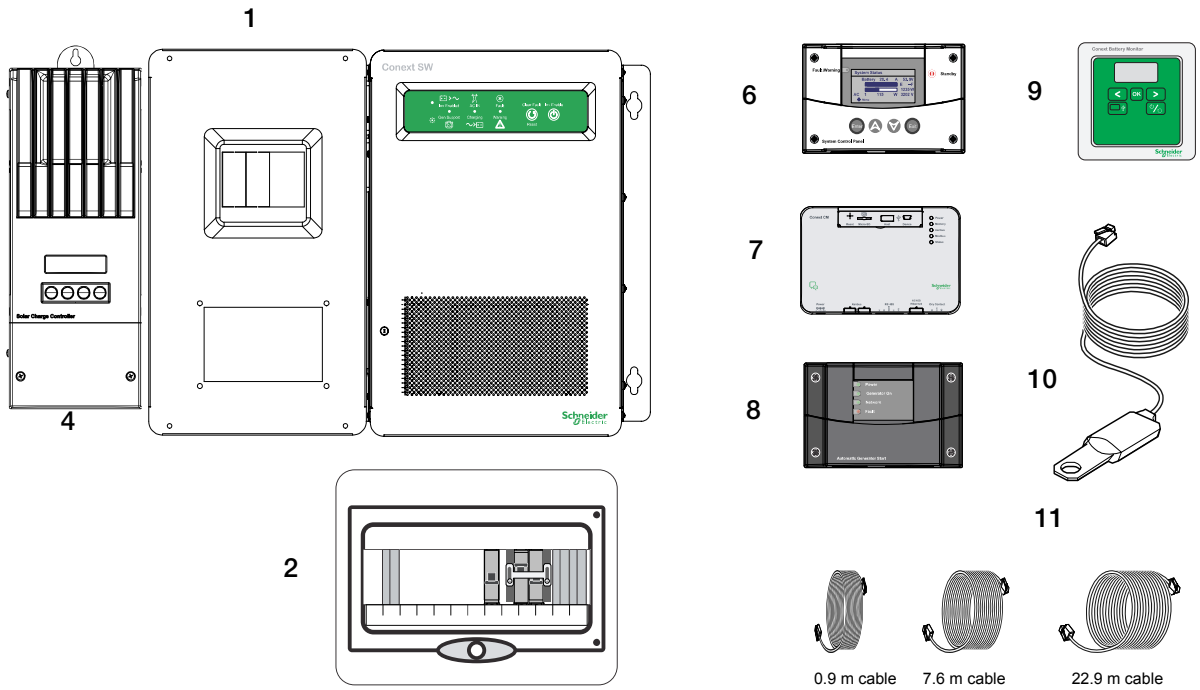

	Product/Accessory (Shown above)	Product Number/s
1	Conext SW DC Switchgear	865-1016
2	Conext SW AC Switchgear	865-1017-61
3	Stacking Kit (not shown)	865-1019-61
4	MPPT 60 150 Solar Charge Controller	865-1030-1
	MPPT 80 600 Solar Charge Controller (not shown)	865-1032
5	Conext SW On/Off Remote Switch (not shown)	865-1052
6	System Control Panel (SCP)	865-1050
7	Conext ComBox	865-1058
8	Automatic Generator Start (AGS)	865-1060
9	Conext Battery Monitor	865-1080-01
10	Battery Temperature Sensor (BTS)	808-0232-02
11	3-ft network cable (0.9 m)	809-0935
	25-ft network cable (7.6 m)	809-0940
	75-ft network cable (22.9 m)	809-0942

## Conext SW Inverter/Charger Mechanical Features

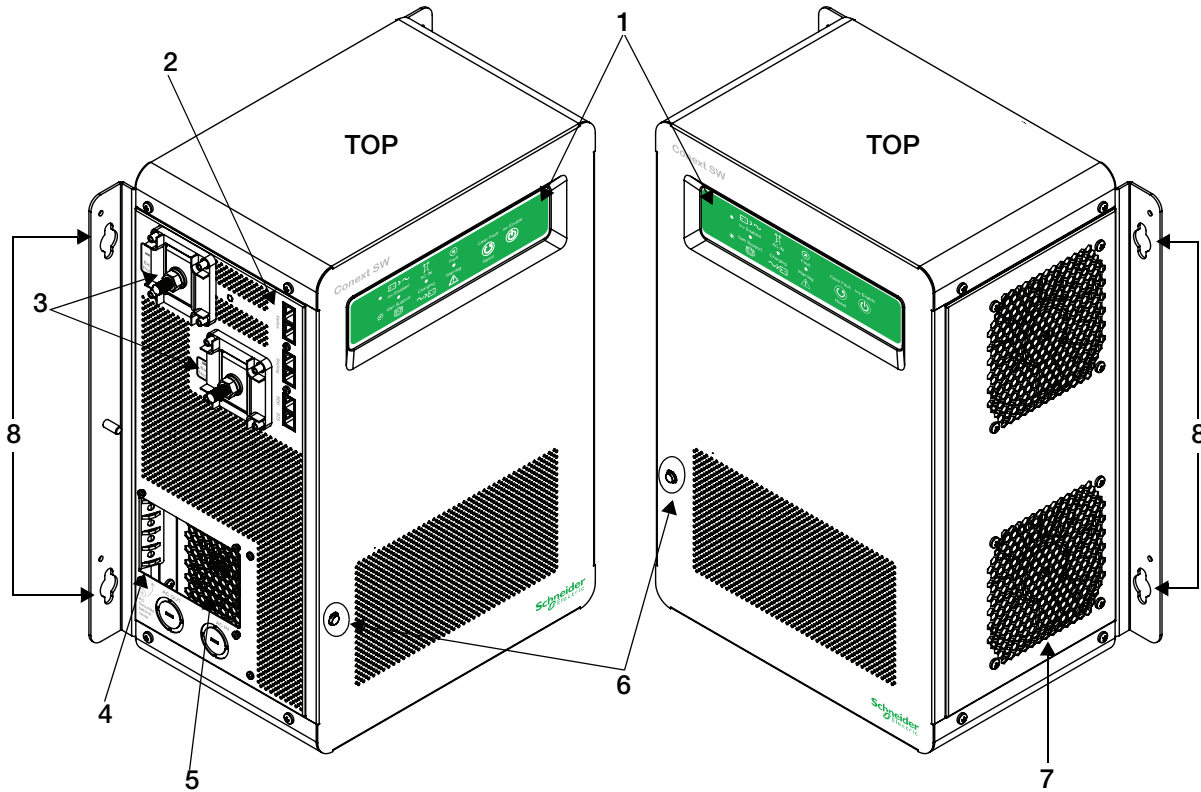

Figure 2-2 Conext SW Front and Side Panels

### Conext SW Front and Side Panels

Before you begin to operate the Conext SW, review the front panel features shown in Figure 2-3 and described in the next table. A detailed view of the lights and buttons on the front panel is also shown.

Item	Description
1	Front Panel contains the Inv Enable and Clear Fault   Reset buttons, as well as various LEDs (status indicator lights). See “Front Panel Buttons and Status LEDs” on page 2–5.
2	Network and communications ports. See “AC and DC Terminals, Network and Communication Ports Panel” on page 2–6.
3	DC battery terminals. See “AC and DC Terminals, Network and Communication Ports Panel” on page 2–6.
4	AC Ground terminals. See “AC and DC Terminals, Network and Communication Ports Panel” on page 2–6.

Item	Description
5	AC line terminals. See “AC and DC Terminals, Network and Communication Ports Panel” on page 2–6.
6	Manual reset button for the built-in 30-amp AC input circuit breaker.
7	Two variable-speed cooling fans maintain a cool internal temperature of critical components. The two fans control airflow through the transformer and power compartments of the unit. Ensure at least 250 mm of clearance for proper ventilation.
8	Mounting holes for permanent installation.

### Front Panel Buttons and Status LEDs

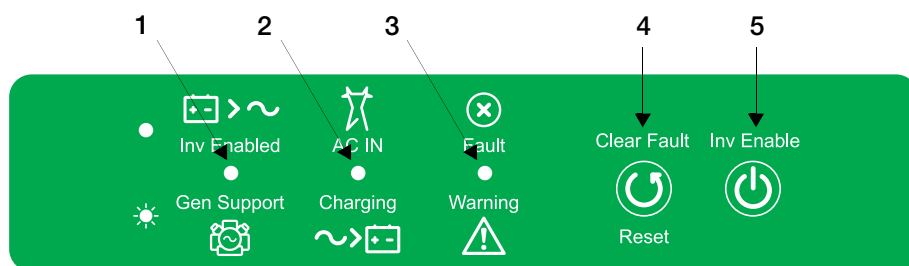

Figure 2-3 Front Panel Buttons and Status LEDs

Item	Description
1	<p>The <b>Inv Enabled</b> LED illuminates steadily when invert mode is enabled. If AC is present and invert mode is enabled, this LED remains illuminated even though AC power is being passed through.</p> <p><b>Gen Support</b> LED flashes intermittently when the inverter is in AC support and load shaving mode.</p>
2	<p>When AC is present and qualified, the <b>AC IN</b> LED will illuminate steadily indicating also that AC is passing through.</p> <p><b>Charging</b> LED flashes intermittently when the Conext SW is in charge mode and is producing DC output to charge your batteries.</p>
3	<p><b>Fault   Warning</b> LED illuminates steadily if a fault is detected (a fault detection condition) and flashes intermittently when a warning condition is active.</p>
4	<p><b>Clear Fault   Reset</b> button is used to clear any fault detections if pressed momentarily. If held down for more than three seconds, the unit will reset (reboot) itself.</p>
5	<p><b>Inv Enable</b> button is used to enable and disable inverter mode. “Enabled” is different from the inverter being “on”. When enabled, the inverter can be on or off. When disabled, the inverter is always off.</p>

### Conext SW AC/DC/Ports Side Panel

**⚠ DANGER**

**ELECTRICAL SHOCK AND FIRE HAZARD**

Installation must be done by qualified personnel to ensure compliance with all applicable installation and electrical codes and regulations. Instructions for installing the Conext SW are provided in a separate installation guide for use by qualified installers only.

**Failure to follow these instructions will result in death or serious injury.**

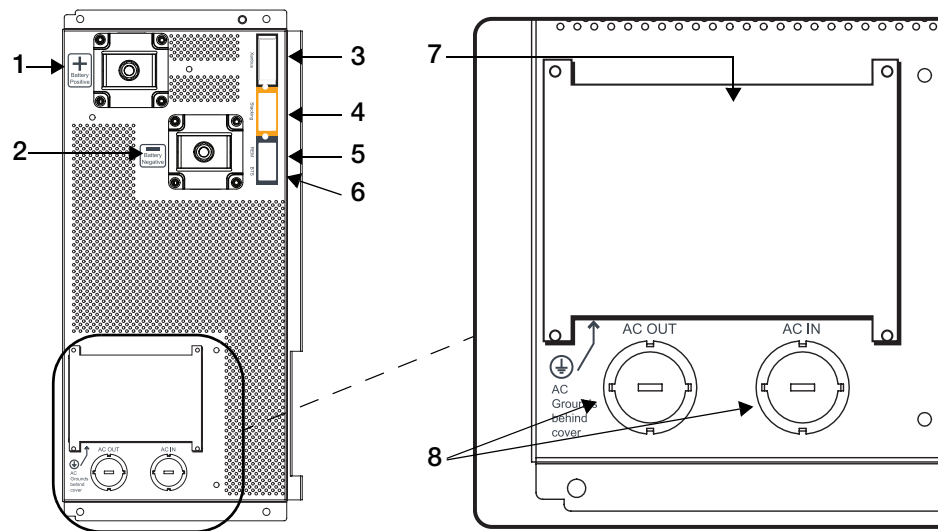

**Figure 2-4** AC and DC Terminals, Network and Communication Ports Panel

Item	Description
1	<b>Battery Positive (+)</b> DC terminal connects to the positive battery cable (red).
2	<b>Battery Negative (-)</b> DC terminal connects to the negative battery cable (black).
3	<b>XANBUS</b> interface ports are used to connect Xanbus-enabled devices including the optional SCP and AGS.
4	<b>STACKING</b> port. Feature not available in these models.
5	Remote ( <b>REM</b> ) port provides connection for the on/off remote switch.
6	Battery temperature sensor ( <b>BTS</b> ) port provides connection for the battery temperature sensor (supplied).
7	AC input/output wiring compartment access panel with the compartment cover
8	AC knockouts



# 3

## Operation

The following topics will be covered in this chapter.

- Start Up Behavior
- Conext SW Front Panel
- Conext SW with the SCP – System Control Panel
- Battery Charging Reference

## Start Up Behavior

When the Conext SW is powered up (energized) or has been reset (using the Reset button on the front panel), all of the front panel LEDs illuminate and remain on for a minimum of five seconds. During this interval, the fans also turn on as the unit executes internal diagnostics.

The Conext SW inverter function is initially disabled (meaning the unit will not invert even if there is sufficient battery voltage) every time the Conext SW is energized for the first time. After being energized, the **Inv Enable** button on the front panel can be used to enable or disable the inverter. A separate control device called a System Control Panel (or SCP) may also be used to enable or disable the inverter. However, the unit will remember its inverter function setting in succeeding operations. This means that if the inverter function is left enabled before a reset or power down-power up cycle, the inverter function will remain enabled.

When a function is enabled, it generally means that it is “standing by” and other conditions may have to be met before the function is utilized. For example, the charger function on the Conext SW may be enabled, but it will not charge unless qualified AC power is present. Similarly, even if the inverter function is enabled, inverting may not occur if the batteries cannot supply the energy required for the loads.

---

**IMPORTANT:** Review the “Important Safety Instructions” on page v before operating the inverter/charger.

---

## Inverter Operation Using the Front Panel

**IMPORTANT:** Review the “Important Safety Instructions” on page v before operating the inverter/charger.

Once the inverter/charger is installed, you can operate it in invert mode. The steps below will test the unit for normal operation using the front panel.

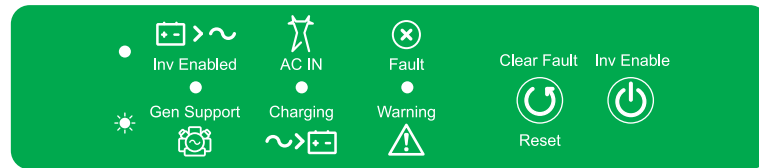













### To test the inverter using the front panel:

1. Press the **Inv Enable** button on the Conext SW on the front panel. The **Inv Enabled** ● LED illuminates.
2. Turn on the main AC breaker or AC disconnect to supply AC input power to the inverter.

**NOTE:** The **Inv Enabled** ● LED will remain lit. However, AC will continue to be passed through (also called AC bypass) to the loads until conditions exist that cause AC to be disqualified, in which case the unit will start inverting. The **AC IN** ● LED should also illuminate. The **Charging** ⚡ LED will start flashing to indicate that the unit is charging the battery. The charger automatically starts when qualified AC power is connected and when the battery is not fully charged.

3. Turn off the main AC breaker or AC disconnect to stop AC input power from going into the inverter.
4. Place a load on the inverter. This also usually means turning on the inverter's AC distribution sub-panel's breaker switch.
5. Connect a load such as a lamp into an outlet connected to the sub-panel circuit and turn it on. The lamp lights up.
6. Repeat step #2. The lamp will remain lit up.
7. Repeat step #3. The inverter/charger should invert immediately. The transfer relay will make a clicking sound and the **Inv Enabled** ● LED will illuminate. The lamp should remain lit up. If any part of this test does not happen correctly, determine the cause before continuing to use the unit.
8. Monitor the Conext SW front panel.  
The indicator LEDs on the front panel show you the operating status of the Conext SW. A description of the LEDs is provided in Table 3-1.  
If none of the front panel LEDs are on, see “General Troubleshooting Guidelines” on page 5-2.

**Table 3-1** Front Panel LEDs

Icon	LED	Status	Action (or Status Item)
 Inv Enabled	Steady Green 	If generator or grid AC is unavailable and operating conditions are met, the Conext SW will produce AC voltage to power loads.	You can run your appliances from the inverter.
 Gen Support	Flashing Green 	The inverter is in AC support or load shaving mode.	You can run your appliances from the inverter.
 AC IN	Steady Green 	When the Conext SW is connected to a generator or grid and is producing qualified AC, the AC IN light illuminates.	You can run your appliances using passed-through AC.
 Charging	Flashing Green 	Conext SW is connected to a qualified AC source, is charging and passing-through power to AC loads.	Your battery bank is being replenished and AC loads are receiving power from a qualified AC source.
 Fault	Steady Red 	A fault has been detected on the network.	Investigate and clear the fault detection condition.
 Warning	Flashing Red 	A warning is detected.	Investigate by examining warning logs on SCP.

**Fault Detections and Warnings** A fault detection condition affects the operation of the unit. A fault detection sometimes requires user intervention by clearing the condition using the **Clear Fault** button on the inverter/charger’s front panel. Press the button once to clear the condition. See “Troubleshooting” on page 5–1 for information on clearing fault detections from the SCP.

A warning alerts you to a condition that could possibly affect operation of the unit. A warning usually precedes a fault detection condition.

**IMPORTANT:** If you are having problems with any of your loads, refer to “Inverter Applications” on page 5–3.

## Operating Limits for Inverter Operation

**Temperature** The Conext SW series of inverter/chargers will operate at rated power continuously at 25 °C with some models capable of continuous operation at much higher ambient temperature. However, the continuous power rating at elevated ambient temperature may differ between models. See “Environmental Specifications” on page 6-5 for full details. In higher ambient temperatures, if the loads draw full power for an extended period of time, the unit may shut down to protect itself against overheating.

**Surge Power** The Conext SW series of inverter chargers feature a surge rating of 200% of rated power for five seconds at 25 °C. See “Inverter Specifications” on page 6-2 for full details. Operating the inverter/charger in conditions outside of normal rated power and temperature limits, however, will result in thermal shutdown and/or significantly decreased performance. See “Inverter Specifications” on page 6-2 for information on continuous operation at higher than rated power.

**Difficulty on starting loads** The inverter/charger should be able to operate all AC loads rated at or below its power rating. Some high horsepower induction motors used in pumps and other motor-operated equipment require very high surge currents to start, and the inverter/charger may have difficulty starting these loads.

If you have problems starting certain loads, ensure that:

- The battery connections are tight and clean.
- The DC cabling is no longer than the recommended length. Refer to the *Conext SW Inverter/Charger Installation Guide* for this information.
- The AC wiring is of recommended size. Refer to the *Conext SW Inverter/Charger Installation Guide* for this information.
- The battery is of sufficient capacity and is fully charged.

**Battery power during AC bypass** When sufficient AC is detected by the inverter/charger and the battery is sufficiently charged, the AC is automatically passed through to the loads. However, if the battery is less than 12 V (for 24-volt models), 24 V (for 48-volt model), or had been disconnected, the inverter/charger will not pass grid AC through to the loads.

### **NOTICE**

#### **EQUIPMENT DAMAGE**

Do not energize and operate the inverter/charger with an AC source before connecting a battery. Do not rely solely on AC bypass power to provide energy to connected loads. Always operate with a battery connected to the inverter/charger.

**Failure to follow these instructions can damage the inverter/charger.**

## Operating Limits for Charger Operation

By default, the maximum charger output current is the rated charger output current for the particular model. Using the SCP, you can reduce the total output if you change the maximum charge rate (**Max Chg Rate**) on the Conext SW Basic Settings menu or Inverter Settings menu under Advanced Settings.

The charger can charge batteries when the AC input voltage is within the minimum and maximum range of 170 to 270 VAC. They are the default minimum and maximum settings. The minimum range setting can be adjusted from 170 to 220 VAC and the maximum range setting from 240 to 270 VAC. The charger can also be configured to accept and operate from a wide AC source frequency of between 40 to 70 Hz. The default range setting is between 45 to 55 Hz. This wide range allows the Conext SW to charge your batteries even when incoming AC voltage becomes less than the typical 50 Hz.

**Power Share** The Conext SW charger uses AC INPUT L to charge the batteries. The AC loads have priority, which means that the charger will reduce its output with large AC loads and increase the output again when the AC load decreases. The regulatory maximum for continuous AC loads is 80% of the breaker rating that the loads are connected to.

The Conext SW senses pass-through current going to the AC load. The difference between the pass-through (load) and 80% of the Power Share setting is the current that is available for charging the batteries.

For example, if the AC input of the Conext SW is from an AC panel with a 30-amp breaker, the Power Share setting on the SCP should be selected as 30-amp. Based on this, the charger will control the charge current so that the total current draw is equal to or less than 24 amps in this case. Should the load current be more than about 24 amps, the charger output will reduce to zero (0) amp, but the Conext SW will continue to supply power to the loads. The Conext SW will continue to pass-through power to the loads, even if the load current exceeds the Power Share setting. In this case, it will be up to the user to remove/disconnect loads if tripping the AC input breaker supplying the Conext SW is to be avoided.

## Inverter/Charger Operation using the System Control Panel (SCP)

This section contains detailed information and procedures for using your Conext SW in conjunction with the SCP.

If you're using the SCP to operate or monitor the status of the unit, you may also refer to the *System Control Panel Owner's Guide*.

The SCP provides operating, configuring, and monitoring capability for your Xanbus system.

The System Control Panel:

- Monitors activity throughout your power system.
- Displays the latest information about your inverter/charger, battery voltage level, battery charge output, and generator start and stop activity.
- Displays the settings for each Xanbus-enabled device in the system.
- Enables you to adjust the settings for each Xanbus-enabled device in the system.
- Preserves all of its settings if system power is interrupted. After power is restored, you don't have to reconfigure the SCP or any of the Xanbus-enabled devices connected to it.

The SCP provides remote configuration and monitoring capabilities for the Conext SW and other Xanbus-enabled devices in the power system. Please refer to the *System Control Panel Owner's Guide* for complete information on using the System Control Panel.

You can monitor Conext SW operation on the SCP using the:

- System Status screen (see page 3–10)
- Conext SW Home screen (see page 3–11)
- Conext SW Meters Menu (see page 3–14)

## SCP Features

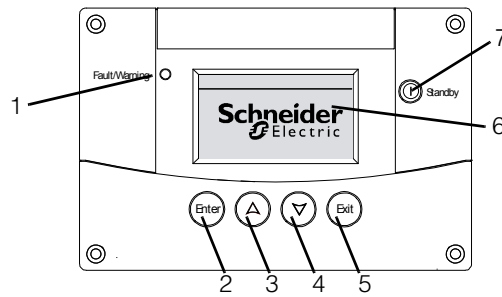

Feature	Description
1	Fault/Warning light indicates a device has a fault detection or warning condition and requires attention. The light flashes when a warning occurs and turns on steadily when a fault detection occurs.
2	Enter button confirms selection of a menu item or displays the next screen.
3	Up arrow button scrolls upward through screen text or increases a selected value.
4	Down arrow button scrolls downward through screen text or decreases a selected value.
5	Exit button cancels selection of a menu item or displays the previous screen.
6	Screen shows menus, settings, and system information.
7	Standby button disables inverting and charging on all Conext SW units in the system when pressed and held for one to two seconds. To enable inverting and charging, press and hold the Standby button again for one to two seconds.



## Using the Standby Button

The Standby button has two functions, depending on how it is pressed. First, when only the Standby button is pressed, it can disable inverting and charging for all Conext SW units in the system. Second, when it is pressed simultaneously with the Exit button, this action puts the entire system into Standby mode.

Pressing the Standby button produces the same result as disabling “Invert” and “AC Charge” from the System Settings menu on the SCP. Pressing the Standby button momentarily affects only Conext SW units; it does not affect charge controller operation. After disabling inverting and charging with the Standby button, the system continues to pass AC input through to the loads.

Pressing the Exit and Standby buttons at the same time puts the entire Xanbus network system (including charge controllers) into Standby mode. In Standby mode, the Conext SW stops passing AC input through to the loads.

After the keypress command to enter Standby mode, the AGS – Automatic Generator Start (if installed) shuts down the generator (if it is running) after a cool-down cycle.

## SCP Navigation

This section describes the different types of screens and menus on the SCP. To monitor Conext SW operation and change settings, it is helpful to know how to locate these screens and menus.

### Startup Screen

This screen is shown when the SCP first receives power from the Xanbus network.

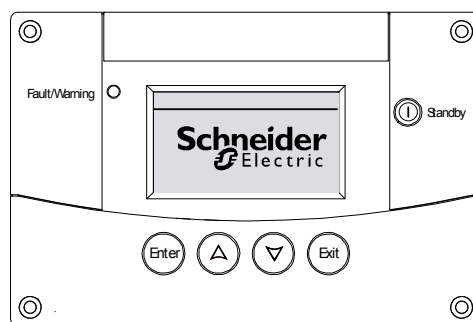

**Figure 3-1** Startup Screen

## Viewing the SCP Home Screens

The top level screens on the SCP are the Startup screen, the System Status screen, and the Device Home screens. After power is applied and the Startup screen appears, the SCP displays the System Status screen. You can view the Device Home screens for the Conext SW and other devices in the system by pressing the up and down arrows, as shown in Figure 3-2.

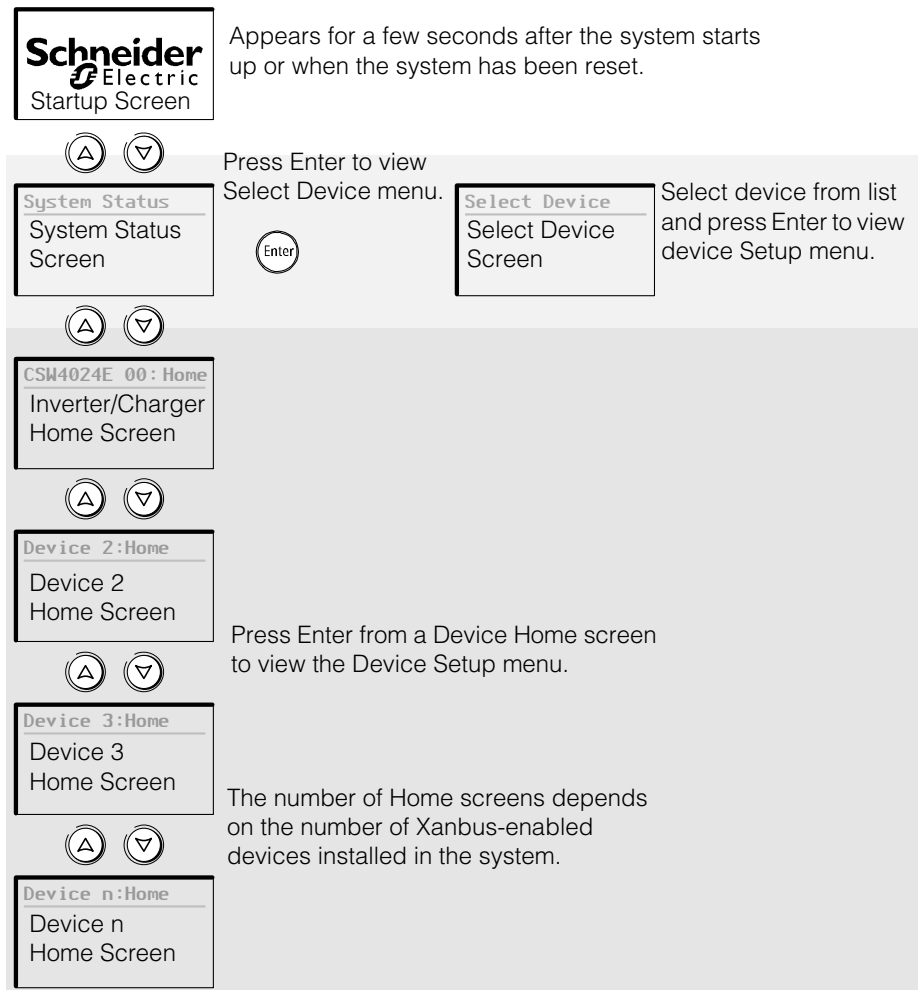

**Figure 3-2** SCP Top Level Screens

### System Status Screen

The **System Status** screen appears after the Startup screen. The **System Status** screen displays aggregated status information for the entire power system. For example, a single system may have three Xanbus network-connected Conext SWs, two MPPT Solar Charge Controllers, one AGS—Automatic Generator Start module, and one SCP—System Control Panel all connected to a single battery bank and a single AC generator.

The System Status screen always features a “Menu” arrow pointing to the Enter button. Pressing Enter takes you to the Select Device menu.

**IMPORTANT:** If you are uncertain which SCP screen or menu you are viewing, you can always return to the starting point—the System Status screen—by pressing Exit repeatedly until the screens stop changing.

The System Status screen displays:

- Qualified AC source (if applicable) and total power to and from the source
- Battery capacity and voltage level
- Net battery input or output current
- Total inverter loading
- Time and date

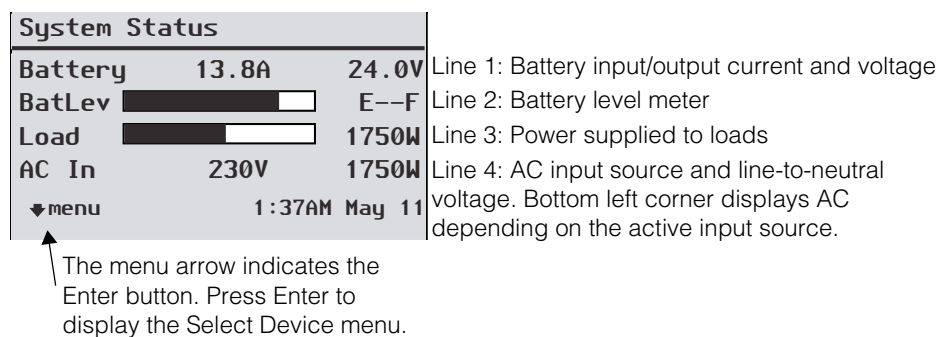

**Figure 3-3** System Status Screen

### Conext SW Home Screen

The Conext SW **Home** screen is the first of the Device **Home** screens. Each Conext SW installed in the system has its own **Home** screen. The screen appearance varies with the status of each inverter/charger. The Conext SW **Home** screen displays real-time operating data specific to the Conext SW. The Conext SW status changes according to the states described in Table 3-2 on page 3-12.

#### To display the Conext SW Home screen:

- ◆ While viewing the **System Status** screen, press the down arrow key.

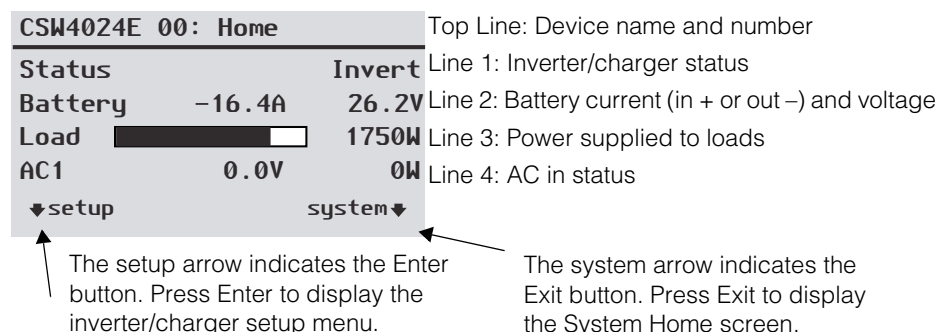

**Figure 3-4** Conext SW Home Screen

Pressing the down arrow button from the Conext SW Home screen displays the Home screens for other Conext SW units and other Xanbus-enabled devices in the system.

**Table 3-2** Conext SW Home Screen States

<b>Conext SW Status</b>	<b>Displayed When...</b>
<b>Invert</b>	The Conext SW is supplying power to loads by inverting power from the batteries. AC input from the AC generator or grid is absent or out of nominal range.
<b>Qualifying AC</b>	The Conext SW is determining if AC input from the AC generator or grid is within a usable voltage and frequency range. It is also displayed when the Conext SW is awaiting application of AC power or a command to enable invert mode.
<b>AC Support</b>	Conext SW powers critical loads by taking power from the battery before any AC source.  See “AC Support Settings” on page 4–23.
<b>Load Shave</b>	There is limited AC input from the AC source and the Conext SW is supporting the AC source by supplying additional power to the critical loads.  See “Load Shaving Setting” on page 4–26.
<b>Bulk</b>	The Conext SW is bulk-charging the batteries from qualified AC input from an AC generator or grid. AC input is also passed through to the load while bulk-charging.
<b>Absorption</b>	The Conext SW is absorption-charging the batteries from qualified AC input from an AC generator or grid. AC input is also passed through to the load while absorption-charging.
<b>ABS Finish</b>	The Conext SW has completed the absorption stage and is waiting for other Conext SWs in the system to complete absorption. This status can occur only when there is another Conext SW also charging the battery.
<b>Equalize</b>	Equalization has been turned on, and the Conext SW is equalizing the batteries after completing a full charge cycle. Equalization time is fixed at 60 minutes.
<b>Float</b>	The Conext SW is float-charging the batteries from qualified AC input from an AC generator or grid. The Conext SW is set for three-stage charging. AC input is also passed through to the load while float-charging.
<b>NoFloat</b>	The Conext SW finishes the absorption stage and the Conext SW is set for two-stage charging.
<b>ACGood</b>	The Conext SW has determined that AC input is within a usable voltage and frequency range.
<b>LdSenseActv</b>	Search Mode is enabled and the Conext SW is standing by waiting to begin inverting. See “Using Search Mode” on page 4–11.
<b>ACCB/ACCA</b>	AC coupling is engaged.

## Viewing Other Screens

This section describes the next level of screens and menus on the SCP.

### Select Device Menu

The **Select Device** menu displays a list of Xanbus-enabled devices in the system, including the Conext SW and the SCP. The **Select Device** menu is where you can access the Setup menus for each device in the system. The length of the **Select Device** menu depends on how many Xanbus-enabled devices are installed.

The **Select Device** menu also contains the **Clock** menu (where the time and date are set) and the **System Settings** menu (where system-level settings can be configured). The **System Settings**, **SCP**, and **Clock** menus are always available from the **Select Device** menu, regardless of the number of Xanbus-enabled devices installed.

#### To display the Select Device menu:

- ◆ While viewing the **System Status** screen, press Enter.

### Device Setup Menus

Device Setup menus display status information (on the Meters screen) and changeable settings. Changeable settings are identified by the square brackets [ ] around values in the right-hand column.

#### To display the Setup menu for a device:

- ◆ Highlight the device name on the **Select Device** menu by using the up and down arrow buttons, and then press Enter on the highlighted device.

-Or-

From the **Home** screen menu, simply press Enter.

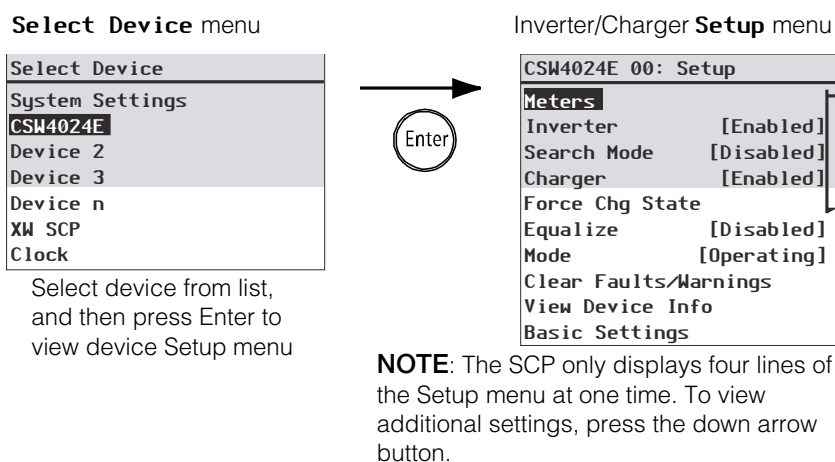

**Figure 3-5** Selecting a Device Setup Menu

When a particular device is selected, it is possible to change its settings and operate the device using the Device Setup menu screen. For more information on how to operate the Conext SW, see “Changing Operational Settings” on page 3–15.

**Meters Screen**

The Meters screen displays total system power production, generator voltage and current status, and load voltage and current status.

**To view the Meters screen:**

- ◆ On the Conext SW **Setup** menu highlight **Meters**, and then press Enter.

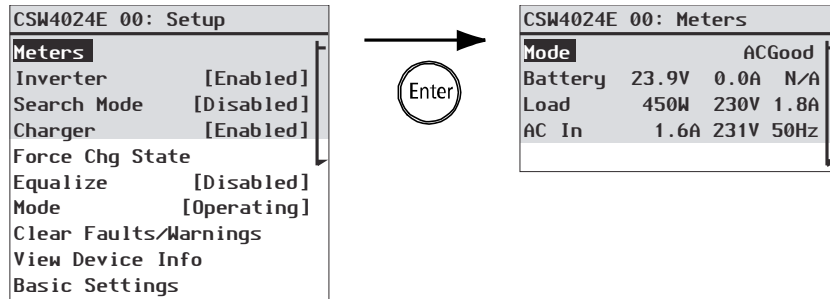

**Figure 3-6** Viewing the Meters Screen

**Table 3-3** Meters Screen

Screen Item	Description
<b>Mode</b>	Operating state of the Conext SW. See also “Conext SW Home Screen States” on page 3–12.
<b>Battery</b>	Displays battery voltage, charging current and battery temperature. The battery temperature comes from the BTS, connected to the Conext SW. If the BTS is not installed, Battery shows as N/A, that is, not available.
<b>Load</b>	Displays power consumption (watts), voltage (volts), and current (amps) supplied to the AC loads.
<b>AC In</b>	AC input current, voltage, and frequency connected to the Conext SW AC INPUT L terminal.

## Changing Operational Settings

The following table shows the various settings you can change to effectively operate the Conext SW inverter/charger.

### To navigate to the Conext SW Setup menu:

- From the **System Status** screen (see 1A), press Enter to view the **Select Device** menu. Go to step 2.  
Or  
From the Conext SW **Home** screen (see 1B), press Enter. The Conext SW **Setup** menu appears.
- Highlight the Conext SW device name, and then press Enter.

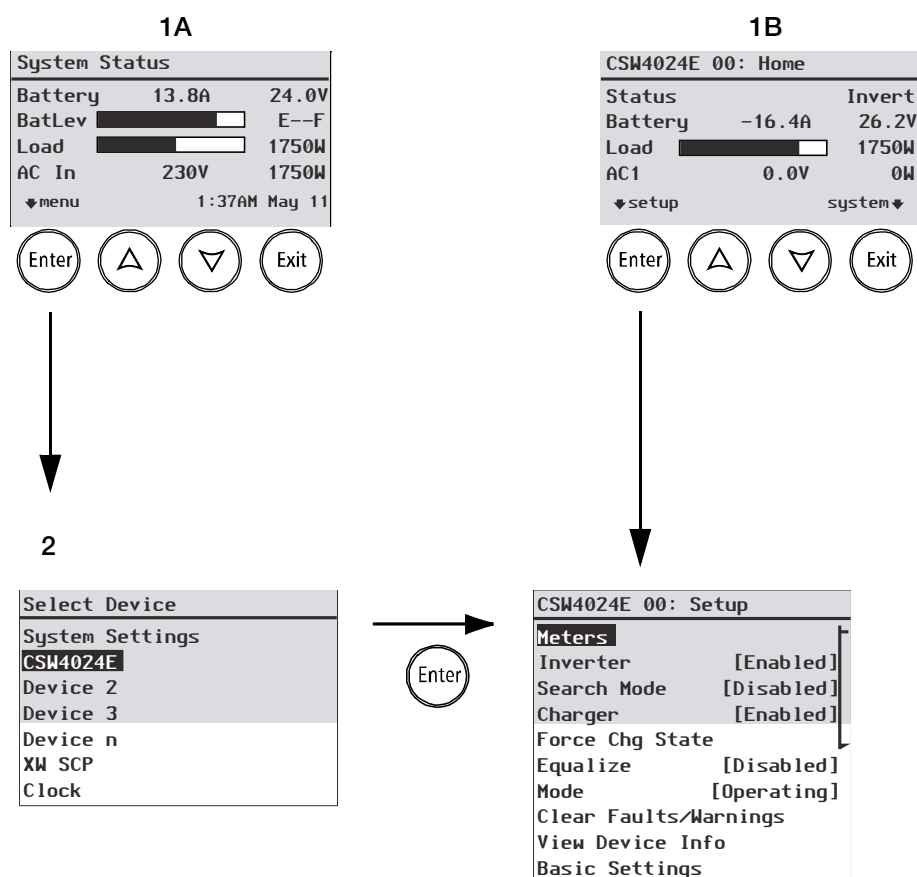

Figure 3-7 Navigate To Conext SW Setup Menu

**Table 3-4** Conext SW Setup menu

Menu Item	Description
<b>Inverter</b>	Enables or disables the inverter. See “To change an operational setting:” on page 3–17.  <b>NOTE:</b> When changing the operational setting for Inverter, remember that enabling the inverter is not the same as the inverter being turned on. An “enabled” inverter can either be on or off, that is inverting or not inverting, respectively. A “disabled” inverter cannot be turned on.
<b>Search Mode</b>	Enables or disables Search Mode. See “To change an operational setting:” on page 3–17. For more information on this setting see “Using Search Mode” on page 4–11.
<b>Charger</b>	Enables or disables the charger. See “To change an operational setting:” on page 3–17.  <b>NOTE:</b> When changing the operational setting for Charger, remember that enabling the charger is not the same as the charger being turned on. An “enabled” charger can either be on or off, that is charging or not charging, respectively. A “disabled” charger cannot be turned on except when the Auto Chg Enable is set to Enabled. See “Charger Settings Menu” on page 4–13 for details.
<b>Force Chg State</b>	Manually changes the charge stage to either Bulk or Float (when 3-Stage cycle is selected) or Bulk or NoFloat (when 2-Stage cycle is selected). See “To change an operational setting:” on page 3–17.
<b>Equalize</b>	Enables or disables battery equalization. See “To change an operational setting:” on page 3–17.
<b>Mode</b>	Selects the Conext SW operating mode: Operating or Standby. The red Standby button on the SCP has similar functionality. See “To change an operational setting:” on page 3–17.
<b>Clear Faults/Warnings</b>	Clears any active faults that were detected or warnings. If the fault detection or warning condition is still present, the fault detection or warning message may reappear. See “To clear fault detections/warnings:” on page 3–17.
<b>View Device Info</b>	Displays the View Device Info logs screen. On the Device Info screen you can view the Warning, fault detection, and Event Logs. See “View Device Info Logs” on page 5–4.
<b>Meters</b>	Displays the Meters screen. See “To view the Meters screen:” on page 3–14.
<b>Basic Settings</b>	Select to display and/or adjust the basic Conext SW settings. See “Configuring Basic Settings” on page 4–7.
<b>Advanced Settings</b>	Select to display and/or adjust the advanced Conext SW settings. See “Configuring Advanced Settings” on page 4–9.



**NOTE:** Meters and View Device Info are not operational settings rather they are informational. Basic and Advanced Settings are covered in another section of the guide.

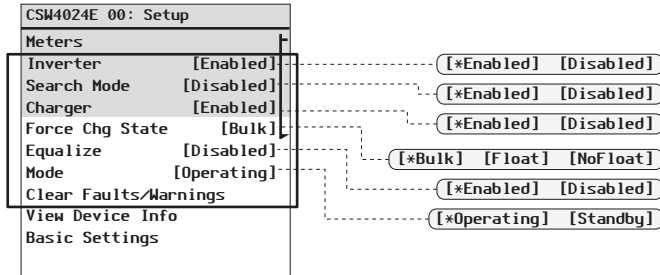

**Figure 3-8** Conext SW Setup Menu Operational Settings

**To change an operational setting:**

1. From the device **Setup** menu screen, use the up or down arrow buttons to highlight any operational setting you wish to change.
2. Press Enter then use the up or down arrow buttons to move between selections. For example, the inverter setting can be changed to either **Enabled** or **Disabled**.
3. Press Enter to confirm the selection.
4. Press Exit (twice) to go back to the **System Status** menu screen.

**To clear fault detections/warnings:**

1. From the device **Setup** menu screen, use the up or down arrow buttons to highlight **Clear Faults/Warnings**.
2. Press Enter to clear the highlighted selection.



# 4

## Configuration via SCP

The following topics will be covered in this chapter.

- Viewing Conext SW's Firmware Version
- Setting System Time and Date
- Viewing Basic and Advanced Settings
- Configuring Basic Settings
- Configuring Advanced Settings

## Viewing the Firmware Revision Number

You may need to view the firmware revision number (**F/W Rev.**) of the Conext SW when troubleshooting the unit with authorized service personnel.

**To view the firmware revision number:**

1. From the **System Status** screen, press the Enter button.  
The **Select Device** menu screen appears.
2. From the **Select Device** screen, press the Enter button.  
The **System Settings** menu screen appears.
3. From the **System Settings** screen, press the down arrow button to highlight **View Device Info** then press Enter.  
The **Device Info** screen appears.
4. Read the displayed information.  
The series of numbers and letters opposite **F/W Rev.** is the firmware revision number.
5. Press Exit (three times) to return to the **System Status** screen.

## Setting the Time and Date

The system time and date are set using the SCP. Time-stamped events such as fault detections and warnings and logged historical data require that the system be set to the correct time.

The SCP has an internal clock that controls the time for all Xanbus-enabled devices in the system. You can set the time, time format, and date on the Clock menu. The Clock menu is accessible on the Select Device menu.

### To set the time and date:

1. From the **System Status** screen, press the Enter button.  
The **Select Device** menu screen appears.
2. From the **Select Device** screen, press the down arrow button to highlight **Clock** then press Enter.  
The **Clock** screen appears and **Set Time** is highlighted.
3. Press Enter and use the up and down arrow buttons to change the hour setting.
4. Press Enter and use the up and down arrow buttons to change the minute setting.
5. Press Enter and use the up and down arrow buttons to select AM or PM.  
This is not applicable if the 12/24 Hour setting is set to 24.
6. Press the down arrow button to highlight **Set Date**.
7. Press Enter and use the up and down arrow buttons to change the month setting.
8. Press Enter and use the up and down arrow buttons to change the day setting.
9. Press Enter and use the up and down arrow buttons to change the year setting.
10. Press Enter to confirm the changes.
11. Press Exit (twice) to return to the **System Status** screen.

## Viewing the Basic and Advanced Settings Menus

### Basic Settings menu

The Conext SW configuration settings can be viewed in Basic and Advanced formats. The Basic Settings include configuration items you may have to adjust routinely or as part of initial setup. The Basic Settings option appears by default on the Setup menu screen.

The Conext SW Basic settings include menus for configuring:

- Battery type setting (see page 4-7).
- Battery capacity setting (see page 4-7).
- Maximum charging rate setting (see page 4-7).
- Charging cycle setting (see page 4-7).
- Charging volts setting (see page 4-7)
- AC priority setting (see page 4-7).
- AC Breaker settings (see page 4-7).
- Low battery cutout setting (see page 4-7).

#### To view the Basic Settings menu:

- ◆ From the Setup menu, scroll to the bottom of the screen to highlight Basic Settings and press Enter. See Figure 4-2.

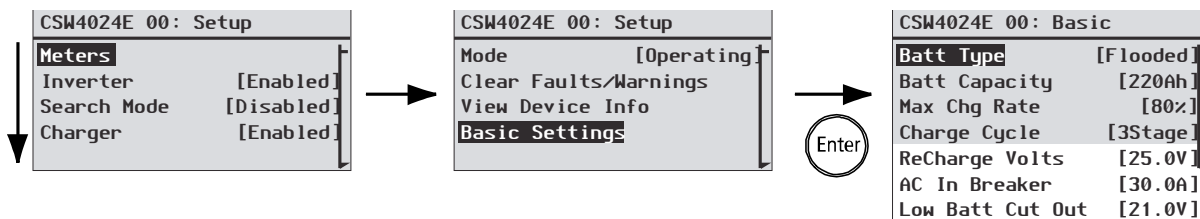

Figure 4-1 Selecting Basic Settings

#### To select and change a configurable setting:

1. On the desired configuration menu, press the up arrow or down arrow button to highlight the setting you want to change.
2. Press Enter to highlight the current value of the setting.
3. Press the up arrow or the down arrow button to change the value. Hold down the button to scroll through a large range of values quickly.  
The previously set value appears with an asterisk (\*) beside it.
4. Press Enter to select the value.
5. If you have another setting to change, return to step 1.

Or

If you have no more settings to change, press Exit until the SCP displays the desired screen or menu.

**Advanced Settings menu**

The Advanced Settings option gives you access to the full range of Conext SW settings, including everything displayed on the Basic menu. As a safeguard against unintended Advanced configuration, the SCP displays the Basic settings by default. To view the Advanced settings, you must perform a special keypress.

**NOTICE****EQUIPMENT DAMAGE**

The advanced settings are intended for qualified installation/service personnel only. Before changing advanced settings, you must be familiar with the settings and the system-wide impact of changing those settings. Setting parameters incorrectly could damage connected equipment (such as batteries) or could severely affect the performance of your system. Incorrect charging configuration can lead to battery damage.

**Failure to follow these instructions can result in equipment damage.**

**To select the Advanced Settings menu:**

1. On the **Select Device** menu, select a Conext SW device.
2. Press Enter. The **Setup** menu screen appears.
3. Press Enter + up arrow + down arrow at the same time.

**NOTES:**

- This keypress (Enter + up arrow + down arrow) enables the Advanced settings for every device in the system.
- After performing the keypress, "Advanced Settings" appears at the top of the Setup menu (see Figure 4-2). When the keypress is performed again, the Setup menu displays "Basic Settings" as the last item on the menu (see Figure 4-1).

The Conext SW Advanced settings include menus for configuring:

- Inverter settings (see page 4-9).
- Charger settings (see page 4-13).
- AC transfer limit settings (see page 4-22).
- AC support settings (see page 4-23).
- Multiple unit operation, including customizing the default model name of the inverter/charger and setting its network device number. Setting the device number is important when multiple Conext SW units are on the Xanbus network and sharing connections such as AC loads and AC generator. The device number is also used when configuring paralleled Conext SW units for master-slave operation (see page 4-29).

Additionally, from Conext SW Advanced settings, you can:

- Restore factory defaults
- Access other advanced features

**To view the Advanced Settings menu:**

- ◆ From the Setup menu, with Basic Settings or Advanced Settings highlighted, press Enter. See Figure 4-2.

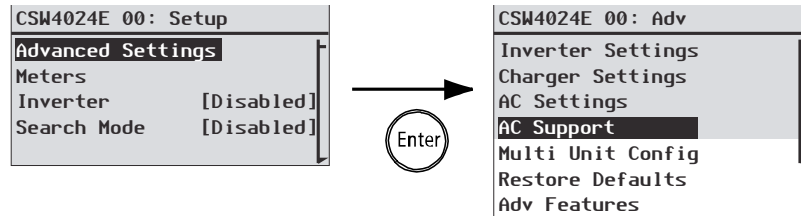

**Figure 4-2** Selecting Advanced Settings

**To select and change a configurable setting:**

1. On the desired configuration menu, press the up arrow or down arrow button to highlight the setting you want to change.
2. Press Enter to highlight the current value of the setting.
3. Press the up arrow or the down arrow button to change the value. Hold down the button to scroll through a large range of values quickly.  
The previously set value appears with an asterisk (\*) beside it.
4. Press Enter to select the value.
5. If you have another setting to change, return to step 1.

Or

If you have no more settings to change, press Exit until the SCP displays the desired screen or menu.

---

**IMPORTANT:** If you have no more settings to change, it is recommended to leave the **Setup** menu in the Basic Settings format to help prevent unintended configuration. If the **Setup** menu displays “Advanced Settings,” press Enter + up arrow + down arrow at the same time. The **Setup** menu should then display **Basic Settings** as the last item on the menu.

---



# Configuring Basic Settings

An overview of the Conext SW Basic Settings menu structure is shown below.

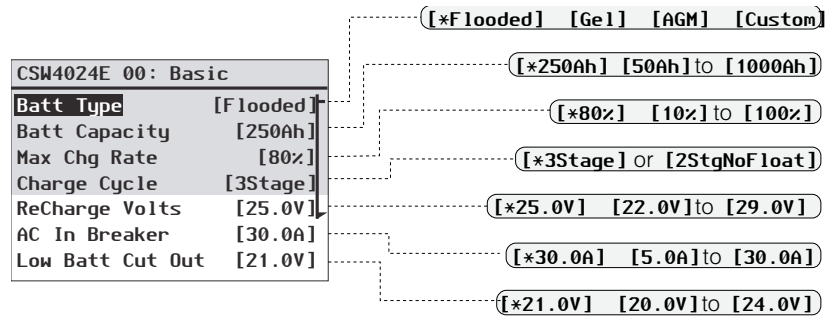

Follow procedures on “To select and change a configurable setting:” on page 4-4 to change the settings.

**Figure 4-3** Menu Map of the Conext SW Basic Settings

**Table 4-1** Setting Defaults and Ranges

Model	24-volt Models			48-volt Model		
	Default	Min	Max	Default	Min	Max
Batt Type	Flooded	Flooded, Gel, AGM, Custom		Flooded	Flooded, Gel, AGM, Custom	
Batt Capacity	250Ah	50Ah	100Ah	250Ah	50Ah	1000Ah
Max Chg Rate	100%	10%	100%	100%	10%	100%
Charge Cycle	3Stage	3Stage, 2StgNoFloat		3Stage	3Stage, 2StgNoFloat	
ReCharge Volts	25.0V	22.0V	29.0V	50.0V	44.0V	58.0V
AC In Breaker	30A	5A	30A	30A	5A	30A
Low Batt Cut Out	21.0V	20.0V	24.0V	42.0V	40.0V	48.0V

**Table 4-2** Basic Settings

Item	Description
Batt Type	Sets the system battery chemistry and type: <b>Flooded</b> , <b>AGM</b> , <b>Gel</b> , and <b>Custom</b> .  Selecting <b>Custom</b> displays the <b>Custom Settings</b> item, which allows you to adjust the settings for each charging stage.
Batt Capacity	Selects the system battery capacity in amp hours.

**Table 4-2** Basic Settings

<b>Max Chg Rate</b>	<p>Sets the percentage of the maximum DC output current that is available to the charger. The maximum DC output current for different models is:</p> <p>SW 2524 230 — 65 ADC</p> <p>SW 4024 230 — 90 ADC</p> <p>SW 4048 230 — 45 ADC</p> <p>If multiple Conext SWs are charging the same battery bank, set each inverter's <b>Max Chg Rate</b> to 1/n of the desired charge rate (where n is the number of inverter/chargers).</p>
<b>Charge Cycle</b>	<p>Sets the charging method: <b>3-Stage</b> (bulk, absorption, float) or <b>2StgNoFloat</b> (bulk, absorption, no float).</p>
<b>ReCharge Volts</b>	<p>Sets the recharging volts to tell the charger to initiate charging when the battery drains past the value setting.</p>
<b>AC In Breaker</b>	<p>Sets the breaker limit of incoming AC (generator or grid).</p>
<b>Low Batt Cut Out</b>	<p>Low Battery Cut Out (LBCO) controls when the inverter stops producing AC output due to a low battery voltage condition. The inverter will stop producing AC output only after this level has been reached for the period of time set by the <b>LBCO Delay</b>. This setting is not temperature compensated.</p>

# Configuring Advanced Settings

**NOTICE**

**RISK OF DAMAGE TO CONNECTED DEVICES**

The advanced settings are intended for qualified installation/service personnel only. Before changing advanced settings, you must be familiar with the settings and the system-wide impact of changing those settings. Setting parameters incorrectly could damage connected equipment (such as batteries) or could severely affect the performance of your system. Incorrect charging configuration can lead to battery damage.

**Failure to follow these instructions can result in equipment damage.**

## Inverter Settings Menu

The **Inverter Settings** menu contains settings that control when the Conext SW starts and stops producing AC output.

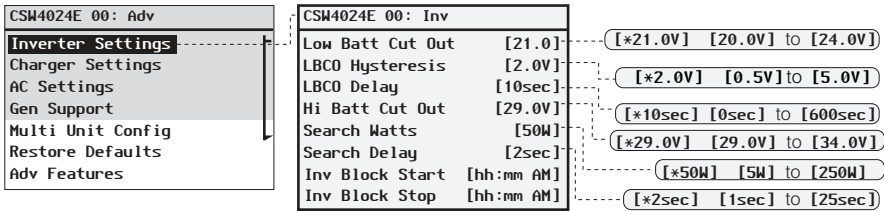

Follow procedures on “To select and change a configurable setting:” on page 4–6 to change the settings.

Figure 4-4 Inverter Settings Menu Screen

Table 4-3 Setting Defaults and Ranges

Model	24-volt Models			48-volt Model		
	Default	Min	Max	Default	Min	Max
Low Batt Cut Out	21.0V	20.0V	24.0V	42.0V	40.0V	48.0V
LBCO Hysteresis	2.0V	0.5V	5.0V	2.0V	0.5V	5.0V
LBCO Delay	10sec	0sec	600sec	10sec	0sec	600sec
Hi Batt Cut Out	29.0V	29.0V	34.0V	68.0V	58.0V	68.0V
Search Watts	50W	5W	250W	50W	5W	250W
Search Delay	2sec	1sec	25sec	2sec	1sec	25sec
Inv Block Start	12:00AM	n/a		12:00AM	n/a	
Inv Block Stop	12:00AM	n/a		12:00AM	n/a	

**Table 4-4** Inverter Settings Description

Item	Description
<b>Low Batt Cut Out</b>	Same description as “Basic Settings” on page 4–7.
<b>LBCO Hysteresis</b>	See “Low Battery Cut Out Hysteresis” on page 4–11.
<b>LBCO Delay</b>	<p>LBCO Delay controls how long the inverter is allowed to operate at or below the <b>Low Batt Cut Out</b> level before turning off due to a low battery voltage condition. The inverter will stop producing AC output only after the <b>Low Batt Cut Out</b> level has been reached for this uninterrupted period of time.</p> <p>Once the inverter has shut off, the battery voltage must rise 2 volts above the <b>Low Batt Cut Out</b> setting for inverter operation to resume.</p>
<b>Hi Batt Cut Out</b>	<p>Hi Batt Cut Out sets the maximum battery voltage at which the inverter will operate. If the battery voltage exceeds this limit for more than one minute, the Conext SW displays a fault message and shuts down. The inverter will not support AC loads when in this condition. If a qualified AC source is present, the unit passes AC through to the loads. The inverter automatically restarts when the voltage drops to 3 volts below the <b>Hi Batt Cut Out</b> setting. If battery voltage continues to rise after shutdown, an external charger may still be charging the batteries. The Conext SW cannot control how external chargers operate.</p>
<b>Search Watts</b>	<p>Search Watts sets the Conext SW’s search sensitivity when search mode is enabled. When a load larger than this setting is present, the inverter starts producing AC output. Enabling search mode from the <b>Setup</b> menu can minimize power draw from the battery during periods of low demand from loads. Also see “Using Search Mode” on page 4–11.</p>
<b>Search Delay</b>	<p>Search Delay sets the time between search pulses. When searching for loads, the Conext SW sends out search pulses to determine if a load is present. If the Conext SW finds a load above the <b>Search Watts</b> setting, the inverter turns on. Conext SW power draw while in search mode decreases when <b>Search Delay</b> is increased, but the Conext SW’s response time to active loads is slower.</p>
<b>Inv Block Start</b>	<p>Sets the time to halt inverting. See “Using Inverter Block” on page 4–12 for more information.</p>
<b>Inv Block Stop</b>	<p>Sets the time to resume inverting. See “Using Inverter Block” on page 4–12 for more information.</p>

## Using the Low Battery Cut Out and LBCO Delay Settings

The Low Batt Cut Out setting is the lowest battery voltage level acceptable for use by the inverter. When the batteries discharge to the Low Batt Cut Out setting and are held at or below this level for the LBCO Delay time, the inverter output shuts down and transfers any available AC source (like an AC generator) to the charger to bring the battery level back above the Low Batt Cut Out setting. After shutdown, the inverter does not support any AC loads, and AC loads must be powered by an AC generator.

If using an automatic generator starting system, it is recommended to set the Xanbus AGS voltage trigger setting higher than the Conext SW Low Batt Cut Out voltage. Otherwise, inverter output turns off before the generator automatically starts, causing the battery voltage to recover slightly. This may then stop the Xanbus AGS from starting the generator or result in the inverter cycling on and off multiple times before the generator automatically starts.

If using an automatic generator starting system with the start trigger set to the same voltage as the LBCO voltage, do not set the LBCO Delay for less than the amount of time it takes the generator to start and connect. Otherwise, inverter output turns off before the generator automatically starts, causing the battery voltage to recover slightly. This may then stop the Xanbus AGS from starting the generator or result in the inverter cycling on and off multiple times before the generator automatically starts.

## Low Battery Cut Out Hysteresis

Low battery cut out (**Low Batt Cut Out**) (LBCO) preserves battery life by stopping the inverter when battery voltage drops down to the LBCO value for a few seconds then battery charging commences. When charging starts, the voltage level jumps a little but enough that inverting might resume abruptly. Then, battery voltage goes down again and charging starts abruptly. To prevent the inverter from switching abruptly between inverting and charging, the **LBCO Hysteresis** value is added to the LBCO value to allow the battery voltage to reach a sufficient energy capacity level before inverting resumes. This feature contributes to battery health.

## Using Search Mode

### Why use Search mode?

Search mode allows the inverter to selectively power only items that draw more than a certain amount of power, which can result in power savings.

The Conext SW has a no-load power draw of about 38 W (SW 2524 230) and 40 W (SW 4024 230). Enabling Search mode reduces this power draw to less than 8 W for all models.

Search mode operates differently in single-unit and multiple unit installations.

### Single units

When a single Conext SW has Search mode enabled, the inverter sends electrical search pulses through its AC output. These search pulses search for connected AC loads. The delay between search pulses is set using the Search Delay setting.

After a load larger than the Search Watts setting is detected, the inverter turns on.

<b>Multiple units</b>	Search mode is automatically enabled in multiple unit installations with two paralleled Conext SW units. Only the master Conext SW operates, and the slave unit comes online only when the load exceeds approximately 60% of the rated output of the master unit. When the load drops below 20% of the master's rated output, the slave unit turns off.
<b>When to set up Search mode</b>	<p>The Search mode feature is only valuable if the inverter can spend a couple of hours “sleeping” each day. Therefore, if Search mode is to be used it must be adjusted properly. The initial adjustment should be made so that the inverter comes on only when needed.</p> <p>Certain types of loads can cause Search mode not to work as expected. These types of loads are described on “Problem Loads” on page 5–3 of the Troubleshooting chapter. If these kinds of loads are in the system, follow the suggestions given to eliminate the problem. If the problem loads cannot be eliminated, there are two work-around solutions:</p> <ol style="list-style-type: none"><li>1. Disable <b>Search Mode</b> from the main Conext SW <b>Setup</b> menu, causing the inverter to always remain at full output voltage.</li><li>2. Use a search-friendly companion load whose only purpose is to be switched on to wake up the inverter to power the load that is unable to bring the inverter out of Search mode.</li></ol>

---

**NOTES:**

- Search mode, by function, cannot work with clocks and timers or devices that need power 24 hours a day. Examples of devices with timers include video recorders, coffee makers with brew timers, refrigerators, and freezers with defrost timers. Examples of devices that need power 24 hours a day include telephone answering machines, alarm systems, motion detection lights, and some thermostats.
  - When the inverter is searching the output for loads, lights that have a wattage lower than this setting may flash momentarily.
- 

## Using Inverter Block

The Inverter Block feature halts inverter function for a period of time each day. This period of time is defined by the **Inv Block Start** and **Inv Block Stop** settings. Inverter Block allows you to control which time period is not ideal for inverting. This can be a time period when conserving battery power is more important than running loads.

The **Inverter** setting must be initially **Enabled** in order for the Inverter Block to work as intended. The **Inv Block Start** setting disables inverter function if the inverter is initially enabled and then **Inv Block Stop** enables the inverter function. However, if the **Inverter** setting is initially **Disabled** when **Inv Block Start** commences, then the succeeding **Inv Block Stop** will not enable inverter function automatically. The inverter will remain disabled.

Setting the **Inv Block Start** and **Inv Block Stop** to the same time disables Inverter Block. Disabling Inverter Block means that inverting is allowed to occur at any time when the right conditions for inverting exist.

**NOTE:** In a multiple unit configuration, set the same Inverter Block settings to both the master and slave units.

### Charger Settings Menu

The **Charger Settings** menu provides options for configuring the Conext SW to operate from your battery bank.

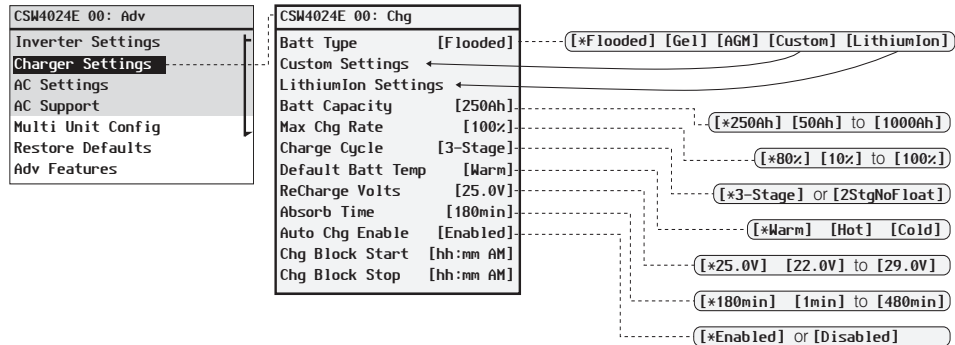

Follow procedures on “To select and change a configurable setting:” on page 4-6 to change the settings.

Figure 4-5 Charger Settings Menu Screen

Table 4-5 Setting Defaults and Ranges

Model	24-volt Models			48-volt Model		
Item	Default	Min	Max	Default	Min	Max
<b>Batt Type</b>	Flooded	Flooded, Gel, AGM, Custom, LithiumIon		Flooded	Flooded, Gel, AGM, Custom, LithiumIon	
<b>Custom Settings</b>	See page 4-19.			See page 4-19.		
<b>LithiumIon Settings</b>	See page 4-19.			See page 4-19.		
<b>Batt Capacity</b>	See page 4-7.			See page 4-7.		
<b>Max Chg Rate</b>	100%	10%	100%	100%	10%	100%
<b>Charge Cycle</b>	3Stage	3Stage, 2StgNoFloat		3Stage	3Stage, 2StgNoFloat	
<b>Default Batt Temp</b>	Warm	Hot, Warm, Cold		Warm	Hot, Warm, Cold	

**Table 4-5** Setting Defaults and Ranges

Model	24-volt Models			48-volt Model		
Item	Default	Min	Max	Default	Min	Max
ReCharge Volts	25.0V	22.0V	29.0	50.0V	44.0V	58.0V
Absorb Time	180min	1min	480min	180min	1min	480min
Auto Chg Enable	Enabled	Enabled, Disabled		Disabled	Enabled, Disabled	
Chg Block Start	12:00AM	n/a		12:00AM	n/a	
Chg Block Stop	12:00AM	n/a		12:00AM	n/a	

**Table 4-6** Charger Settings Menu Description

Item	Description
<b>Batt Type</b>	Sets the system battery chemistry and type: <b>Flooded</b> , <b>AGM</b> , <b>Gel</b> , <b>Custom</b> , and <b>LithiumIon</b> .  Selecting <b>Custom</b> displays the <b>Custom Settings</b> item, which allows you to adjust the settings for each charging stage. Selecting <b>LithiumIon</b> displays the <b>LithiumIon Settings</b> item, which allows you to adjust the settings for each charging stage.
<b>Custom Settings</b>	See page 4–19.
<b>LithiumIon Settings</b>	See page 4–19.
<b>Batt Capacity</b>	See page 4–7.
<b>Max Chg Rate</b>	Same description as “Basic Settings” on page 4–7.
<b>Charge Cycle</b>	Sets the charging method: <b>3Stage</b> (bulk, absorption, float) or <b>2StgNoFloat</b> (bulk and absorption only, no float).
<b>Default Batt Temp</b>	Selects the battery temperature charging compensation if a battery temperature sensor is not installed. In the absence of a battery temperature sensor, the charger uses one of three settings: <b>Cold</b> (10 °C), <b>Warm</b> (25 °C), or <b>Hot</b> (40 °C).
<b>ReCharge Volts</b>	Sets the recharging volts to tell the charger to initiate charging when the battery drains past the value setting.
<b>Absorb Time</b>	Sets the maximum time spent in the absorption stage, before transitioning to float or no float.



**Table 4-6** Charger Settings Menu Description

Item	Description
<b>Auto Charge Enable</b>	When this setting is enabled, it overrides the “Charger” function to begin charging automatically when qualified AC is present. This happens even when the charger function is previously disabled.
<b>Chg Block Start</b>	Sets the time to halt charging. See “Using Charger Block” on page 4–18 for more information.
<b>Chg Block Stop</b>	Sets the time to resume charging. See “Using Charger Block” on page 4–18 for more information.

## Battery Charger Functions

When AC power is available, the Conext SW can operate as a battery charger. Different battery types and chemistries require different charging voltage levels. Not charging batteries at the required levels can shorten battery life or damage the batteries. The Conext SW is configured at the factory to work with the battery types recommended for inverter applications. If the default settings do not work for your specific installation, you can adjust the charge stage settings (as recommended by the battery manufacturer) on the **Custom (Battery) Settings** menu (see page 4–19).

---

**IMPORTANT:** This information is provided for guidance only. Variations in battery chemistry and site-specific environmental considerations mean that you should consult your system designer or battery manufacturer for specific recommendations for appropriate battery voltage and current settings.

---

## Multi-Stage Charging Process

The charging cycle is a multi-stage process. Whenever qualified AC power is present at the inverter’s input, it passes power through to the connected load and begins charging the batteries.

---

**NOTE:** If the AC input fails or drops below the lower VAC limit (as set in AC Settings), the complete multi-stage charge cycle (Bulk, Absorption, Float/No Float) restarts once the source AC returns to within tolerance condition. If the batteries are already nearly full, the charge cycle will take little time to complete.

---

### Bulk Stage

Bulk charge is the first stage in the charging process and provides the batteries with a controlled, constant current. Once the battery voltage rises to the bulk voltage threshold, the charger switches to the Absorption stage.

**Table 4-7** Preset Bulk Voltage Settings for Different Battery Types

Battery Type	24-Volt Models Preset Bulk Voltage	48-Volt Model Preset Bulk Voltage
Flooded	28.8V	57.6V
Gel	28.4V	56.8V

**Table 4-7** Preset Bulk Voltage Settings for Different Battery Types

Battery Type	24-Volt Models Preset Bulk Voltage	48-Volt Model Preset Bulk Voltage
<b>AGM</b>	<b>28.6V</b>	<b>57.2V</b>
<b>Custom</b>	<b>28.8V</b> (changeable)	<b>57.6V</b> (changeable)
<b>LithiumIon</b>	<b>29.0V</b> (changeable)	<b>58.0V</b> (changeable)

**Absorption Stage**

Absorption charge is the second stage of battery charging and provides the batteries with a controlled, constant voltage. During this stage, the current drawn by the batteries slowly decreases. When this current falls below 2% of the battery capacity, or when the configurable Absorb Time expires, the charger switches to the Float or NoFloat stage, depending on the selected charge cycle.

**NOTE:** If there are DC loads on the batteries, the charger’s current may never decrease to a level to initiate the next stage of charging. In this case, the charger would stay in absorption until the Absorb Time setting is reached.

To make sure the charger does not remain in absorption for too long, adjust Absorb Time on the Charger Settings menu. The timer begins at the start of the absorption stage and terminates absorption charging if the charge current does not decrease to below 2% of the battery capacity before the Absorb Time setting expires. The Absorb Time setting may be increased if the charge cycle continually runs the full Absorb Time in the absence of DC loads. This is an indication of too large a battery bank for the selected Absorb Time setting.

**Table 4-8** Preset Absorption Voltage Settings for Different Battery Types

Battery Type	24-Volt Models Preset Absorption Voltage	48-Volt Model Preset Absorption Voltage
<b>Flooded</b>	<b>28.8V</b>	<b>57.6V</b>
<b>Gel</b>	<b>28.4V</b>	<b>56.8V</b>
<b>AGM</b>	<b>28.6V</b>	<b>57.2V</b>
<b>Custom</b>	<b>28.8V</b> (changeable)	<b>57.6V</b> (changeable)
<b>LithiumIon</b>	<b>29.0V</b> (changeable)	<b>58.0V</b> (changeable)

**Float Stage**

Float charge maintains a trickle charge on the batteries whenever AC is present on the Conext SW input. Float charging reduces battery gassing, minimizes watering requirements (for flooded batteries), and makes sure the batteries are in a constant state of readiness. When three-stage charging is selected, the charger automatically switches to the float stage after the batteries have received a bulk and absorption charge. The batteries will be maintained at the default float voltage level for the selected battery type or the voltage selected under Float Voltage on the custom battery Settings menu.

**NOTE:** The battery voltage can increase above the float voltage when using an external charging device such as PV arrays, wind turbines, or micro-hydro generators. Be sure to include appropriate charge management equipment with all external DC sources.

**Table 4-9** Preset Float Voltage Settings for Different Battery Types

Battery Type	24-Volt Models Preset Float Voltage	48-Volt Model Preset Float Voltage
<b>Flooded</b>	<b>27.0V</b>	<b>54.0V</b>
<b>Ge1</b>	<b>27.6V</b>	<b>55.20V</b>
<b>AGM</b>	<b>26.8V</b>	<b>53.6V</b>
<b>Custom</b>	<b>27.0V</b> (changeable)	<b>54.0V</b> (changeable)
<b>LithiumIon</b>	<b>26.85V</b> (changeable)	<b>53.6V</b> (changeable)

**Two-Stage**

Two-stage (bulk and absorption only, no float) mode differs from an ordinary three-stage charge mode in that it does not continuously maintain the battery at float voltage. Instead, the Conext SW begins charging the battery in bulk mode whenever the battery voltage drops below the recharge level. While the battery voltage is above the recharge level, the inverter continues to pass power through from the AC source to the loads but does not actively charge the batteries.

**Equalize-Charging the Batteries**

Many battery manufacturers recommend periodic equalize charging to level out the voltage between individual cells, improving battery performance and lifespan.

Over time, the battery's electrolyte can become stratified, causing inactive areas in the plate material. If this condition is allowed to continue for extended periods, the battery plates can sulfate and become unusable. Equalizing the batteries is a controlled overcharging method that mixes up the electrolyte and reactivates the unused areas of the plate material, restoring batteries to a full state of charge.

Consult the battery manufacturer's recommendation for equalize voltage settings.

Equalization time is fixed at 60 minutes.

**Table 4-10** Preset Equalization Voltage Settings for Different Battery Types

Battery Type	24-Volt Models Preset Equalization Voltage	48-Volt Model Preset Equalization Voltage
<b>Flooded</b>	<b>32.0V</b>	<b>64.0V</b>
<b>Ge1</b>	not applicable	not applicable
<b>AGM</b>	not applicable	not applicable
<b>Custom</b>	<b>32.0V</b> (changeable)	<b>64.0V</b> (changeable)
<b>LithiumIon</b>	not applicable	not applicable

**To start equalizing the batteries:**

- ◆ On the device **Setup** menu, highlight **Equalize** and select **Enabled**.

---

**NOTE:** Only flooded or vented batteries should be equalize-charged. Hydrogen and oxygen gases are produced when batteries are equalize-charged. See warning below.

---

**⚠ WARNING**

**EXPLOSION HAZARD**

Provide adequate ventilation for the battery and remove all sources of ignition to reduce the risk of explosion.

**Failure to follow these instructions can result in death or serious injury.**

---

**IMPORTANT:** In a system where more than one device is capable of equalizing batteries (such as a system including multiple Conext SW units and Solar Charge Controllers), there is no system-wide equalization command for all devices. To equalize with multiple devices, each would have to be enabled individually. Alternatively, equalization can be performed using only one device. During the equalization process, one device applies the equalization charge while the other devices continue to operate in synchronized charge mode, typically in float (three-stage charging) or no-float (two-stage charging).

---

## Using Charger Block

The Charger Block feature halts charging for a period of time each day. This period of time is defined by the **Chg Block Start** and **Chg Block Stop** settings. In areas where the utility charges variable rates for electricity, it is preferable to use utility power for charging only during non-peak hours. Charger Block can prevent utility power from being used for battery charging during peak billing periods. During the time period set between **Chg Block Start** and **Chg Block Stop**, AC input continues to be passed through to the loads. Inverter operation remains unaffected during the charger block period. During the Charger Block period, no charging occurs even if the batteries discharge below the **ReCharge Volts** setting. However, a Solar Charge Controller may charge batteries during the Charger Block period.

If the charger is operating (that is, in Float, Absorption, Bulk, or Equalize stage) at the **Chg Block Start** time, charging stops immediately and the charger enters an idle state identical to No Float (see “Two-Stage” on page 4–17). When the Charger Block period is over, the charger does not resume the charge stage that **Chg Block Start** interrupted. Instead, if the batteries are above the **ReCharge Volts** setting, the charger remains idle. If the battery voltage falls below the **ReCharge Volts** setting during the Charger Block period, the Conext SW Inverter/Charger begins a new charge cycle with the Bulk stage after the Charger Block period has expired (at the **Chg Block Stop** time).

Setting the **Chg Block Start** and **Chg Block Stop** to the same time disables Charger Block. Disabling Charger Block means that charging is allowed to occur at any time when the right conditions for charging exist.

## Custom Battery Settings Menu

**NOTICE**

**EQUIPMENT DAMAGE**

Consult your battery manufacturer and associated documentation before setting a custom battery type and before battery charging or equalization.

**Failure to follow this instruction may cause damage to the battery.**

Custom Settings appears only when Batt Type is set to Custom.

CSW4024E 00: Chg	
Batt Type	[Custom]
Custom Settings	-----
Batt Capacity	[220Ah]
Max Chg Rate	[100%]
Charge Cycle	[3-Stage]

CSW4024E 00: Cust	
Eqlz Support	[Enabled]
Eqlz Voltage	[32.0V]
Bulk Voltage	[28.8V]
Absorb Voltage	[28.8V]
Float Voltage	[27.0V]
BattTempComp	[-54mV/C]

Eqlz Voltage appears only when Eqlz Support is Enabled.

Follow procedures on “To select and change a configurable setting:” on page 4–6 to change the settings.

**Figure 4-6** Custom Settings Menu Screen

**Table 4-11** Setting Defaults and Ranges

Model	24-volt Models			48-volt Model		
Item	Default	Min	Max	Default	Min	Max
<b>Eqlz Support</b>	Enabled	Enabled, Disabled		Enabled	Enabled, Disabled	
<b>Eqlz Voltage</b>	32.0V	27.0V	32.0V	62.0V	54.0V	64.0V
<b>Bulk Voltage</b>	28.8V	27.2V	32.0V	57.6V	54.2V	64.0V
<b>Absorb Voltage</b>	28.8V	24.0V	32.0V	57.6V	40.0V	64.0V
<b>Float Voltage</b>	27.0V	22.0V	32.0V	54.0V	50.0V	64.0V
<b>Batt Temp Comp</b>	-54mV/C	-0mV/C	-90mV/C	-108mV/C	-0mV/C	-108mV/C

The **Custom Battery Settings** menu can be viewed if **Custom** is selected as the **Batt Type**. This menu allows you to adjust charging and equalization voltage for batteries with specifications that fall outside the default settings for the battery types the Conext SW offers. You can also adjust the temperature compensation constant for the battery temperature sensor on this menu.

**IMPORTANT:** All settings for configuring a custom battery type are based on the default settings for a flooded battery type.

**Table 4-12** Custom Battery Settings Menu Description

Item	Description
<b>Eqlz Support</b>	Enables or disables the ability to enter an equalization cycle. Refer to the battery manufacturer's specifications to determine whether equalization is recommended.
<b>Eqlz Voltage<sup>a</sup></b>	Selects the equalization voltage. Consult your battery manufacturer for equalization voltage setting.
<b>Bulk Voltage</b>	Sets the bulk voltage for a custom battery type. See note below.
<b>Absorb Voltage</b>	Sets the absorption voltage for a custom battery type.
<b>Float Voltage</b>	Sets the float voltage for a custom battery type. See note below.
<b>Batt Temp Comp</b>	Battery temperature compensation for a custom battery type. This setting is the coefficient that the BTS uses to adjust the charging voltage when the temperature is above or below 25 °C.

a. The **Eqlz Voltage** setting is displayed when **Eqlz Support** is set to **Enabled**.

**NOTE:** If a warning is received indicating that a setting is not accepted by the SCP, gradually increase the value of the setting until the SCP accepts it. This type of warning means that an internal minimum threshold value is being crossed and therefore the setting cannot be saved.

## LithiumIon Battery Settings Menu

<b>⚠ WARNING</b>
<p><b>BATTERY TYPE HAZARD</b></p> <p>When using Lithium Ion batteries, ensure that the battery pack being used includes a Battery Management System (BMS) with safety controls.</p> <p><b>Failure to follow this instruction can result in property damage, death or serious injury.</b></p>

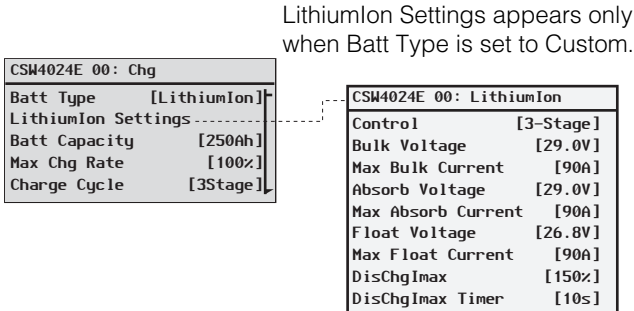

Follow procedures on “To select and change a configurable setting:” on page 4–6 to change the settings.

Figure 4-7 LithiumIon Settings Menu Screen

Table 4-13 Setting Defaults and Ranges

Model	24-Volt Models			48-Volt Model		
Item	Default	Min	Max	Default	Min	Max
Control	3-Stage	Ext BMS, 2-Stage, 3-Stage		3-Stage	Ext BMS, 2-Stage, 3-Stage	
Bulk Voltage	29.0V	28.2V	32.5V	58.0V	56.2V	65.0V
Max Bulk Current	90A	15A	90A	45A	10A	45A
Absorb Voltage	29.0V	20.0V	32.5V	58.0V	40.0V	65.0V
Max Absorb Current	90A	15A	90A	45A	10A	45A
Float Voltage	26.8V	23.6V	32.0V	53.6V	47.2V	64.0V
Max Float Current	90A	1A	90A	45A	1A	45A
DisChgImax	150%	20%	500%	150%	20%	500%
DisChgImax Timer	10s	1S	300s	10s	1s	300s

The **LithiumIon Settings** menu can be viewed if **LithiumIon** is selected as the **Batt Type**. This menu allows you to adjust charging and equalization voltage for batteries with specifications that fall outside the default settings for the battery types the Conext SW offers.

Table 4-14 Custom Battery Settings Menu Description

Item	Description
Control	Identifies the kind of battery management system.

**Table 4-14** Custom Battery Settings Menu Description

Item	Description
<b>Bulk Voltage</b>	Sets the bulk voltage for a LithiumIon battery type.
<b>Max Bulk Current</b>	Sets the maximum bulk current for a LithiumIon battery type.
<b>Absorb Voltage</b>	Sets the absorption voltage for a LithiumIon battery type.
<b>Max Absorb Current</b>	Sets the maximum absorption current for a LithiumIon battery type.
<b>Float Voltage</b>	Sets the float voltage for a LithiumIon battery type.
<b>Max Float Current</b>	Sets the maximum float current for a LithiumIon battery type.
<b>DisChgImax</b>	Sets the maximum current discharge in percentage.
<b>DisChgImax Timer</b>	Sets the maximum current discharge timer.

**NOTE:** If a warning is received indicating that a setting is not accepted by the SCP, gradually increase the value of the setting until the SCP accepts it. This type of warning means that an internal minimum threshold value is being crossed and therefore the setting cannot be saved.

## AC Settings

The **AC Settings** menu configures the voltage and frequency limits for AC In. These are the limits at which the Conext SW considers input voltage qualified—that is, suitable for charging batteries or powering loads. If the input voltage is not qualified according to these settings, the Conext SW transfers from using AC input to inverting.

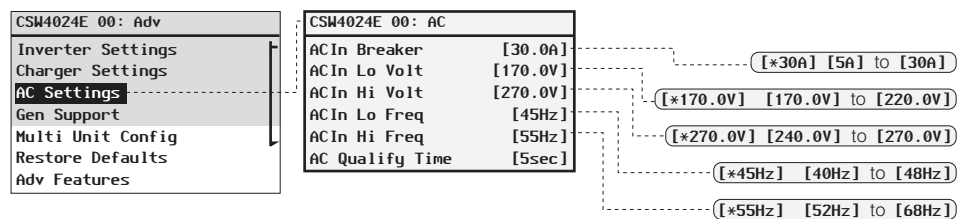

Follow procedures on “To select and change a configurable setting:” on page 4-6 to change the settings.

**Figure 4-8** AC Settings Menu Screen



**Table 4-15** Setting Defaults and Ranges

Model	All Models		
Item	Default	Min	Max
ACIn Breaker	30A	5A	30A
ACIn Lo Volt	170V	170V	220V
ACIn Hi Volt	270V	240V	270V
ACIn Lo Freq	45Hz	40Hz	48Hz
ACIn Hi Freq	55Hz	52Hz	68Hz

**Table 4-16** AC Settings menu

Item	Description
ACIn Breaker	Sets the AC Input breaker size, based on the size of the installed AC breaker. The breaker size must not exceed the capacity of the AC source such as a generator. The Conext SW limits the maximum input current to this setting by derating its charging current. If the connected loads exceed the breaker setting, the AC breaker trips. The breaker may not trip if Load Shave is enabled and Load Shave Amps is configured not to exceed the generator's rated output current.
ACIn Lo Volt	Sets the minimum acceptable input voltage level from the AC source (generator or grid).
ACIn Hi Volt	Sets the maximum acceptable input voltage level from the AC source (generator or grid).
ACIn Lo Freq	Sets the minimum acceptable input frequency from the AC source (generator or grid).
ACIn Hi Freq	Sets the maximum acceptable input frequency from the AC source (generator or grid).

### AC Support Settings

AC Support settings contain configuration options for grid-interactive operation including AC support mode, load shaving (also applicable to generator only AC source), and enhanced AC support for DC coupled systems.

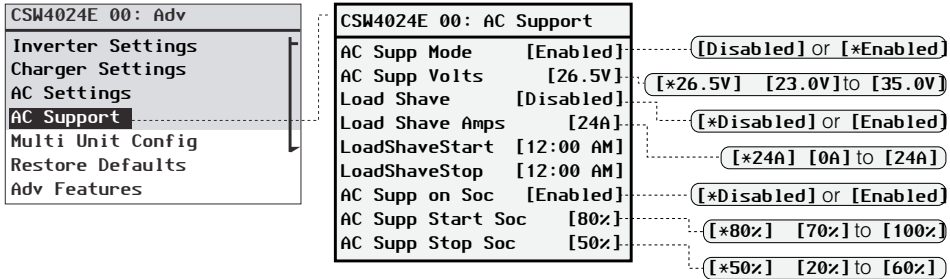

Follow procedures on the Conext SW Owner's Guide to change the settings.

**Figure 4-9** AC Support Menu Screen

**Table 4-17 AC Support Menu Description and Values<sup>a</sup>**

<b>Setting</b>	<b>Description</b>	<b>Default</b>	<b>Range</b>
<b>AC Supp Mode</b>	Turns AC Support Mode feature on and off.	<b>Enabled</b>	<b>Disabled, Enabled</b>
<b>AC Supp Volts</b> For 24-volt models	Battery voltage threshold in order to engage regular AC Support Mode.	<b>26.5V</b> For 24-volt models	<b>23.0V to 35.0V</b>  cannot be set below <b>Low Batt Cut Out + 2 volts</b>
<b>AC Supp Volts</b> For 48-volt model	Battery voltage threshold in order to engage regular AC Support Mode.	<b>53.0V</b> For 48-volt model	<b>46.0V to 70.0V</b>  cannot be set below <b>Low Batt Cut Out + 2 volts</b>
<b>Load Shave</b>	Enables or disables the load shaving feature. When in this mode, the Conext SW operates until the batteries discharge to the <b>Low Batt Cut Out</b> threshold, after which the unit starts charging the batteries. The charger is automatically blocked during the load shaving time window.	<b>Disabled</b>	<b>Disabled, Enabled</b>
<b>Load Shave Amps</b>	Sets the maximum amount of current that can be drawn from the AC source input by the loads and battery charger combined. This setting determines the amperage level at which the inverter starts drawing power from the batteries to add to the power to meet load demands. Typically, this value is set to the peak usage surcharge threshold imposed by the utility, if applicable.	<b>24A</b>	<b>0A to 24A</b>
<b>LoadShave Start</b>	Sets the time for when load shaving is engaged.	<b>12:00 AM</b>	Setting the <b>Load Shave Start</b> and <b>Load Shave Stop</b> to the same time disables scheduling.
<b>LoadShave Stop</b>	Sets the time for when load shaving is disengaged.	<b>12:00 AM</b>	
<b>AC Supp on Soc</b>	Enables or disables the SOC monitoring for AC Support Mode.  This setting must be enabled for <b>AC Supp Start Soc</b> and <b>AC Supp Stop Soc</b> to take effect.	<b>Enabled</b>	<b>Disabled, Enabled</b>
<b>AC Supp Start Soc</b>	Sets the high percentage value of the SOC of the battery for AC Support Mode to engage.  Applicable only when <b>AC Supp on Soc</b> is enabled.	<b>80%</b>	<b>70% to 100%</b>

**Table 4-17** AC Support Menu Description and Values<sup>a</sup>

Setting	Description	Default	Range
<b>AC Supp Stop Soc</b>	Sets the low percentage value of the SOC of the battery for AC Support Mode to disengage.  Applicable only when <b>AC Supp on Soc</b> is enabled.	<b>50%</b>	<b>20% to 60%</b>

a.Applies to all Conext SW models.

**AC Support Mode Setting**

When **AC Support Mode** is enabled, the Conext SW does not ordinarily draw a large amount of current from the grid. If the Conext SW is drawing more current than expected, notice that it cannot distinguish between real power and reactive power. Large current draw will only affect reactive power and not real power, and utility companies generally only charge by real power consumed.

When **AC Support Mode** is enabled, the Conext SW primarily supplies local loads by converting capacity from its battery bank and then only utilizing grid power when the loads demand more capacity. In addition to **AC Support Mode**, the Conext SW also has the enhanced AC support feature. See “Enhanced AC Support Setting” on page 4–28.

When **AC Support Mode** is enabled during multiple unit operation, only one of the units will charge when battery voltage falls below the **ReCharge Volts** setting.

**To use the AC Support Mode feature:**

1. Enable AC support mode. AC support mode is enabled by default. Check only to see if it is enabled. If not, enable it.

Go to Advanced Settings -> AC Support -> AC Supp Mode

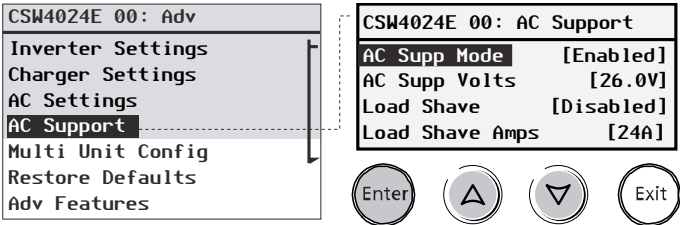

2. Set the battery voltage threshold for AC support mode to engage.  
**NOTE:** Applicable only when there are no Xanbus devices attached as described in “Regular AC Support without Xanbus devices” on page 1–10.

**From AC Support -> AC Supp Volts**

Press Enter, then select a value using the up and down arrow buttons. Press Enter.

<b>CSW4024E 00: AC Support</b>	
AC Supp Mode	[Enabled]
<b>AC Supp Volts</b>	[26.0V]
Load Shave	[Disabled]
Load Shave Amps	[24A]



3. Enable state-of-charge (SOC) monitoring if you have a Conext Battery Monitor installed. AC support on SOC is disabled by default.

**From AC Support -> AC Support on SOC**

Press Enter, then select Enabled using the up and down arrow buttons. Press Enter.

<b>CSW4024E 00: AC Support</b>	
LoadShaveStart	[12:00 AM]
LoadShaveStop	[12:00 AM]
<b>AC Supp on Soc</b>	[Enabled]
AC Supp Start Soc	[80%]



4. Set the battery SOC thresholds for when AC support mode is engaged.

**From AC Support -> AC Supp Start Soc**

Press Enter, then select a value using the up and down arrow buttons. Press Enter.

<b>CSW4024E 00: AC Support</b>	
LoadShaveStop	[12:00 AM]
AC Supp on Soc	[Enabled]
<b>AC Supp Start Soc</b>	[80%]
AC Supp Stop Soc	[20%]

**From AC Support -> AC Supp Stop Soc**

Press Enter, then select a value using the up and down arrow buttons. Press Enter.



## Load Shaving Setting

For Load shaving to be effective, all loads must be connected to the inverter. For large loads, stacked Conext SW inverters may be required. To help the batteries supplement the power requirements of the connected load, an additional source of power (like solar, wind, or hydroelectric) is recommended but not required.

To demonstrate a scenario where load shaving takes effect on the Conext SW, the following settings are programmed into the SCP.

**Scenario**

**Settings:**    **Load Shave=Enabled**  
                   **LoadShaveAmps=10A**  
                   **LoadShaveStart=6:00AM**  
                   **LoadShaveStop=9:00PM**  
                   **PLSDelay=Enabled**

**To use the Load Shaving feature:**

- 1. Enable load shaving.

**Go to Advanced Settings -> AC Support -> Load Shave**

Press Enter, then select **Enabled** using the up and down arrow buttons. Press Enter.

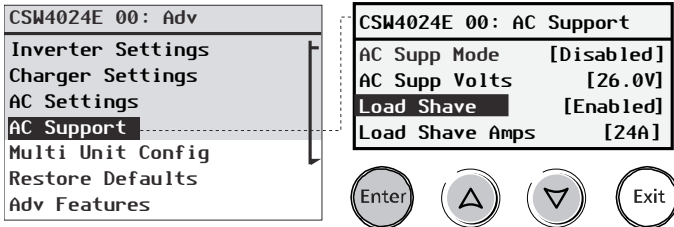

- 2. Set the load shaving amps.

**From AC Support -> Load Shave Amps**

Press Enter, then select a value of **10** using the up and down arrow buttons. Press Enter.

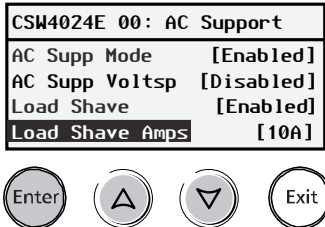

- 3. Set the load shaving start and stop times.

**From AC Support -> LoadShaveStart**

Press Enter, then a time of **6:00 AM** using the up and down arrow buttons. Press Enter.

**From AC Support -> LoadShaveStop**

Press Enter, then a time of **9:00 PM** using the up and down arrow buttons. Press Enter.



- 4. Enable the grid-interactive delay feature.

**Go back to Advanced Settings -> Adv Features -> PLSDelay**

Press Enter, then select **Enabled** using the up and down arrow buttons. Press Enter.

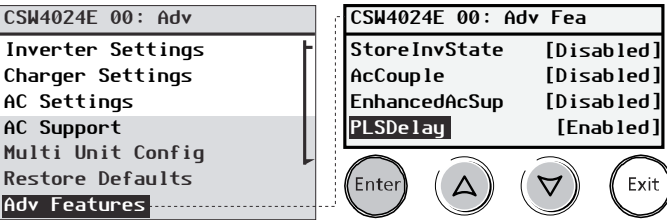

In this scenario, load shaving is only entered and exited as programmed within the time window (from 6 AM to 9 PM).

Additionally, with these scenario settings, the Conext SW would enter load shaving within the configured time and also only if the battery has been charged from an MPPT charge controller in Float (including Absorption) for 2 hours.

**NOTE:** In the absence of an MPPT charge controller, charger block stop and start settings must be set at the same times as the load shaving stop and start settings. Otherwise, charging may start even during load shaving.

## Enhanced AC Support Setting

### Self-consumption

The goal of the enhanced AC support (**EnhancedAcSup**) feature is to make sure that the power system self-consumes the power it harvests from a PV array. It does this by keeping the battery bank charged up and ready to supply power to the loads.

When **EnhancedAcSup** is enabled, the Conext SW supports local loads by converting excess capacity from external DC sources connected to its battery bank. An example of an external DC source is the Conext MPPT solar charge controller like the MPPT 80 600.

### To use the Enhanced AC Support feature:

1. Enable AC support mode. AC support mode is enabled by default. Check only to see if it is enabled. If not, enable it.

Go to Advanced Settings -> AC Support -> AC Supp Mode

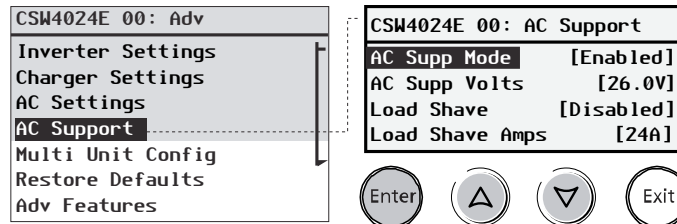

2. Enable enhanced AC support.

Go back to Advanced Settings -> Adv Features -> EnhancedAcSup

Press Enter, then select Enabled using the up and down arrow buttons. Press Enter.

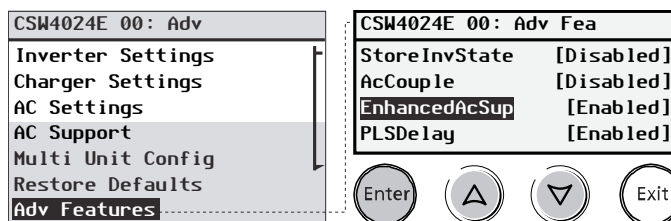

## Multi Unit Config Menu

The **Multi Unit Config** menu configures the Conext SW to operate as a part of a multiple unit installation<sup>1</sup>.

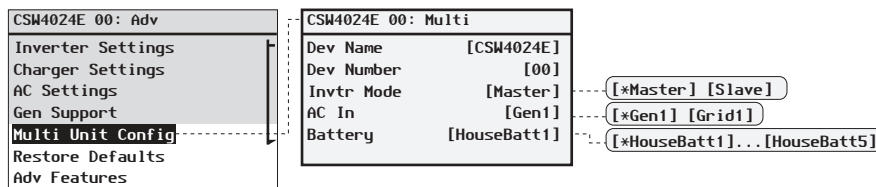

Follow procedures on “To select and change a configurable setting:” on page 4–6 to change the settings.

**Figure 4-10** Multi Unit Config Menu Screen

**IMPORTANT:** Accessing this menu automatically places the Conext SW in standby mode. When entering the **Multi Unit Config** menu, the unit identifies itself by flashing all front panel LEDs. After exiting the **Multi Unit Config** menu, the Conext SW returns to operating mode and the front panel LEDs stop flashing.

**Table 4-18** Multi Unit Menu Description and Values<sup>a</sup>

Item	Description	Default	Range
<b>Dev Name</b>	Allows the customizing of the default name for the inverter/charger. This setting is optional and does not affect operation. See “Setting the Device Name” on page 4–30.	<b>CSW4024E</b> will vary from model to model.	Can be changed by the user.
<b>Dev Number</b>	Allows setting of a unique unit number in a multiple-unit system. See “Setting the Device Number” on page 4–31.	<b>00</b> usually for a single unit or for two units, this will designate the master.	<b>00–31</b>
<b>Invtr Mode</b>	For this to operate, one Conext SW must be configured to <b>Master</b> and the other as <b>Slave</b> , otherwise a system-wide fault is asserted.	<b>Master</b>	<b>Master, Slave</b>

1. In Conext SW Inverter/Chargers, multiple unit configuration (installation) is limited to two units - one master unit and one slave unit.

**Table 4-18** Multi Unit Menu Description and Values<sup>a</sup>

Item	Description	Default	Range
<b>AC In</b>	For identifying the type of AC source when two power sources are available and an AGS is also present.	<b>Gen1</b>	<b>Gen1, Grid1</b>
<b>Battery</b>	For identifying batteries only.	<b>HouseBatt1</b>	<b>HouseBatt1... HouseBatt5</b>

a. Applies to all Conext SW models.

When installing a multiple unit system, every setting on the **Multi Unit Config** menu (except for **Dev Name**) must be configured for each Conext SW in the system. The settings should be configured in the following order: **Dev Number** then **Invtr Mode**.

**AC In setting**

The Conext SW accepts only a single AC source - either from the grid or from a generator. In a power system where the Conext SW is solely connected to the grid and an AGS is neither present nor required, the **AC In** setting can be either **Gen1** or **Grid1**. Therefore, the default value of **Gen1** need not be changed.

In a situation where the AC source is a generator and the AGS is being used to start the generator to produce AC power, the **AC In** setting must be set to **Gen1**. Therefore, the default value of **Gen1** must remain unchanged.

In a power system where the two AC sources are available but only one AC source can be used, an external transfer switch becomes necessary. When an external transfer switch is used and an AGS (with a B+ signal connection) is also present, change the **AC In** setting to **Grid1**.

**Setting the Device Name**

The **Dev Name** setting allows you to customize the name of the Conext SW as it is displayed on other screens and menus.

The available characters are:

- A to Z
- a to z
- 0 to 9
- space

---

**NOTE:** Increasing the number of characters in a device name may cause other text on the same line to run off the edge of the screen. Device names should be limited to 10 characters or less.

---



**To customize the Conext SW name:**

1. On the device setup menu, select **Advanced Settings**.  
If **Basic Settings** appears instead of **Advanced Settings** on the Setup menu, display **Advanced Settings** by pressing Enter + up arrow + down arrow simultaneously.  
On the **Advanced Settings** menu, select **Multi Unit Config**, and then press Enter.
2. Select **Dev Name**, and then press Enter.  
The last letter of the Conext SW name is highlighted.
3. Begin customizing the device name.
  - To change the character, press the up or down arrow button. Holding down the button causes the characters to scroll more quickly.
  - To delete the character, press Exit.
  - To add characters, press Enter.
4. When the correct character is shown, press Enter to select it.
5. After pressing Enter to select the last character of your customized device name, press Enter again to return to the menu.

## Setting the Device Number

Setting the device number gives a Xanbus-enabled device a unique identity when several devices of the same type are installed in the networked power system. When each identical device has a unique number, the SCP can correctly identify and display status information for each device. A device number consists of two digits ranging from 00 (default) to 31.

If only one of each device is installed in the networked power system, you do not need to set the device number. However, setting the device number to a value other than 00 is recommended in case you need to use the **Restore Defaults** command. After performing the command, checking that the device number has returned to 00 indicates that the command was successfully completed.

**To set the Conext SW device number:**

1. On the Conext SW **Setup** menu, select **Advanced Settings**.  
If **Basic Settings** appears instead of **Advanced Settings** on the Setup menu, display **Advanced Settings** by pressing Enter + up arrow + down arrow simultaneously.  
On the **Advanced Settings** menu, select **Multi Unit Config**, and then press Enter.
2. On the **Multi Unit Config** menu, select **Dev Number**. See Figure 4-11.
3. Press Enter to highlight the instance number.
4. Use the up and down arrow buttons to adjust the two-digit identifier number.
5. Press Enter.

CSW4024E 01: Multi	
Dev Name	[CSW4024E]
Dev Number	[01]
Invtr Mode	[Slave]
Battery	[HouseBatt1]

Follow procedures on “To select and change a configurable setting:” on page 4–6 to change the settings.

**Figure 4-11** Setting a Device Number

## Restoring Factory Default Settings

The **Restore Defaults** command returns the Conext SW to factory default settings. After using the **Restore Defaults** command, the Conext SW is no longer configured for the power system.

<b>NOTICE</b>
<p><b>EQUIPMENT DAMAGE</b></p> <p>Do not use the <b>Restore Defaults</b> command while the Conext SW is operating. De-energize the power system and disconnect the Conext SW AC input before using the <b>Restore Defaults</b> command. Reconfigure the Conext SW before reconnecting the AC input and re-energizing the power system.</p> <p><b>Failure to follow these instructions can damage the inverter/charger.</b></p>

### To restore Conext SW default settings:

1. On the **Advanced Setup** menu, select **Restore Defaults**.  
Warning W252 appears, asking to confirm the **Restore Defaults** command.
2. To cancel the command, press Exit. To continue with the **Restore Defaults** command, press Enter.

---

**IMPORTANT:** If a warning is already active in the system, selecting Restore Defaults brings up the Warning List, with warning W252 at the top. Press Enter to view W252 and continue with the Restore Defaults process.

---

**IMPORTANT:** Restoring to default also means that the AC output frequency will change back to 50 Hz. See “Advanced Features Menu” on page 4–33 for information on changing the AC output frequency to 60 Hz.

---

## Advanced Features Menu

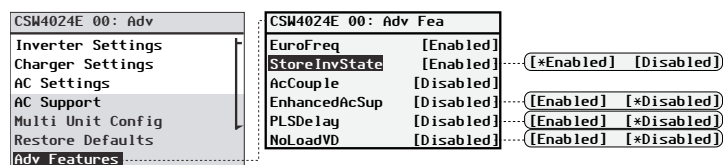

See “To select and change a configurable setting:” on page 4–6 to change the settings.

**Figure 4-12** Adv Features Menu Screen

**Table 4-19** Adv Features Description and Values<sup>a</sup>

Item	Description	Default	Range
<b>EuroFreq</b>	When enabled, sets the AC output frequency to a constant 50Hz.	<b>Enabled</b>	<b>Enabled, Disabled</b>
<b>StoreInv State</b>	See “Storing the State of the Inverter Mode” on page 1–12.	<b>Enabled</b>	<b>Enabled, Disabled</b>
<b>AcCouple</b>	For information on this feature refer to the <i>AC Coupling Solutions Guide</i> .	<b>Disabled</b>	<b>Enabled, Disabled</b>
<b>Enhanced AC Sup</b>	See “Enhanced AC Support” on page 1–8.	<b>Disabled</b>	<b>Disabled, Enabled</b>
<b>PLSDelay</b>	Delays load shaving and AC support features until the MPPT has charged the battery in float mode for 2 hours. See “Grid-Interactive Delay Feature” on page 1–10.	<b>Disabled</b>	<b>Disabled, Enabled</b>
<b>NoLoadVD</b>	See “NoLoadVD” on page 1–12.	<b>Disabled</b>	<b>Enabled, Disabled</b>

a. Applies to all Conext SW models.

## EuroFreq Feature

The default inverter AC output frequency is 50 Hz.

### To change the inverter AC output frequency to 60 Hz:

1. Put the system in Standby mode. See “To change an operational setting:” on page 3–17.
2. Change the EuroFreq to **Enabled**. See “To select and change a configurable setting:” on page 4–6.

***NOTICE***

**EQUIPMENT DAMAGE**

Do not change the frequency to 60 Hz unless the equipment and appliances connected to the inverter's output can operate in this frequency setting.

**Failure to follow these instructions can result in equipment damage.**

3. Restore the system to Operating mode. See "To change an operational setting:" on page 3-17.

---

**IMPORTANT:** Restoring to default (see "Restoring Factory Default Settings" on page 4-32) means that the AC output frequency will change back to 50 Hz.

---

# Configuration Sheet

SETTING		DESCRIPTION	DEFAULT 24-VOLT	DEFAULT 48-VOLT	YOUR SETTING
Inverter Settings	<b>Low Batt Cut Out</b>	Select battery voltage below which batteries will be cut out	21.0V	42.0V	
	<b>LBCO Delay</b>	Select the time delay before low battery cut out is engaged	10sec	10sec	
	<b>Hi Batt Cut Out</b>	Select the voltage above which batteries will be cut out	29.0V	58.0V	
	<b>Search Watts</b>	Select Watts at which level Search Mode triggers on	50W	50W	
	<b>Search Delay</b>	Select delay time before Search Mode triggers on	2sec	2sec	
	<b>Inv Block Start</b>	Sets the time to halt inverting	12:00AM	12:00AM	
	<b>Inv Block Stop</b>	Sets the time to resume inverting	12:00AM	12:00AM	
Charger Settings	<b>Batt Type</b>	Select your battery type (FLOODED, GEL, AGM, etc...)	Flooded	Flooded	
	<b>Custom Settings</b>	Makes BATTERY CUSTOM SETTINGS screen visible	--	--	
	<b>EqLz Support</b>	Enable battery EQUALIZE function	Enabled	Enabled	
	<b>EqLz Voltage</b>	Select maximum EQUALIZE voltage	32.0V	62.0V	
	<b>Bulk Voltage</b>	Select maximum BULK charge voltage	28.8V	57.6V	
	<b>Absorb Voltage</b>	Select maximum ABSORPTION charge voltage	28.8V	57.6V	
	<b>Float Voltage</b>	Select maximum FLOAT charge voltage	27.0V	54.0V	
	<b>Batt Temp Comp</b>	Select BATTERY TEMPERATURE COMP coefficient	-54mV/C	-108mV/C	
	<b>Batt Capacity</b>	Select battery bank capacity	250Ah	250Ah	
	<b>Max Chg Rate</b>	Select maximum charge rate	100%	100%	
	<b>Charge Cycle</b>	Select 2 or 3 stage charge cycle	3Stage	3Stage	
	<b>Default Batt Temp</b>	Select system default battery temp setting	Warm	Warm	
	<b>ReCharge Volts</b>	Select voltage at which charger will initiate a charge cycle	25.0V	50.0V	
	<b>Absorb Time</b>	Sets the maximum Absorption time	180min	180min	
	<b>Auto Chg Enable</b>	Select automatic charging, overrides Charger setup	Disabled	Disabled	
<b>Chg Block Start</b>	Sets the time to halt charging	12:00AM	12:00AM		
<b>Chg Block Stop</b>	Sets the time to resume charging	12:00AM	12:00AM		
AC Settings	<b>AC Breaker</b>	Select AC Input current limit	30A	30A	
	<b>AC Lo Volt</b>	Select lowest acceptable AC voltage	202V	202V	
	<b>AC Hi Volt</b>	Select highest acceptable AC voltage	260V	260V	
	<b>AC Lo Freq</b>	Select lowest acceptable AC frequency	45Hz	45Hz	
	<b>AC Hi Freq</b>	Select highest acceptable AC frequency	55Hz	55Hz	
AC Support	<b>AC Supp Mode</b>	Sets the AC Support feature	Enabled	Enabled	
	<b>AC Supp Volts</b>	Sets the AC support voltage	26.5V	53.0V	
	<b>Load Shave</b>	Sets the load shaving feature	Disabled	Disabled	
	<b>Load Shave Amps</b>	Sets the current for load shaving	24A	24A	
	<b>Load Shave Start</b>	Sets the start time for load shaving	12:00 AM	12:00 AM	
	<b>Load Shave Stop</b>	Sets the stop time for load shaving	12:00 AM	12:00 AM	
	<b>AC Supp on Soc</b>	Sets the AC Support feature based on SOC	Enabled	Enabled	
	<b>AC Supp Start Soc</b>	Sets the start time for SOC AC support	80%	80%	
<b>AC Supp Stop Soc</b>	Sets the stop time for SOC AC support	50%	50%		

Configuration via SCP

SETTING		DESCRIPTION	DEFAULT 24-VOLT	DEFAULT 48-VOLT	YOUR SETTING
Multi Unit Config	<b>Dev Name</b>	Select unique device Name for each unit	CSW4024E CSW2524E	CSW4048E	
	<b>Dev Number</b>	Select unique device number for each unit	00	00	
	<b>Invtr Mode</b>	Select Master or Slave designation for each unit	Master	Master	
	<b>AC In</b>	Select AC source type	Gen1	Gen1	
	<b>Battery</b>	Identify batteries	HouseBatt1	HouseBatt1	
Restore Defaults	<b>Restore Defaults</b>	Restores all system default settings	--	--	
Advanced Features	<b>EuroFreq</b>	Sets AC output frequency to 50 Hertz	Enabled	Enabled	
	<b>StoreInv State</b>	Sets inverter mode state feature.	Enabled	Enabled	
	<b>AcCouple</b>	Sets AC Coupling feature. See "AC Coupling" on page 1-11.	Disabled	Disabled	
	<b>Enhanced ACSup</b>	Sets enhanced AC Support feature. See "Enhanced AC Support" on page 1-8.	Disabled	Disabled	
	<b>PLSDelay</b>	Sets load shaving delay for 2 hours. See "Grid-Interactive Delay Feature" on page 1-10.	Disabled	Disabled	
	<b>NoLoadVD</b>	Sets no load voltage derating feature. See "NoLoadVD" on page 1-12.	Enabled	Enabled	

# 5

## Troubleshooting

The following topics will be covered in this chapter.

- General Troubleshooting Guidelines
- Inverter Applications
- View Device Info Logs
- Troubleshooting the Conext SW via the SCP

## General Troubleshooting Guidelines

This section will help you narrow down the source of any problem you may encounter. Please read the following troubleshooting steps:

1. Check for a warning or fault detection message on the SCP or a fault code on the inverter information panel. If a message is displayed, record it immediately.
2. As soon as possible, record the conditions at the time the problem occurred. These details should include the following as well as any other information asked for on the page. These details are:
  - Firmware revision of the Conext SW
  - Type of loads the Conext SW was running or attempting to run
  - Battery condition at the time of fault detection (battery voltage or temperature, for example), if known
  - Recent sequence of events (for example, charging had just finished, AC generator had stopped but the inverter did not come on)
  - Any known unusual AC input factors such as low voltage or unstable generator output
  - Extreme conditions which may have existed at the time (temperature or moisture, for example)
3. Attempt the solution indicated in these guidelines.
4. If your inverter front panel or SCP is not displaying a Fault detection light, check the following list to make sure that the present state of the installation allows proper operation of the unit. Read these guidelines carefully.
  - Is the Conext SW located in a clean, dry, adequately ventilated area?
  - Have the AC input breakers opened? If so, your pass-through load may have exceeded the rating of one or more of the input breakers.
  - Are the battery cables adequately sized and short enough? See the Installation Guide for more information.
  - Is the battery in good condition and are all DC connections tight?
  - Are the AC input and output connections and wiring in good condition?
  - Are the configuration settings correct for your particular installation?
  - Are the display panel and the communications cable properly connected and undamaged?
  - Is the battery temperature sensor and its cable properly connected and undamaged?
5. Contact Customer Service for further assistance. Please be prepared to describe details of your system installation and provide the model and serial number of the unit. See the front and/or back of the manual for contact information.



---

# Inverter Applications

The Conext SW performs differently depending on the AC loads connected to it. If you are having problems with any of your loads, read this section.

## Resistive Loads

Resistive loads are the easiest and most efficient to drive. Voltage and current are in phase, which means they are in step with one another. Resistive loads generate heat in order to accomplish their tasks. Toasters, coffee pots, and incandescent lights are typical resistive loads. It is usually impractical to run larger resistive loads—such as electric stoves and water heaters—from an inverter due to their high current requirements. Even though the inverter may be able to accommodate the load, the size of battery bank will limit inverter run time.

## Motor Loads

Induction motors (AC motors without brushes) require up to six times their running current on startup. The most demanding are those that start under load (for example, compressors and pumps). Of the capacitor start motors (typical in drill presses and band saws, for example), the largest you can expect to run is 1 horsepower. Universal motors are generally easier to start. Check that the Locked Rotor Amps (LRA) rating of the motor load does not exceed the maximum surge current rating of the inverter. Since motor characteristics vary, only testing will determine whether a specific load can be started and how long it can be run.

If a motor does not start within a few seconds or loses power after running for a time, it should be turned off. When the inverter attempts to start a load that is greater than it can handle, the inverter may shut down from an AC overload fault.

## Problem Loads

**Very Small Loads** If the power consumed by a device is less than the threshold of the search mode circuitry, and search mode is enabled, the inverter will not run. Most likely the solution will be to disable **Search Mode** or lower the sense threshold.

**Fluorescent Lights (CFL) and Power Supplies** Some devices cannot be detected when scanned by search mode circuitry. Small fluorescent lights are the most common example. Some computers and sophisticated electronics have power supplies that do not present a load until line voltage is available. When this occurs, each unit waits for the other to begin. To drive these loads, either a small companion load like a light bulb rated for more than the **Search Watts** setting must be used to bring the inverter out of search mode, or the inverter may be programmed to remain on by disabling **Search Mode**. (See “Using Search Mode” on page 4–11.)

**Clocks** You may notice that your clocks are not accurate. Some of the clocks on your appliances may reset when the Conext SW is in search mode.

**Searching** When the inverter is in search mode, it may not start some loads even though the rated wattage on the load is more than the **Search Watts** setting. Disable **Search** or apply an additional load (companion load) to make the inverter exit search mode.

## View Device Info Logs

When troubleshooting, it sometimes becomes necessary to look at information logs the Conext SW keeps inside its onboard memory. Each log entry is generated automatically when a “condition” occurs and recorded accordingly in one of the information logs.

The information logs are organized according to:

- Fault detections
- Warnings
- Events

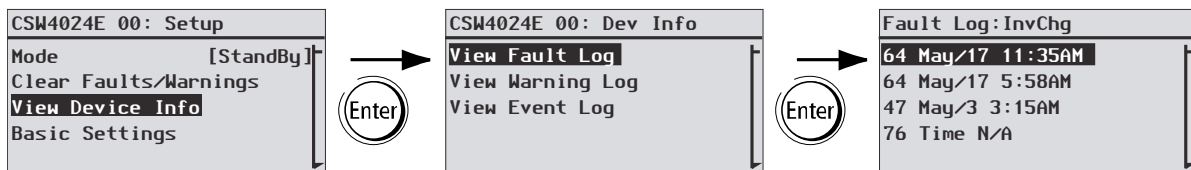

**Figure 5-1** View Device Info Log

### To view device info logs:

1. From the device **Setup** menu screen, use the up or down arrow buttons to highlight **View Device Info**.
2. Press Enter. The **Dev Info** screen appears.
3. Use the up or down arrow buttons to select which information log you want to view then press Enter to confirm a selection. The log screen appears.
4. Use the up or down arrow buttons to scroll the list then press Enter to view the particular log entry.
5. Press the Exit button to return to previous screens.

## Troubleshooting the Conext SW via the SCP

The Conext SW is designed with a number of protection features to provide efficient operation. If, however, you have any problems operating your inverter/charger read this troubleshooting chapter.

If you cannot resolve the problem, record the necessary information. This information will help Customer Service to assist you better when you contact them.

### DANGER

#### ELECTRICAL SHOCK HAZARD

Do not disassemble the inverter/charger. The Conext SW contains no user-serviceable parts.

**Failure to follow these instructions will result in death or serious injury.**

When a fault detection or warning message appears, you can acknowledge the message to clear the screen. To acknowledge a fault detection or warning message, press the **Enter** button on the SCP. This action does not clear the fault detection or warning condition, so you should consult Table 5-3 for suggested actions after you have acknowledged the message. Refer to the *System Control Panel Owner's Guide* for more information on faults and warnings.

## Fault Detection Types

There are three types of fault detection messages: automatic, manual, and escalating automatic. Table 5-1 describes how they differ in their behavior and how you can respond to them when they appear on the SCP.

**Table 5-1** Fault Detection Types and Behaviors

Fault Detection type	Behavior
Automatic	Clears automatically if the fault condition that generated the message goes away. You can also acknowledge automatic fault detections without waiting for them to clear automatically.
Manual	Require you to clear them by: <ul style="list-style-type: none"> <li>pushing the Clear Fault button on the Conext SW or on the device that generated the fault detection (if the fault condition still exists, the fault detection message reappears), and</li> <li>correcting the condition that caused the fault.</li> </ul>

**Table 5-1** Fault Detection Types and Behaviors

Fault Detection type	Behavior
Escalating automatic	<p data-bbox="764 306 1383 373">Clears automatically if the fault condition goes away, just like an automatic fault detection.</p> <p data-bbox="764 394 1383 680">However, if an escalating automatic fault detection occurs several times within a defined time period, the escalating automatic fault detection becomes a manual fault detection, requiring user intervention. For example, if three fault detections occur in one minute, it will no longer clear itself but becomes a manual fault detection. Then you must identify the problem, correct the fault condition, and clear the fault detection or reset the device.</p>

**To view a list of the detected faults:**

1. On the **Select Device** menu, highlight **System** and press Enter.
2. On the **System Settings** menu, highlight **View Fault List**.
3. Press Enter.

## Warning Types

There are two types of warnings: automatic and manual. When the Conext SW detects a warning condition, it displays a warning message on the SCP.

Table 5-2 describes how they differ in their behavior and in how you can respond to them when they appear on the SCP.

**Table 5-2** Warning Types and Behavior

Warning type	Behavior
Automatic warning	<p data-bbox="764 1245 1383 1373">Clears automatically if the warning condition that generated the message goes away. You can also acknowledge automatic warnings without waiting for them to clear automatically.</p>
Manual warning	<p data-bbox="764 1383 1383 1570">Requires you to acknowledge it before you can proceed with configuring or operating the Conext SW. Manual warnings are usually in the form of a Yes/No question that you may acknowledge by pressing the <b>Enter</b> button on the SCP for Yes and the <b>Exit</b> button for No.</p> <p data-bbox="764 1591 1383 1661">Refer to the <i>System Control Panel Owner's Guide</i> for more information.</p>

**To view a warning list:**

1. On the **Select Device** menu, highlight **System** and press Enter.
2. On the **System Settings** menu, highlight **View Warning List**.
3. Press Enter.

Table 5-3 provides a detailed description of the fault detection messages and solutions. If you are unable to resolve the problem after referring to this table, contact customer service.

**Table 5-3** Fault Detection Messages

Code	Message	Type	Cause	Solution
F1	<b>AC Output under voltage</b>	Escalating Auto fault detection. Must occur 3 times in 30 seconds before becoming a manual fault detection.	Inverter voltage is under 202 volts.	Remove excessive load.
F2	<b>AC Output over voltage</b>	Escalating Auto fault detection. Must occur 3 times in 30 seconds before becoming a manual fault detection.	Inverter voltage is over 260 volts.	Check if there is an external power source that is running parallel to the inverter's output.
F17	<b>AC Backfeed</b>	Manual	AC backfeed from welded relay.	Service required.
F44	<b>Battery Over Temperature</b>	Automatic	Battery temperature is over 60 °C.  Poor battery compartment ventilation.	Stop charging if necessary.  Check cable connections.  Check battery voltage/current and temperature. If battery is not accepting charge, it may need to be replaced.  Check for excessive ambient temperature and adequate ventilation in the battery compartment.
		Automatic	BTS may be damaged.	If the unit displays a temperature of over 100 °C, the BTS will need to be replaced.

**Table 5-3** Fault Detection Messages

Code	Message	Type	Cause	Solution
F47	<b>DC Under Voltage (Immediate)</b>	Automatic	Immediate battery under voltage fault.	<p>Check battery condition (short or open cells) and ensure correct voltage.</p> <p>Battery state charge or capacity is so low that the DC voltage collapses when inverter load is applied.</p> <p>Inverter load is so large that the DC voltage collapses when inverter load is applied.</p>
F48	<b>DC Under Voltage (Fault)</b>	Automatic	<p>Voltage at the DC input terminals is below the Low Battery Cut Out (LBCO) setting for 10 seconds.</p>	<p>Check for the correct battery voltage at the inverter's DC input terminals.</p> <p>Check for external DC loads on the batteries.</p> <p>Check condition of batteries and recharge if necessary.</p> <p>Reduce the Low Battery Cut Out (LBCO) setting.</p> <p>Battery bank capacity may be inadequate for the loads in the system.</p>
			Battery is discharged.	Charge the battery.
F49	<b>DC Over Voltage</b>	Escalating Auto fault detection. Must occur 3 times in 30 seconds before becoming a manual fault detection.	Voltage at the DC input terminals is above the High Battery Cut Out Setting	Clear the fault and attempt restart. Ensure battery voltage is 21–33 VDC (default settings) at Conext SW terminals. Check all other charging source outputs, battery cables.
F52	<b>EE ERROR</b>	Manual	A problem has been detected with the internal memory.	Clear the fault and check the latest configuration made or any recent configurations. If fault detection reoccurs or occurs frequently, service is required.
F53	<b>EE ERROR</b>			
F54	<b>EE ERROR</b>			
F55	<b>EE ERROR</b>			
F56	<b>EE ERROR</b>			

**Table 5-3** Fault Detection Messages

Code	Message	Type	Cause	Solution
F57	<b>FET1 Over Temperature</b>	Automatic	Ambient temperature may be too high.	Ensure adequate ventilation around the Conext SW.  Allow inverter to cool down and try restarting.
			Operating too large of a load for too long while inverting.	Remove excessive inverter loads.
			Inverter cooling fan may have stopped working.	If the temperature is above 40 °C, the fan should be on. Hold your hand or a piece of paper to the inverter vent to check if the fan is working.  Both fans should be active at the same time.
			Inverter airflow intake may be blocked.	Increase the clearance around the inverter and/or unclog the airflow intake vents.
F58	<b>FET2 Over Temperature</b>	Automatic	Same as F57.	Same as F57.
F63	<b>Power Board Temp unreadable.</b>	Automatic	Temperature sensor is damaged.	Service required.
F64	<b>AC overload</b>	Escalating Auto fault detection. Must occur 3 times in 60 seconds before becoming a manual fault.	Persistent excessive inverter current above rated current.	Avoid loads with long surge current.
F68	<b>Transformer Over Temperature</b>	Automatic	Same as F57.	Same as F57.
F70	<b>Unique Dev# Needed</b>	Automatic	In a Multi Unit configuration—if two or more units have the same device number.	Assign a unique device number for each unit. See “To set the Conext SW device number:” on page 4–31.
F71	<b>Too Many Masters</b>	Automatic	In a Multi Unit configuration—if more than one unit is configured as Master.	There can only be one Master unit. Assign the other units as Slave. See “Multi Unit Config Menu” on page 4–29.

**Table 5-3** Fault Detection Messages

Code	Message	Type	Cause	Solution
F73	<b>Transformer Temp unreadable</b>	Automatic	Temperature sensor is damaged.	Service required.
F74	<b>Other Unit Invert Fault</b>	Automatic	In a Multi Unit configuration—if one of the units detects a fault that needs to be resolved.	Clear the primary fault on the unit that caused this fault to be detected.
F75	<b>Master Inverter Lost</b>	Automatic	In a Multi Unit configuration—if the Slave unit cannot detect the Master unit in the Xanbus network.	Make sure that the two units are connected in the same Xanbus network. Check cable connections and ensure that the plugs are neatly inserted in the ports. Check if the Xanbus network is properly installed with network terminators.
F76	<b>No Masters</b>	Automatic	In a Multi Unit configuration—if all units are configured as Slave.	Assign the other unit as Master. See “Multi Unit Config Menu” on page 4–29.
F79	<b>Battery Sensor Short</b>	Automatic	The BTS has been damaged.	Replace the BTS.
F85	<b>PowerBoard Over Temperature</b>	Automatic	Same as <b>F57</b> .	Same as <b>F57</b> .
F87	<b>Inconsistent Frequencies</b>	Automatic	In a Multi Unit configuration—if all units are not configured to the same AC output frequency.	Configure all units to the same AC output frequency. See “Advanced Features Menu” on page 4–33.
F88	<b>MPPT Ground Fault</b>	Automatic	In a Xanbus network, an MPPT has detected a ground fault <b>F56</b> .	Check the MPPT and clear the ground fault <b>F56</b> .
F89	<b>Battery Discharge Over Current</b>	Escalating	There is an excessive load on the Li-ion battery. This fault applies only to Li-ion batteries.	Change the default threshold of the max battery discharge current limit or reduce the load.



**Table 5-3** Fault Detection Messages

Code	Message	Type	Cause	Solution
F90	<b>External BMS Disconnected</b>	Automatic	Communication has been lost with the Battery Management System of the Li-ion battery.	Check the Xanbus network connections to the Li-ion battery. Contact the battery manufacturer if a connection problem cannot be found.
F93	<b>Wrong Batt Temperature Sensor</b>	Automatic	An unknowns BTS was plugged into the BTS port.	Use only the BTS that was provided with the Conext SW Inverter/Charger. To order, use product number 808-0232-02.

Table 5-4 provides a detailed description of the warning messages and solutions. If you are unable to resolve the problem after referring to this table, contact customer service.

**Table 5-4** Warning Messages

Code	Message	Fault Type	Cause	Solution
W48	<b>DC under voltage (Warning)</b>	Automatic	Voltage at the DC input terminals is below the Low Battery Cut Out (LBCO) setting.	<p>Check for the correct battery voltage at the inverter's DC input terminals.</p> <p>Check for external DC loads on the batteries.</p> <p>Check condition of batteries and recharge if necessary.</p> <p>Reduce the Low Battery Cut Out (LBCO) setting.</p> <p>Battery bank capacity may be inadequate for the loads in the system.</p>



# 6

## Specifications

---

**NOTE:** Specifications are subject to change without prior notice.

---

## Inverter Specifications

**NOTE:** All inverter specifications are at nominal conditions: ambient temperature of 25 °C, 230 VAC, 50 Hz input, unless otherwise specified

<b>AC Output</b>	<b>SW 2524 230</b>	<b>SW 4024 230</b>	<b>SW 4048 230</b>
Output waveform	true sine wave	true sine wave	true sine wave
Output power (AC) - Maximum continuous - 30 minutes - 5-second surge	2500 W 2800 W <sup>a</sup> 5000 W <sup>b</sup>	3400 W 4000 W <sup>c</sup> 7000 W <sup>d</sup>	3800 W <sup>e</sup> 4400 W <sup>e</sup> 7000 W
Maximum continuous allowable (in pass-thru)	30 A	30 A	30 A
Inverter continuous output current	11 A	16 A	16 A
Inverter peak output current	24.3 A	42 A	42 A
AC OUTPUT connection	Single-Phase (L, N, ⊕)	Single-Phase (L, N, ⊕)	Single-Phase (L, N, ⊕)
Peak efficiency	91.5%	92%	94%
Operating voltage range	216–232 VAC	216–232 VAC	219–240 VAC
Nominal voltage	230 VAC	230 VAC	240 VAC
Operating frequency range	selectable 50 or 60 Hz	selectable 50 or 60 Hz	selectable 50 or 60 Hz
Default output frequency	50 Hz	50 Hz	50 Hz
<b>DC Input</b>	<b>SW 2524 230</b>	<b>SW 4024 230</b>	<b>SW 4048 230</b>
Voltage range	20–34 VDC	20–34 VDC	40–64 VDC
Maximum short-circuit current	10,000A	10,000A	10,000A
Maximum continuous power voltage range	22–27 VDC	22–27 VDC	46–48 VDC
Maximum allowable current	250 A	250 A	250 A
No-load power draw (Inverter On)	38 W	40 W	27 W
Low battery voltage shutdown cut-off (other values selectable)	21.0 V (default)	21.0 V (default)	42.0 V (default)
High battery voltage shutdown cut-off (other values selectable)	33.0 V (default)	33.0 V (default)	62.0 V (default)

a. Duty cycle 2800 W for 30 minutes, 0 W for 45 minutes.

b. Duty cycle 5000 W for 5 seconds, 2500 W for 300 seconds.

c. Duty cycle 4000 W for 30 minutes, 0 W for 30 minutes.

d. Duty cycle 7000 W for 5 seconds, 3400 W for 300 seconds.

e. When NoLoadVD is enabled.

## Charger Specifications

**NOTE:** All charging specifications are at nominal conditions: ambient temperature of 25 °C, 230 VAC, 50 Hz input, unless otherwise specified.

DC Output	SW 2524 230	SW 4024 230	SW 4048 230
Maximum output current	65 A	90 A <sup>a</sup>	45 A
Nominal output voltage	24 VDC	24 VDC	48 VDC
Charging output voltage operation range <sup>b</sup>	12.0–32.0 VDC	12.0–32.0 VDC	24.0–64.0 VDC
Equalization cycle	Manual by SCP	Manual by SCP	Manual by SCP
Optimal charging efficiency	90%	90%	92%
Dead battery charge voltage	> 12.0 VDC	> 12.0 VDC	> 24.0 VDC
Charging methods (two settings)	Three-stage charge (Bulk, Absorption, Float) [default] Two-stage charge (Bulk, Absorption)		
Without a battery temperature sensor (three settings)	Cool 10 °C Warm 25 °C [default] Hot 40 °C		
With a battery temperature sensor (provided)	<p>The temperature compensation coefficients on a <b>24-volt battery</b> are as follows:            Flooded: 54 mV × (25 °C – BTS °C)            Gel: 54 mV × (25 °C – BTS °C)            AGM: 42 mV × (25 °C – BTS °C)</p> <p>The temperature compensation coefficients on a <b>48-volt battery</b> are as follows:            Flooded: 108 mV × (25 °C – BTS °C)            Gel: 108 mV × (25 °C – BTS °C)            AGM: 84 mV × (25 °C – BTS °C)</p>		

a.Charging current derates up to 5% between 35 to 60 °C.

b.Recharging does not occur when battery voltage is below 12 V.

AC Input	SW 2524 230	SW 4024 230	SW 4048 230
Power factor at full charge rate	> 0.98	> 0.98	> 0.98
Current <sup>a</sup>	10.6 A	14 A	15 A
Maximum continuous allowable	30 A	30 A	30 A

## Specifications

AC Input	SW 2524 230	SW 4024 230	SW 4048 230
Voltage	230 VAC	230 VAC	230 VAC
Voltage range <sup>b</sup>	170–270 VAC	170–270 VAC	170–270 VAC
Frequency range	40 – 70Hz	40 – 70 Hz	40 – 70 Hz
Maximum short-circuit current	10,000 A	10,000 A	10,000 A
AC INPUT Connection	Single-Phase (L, N, ⊕)	Single-Phase (L, N, ⊕)	Single-Phase (L, N, ⊕)
Supplemental protector (resettable)	30 A	30 A	30 A

a. See Table 6-1, "Inverter Output Power versus Temperature Derating Graph" on page 6–5

b. Derating occurs below 206 V.

## AC Transfer Specifications

**NOTE:** All transfer specifications are at nominal conditions: ambient temperature of 25 °C, 230 VAC, 50 Hz input, unless otherwise specified.

	All Models
Transfer time—utility to invert	< 20 ms
Relay current rating	30 A
Minimum AC input voltage for transfer	170 VAC RMS
Maximum AC input voltage for transfer	270 VAC RMS
Minimum AC input frequency for transfer	40 Hz
Maximum AC input frequency for transfer	70 Hz
Cooling	Fan-cooled, temperature controlled.

## Physical Specifications

	SW 2524 230	SW 4024 230	SW 4048 230
L × W × H	387×343×197 mm	387×343×197 mm	387×343×197 mm
Net Weight	28 kg	34.5 kg	34.5 kg

# Environmental Specifications

	<b>All Models</b>
Nominal ambient temperature	25 °C
Operating temperature range	-20 to 60 °C, starts derating above 25 °C (see following graph)
Storage temperature range	-40 to 85 °C
Humidity: Operation/Storage	≤ 95% RH, non-condensing
Ingress protection rating	Indoor only, IP 20
Pollution degree	3
Over voltage category (AC circuits)	CAT III
Over voltage category (DC system)	CAT II
Altitude: Operating	2,000 m
Mounting	wall mount using installation bracket

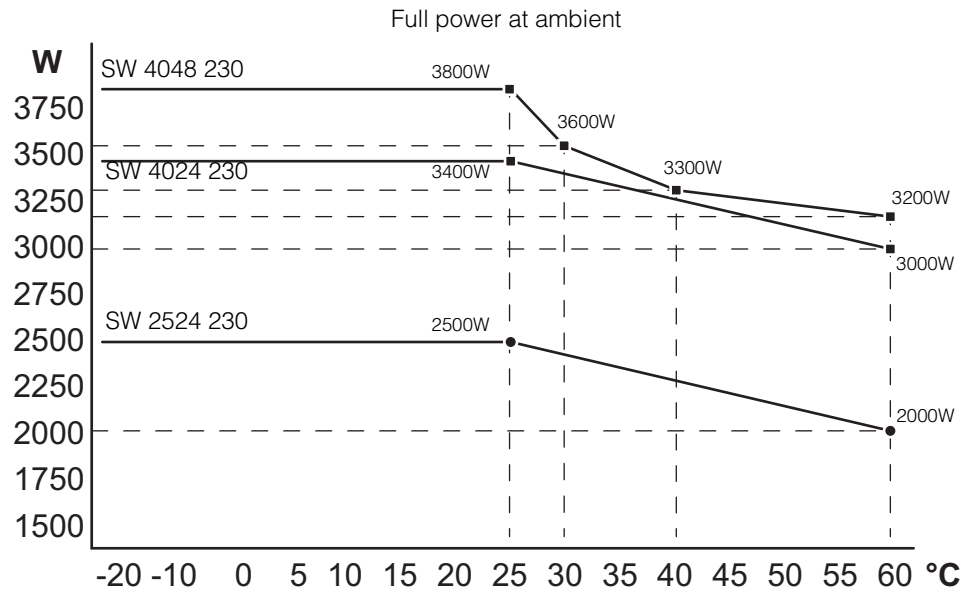

**Figure 6-1** Inverter Output Power versus Temperature Derating Graph

## Regulatory

**NOTE:** Regulatory certifications may change without notice. To see the latest information, visit [solar.schneider-electric.com](http://solar.schneider-electric.com).

	Europe	Australia/New Zealand
<b>Safety</b>	CE marked for the Low Voltage Directive 2006-95-EC per: <ul style="list-style-type: none"> <li>• IEC/EN 62109-1, Safety of power converters for use in photovoltaic power systems – Part 1: General requirements.</li> <li>• IEC/EN 62109-2, Safety of power converters for use in photovoltaic power systems – Part 2: Particular requirements for inverters</li> <li>• IEC/EN 60529-1</li> </ul>	RCM marked per: <ul style="list-style-type: none"> <li>• IEC/EN 62109-1, Safety of power converters for use in photovoltaic power systems – Part 1: General requirements.</li> <li>• IEC/EN 62109-2, Safety of power converters for use in photovoltaic power systems – Part 2: Particular requirements for inverters</li> <li>• IEC/EN 60529-1</li> </ul>
<b>EMC</b>	CE marked for EMC Directive 2004-108-EC per: <ul style="list-style-type: none"> <li>• EN 61000-3-2</li> <li>• EN 61000-3-3</li> <li>• EN 61000-6-3 (generic residential EMC emissions)</li> <li>• EN 61000-6-1 (generic residential EMC immunity)</li> </ul>	RCM marked per AS/NZS 61000.6.3, EMC generic emission standard for residential, commercial and light-industrial environments



# Index

## Numerics

2-stage charge mode 17

## A

ABS Finish 12  
Absorption 12  
absorption charging stage 16  
AC bypass 5  
AC settings menu  
    description 22  
AC Support 12  
AC support menu  
    description 23  
ACGood 12  
Adjustable frequency 3  
Advanced menu 5  
automatic generator start 11

## B

battery equalization 17  
Battery power 5  
battery type 7, 13, 14  
Bulk 12  
bulk charging stage 15

## C

Charger Block, start and stop 18  
charger settings menu  
    description 13  
charging  
    battery temperature sensor 4  
    built-in charge formulas 4  
    dead battery 4  
    equalization 4  
    load management 4  
custom battery menu 19, 21

## D

default settings, restoring 32  
Down arrow button 8

## E

Enter button 8  
equalize charging 17  
equalize mode 12

Exit button 8

## F

fault/warning LED (Xanbus System Control Panel) 8  
Float 12  
float charging stage 16

## H

High surge capacity 3

## I

Information about Your System form ii  
Invert 12  
inverter  
    serial number ii  
Inverter Block, start and stop 12  
inverter settings menu  
    description 7, 9

## K

keypress for system standby mode 9

## L

LdSenseActv 12  
Load Shave 12

## M

meters screen 14  
Multiple Unit Configuration  
    multi unit menu screen 29  
Multi-stage charging 3

## N

no float charging stage 17  
NoFloat 12

## P

Power factor correction 3  
Power Share 6  
proof of purchase ii

## Q

qualifying AC 12

**R**

restore default settings 32

**S**

Schneider Electric

web site iv

search mode 16, 9, 10, 11

serial number ii

standby button 8, 9

system home screen 10

system standby mode 9

**T**

Temperature-controlled 3

troubleshooting

general guidelines 2

motor loads 3

problem loads 3

resistive loads 3

True Sine Wave output 3

two-stage charge mode 17

**U**

Up arrow button 8

**X**

Xanbus SCP

device setup menus 13

features 8

select device menu 13

Xanbus-enabled 3



## Schneider Electric

[solar.schneider-electric.com](http://solar.schneider-electric.com)

As standards, specifications, and designs change from time to time, please ask for confirmation of the information given in this publication.

© 2015 Schneider Electric. All rights reserved.

975-0636-01-01 Rev D

Printed in China