



## UCM

(Universal Communication Module)

For IPN™ Network compatible charge controllers

INSTALLATION AND OPERATION MANUAL



THIS MANUAL INCLUDES IMPORTANT SAFETY INSTRUCTIONS FOR MODEL: UCM  
SAVE THESE INSTRUCTIONS



**TABLE OF CONTENTS**

<b>IMPORTANT SAFETY INSTRUCTIONS</b> .....	2
<b>PRODUCT DESCRIPTION</b> .....	2
Part Numbers .....	2
<b>UCM CONNECTION TO THE IPN NETWORK</b> .....	3
<b>CONNECTING TO THE UCM’S WEB SITE</b> .....	3
UCM Direct Computer Connection .....	4
UCM Connection Using a Router .....	6
UCM Connection Over the Internet .....	7
<b>USING THE UCM’S WEB SITE</b> .....	7
Changing Settings and Executing Functions .....	9
Using the IPN ProRemote with a UCM .....	9
TOP Web Page .....	9
ADVANCED DISPLAY Web Page .....	10
SETUP Web Page .....	11
BATTERY CHARGE PARAMETERS Web Page .....	12
UCM SETUP Web Page .....	13
<b>DATALOGGING</b> .....	13
Datalog Record Time Period .....	13
Datalog File Contents .....	14
<b>FTP</b> .....	14
FTP Communication Settings .....	15
FTP File Contents .....	15
<b>MODBUS</b> .....	15
Electrostatic Handling Precautions .....	15
MODBUS Over TCP .....	15
Slave Address / Unit Identifier .....	16
Isolated RS-485 .....	16
RS-485 Serial Communication Settings .....	15
Supported MODBUS Functions .....	16
Read Coils .....	16
Read Input Registers .....	17
Preset Single Register .....	17
Force Coils .....	18
<b>UCM SETUP PARAMETERS</b> .....	19
As Shipped Factory Default Settings .....	19
Restoring As Shipped Factory Default Settings .....	19
<b>MOUNTING</b> .....	20
<b>TROUBLESHOOTING GUIDE</b> .....	21
<b>SPECIFICATIONS</b> .....	22
<b>FIVE YEAR LIMITED WARRANTY</b> .....	23
<b>TABLES AND FIGURES</b>	
Table 1    Datalog File Data Descriptions .....	14
Table 2    FTP File Data Descriptions .....	15
Table 3    RS-485 Baud Rate and Parity Select .....	16
Table 4    Read Coils .....	16
Table 5    MODBUS Registers .....	17 & 18
Table 6    Force Coils .....	18
Figure 1    UCM Connections and Indicators .....	3
Figure 2    IPN Network & Power Cable Schematic .....	3
Figure 3    Crossover & Straight Thru Ethernet Cables .....	4
Figure 4    UCM DIP Switch and Jumper Settings .....	16
Figure 5    Detailed Dimensional Drawing .....	20

**IMPORTANT SAFETY INSTRUCTIONS**

**This manual contains important instructions for Model: UCM - SAVE THESE INSTRUCTIONS**

1. Refer installation and servicing to qualified service personnel. Incorrect installation or use may result in risk of electric shock or fire. No user serviceable parts in this unit.
2. To reduce the risk of electric shock, fire or personal injury, the following symbols are placed throughout this manual to indicate dangerous conditions, or important safety or operational instructions.

WARNING	CAUTION	IMPORTANT
		
Indicates dangerous conditions or electric shock potential. Use extreme caution.	Indicates items critical to safe installation or operation of the unit.	Follow these instructions closely for proper operation of the unit

3. PERSONAL PRECAUTIONS
  - a) Working in the vicinity of lead-acid batteries is dangerous. Batteries produce explosive gasses during normal operation.
  - b) To reduce risk of battery explosion, follow these instructions and those published by battery manufacturer and manufacturer of any equipment you intend to use in vicinity of battery.
  - c) Someone should be within range of your voice or close enough to come to your aid when you work near a lead-acid battery.
  - d) Have plenty of fresh water and soap nearby in case battery acid contacts skin, clothing or eyes.
  - e) Wear complete eye protection and clothing protection. Avoid touching eyes while working near battery.
  - f) If battery acid contacts skin or clothing, wash immediately with soap and water. If acid enters eye, immediately flood eye with running cold water for at least 10 minutes and get medical attention immediately.
  - g) NEVER SMOKE or allow a spark or flame in vicinity of battery.
  - h) Be extra cautious to reduce risk of dropping metal tool onto battery. It might spark or short circuit battery or other electrical part that may cause explosion.
  - i) Remove personal metal items such as rings, bracelets and watches when working with a lead-acid battery. A lead-acid battery can produce a short circuit current high enough to weld a ring or the like to metal, causing a severe burn.
  - j) Remove all sources of power, photovoltaic and battery before servicing or installing.
4. UCM LOCATION & INSTALLATION
  - a) Unit is not water tight. Do not expose to rain, snow or excessive moisture.
  - b) Unit is designed to be used only with Blue Sky Energy Integrated Power Net™ (IPN™) compatible charge controllers and accompanying displays. Do not attach IPN NETWORK connector to anything other than an IPN compatible communications port.
  - c) Ethernet connector is designed for use with Ethernet TCP/IP communication only. Do not attach ETHERNET connector to anything other than a 10baseT Ethernet compatible computer or router or similar device via standard RJ-45 connector and wiring.
  - d) MODBUS RS-485 communication port is designed to communicate with other RS-485 communication ports only. Do not attach terminal block to anything other than a standard RS-485 communication port, or to an RS-485 communication port with a common mode voltage differential of greater than ±100V Peak with respect to charge controller battery negative. MODBUS terminals are to be tightened to 2.1 in-lb (0.24 nm).

**PRODUCT DESCRIPTION**

The Universal Communication Module (UCM™) provides a full featured communication bridge or gateway between Blue Sky Energy’s Integrated Power Net (IPN™) based charge controllers and external systems The UCM may be used with any IPN compatible charge controller (lower case “i” in the part number, e.g., SB3024iL) and receives both power and IPN network communication from the charge controller. The UCM then provides multiple standard communication interfaces which may be used simultaneously. These standard communication interfaces allow easy access to data and setup parameters for all charge controllers on the IPN network. If an IPN ProRemote display is present its full featured battery system monitoring functionality and associated setup become available as well. Ethernet connectivity includes a built in HTTP web site server allowing data view and parameter setup with a standard web browser either locally or globally over the Internet without a subscription. The ability to provide periodic real time FTP data upload to a remote server is also provided. A standard MODBUS RTU interface is included as well and provided as both isolated RS-485 and Ethernet TCP/IP based MODBUS/TCP. In addition the UCM also provides 128 days (or shorter periods) of datalogging of key performance parameters available as downloadable Microsoft® Excel® compatible file stored in nonvolatile memory.

**PART NUMBERS**

- UCM.....Universal Communication Module, supplied with one each of the following
- 910-0003-03.....3 foot (0.9m) red Ethernet crossover cable
- 910-0002-07.....7 foot (2.1m) IPN network cable
- 430-0030 ..... UCM Operators Manual

**UCM CONNECTIONS AND INDICATORS**



**FIGURE 1**

**Ethernet connector:**

Connects to router with Cat-5 patch cable, or directly to computer with supplied *crossover* type Ethernet cable. **LINK** LED indicates communication link established. **ACT** LED indicates communication activity occurring.

**IPN Network connector:**

UCM power & IPN network communication. **MUST** be connected to properly powered IPN compatible charge controller for UCM to operate.

**Power / Heartbeat indicator:**

Green LED indicates the UCM is powered by an accompanying charge controller. LED blinks when UCM is alive and operating.

**MODBUS RS-485 terminal block:**

Electrically isolated Full or Half Duplex RS-485 serial port for connection to MODBUS master. **RX** and **TX** LED's indicate Transmit or Receive is occurring.

**UCM CONNECTION TO THE IPN NETWORK**

Connect the UCM's IPN NETWORK jack to the charge controller's IPN DISPLAY jack using the supplied 4-pin telephone cable. If more than one charge controller is present the UCM may plug into any charge controller on the network. The charge controller must have proper battery power attached for the UCM to receive power and operate. The UCM's Power/Heartbeat indicator will blink when properly connected to and powered by the accompanying charge controller.



➤ Standard 4-pin telephone cables swap pin numbers end-to-end. If cables are custom terminated or cable couplers are used be certain the proper pin swap is maintained. If a telephone splitter is required to attached both a display and a UCM to the same charge controller use a 1-male to 2-female splitter plugged into the charge controller to maintain proper pin swap.

**IPN NETWORK & POWER CABLE SCHEMATIC**

Standard 4-pin telephone cable pin swap

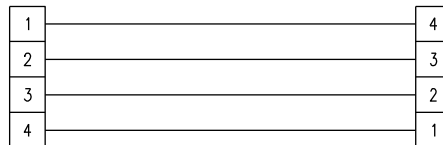

**FIGURE 2**



➤ **CAUTION:** Only one UCM may be present on the IPN network. Do not plug the UCM's IPN network connector into anything other than an IPN-compatible charge controller or damage may result which will void the limited warranty. The UCM may consume up to 1W of power from the charge controller with Ethernet communication operating. Total maximum cable length should be limited to approximately 75 feet (22.3m) with 28 awg cable or 300ft with 22 awg cable.

**CONNECTING TO THE UCM'S WEB SITE**

The primary means of communicating with the UCM is through its built in web site server which provides access to all data and setup parameters for both the UCM and charge controller(s), and provides access to the datalog file. The UCM may connect directly to a computer without a router, be accessed from computers on your LAN using a standard router, or be accessed over the Internet by configuring your router for port forwarding. The UCM web site server can support 2 users simultaneously.



➤ A **direct connection** between the UCM and a computer using the supplied *crossover* type cable will likely be necessary to configure UCM communication settings. A direct connection to a computer without a router is the easiest method confirm UCM operation and communicate with the UCM to configure communication settings while eliminating possible communication issues relating to UCM or router setup. The supplied crossover cable is **RED** in color and the word **XOVER** is present on both cable connectors to make this special cable readily identifiable from other non-crossover type cables. Signal names and typical wire colors for a straight-thru patch cable and special *crossover* cable are shown in Figure 3.

**CROSSOVER & STRAIGHT-THRU ETHERNET CABLES**

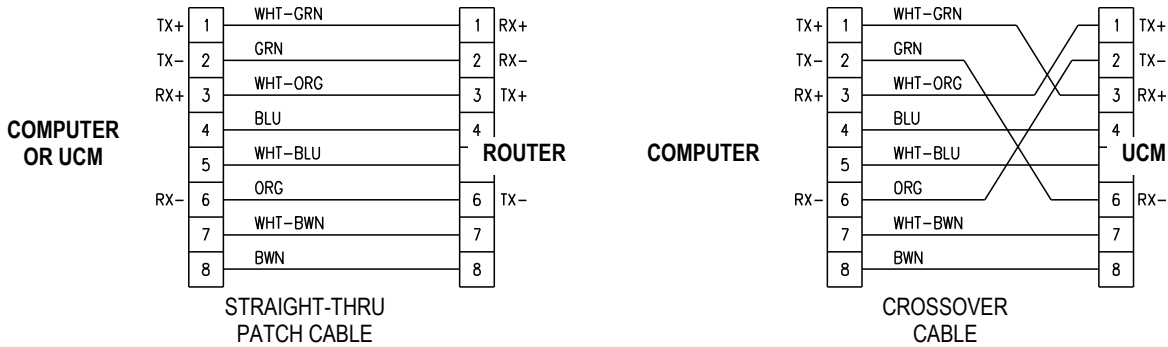

**FIGURE 3**



➤ **CAUTION:** Do not plug the UCM’s Ethernet connector into anything other than a 10baseT Ethernet compatible computer, router or similar 10baseT Ethernet compatible device or damage may result which will void the limited warranty. Utilizing good wiring practices total maximum cable length should be limited to 329 feet (100m).

**UCM DIRECT COMPUTER CONNECTION**

This option allows a single computer to directly connect to the UCM without a router or internet access. Direct connection is the simplest means to communicate with the UCM and will likely be required to access and configure communication settings for UCM access via a router or over the Internet.

**1) Connect UCM to powered charge controller with 4-pin telephone cable supplied**

Confirm heartbeat/power LED is blinking indicating charge controller is powered and UCM is powered and operating.

**2a) Windows XP — Configure computer’s TCP/IP settings for direct connection with UCM**

For Windows XP operating system go to *Control Panel, Network Connections*, and select *Properties* for the LAN Hardware device. From the *Local Area Connection Properties* window select *Internet Protocol (TCP/IP)* and select *Properties*. Record the present *Internet Protocol (TCP/IP) Properties* settings for subsequent restoration which will likely be *Obtain an IP Address Automatically* and *Obtain DNS Server Address Automatically*. Enter the *Internet Protocol (TCP/IP) Properties* settings shown below and select OK and then OK again to exit the *Local Area Connection Properties* window. There may be some delay as the computer reconfigures TCP/IP communications.

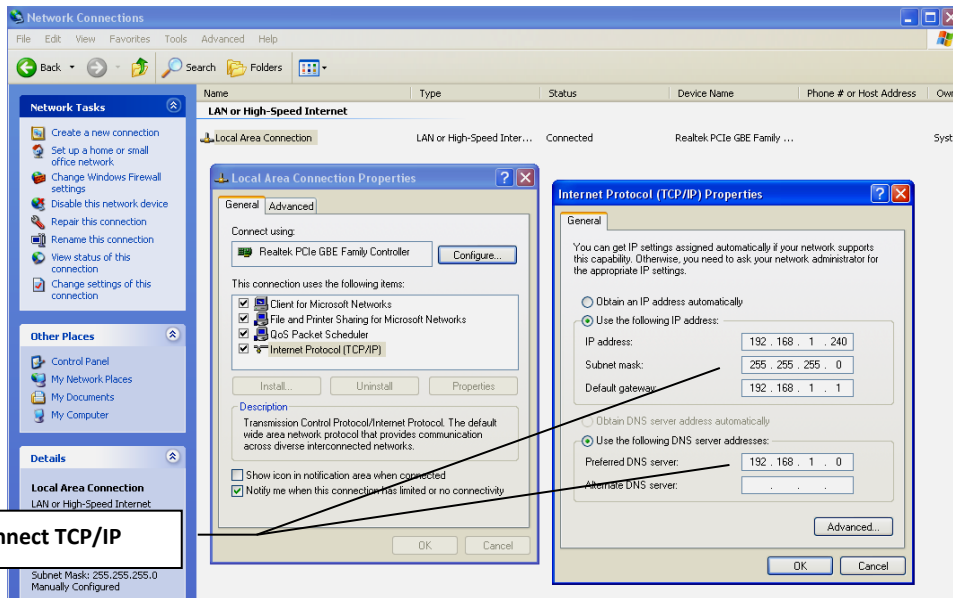

**2b) Windows 7 – Configure computer's TCP/IP settings for direct connection with UCM**

For Windows 7 operating system go to *Control Panel*, and under *Network and Internet* category select *View Network Status and Tasks*. From within the *Network and Sharing Center* window that appears select *Change Adapter Settings*. Right click on *Local Area Connection* and select *Properties*. In the *Local Area Connection Properties* window that appears select *Internet Protocol Version 4 (TCP/IPv4)* and then select *Properties*. Record the present *Internet Protocol Version 4 (TCP/IPv4) Properties* settings for subsequent restoration which will likely be *Obtain an IP Address Automatically* and *Obtain DNS Server Address Automatically*. Enter the *Internet Protocol Version 4 (TCP/IPv4) Properties* settings shown below and select OK. You will be presented with a warning "Warning - Multiple default gateways...". Select Yes and Close to exit the *Local Area Connection Properties* window. There may be some delay as the computer reconfigures TCP/IP communications.

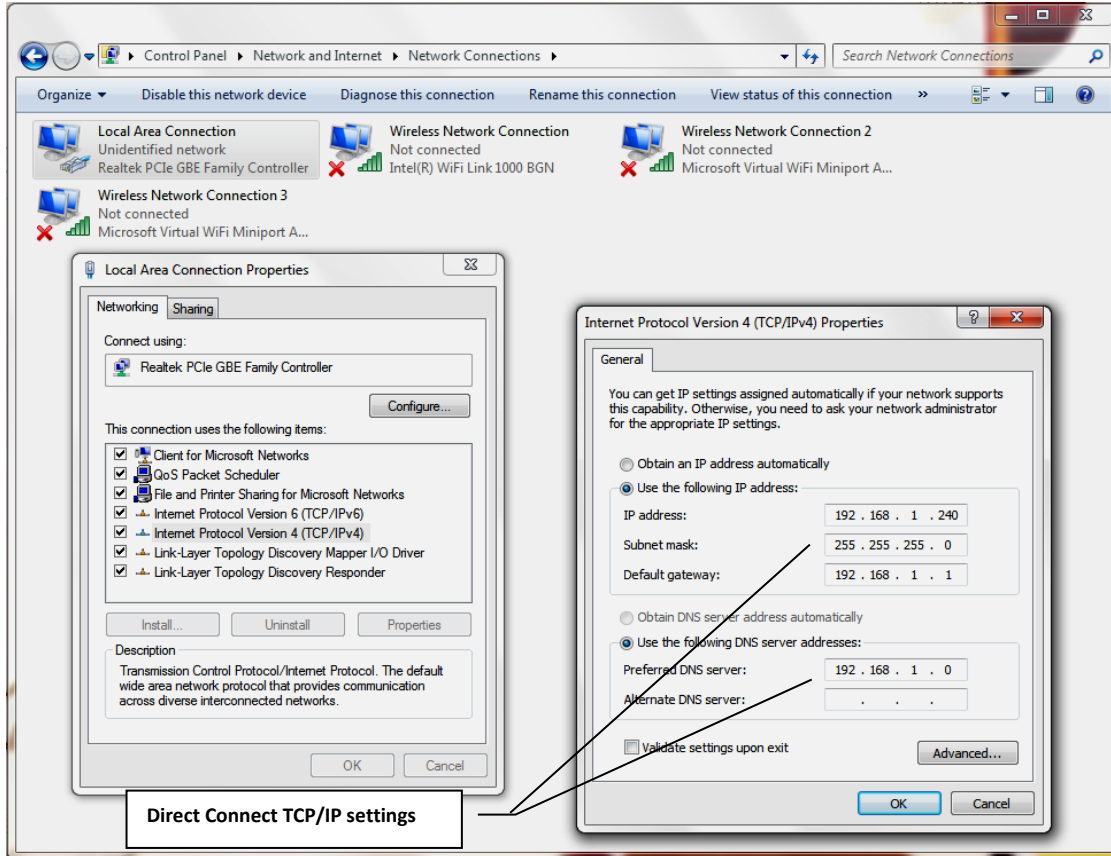

**2c) Other systems – Configure computer's TCP/IP settings for direct connection with UCM**

For other operating systems including Windows Vista enter the same equivalent settings changes per 2a or 2b as described in the operating system documentation.

**3) Connect UCM to computer with crossover cable supplied**

Confirm LINK LEDs on UCM's Ethernet connector and on the computer's Ethernet connector are both ON indicating a communication link is established between computer and UCM. A *crossover* type cable supplied with the UCM must be used for direct connection to a computer.

**4) Logon to the UCM's web site & Record UCM's MAC ID**

Enter the UCM's IP Address into your web browser. The UCM uses a fixed IP Address with a factory default of **192.168.1.235** which may be changed if desired on the *UCM Setup* page. For Windows Internet Explorer enter the web address in the form; <http://192.168.1.235>

You should be presented with the UCM's password logon screen as shown below which confirms UCM operation and communication. To logon to the UCM web site enter the default password **admin** and select *Submit* and then *Enter Remote* to get to the UCM's *Top Menu* web page. Select the *UCM Setup* page to view the MAC ID which is unique to this particular UCM and record the MAC ID for later use. If you are unable to get to the password screen because the IP Address or other UCM communication settings have been changed you may restore all UCM defaults by performing a *Restore As Shipped Factory Defaults* function.

UCM MAC ID: \_\_\_\_\_ (unique to this particular UCM)



### 5) **Restore computer TCP/IP settings to their original settings**

When finished with direct connect communication restore the computer's original *Internet Protocol (TCP/IP) Properties* settings recorded above which are likely *Obtain an IP Address Automatically* and *Obtain DNS Server Address Automatically*. If these settings are not restored the computer will not be able to communicate with a hard wired connection to the router or the internet. Be certain to reconnect the computer to the router with a standard patch cable as the *crossover* cable supplied with the UCM will not work for this purpose unless the router can detect and correct for a *crossover* type cable.

## UCM CONNECTION USING A ROUTER

This option allows one or more computers to connect to the UCM via your router and LAN (Local Area Network). Special communication settings may be required in the UCM, router, or both to allow UCM access over your LAN. Computers on your LAN must be able to communicate with the UCM through the router before attempting to communicate with the UCM over the Internet.

### 1) **Connect UCM to powered charge controller with 4-pin telephone cable supplied**

Confirm heartbeat/power LED is blinking indicating charge controller is powered and UCM is powered and operating.

### 3) **Connect UCM to ROUTER**

Connect UCM to an available port on the Router with a user supplied standard CAT-5 network patch cable. The *crossover cable* supplied with the UCM cannot be used for this purpose and a straight-thru cable is required unless the router can detect and correct for a *crossover* type cable. Confirm the LINK LED on UCM's Ethernet connector is ON and the Router's link active indication for the port being used is ON indicating a communication link is established between the Router and UCM.

### 2a) **Attempt to logon to the UCM's web site**

From a computer attached to the Router enter the UCM's IP Address into the web browser. The UCM uses a fixed IP Address with a factory default IP Address of **192.168.1.235** which may be changed if desired on the UCM Setup page. For Windows Internet Explorer enter the web address in the form;

<http://192.168.1.235>

If you are presented with the UCM's password logon screen as shown above the UCM is communicating across your LAN and further router or UCM setup for LAN communication is unnecessary. If you are unable to get to the password screen because the IP Address or other UCM communication settings may have been changed, perform a *Restore As Shipped Factory Defaults* function and try again.

### 2b) **Modify router configuration if necessary and logon to the UCM's web site**

If you are still unable to get to the password screen the UCM and/or router may require special settings to allow the router to communicate with the fixed IP Address UCM. Refer to the router's documentation regarding communication setup for fixed IP Address devices. However, many routers require two things be changed, 1) Change the UCM's IP Address to be within the IP Address range the router can assign via DHCP, and 2) Add the new UCM IP Address to the routers *DCHP Reservation* list to reserve the UCM's new IP Address for exclusive use by the UCM.



➤ A **direct connection** between the UCM and a computer using the supplied *crossover* cable as described previously is necessary to configure UCM communication settings including the IP Address. If you are unable to get to the password screen because communication settings in the UCM have been changed you can temporarily force the UCM to use default communication settings by rebooting the UCM with DIP #4 **IP-A** turned ON. This special communication mode will temporarily show and use default communication settings on the UCM Setup page. If no changes are made at this time, previous changes made to these settings will return following reboot with DIP #4 OFF. If settings changes are made at this time such as changing the IP Address the new settings will be used following reboot with DIP #4 OFF You may also restore all UCM defaults including communication settings and password by performing a *Restore As Shipped Factory Defaults* function.

Record the UCM's new IP Address for later use.

UCM IP Address: \_\_\_\_\_

This typically requires that you go to the routers *DCHP* status or setup page to see the IP Addresses that the router has assigned to computers or other devices on your LAN via DCHP (Dynamic Host Configuration Protocol). IP Addresses are four numbers separated by periods and may be something like 192.168.0.xxx where xxx must be different for each device on your LAN. DCHP typically increments the xxx portion of the IP Addresses it assigns so that complete IP Addresses for devices presently on your LAN in this example may be 192.168.0.3 , 192.168.0.4 , 192.168.0.5, etc. A common requirement among routers is that all IP Addresses must have the same first three number segments. You should therefore set the UCM's IP Address on the *UCM Setup* page to the same first three number segments set by the router for other addresses, and the fourth number segment must within the IP Address range the router can assign via DCHP and be different than all others assigned by DCHP. A complete UCM IP Address in this example may be 192.168.0.15. The final step is to reserve the UCM's new IP Address in the router for exclusive use by the UCM by entering the UCM's new IP Address (and MAC ID if necessary) into the routers *DCHP Reservation List*.

### UCM CONNECTION OVER THE INTERNET

Once UCM communication via your LAN and router is successful, communication with the UCM over the internet is possible. Access over the Internet is essentially accomplished by opening Port on the router to allow computers on the Internet to access the UCM through a process referred to as *Port Forwarding*.

#### 1) **Connect UCM to router**

Connect UCM to router and configure UCM and router for UCM communication across the LAN.



➤ Connecting to the UCM across the Internet is not possible unless the UCM and router are properly configured to allow UCM access by other computers on the LAN. Confirm UCM web site is accessible by computers on the LAN attached to your router before proceeding. See *UCM CONNECTION USING A ROUTER*.

#### 2) **Configure Router for Port Forwarding**

Port forwarding allows remote computers on the Internet to access a device on your LAN with particular a IP Address, in this case the UCM. As described in your routers documentation, enable *Port Forwarding* in the router for the UCM's IP Address and MAC ID. Some routers may refer to port forwarding as a *Virtual Server* or *Gaming*. Set the Port type or number to *HTTP* or port *80* (port 80 is the default for an HTTP server).

#### 3) **Test Internet Access Using Routers IP Address**

The routers IP Address on the Internet (or WAN - Wide Area Network) is not fixed but rather is dynamically assigned by the ISP (Internet Service Provider) when the router logs onto the ISP's WAN. Refer to your routers documentation regarding how to determine the present WAN IP Address assigned to your router by the ISP. This varies by router but is typically available by selecting a *WAN Status* or *Internet Status* or similar button from the routers setup web page to view the WAN IP Address presently assigned to your router by the ISP.

Suppose for example that the ISP assigned your router a WAN IP Address of **76.321.125.30**. To access the UCM web site from any computer on the Internet using Windows Internet Explorer enter the web address in the form;

<http://76.321.125.30>

You should be presented with the UCM's password logon screen which confirms the UCM is available over the Internet. To logon to the UCM web site enter the password (default **admin**) and select *Submit* and then *Enter Remote* to get to the UCM's *Top Menu* web page.



➤ The WAN IP Address of your router and therefore the IP Address you use to access the UCM over the Internet is not fixed and may change if the ISP chooses to reassign your routers WAN IP Address. If UCM access via entering the WAN IP Address stops working, check to see if your router has been assigned a new WAN IP Address by your ISP.

#### 4) **Setting Up A Domain Name**

While entering the WAN IP Address of your router into a web browser is a suitable method for accessing the UCM over the Internet you may wish to setup a Domain Name such as [mysolar.net](http://mysolar.net) to access the UCM. This is done by a process referred to as DNS (Domain Name System). DNS is like a phone book that translates a domain name ([mysolar.net](http://mysolar.net)) to an IP Address (76.321.125.31). DNS allows you to enter a domain name and then be automatically redirected to your routers WAN IP Address and the UCM.

Blue Sky Energy does not provide DNS service (or endorse any particular DNS service), but there are variety of DNS providers both free and paid. One such DNS service is available at [www.dyndns.com](http://www.dyndns.com) which provides both free and low cost DNS service. Generally a free service may have limited DNS features, whereas additional features with a paid service may include keeping track of your routers WAN IP Address it changes so that your domain name (e.g., [mysolar.net](http://mysolar.net)) will always get you to the UCM. Refer to the DNS service providers setup and use instructions for assigning and managing a domain name of your choice.

### USING THE UCM'S WEB SITE

Enter the UCM's IP Address into your web browser from a direct connect computer or a computer on the LAN. From a remote computer on the internet enter the WAN IP Address assigned to your router by your ISP, or a user established domain name from a DNS service. You should be presented with UCM password login page. The UCM can support two separate web site users simultaneously.



➤ **WARNING:** Avoid using the UCM to enter settings that may lead to unsafe operation of the charging system. Refer to charge controller and display operators manuals regarding setup and operation of these products. Set battery charge parameters to values specified by the battery manufacturer.



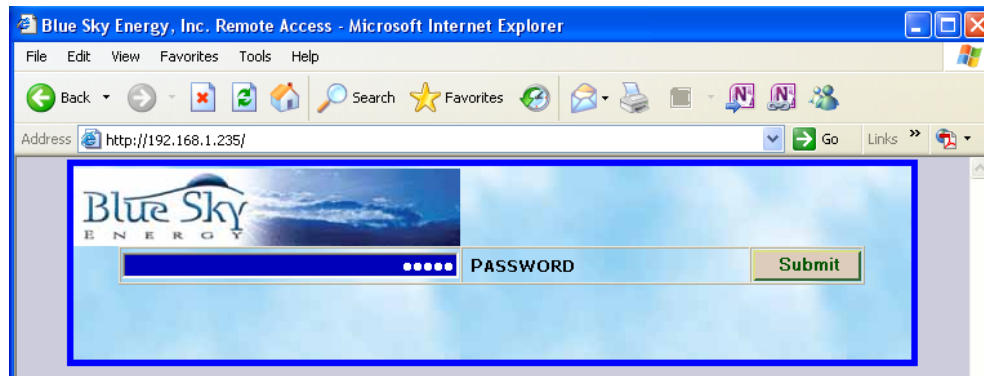

Enter the password and select *Submit*. Default password is **admin**. If the password is accepted you will be presented with an *Enter Remote* button.



Select *Enter Remote* to go to the Top Menu page.

Once logged onto the UCM's web site there are five available pages. The first four pages are essentially the same as the four menus of the IPN ProRemote. The fifth page, UCM Setup, is for configuring UCM communications and password settings. Excluding the preceding password logon pages the following pages are available and may be selected from any page. To provide up to date information while minimizing data transfer the UCM Top web page will automatically refresh every 15 seconds with all other pages automatically refreshing in 4 minutes. If the web browser's "Refresh" button is used to refresh a page manually the automatic refresh function is halted. To restart the automatic refresh function you must exit the page and reenter it.

- **Top**
- **Advanced Display**
- **Setup** (charge controller and battery monitor setup)
- **Battery Charge Parameters**
- **UCM Setup**

Items shown on the web pages are either informational data which display in Green, or settings that the user can change which display in Blue. The display convention used throughout the UCM is that if a data or setup item is unavailable dashes (— —) will be displayed.

#### CHANGING SETTINGS AND EXECUTING FUNCTIONS

Changing a setting is accomplished by entering the desired value into the appropriate Blue setting box and then pressing the appropriate *SET* button to send the change command to the charge control system. Clearing an amp-hour counter or Starting/Stopping equalize is accomplished in a similar manner by pressing the appropriate *START*, *STOP* or *CLEAR* button to send the desired command.



➤ **CAUTION:** User settable values in Blue displayed with a decimal point must have new values entered with the decimal point as well. If the Absorption charge voltage setpoint is changed from 14.4V to 14.0V the new value must be entered as 14.0 not as 14. If 14 was entered rather than 14.0 the setpoint will become 1.4V. Do not enter text into numeric settings or unusual numeric values will appear. After entering a new setting you must press *SET* to send the new value to the charge control system. Refer to appropriate operators manual for further detail regarding remote equipment operation and settings.

➤ **CAUTION:** After a *SET*, *START*, *STOP* or *CLEAR* command is sent to the charge control system the UCM web page will automatically refresh in 3 seconds to retrieve the new setting stored in the charge control system and clear the command information from the web address bar. Do not press the web browser's Refresh button during this 3 second period or the command will be resent. Do not use the browser BACK button to return to previous UCM pages or commands may also be resent. After the 3 second automatic refresh has taken place, press the web browser *Refresh* to once again reload the page with the very latest data and confirm that the desired setting change or command action has been executed.

**USING THE IPN ProRemote WITH A UCM**

An IPN ProRemote display may or may not be present in the system. If an IPN ProRemote is present its full featured battery monitoring functionality become available through the UCM. If an IPN ProRemote is not present its battery system monitoring data; Net Battery Amps, Amp-Hours From Full, % Remaining, and its setup items; Battery Amp-Hours, Charge Efficiency, Charge Efficiency Mode and Self Discharge Rate will be unavailable and display as dashes (----). Refer to the IPN ProRemote operators manual for detail regarding the IPN ProRemote’s functionality and settings.



➤ **CAUTION:** An IPN ProRemote used with the UCM must have software version V4.00 or later. Earlier versions will cause communication conflicts with the UCM leading to improper operation of certain UCM commands or settings. The user may upgrade IPN ProRemote software in the field by purchasing and installing a new microprocessor as described in Technical Bulletin 100212. The latest IPN ProRemote software may be purchased as part number 590-0002-01.



➤ Since both the UCM and IPN ProRemote can change the same parameters (e.g., Battery Amp-Hours) it is important to refresh the appropriate display to view the latest setting. For example if a change is made to Battery Amp-Hours with the ProRemote the change will not appear on the UCM until the page showing Battery Amp-Hours is refreshed. Similarly, if the same change was made from the UCM while the IPN ProRemote was displaying the Battery Amp-Hour screen the new value will not appear on the IPN ProRemote until that screen is exited and re-entered to refresh the value.

➤ With the UCM numeric settings may be set to any number within an allowed range. Since the IPN ProRemote does not have a numeric keypad many numeric settings are changed in larger increments to speed operation. For example Battery Amp-Hours is changed in steps of 10 amp-hours with the IPN ProRemote (200, 210, 220, etc.). If the UCM was used to set Battery Amp-Hours to 201 amp-hours, the IPN ProRemote will show the new setting of 201 amp-hours. If Battery Amp-Hours was subsequently changed on the IPN ProRemote the setting would increment in 10’s from the present setting (201, 211, 221, etc.). This is not necessarily a problem, but may be corrected from the IPN ProRemote by changing the setting to the minimum value and then raising the setting to the desired value.

**TOP WEB PAGE**

FLOAT	Charge Mode	
13.2	Battery Volts	
+3.8	Net Battery Amps	
+11.3	Sum of Input Amps	
+29.8	Sum of Output Amps	
100	% Remaining Battery Capacity	
0	Battery Amp-Hrs from Full	
13.0	Auxiliary Battery Volts	
ON	Auxiliary Charge Status	
----	Load Control Status	
15.2	Equalize Volts, Equalize Now	Start
----	Equalize Minutes Remaining	

- Web page selector buttons.
- User defined Location Name reminder.
- Battery voltage from charge controller.
- Net battery current from IPN ProRemote.
- Sum of input and output current for all charge controllers on the IPN network.
- Amp-Hours from full & % Remaining Battery Capacity from IPN ProRemote. Dashes (----) are shown until the first time the battery is fully charged by the charge controller.
- Auxiliary battery voltage and charge status when charge controller set for Auxiliary
- Load control status when charge controller set for load control or lighting control.



**WARNING:** Not all batteries can be safely equalized. Always follow battery manufacturers recommendations pertaining to equalization. Selecting *START* starts the equalization cycle unless equalize is disabled in the charge controller. Equalize continues until equalize “time at voltage” time accumulator counts down to zero minutes left, or equalize is manually canceled with *STOP*. **Note:** The voltage shown is the basic equalize setpoint and does not include the effects of temperature compensation.

ADVANCED DISPLAY WEB PAGE

The screenshot shows the 'Advanced Display' page of the Blue Sky Energy Remote Access system. It features a navigation menu with 'Advanced Display', 'Setup', 'Battery Charge Parameters', and 'UCM Setup'. The main content area displays several key metrics:

- Days Since Last Full Charge: 1
- Days Since Last Equalize: 1
- Max. Battery Voltage Detected: 15.2
- Min. Battery Voltage Detected: 11.6
- Total Charge AMP-HRS: +757
- Lifetime Battery AMP-HRS: -16
- Battery Temperature (C): 26
- Battery Temperature (F): 79

Each of these metrics has a 'Clear' button next to it. Below these metrics is a table showing the status of various units:

Unit	Degrees C	Out Amps	In Volts	In Amps
Master	24	0.2	16.2	0.4
Slave 1	----	----	----	----
Slave 2	----	----	----	----
Slave 3	-55	29.6	0.0	10.9
Slave 4	----	----	----	----
Slave 5	----	----	----	----
Slave 6	----	----	----	----
Slave 7	----	----	----	----

At the bottom, there is a 'Data Logging' section with a 'Hours In Log Period' set to 24.2 and 'Records available' at 0. A 'Download Log File' button is highlighted with a box, and a 'Clear Log' button is also visible.

User defined Location Name reminder.

Days since last full charge or equalize. Equalize day counter resets upon starting equalize.

Day counter accuracy is +1 / -0 days. Day counter transitions occur following each 24 hour period from charge controller boot. Consider rebooting charge controller very late at night to improve perceived accuracy. Maximum range is 255 days which is also shown if days are unknown.

Captures minimum and maximum battery voltage since last cleared.

Captures total output amp-hours of all charge controllers on the IPN network since last cleared.

Serves as battery "odometer" capturing total discharge amp-hours since last cleared. Value computed by IPN ProRemote and saved to IPN ProRemote non-volatile memory once per day.

Present status of all charge controllers on the IPN network. If charge controllers are present in the system and communicating data for that charge controller will be shown. If data is unavailable because a particular charge controller is not installed or not operating dashes ( - - - ) are displayed. (Charge controllers without digital temp sensor always read -55°C.)

Datalog control panel. Shows number of records available, sets time period between datalog records & downloads/clears datalog file. Default time period of 24.2 hours should be used for a desired datalog period of one day. Entering a setting of 0.0 hours disables record collection and return the word DISABLED in the setting box.

Do not press SET with the word DISABLED in the setting box or an unusual numeric value will be entered.

SETUP WEB PAGE

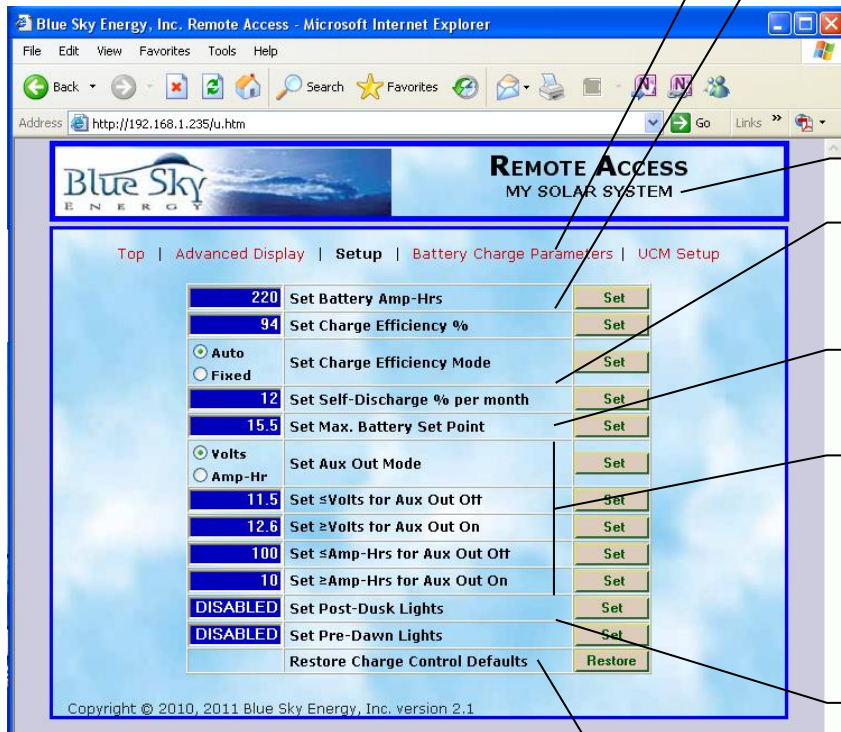

Total battery Amp-Hour rating at 25°C, 20hr rate. Stored in and used by IPN ProRemote.

With charge efficiency set to 94%, battery is expected to retain 94 Amp-Hours for each 100 Amp-Hours of charge delivered. With charge efficiency mode set to *FIXED*, charge efficiency value remains as set. If set to *AUTO* charge efficiency automatically adjusts based on observed battery charge efficiency. Stored and used by IPN ProRemote.

User defined Location Name reminder.

Battery self discharge rate in percent per month at 25°C. Stored and used by IPN ProRemote.

Maximum charge voltage setpoint limit regardless of other settings or temperature

Sets IPN Master charge controller “load control” on/off operation to be based on battery *Volts* or battery *Amp-Hours* from full.

**Note:** Set voltage settings if using amp-hour control as the charge controller will revert to voltage control if battery Amp-Hour information is unavailable.

Enables, disables and sets ON time for lighting control mode. Lighting control mode is disabled if BOTH Post-Dusk and Pre-Dawn timers are set to *DISABLED*. Lighting control mode is enabled if EITHER Post-Dusk or Pre-Dawn timers are set to a numeric time value. Entering a setting of 0.0 hours will disable that particular timer and return the word *DISABLED* in the setting box.

Do not press *SET* with the word *DISABLED* in the setting box or an unusual numeric value will be entered.

Restores as shipped factory default settings in the charge controller(s). IPN ProRemote defaults cannot be restored from the UCM. Refer to charge controller and IPN ProRemote operator manuals.

BATTERY CHARGE PARAMETERS WEB PAGE



➤ **CAUTION:** Refer to charge controller operators manual for further detail regarding charge control operation. Set battery charge parameters to values specified by the battery manufacturer.

14.4	Set Acceptance Charge Volts	Set
13.2	Set Float Charge Volts	Set
15.2	Set Equalize Charge Volts	Set
2.0	Set Equalize Hours	Set
30	Set Auto Equalize Days	Set
-5.00	Set T-Comp Slope mV/°C/Cell	Set
1.5	Set Float Transition Amps/100 Amp-Hours	Set
2.0	Set Acceptance Hours	Set

Absorption charge voltage setpoint.  
Range 10.0 to 80.0V.

Float charge voltage setpoint.  
Range 10.0 to 80.0V.

User defined Location Name reminder.

Equalize charge voltage setpoint.  
Range 10.0 to 80.0V.

Equalize time setpoint.  
Range 0.5 to 10.0 hours.

Days between automatic Equalize. Range is 10 to 400 days. Fully MANUAL equalization is selected by entering a setting of 0 days.

Charge voltage temperature compensation factor. Range is -0.00 to -8.00mV/°C/cell.

Sets Float Transition Current. Range 0.1 to 10.0A per 100 Amp-Hours of battery capacity. A setting of 0.0A disables function such that full charge is based on Absorption charge time only.

Sets Absorption charge time.  
Range 0.0 to 10.0 hours.

UCM SETUP WEB PAGE

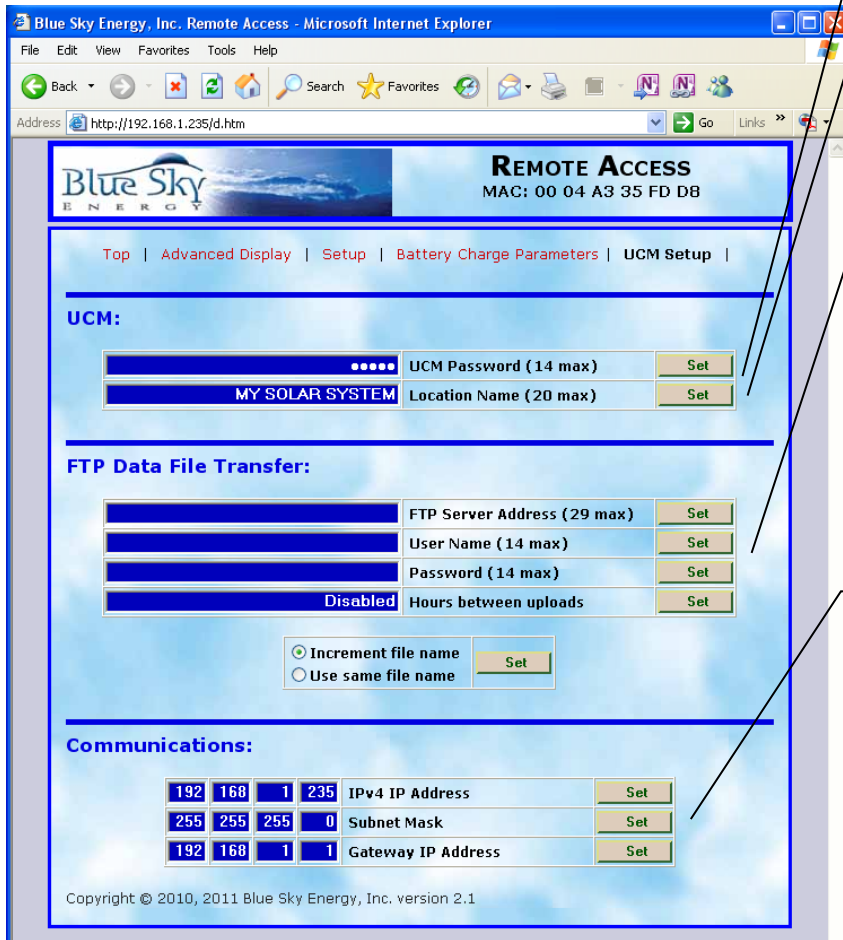

UCM password, required for UCM access. Default password is **admin**.

*Location Name* reminder (e.g., ROAD SIGN #42). Appears below *Remote Access* on all pages except UCM Setup page to remind users of multiple UCM's which particular UCM is being viewed.

FTP communication settings. Factory defaults are shown. FTP used for periodic upload of real-time data to remote server. Setting range 0.0 – 24.0 hours. A setting of 0.0 hours between uploads will disable FTP transfers and return the word DISABLED in the setting box.

Do not press *SET* with the word DISABLED in the setting box.

➤ UCM Ethernet communications settings. See *Connecting To The UCM's Web Site*.

**New settings take effect following UCM reboot.**

To aid setup, the factory default Communication settings shown here will be temporarily used if the UCM is booted with DIP #4 *IP-A* switched ON as shown in Figure 4. While boot with DIP #4 ON uses and displays the default settings shown, changes made either now or previously are retained in memory and will be used following UCM reboot with DIP #4 OFF.

Default settings may also be restored permanently by performing a *Restore As Shipped Factory Default Settings* operation.

**DATALOGGING**

The UCM provides datalogging capability for up 127 complete records, plus one in process record, for up to 32 key performance parameters. Complete datalog records are collected and stored in the UCM's nonvolatile Flash memory and are retained if UCM power is lost. The datalog information is available from the UCM as a downloadable file in a Comma Separated Value (.csv) file format with the default file name **log.csv**. The datalog file may be downloaded from the UCM's web site by selecting *Download Log File* from the UCM's *Advanced Display* web page. A UCM may be taken from the field back to the office for datalog file download but a powered charge controller must be connected to power the UCM. The downloaded datalog file may be viewed or manipulated with any spreadsheet program which accepts the .csv file format including Microsoft Excel. Selecting *Clear Log* will clear all records from the UCM's datalog memory.

**DATALOG RECORD TIME PERIOD**

The time period between datalog records is user selectable and may be set in steps of 0.1 hours (6 minutes) up to a maximum time period of 24.4 hours. A setting of 0.0 hours disables record collection while retaining existing records, and returns the word DISABLED in the setting box. The ability to set record time to widely varying intervals allows system performance to be examined in varying levels of detail as desired by the user.



➤ The actual time period between storing records will be **either**; 1) The log time setting in hours since storing the last record, – **OR** – 2) The charge controller system transitions from a *Charge Off* state to a *Charge On* state, – **whichever occurs first** – **Note:** If weather and low light conditions at the beginning or end of a charging day produce multiple *Charge Off / Charge On* transitions, very short duration "false daily records" will appear. These short duration records typically capture little or no charge and should not be confused with a normal full day record where charge did not occur for some reason. Eliminating these very short duration records will not affect the integrity of the remaining daily records. Examine the record duration (*RecdTime*) for each record in the datalog file to confirm the record is valid for the for the type of system analysis being conducted.



➤ If the desired datalogging is to collect daily records, leave the datalog *Hours In Log Period* at the default setting of 24.2 hours. The one day plus 12 minutes setting assures that as the switch to *Charge On* in the morning moves with time of year or weather the switch to a *Charge On* state will typically be what starts the new record without building up a cumulative time error. Should a PV power failure occur the timer will take over and assure that daily records without the PV system switching to a *Charge ON* state are collected with only a slight cumulative time error as days go by. Due to large shifts of sunrise/sunset time at very high latitudes during March and September, consider using a setting of 24.3 hours at latitudes greater than  $\pm 60^\circ$ .

**DATALOG FILE CONTENTS**

The CSV datalog file as viewed in a spreadsheet such as Excel is organized into rows and columns. Each row is a single datalog record. Each record contains a variety of data values which are presented in columns. If a data value in a record is unavailable that cell will contain dashes (—). Each data item is the minimum, maximum, total, etc., for that data record time period. Spreadsheet column A contains the record number. Record 0 is the present time period record still being collected, -1 is one complete record ago, -2 is two complete records ago, etc., up to 127 complete records. Note that record 0 is an incomplete record which is still in the process of being collected and will show data up to the point in time the datalog file was downloaded. Once the present record 0 time period ends record 0 is stored as record -1, the entire record stack shifts down by 1, and a new record 0 is started. If 127 records are present and a new record is saved, the oldest record is lost. A partial datalog record is shown below.



➤ The first record following charge controller boot may show a maximum PV voltage value (MaxInV) greater than the maximum actually seen during the record period. This is due to the charge controller sending the highest PV voltage it has ever seen for the first 10 seconds following boot which is then captured in the datalog.

	A	B	C	D	E	F	G	H	I	J	K	L	M	N	O	P
		MaxVbat	MinVbat	AccpTime	FloatTime	MaxDscha	MaxDschaH	MinDschaH	MaxTotChgA	RecdTime	#0MaxInV	#0MaxOutA	#0ChgAH	#1MaxInV	#1MaxOutA	#1ChgAH
1	0	14.2	12.2	68	127	-10.5	40	0	15.7	23.9	21.4	15.7	75	--	--	--
3	-1	14.2	12.4	66	268	-21.8	49	0	14.9	24.1	22.1	14.9	73	--	--	--
4	-2	14.2	12	70	256	-23.2	51	0	15.5	23.9	22.1	15.5	78	--	--	--

**DATALOG FILE DATA DESCRIPTIONS**

SPREADSHEET COLUMN	COLUMN HEADING	DESCRIPTION / COMMENTS
A		Datalog record number, older records below newer records
B	MaxVbat	Maximum battery volts
C	MinVbat	Minimum battery volts
D	AccpTime	Total minutes in Absorption charge mode
E	FloatTime	Total minutes in Float charge mode
F	MaxDscha	Maximum net battery discharge amps (negative) — from IPN ProRemote
G	MaxDschaH	Maximum discharge amp-hours from full (negative) — from IPN ProRemote
H	MinDschaH	Minimum discharge amp-hours from full (negative) — from IPN ProRemote
I	MaxTotChgA	Maximum total PV charge amps — sum of all charge controllers on IPN network
J	RecdTime	Actual time period of this record in hours
K	#0MaxInV	Maximum PV volts from Master charge controller — IPN address 0
L	#0MaxOutA	Maximum output amps from Master charge controller — IPN address 0
M	#0ChgAH	Total output amp-hours from Master charge controller — IPN address 0
N	#1MaxInV	Same charge controller voltage, current and amp-hour data as columns K, L & M above, but for charge controller Slave address #1. Additional columns to the right contain the same data for charge controller address #2 - #7.
O	#1MaxOutA	
	#1ChgAH	
P	#1ChgAH	

**TABLE 1**

One of the ways the UCM can be used to monitor system status remotely is through File Transfer Protocol or FTP. The UCM can be configured to send files via FTP to a remote server at timed intervals as a Comma Separated Value (.csv) file format. The *Hours Between Uploads* setting may range from 0.1 to 24.0 hours. Entering a setting of 0.0 hours disables FTP transfer and return the word DISABLED in the setting box. The file provides a snapshot of system performance data at the time the file is sent. There are two methods that file names uploaded to the server can be handled. The default of setting of *Increment File Name* will cause each file uploaded to have a different name of **FtpData#.csv** where # is incremented by one each FTP upload. In this case all uploaded files typically remain on the server until deleted by the user. If this option is selected # will start at 0 at UCM boot, reach a maximum count of 65,535, and then repeat. The other setting of *Use Same File Name* will cause each file uploaded to the server to be the same name of **FtpData.csv**. In this case, each uploaded file overwrites the previous file. Note that if the *Use Same File Name* option is selected # (from *Increment File Name*) continues to increment in the background with each file upload but is not appended to the file name.

**FTP COMMUNICATION SETTINGS**

The following setup information needs to be entered into the *FTP Data File Transfer* section of the *UCM Setup* web page for FTP file transfer. If necessary, contact your IT administrator or FTP Server provider for the required information and how to download the files to your local computer. Blue Sky Energy does not provide FTP download software or endorse any particular FTP download software. There are a variety of programs that can facilitate FTP download, but a popular free program is FileZilla available at <http://filezilla-project.org>.

- Address of remote FTP server (e.g., www.myserver.com)
- User name to allow access to the remote FTP server
- Password to allow access to the remote FTP server
- Intervals between file uploads in hours; Range 0.0 — 24.0 hours (setting of 0.0 hours disables FTP transfers)
- Selection of automatic file name increments, or overwriting of the same file name



➤ For the UCM to transfer files via FTP the *Gateway IP Address* in the Ethernet communications window of the *UCM Setup* page must be set to the IP Address the UCM will use to access the external DNS Server. In router based systems this is typically the IP Address of the router used for router setup. Refer to the your router’s documentation.

**FTP FILE CONTENTS**

The .csv format FTP file as viewed in an Excel spreadsheet is organized into two rows and multiple columns. The first row is the data name, with the second row being the data values collected at the point in time the FTP file was sent. If a data value in a record is unavailable that cell will contain dashes (—). A partial FTP data file is shown in Excel below.

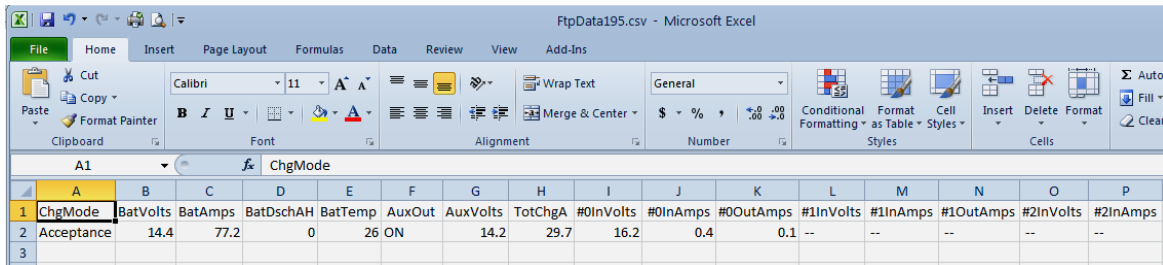

**FTP FILE DATA DESCRIPTIONS**

SPREADSHEET COLUMN	COLUMN HEADING	DESCRIPTION / COMMENTS
A	ChgMode	5 possible charge modes — <i>Off, Bulk, Absorption, Float or Equalize</i>
B	BatVolts	Battery voltage
C	BatAmps	Net battery current in amps, positive is charging — from IPN ProRemote
D	BatDschAH	Battery discharge amp-hours from full (negative) — from IPN ProRemote
E	BatTemp	Battery Temperature in °C, or <i>Bad or No Sensor</i> if faulty or not installed
F	AuxOut	State of the Auxiliary output, <i>ON</i> or <i>OFF</i>
G	AuxVolts	Auxiliary output voltage, operates in both <i>Aux. Battery Charge and Load Control</i> modes
H	TotChgA	Maximum total PV charge amps. Sum of all charge controllers on IPN network
I	#0InVolts	PV input voltage from Master charge controller — IPN address 0
J	#0InAmps	PV input amps from Master charge controller — IPN address 0
K	#0OutAmps	PV output amps from Master charge controller — IPN address 0
L	#1InVolts	Same charge controller voltage and current data as columns I, J & K above, but for charge controller Slave address #1. Additional data and columns to the right contain the same data for charge controller address #2 - #7.
M	#1InAmps	
N	#1OutAmps	

**TABLE 2**



**MODBUS**

As part of the UCM’s communication capabilities, the industry standard MODBUS application protocol is provided both as isolated RS-485 serial and as MODBUS/TCP (Transmission Control Protocol). MODBUS use described here assumes the user is familiar with the MODBUS protocol and its terminology. The UCM supports RTU mode only. Refer to [www.MODBUS.org](http://www.MODBUS.org) for more information.

**ELECTROSTATIC HANDLING PRECAUTIONS**

The UCM cover must be removed to configure DIP switch and jumper settings. With the cover removed observe industry standard electrostatic handling precautions to minimize the likelihood of electrostatic damage . At a minimum, discharge yourself by touching a water faucet or other electrical ground prior to handling the unit and avoid touching components on the circuit board. The risk of electrostatic damage is highest when relative humidity is below 40%.

**MODBUS OVER TCP**

The UCM communicates on port 502. The Slave Address / Unit Identifier only applies if MODBUS/TCP communication is converted back to RS-485 by an external user supplied TCP to RS-485 converter.

**SLAVE ADDRESS / UNIT IDENTIFIER**

DIP switches AD0 through AD7 as shown in Figure 4 set the UCM’s RS-485 RTU Slave Address / Unit Identifier within a selectable range of 1-247. Factory default Slave Address / Unit Identifier is 1 (AD0 - AD7 all OFF).



➤ RTU address DIP switches AD0 through AD7 are only read when the UCM boots and subsequent changes with power applied are ignored. **Note:** Booting the UCM with an address setting greater than 247 is not a valid address will restore all UCM software settings to As Shipped Factory Defaults.

Actual RTU address setting = **1 + Sum of DIP’s weighting code set to ON**

Examples: Address 1 = All Off , Address 5 = AD2 set to ON , Address 16 = AD0, 1, 2 & 3 set to ON

WEIGHTING CODE VALUE IF DIP = ON							
AD0	AD1	AD2	AD3	AD4	AD5	AD6	AD7
1	2	4	8	16	32	64	128

**ISOLATED RS-485**



➤ **WARNING:** The RS-485 serial port is electrically isolated from battery negative to eliminate ground loops. Do not exceed ±100V Peak difference between charge controller battery negative and MODBUS Master common. RS-485 terminal block COM connects to circuit common on the user side of the isolation barrier. Both sides of the isolation barrier are powered by the UCM.

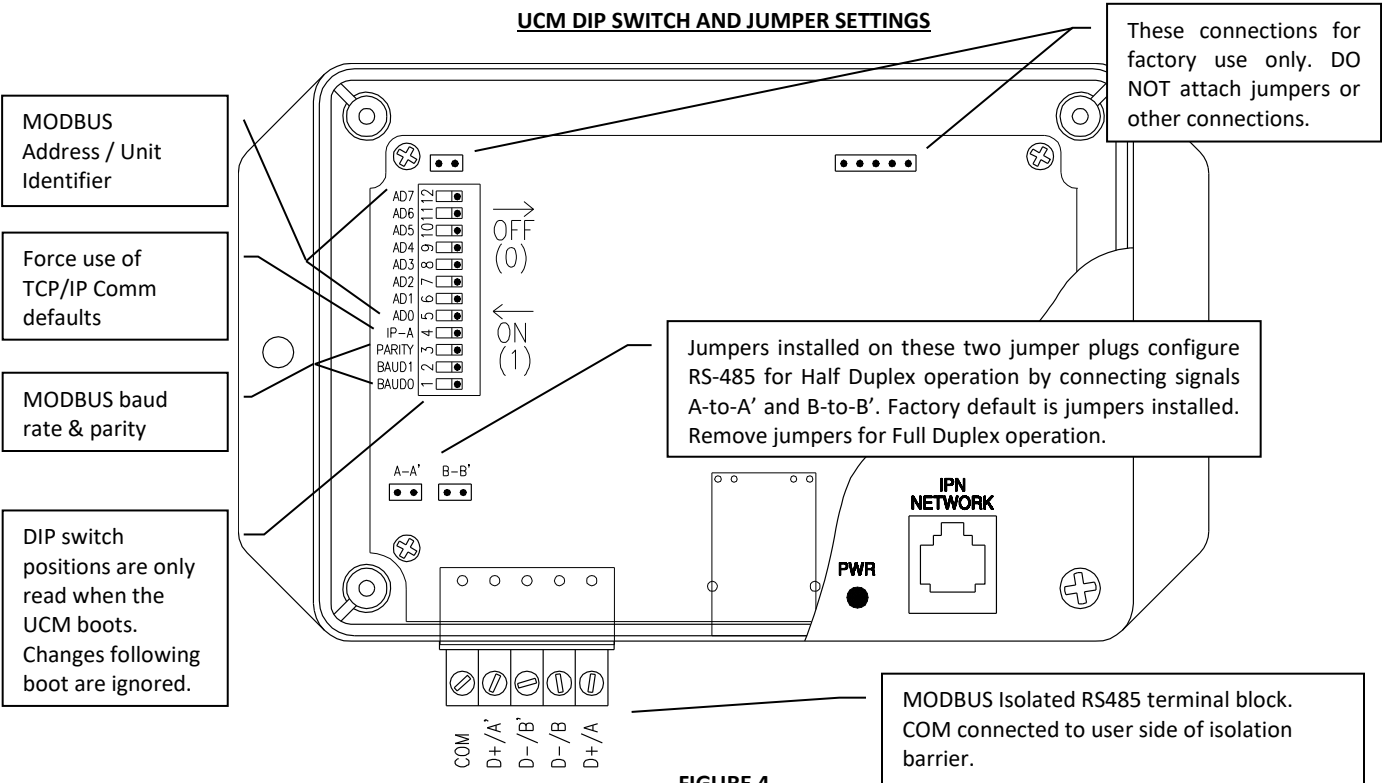

**FIGURE 4**

**RS-485 SERIAL COMMUNICATION SETTINGS**

Default RS-485 serial communication settings are half duplex, 19.2k baud, 8 data bits, Even Parity and 1 stop bit. To access internal DIP switch selectors and jumpers shown in Figure 4, remove the UCM cover.

**RS-485 BAUD RATE AND PARITY SELECT**

DIP SWITCH	FUNCTION	DESCRIPTION
BAUD0	Baud rate select	OFF = 19.2k baud, ON = 9600 baud
PARITY	Odd/Even Parity select	OFF = Even Parity, ON = Odd Parity
BAUD1	Parity Override	OFF = Parity per PARITY DIP switch, On = No Parity & 2 Stop Bits

**TABLE 3**

**Supported MODBUS Functions**

**1) Read Coils (0x01), Read Discrete Inputs (0x02)**

Query Packet:

Slave address | Function code 0x02 or 0x03 | MSB starting address | LSB address | MSB number of points | LSB number of points | LSB CRC | MSB CRC

Response Packet:

Slave address | Function code 0x02 or 0x03 | Number of data bytes always 1 | Bit packed status, LS bit status of addressed point | LSB CRC | MSB CRC

**READ COILS**

PDU ADDRESS	LOGICAL COIL #	DESCRIPTION
0x0000	1	Charge Efficiency Mode, 0 = Auto, 1 = Fixed
0x0001	2	Aux Out Mode, 0 = Volts, 1 = Amp-Hours
0x0002	3	Aux Out State, 0 = Off, 1 = On
0x0003	4	Temperature Sensor, 0 = Bad or missing

**TABLE 4**

**2a) Read Holding Registers (0x03), Read Input Registers (0x04)**

Query Packet:

Slave address | Function code = 0x03 or 0x04 | MSB starting register address | LSB address | MSB number of registers | LSB number of registers | LSB CRC | MSB CRC

Response Packet:

Slave address | Function code = 0x03 or 0x04 | number of data bytes | MSB of first register's contents | LSB of first register's contents | ... contents of more registers... | LSB CRC | MSB CRC

**2b) Preset Single Register (0x06)**

Used for changing all charge controller and IPN ProRemote setpoints.

Query Packet:

Slave Address | Function = 0x06 | MSB register address | LSB register address | MSB preset data | LSB preset data | LSB CRC | MSB CRC

Response Packet:

Slave Address | Function = 0x06 | MSB register address | LSB register address | MSB preset data | LSB preset data | LSB CRC | MSB CRC

## MODBUS REGISTERS

PDU ADDRESS	LOGICAL REGISTER #	FUNCTION CODES	DESCRIPTION	UNITS	SCALING
0x0000	1	3, 4	Charge State	Coded	0 = Off 1 = Absorption 2 = Float 3 = Equalize 4 = Bulk
0x0001	2	3, 4	Battery Volts	V	X10
0x0002	3	3, 4	Net Battery Amps, signed	A	X10
0x0003	4	3, 4	Sum of Input Amps from All Controllers	A	X10
0x0004	5	3, 4	Sum of Output Amps from All Controllers	A	X10
0x0005	6	3, 4	% Remaining Battery Capacity	%	None. Data valid following first switch to Float
0x0006	7	3, 4	Battery Amp-Hours from Full, sent unsigned	A	None. Data valid following first switch to Float
0x0007	8	3, 4	Aux. Battery Volts from Master, also functions in Load Control mode	V	X10
0x0008	9	3, 4	Remaining Equalize Time	Hours	X10
0x0009	10	3, 4	Days Since Last Full Charge	Days	none
0x000A	11	3, 4	Days Since Last Equalize	Days	none
0x000B	12	3, 4	Max. Battery Voltage Detected	V	X10
0x000C	13	3, 4	Min. Battery Voltage Detected	V	X10
0x000D	14	3, 4	Total Charge Amp-Hours	AH	none
0x000E	15	3, 4	Upper byte of Lifetime Amp-Hours	AH	none
0x000F	16	3, 4	Lower 16 bits of Lifetime Amp-Hours	AH	none
0x0010	17	3, 4	Battery Temperature	°C	Actual +60°C. (Range -60°C to +80°C)
0x0011	18	3, 4	Master: Heat Sink Temperature	°C	Actual +60°C
0x0012	19	3, 4	Master (Unit 0): Output Amps	A	X10
0x0013	20	3, 4	Master (Unit 0): Input Volts	V	X10
0x0014	21	3, 4	Master (Unit 0): Input Amps	A	X10
0x0015	22	3, 4	Unit 1: Heat Sink Temperature	°C	none
0x0016	23	3, 4	Unit 1: Output Amps	A	X10
0x0017	24	3, 4	Unit 1: Input Volts	V	X10
0x0018	25	3, 4	Unit 1: Input Amps	A	X10
0x0019	26	3, 4	Unit 2: Heat Sink Temperature	°C	none
0x001A	27	3, 4	Unit 2: Output Amps	A	X10
0x001B	28	3, 4	Unit 2: Input Volts	V	X10
0x001C	29	3, 4	Unit 2: Input Amps	A	X10
0x001D	30	3, 4	Unit 3: Heat Sink Temperature	°C	none
0x001E	31	3, 4	Unit 3: Output Amps	A	X10
0x001F	32	3, 4	Unit 3: Input Volts	V	X10
0x0020	33	3, 4	Unit 3: Input Amps	A	X10
0x0021	34	3, 4	Unit 4: Heat Sink Temperature	°C	none
0x0022	35	3, 4	Unit 4: Output Amps	A	X10
0x0023	36	3, 4	Unit 4: Input Volts	V	X10
0x0024	37	3, 4	Unit 4: Input Amps	A	X10
0x0025	38	3, 4	Unit 5: Heat Sink Temperature	°C	none
0x0026	39	3, 4	Unit 5: Output Amps	A	X10
0x0027	40	3, 4	Unit 5: Input Volts	V	X10
0x0028	41	3, 4	Unit 5: Input Amps	A	X10
0x0029	42	3, 4	Unit 6: Heat Sink Temperature	°C	none
0x002A	43	3, 4	Unit 6: Output Amps	A	X10
0x002B	44	3, 4	Unit 6: Input Volts	V	X10

PDU ADDRESS	LOGICAL REGISTER #	FUNCTION CODES	DESCRIPTION	UNITS	SCALING
0x002C	45	3, 4	Unit 6: Input Amps	A	X10
0x002D	46	3, 4	Unit 7: Heat Sink Temperature	°C	none
0x002E	47	3, 4	Unit 7: Output Amps	A	X10
0x002F	48	3, 4	Unit 7: Input Volts	V	X10
0x0030	49	3, 4	Unit 7: Input Amps	A	X10
0x0031	50	3, 4, 6	Rated Battery AH Set Point	Amp-Hours	none
0x0032	51	3, 4, 6	Charge Efficiency % Setpoint	%	none
0x0033	52	3, 4, 6	Self-Discharge % per month Setpoint	%	none
0x0034	53	3, 4, 6	Max. Battery Setpoint	V	X10
0x0035	54	3, 4, 6	<= Volts for Aux. Out Off Setpoint	V	X10
0x0036	55	3, 4, 6	>= Volts for Aux. Out On Setpoint	V	X10
0x0037	56	3, 4, 6	<= Amp-Hours for Aux. Out Off Setpoint	AH	none
0x0038	57	3, 4, 6	>= Amp-Hours for Aux. Out On Setpoint	AH	none
0x0039	58	3, 4, 6	Post Dusk Lights Setpoint	Hours	X10
0x003A	59	3, 4, 6	Pre-Dawn Lights Setpoint	Hours	X10
0x003B	60	3, 4, 6	Absorption Charge Voltage Setpoint	V	X10
0x003C	61	3, 4, 6	Float Charge Voltage Setpoint	V	X10
0x003D	62	3, 4, 6	Equalize Charge Voltage Setpoint	V	X10
0x003E	63	3, 4, 6	Equalize Hours Setpoint	Hours	X10
0x003F	64	3, 4, 6	Auto Equalize Days Setpoint	Day	none
0x0040	65	3, 4, 6	Temperature Compensation Factor	mV/°C/BatteryCell	X -100
0x0041	66	3, 4, 6	Float Transition Current Setpoint	Amps / 100 Amp-Hours	X10
0x0042	67	3, 4, 6	Absorption Hours Setpoint	Hours	X10

**TABLE 5**

**3) Force Single Coil (0x05)**

Query Packet:

Slave address | Function code 0x05 | MSB coil address | LSB coil address | MSB force data, don't care | LSB force data, don't care | LSB CRC | MSB CRC

Response Packet:

Slave address | Function code 0x05 | MSB coil address | LSB coil address | MSB force data, don't care | LSB force data, don't care | LSB CRC | MSB CRC

**FORCE COILS**

PDU ADDRESS	LOGICAL COIL #	DESCRIPTION
0x0013	20	Start Equalize
0x0014	21	Stop Equalize
0x0015	22	Clear Max. Battery Volts Detected
0x0016	23	Clear Min. Battery Volts Detected
0x0017	24	Clear Total Charge Amp-Hours
0x0018	25	Clear Lifetime Battery Discharge Amp-Hours
0x0019	26	Set Charge Efficiency to Auto Mode
0x001A	27	Set Charge Efficiency to Fixed Mode
0x001B	28	Set Aux. Out Mode to Volts
0x001C	29	Set Aux. Out Mode to Amp-Hours
0x001D	30	Restore Charge Controller Defaults

**TABLE 6**

**UCM SETUP PARAMETERS**



➤ The UCM has various setup parameters all of which are preconfigured at the factory. All settings are stored either in nonvolatile memory, DIP switches or jumpers such that all settings are retained following a loss of power.

***As Shipped Factory Default Settings***

Basic TCP/IP Communication

- IPv4 IP Address ..... 192.168.1.235
- Subnet Mask ..... 255.255.255.0
- Gateway IP Address ..... 192.168.1.1
- IP-A (force use of comm defaults) ..... off

Datalogging

- Hours in Log Period ..... Disabled

MODBUS

- Address / Unit Identifier ..... 1 (AD0 — AD7 all off)
- RS485 DataBits/Parity/StopBits ..... 8/Even/1 (Baud1/Parity off)

Misc.

- Location Name Reminder ..... MY SOLAR SYSTEM

FTP File Transfer

- Server address ..... —blank—
- User Name ..... —blank—
- Password ..... —blank—
- Hours Between Uploads ..... Disabled

UCM logon

- Password ..... admin

• RS-485 Duplex Mode ..... Half Duplex

• RS-495 Baud rate ..... 19.2K (baud0 off)

***Restoring As Shipped Factory Default Settings***

1. Remove UCM power
2. Set DIP's AD0 — AD7 shown in Figure 4 to all ON
3. Restore UCM power for 10 seconds, confirm power LED blinking
4. Remove UCM power
5. Set all 12 DIP's shown in Figure 4 to OFF
6. Install two jumper plugs A-to-A' and B-to-B' shown in Figure 4
7. UCM is now restored to As Shipped Factory Default Settings

**MOUNTING**



➤ **CAUTION:** This unit is not watertight and must be protected from rain, snow and excessive moisture.

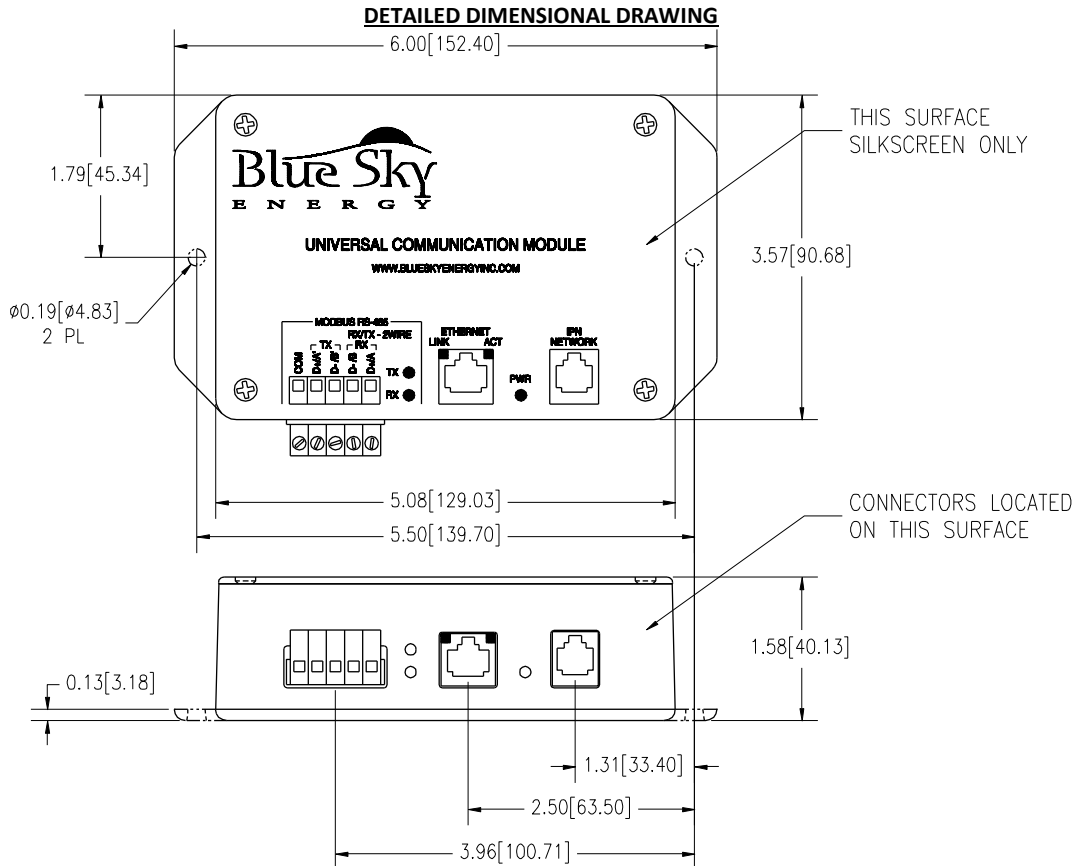

**FIGURE 5**

**TROUBLESHOOTING GUIDE**

SYMPTOM	PROBABLE CAUSE	ITEMS TO EXAMINE OR CORRECT
Power/Heartbeat LED off	No power	Charge controller not properly powered.  IPN Network cable faulty, not plugged in or cable pins do not swap per Figure 2.
Power/Heartbeat LED on solid and not blinking	UCM locked up due to EMI or voltage transient	Reboot UCM by momentarily removing IPN network cable or cycling charge controller power.
Unable to get to UCM web site login page via direct connection	Wrong cable type  Incorrect UCM communication settings  Incorrect TCP/IP settings in computer for direct connection	Crossover type cable required for direct connection communication.  Perform a Restore As Shipped Factory Defaults function in UCM.  Set computer TCP/IP settings as required for direct connection.
Unable to access UCM web site login page on LAN via router	LAN not operating properly  Incorrect UCM to router cable  Incorrect communication settings in UCM or router	Correct basic LAN operation.  Use standard patch cable from UCM to router, not Crossover cable supplied.  Correct communication settings in UCM and router per router documentation for router communication with UCM's fixed IP Address.  Refer to UCM Connection Using A Router section of manual.
Unable to access UCM over the Internet	UCM not accessible on LAN  Router not properly configured for Port Forwarding of UCM  ISP does not allow Port Forwarding  Not entering correct IP Address at remote computer    DNS Service (if used) not keeping track of routers IP Address	UCM must be accessible on LAN prior to attempting internet access.  Correct router's Port Forwarding settings per router documentation.  Get ISP to allow Port Forwarding or switch ISP's  Confirm you have the proper "router" WAN IP Address which is assigned by the ISP, refer to router documentation.  ISP may have changed the router's IP Address, consider using DNS service to keep track of IP Address changes  IP Address not entered into web browser in the proper form  Refer to DNS service provider documentation
UCM login page password not accepted	Password entered incorrectly or is unknown	Ensure password which is case sensitive is entered correctly  Perform a Restore As Shipped Factory Defaults function to restore password to <b>admin</b>
Commands or settings changes not received by charge control system	SET, CLEAR or START/STOP button not pressed.  Communication from UCM to charge controller not operating	Appropriate SET, CLEAR or START/STOP button must be pressed to send command or setting to charge controller.  IPN Network cable faulty
Certain data on UCM web page shown as dashes (---)	Device not present or information not available	Device (e.g., charge controller, IP -ProRemote) not present on IPN network or data not yet initialized. See device's documentation.
Settings changes off by factor of 10	Setting entered incorrectly	Decimal numbers such as 14.0 must be entered as 14.0 and not as 14.

SYMPTOM	PROBABLE CAUSE	ITEMS TO EXAMINE OR CORRECT
Certain UCM settings or commands do not operate properly	IPN ProRemote present with outdated pre V4.00 software	Update IPN ProRemote software to version V4.00 or later. Remove IPN ProRemote from system if software V4.00 or later not available.
MODBUS RS-485 not communicating	Incorrect duplex mode selected Incorrect A/B wiring polarity Incorrect communication settings	Correct Full Duplex / Half Duplex selection via jumpers. Correct A/B polarity Correct settings for Baud Rate, Parity & Stop Bits.
MODBUS TCP not communicating	Incorrect Port setting Incorrect IP Address Incorrect Function Code and/or Data	Set to Port 502. Use correct UCM IP Address Correct Function Code and/or Data

Specifications:	UCM
Power Consumption:	0.9W provided by charge controller
IPN Network:	RJ-11 Phone jack, 7' (2.1m) 4-wire swap cable
Ethernet:	Standard Ethernet TCP/IP 10Mbps, RJ-45 connector 3'(0.9m)
Modbus:	Standard Modbus RTU, slave address 1-247 via RS-485 or Modbus/IP
FTP Upload:	Up to 33 key performance parameters for up to 128 days. Datalog downloadable on Excel file
HTTP Web Site Driver:	Delivers HTTP web site for data view, parameter setup and data log file download to two locations simultaneously. Web site via router or LAN. Directly connection to PC via CAT5 crossover cable.
Datalogging:	Communication via 4-pin telephone cable length to 500' (152m). Current shunt via twisted pair cable length to 300' (91m)
	Datalog includes Min & Max bat voltage, Time in Accp & Float, Max bat discharge current, Min & Max bat AH from full, Max total PV output current, Total PV output AH. Plus for each individual controller; Max PV voltage, Max PV output current, and Total PV output Ah.
Operating Temperature:	-40°C – 50°C
Environmental Protection:	IP30
Weight:	0.39 lb. (178g)
Dimensions:	6.0 x 3.6 x 1.6" (15.2 x 9.1 x 4.0 cm)

As a part of our continuous improvement process specifications are subject to change without prior notice.  
With user supplied Internet connection. Requires IPN ProRemote with software version V4.00 or greater.

## **FIVE YEAR LIMITED WARRANTY**

Blue Sky Energy, Inc. (hereinafter BSE), hereby warrants to the original consumer purchaser, that the product or any part thereof shall be free from defects due to defective workmanship or materials for a period of five (5) years subject to the conditions set forth below.

1. This limited warranty is extended to the original consumer purchaser of the product, and is not extended to any other party.
2. The limited warranty period commences on the date the product is sold to the original consumer purchaser. For high volume OEM customers where it is not possible to match a product to a purchase date the limited warranty period commences on the manufacturing date of the product. A copy of the original purchase receipt identifying purchaser and date of purchase, must accompany the product to obtain warranty repairs.
3. This limited warranty does not apply to, and future warranty shall become void, for any product or part thereof damaged by; a) alteration, disassembly or application of a foreign substance, b) repair or service not rendered by a BSE authorized repair facility, c) accident or abuse, d) corrosion, e) lightning or other act of God, f) operation or installation contrary to instructions pertaining to the product, or g) cosmetic aging.
4. If BSE's examination of the product determines that the product is not defective the consumer shall be charged a test and evaluation fee of \$20 and be responsible for all transportation costs and insurance related to returning the product to the consumer. The consumer is ultimately responsible for proper installation and operation of the product and BSE's prior troubleshooting assistance shall not serve as a waiver of the test and evaluation fee. The test and evaluation fee is subject to change without prior notice.
5. If within the coverage of this limited warranty, BSE shall repair or replace the product at BSE's sole discretion and return the product via standard ground transportation of BSE's choosing within the continental US. The consumer shall be responsible for all transportation costs and insurance to return the product outside the continental US, and for all transportation costs and insurance related to expedited return of the product. BSE's liability for any defective product or any part thereof shall be limited to the repair or replacement of the product. BSE shall not be liable for any loss or damage to person or property, or any other damages, whether incidental, consequential or otherwise, caused by any defect in the product or any part thereof.
6. Any implied warranty for merchantability or fitness for a particular purpose is limited in duration to the length of this warranty.
7. To obtain warranty repairs, contact BSE at 760-597-1642 or techsupport@blueskyenergyinc.com to obtain a Returned Goods Authorization (RGA) number. Mark the outside of the package with the RGA number and return the product, postage prepaid and insured to the address below. The consumer is responsible for all transportation costs and insurance related to returning the product to BSE, and for any shipping damage which may void the warranty or increase the cost of repairs.