



**SA-1500 Series
Pure Sine Wave Inverter
User's Manual**



Contents

1.	Important Safety Instructions.....		
	1-1	General safety precautions.....	1
	1-2	Precautions when working with batteries.....	1
2.	Features.....		
	2-1	Application.....	2
	2-2	Electrical performance.....	3
	2-3	Rear panel operations.....	4
3.	Introduction.....		
	3-1	Front panel operations.....	5~7
	3-2	Rear panel operations.....	8~9
	3-3	Installation.....	9
	3-4	Quick hook - up and testing.....	10
	3-5	AC safety grounding.....	11~12
	3-6	Making DC wiring connections.....	13
	3-7	Inverter operation.....	14~15
	3-8	Power output.....	16
4.	Troubleshooting guide.....		17
5.	Maintenance		18
6.	Warranty		18
7.	Appendices A.....		
	7-1	Dip switch (110V).....	19
	7-2	Dip switch (220V).....	19
8.	Appendices B.....		
	8-1	Operations of RS232 serial port.....	20
	8-2	Interface command.....	21~25
9.	Appendices C.....		
	9-1	Remote control operations.....	26~27
	9-2	Power saving mode.....	28~31

1. Important Safety Instructions



WARNING!

Before using the Inverter, read and save the safety instructions.

1-1. General Safety Precautions

- 1-1-1. Do not expose the Inverter to rain, snow, spray, bilge or dust. To reduce risk of hazard, do not cover or obstruct the ventilation openings. Do not install the Inverter in a zero-clearance compartment. Overheating may result.
- 1-1-2. To avoid a risk of fire and electronic shock. Make sure that existing wiring is in good electrical condition; and that wire size is not undersized.
Do not operate the Inverter with damaged or substandard Wiring.
- 1-1-3. This equipment contains components which can produce arcs or sparks. To prevent fire or explosion do not install in compartments containing batteries or flammable materials or in locations which require ignition protected equipment. This includes any space containing gasoline-powered machinery, fuel tanks, or joints, fittings, or other connection between components of the fuel system.

1-2. Precautions When Working with Batteries

- 1-2-1. If battery acid contacts skin or clothing, wash immediately with soap and water. If acid enters eye, immediately flood eye with running cold water for at least 20 minutes and get medical attention immediately.
- 1-2-2. Never smoke or allow a spark or flame in vicinity of battery or Engine.
- 1-2-3. Do not drop a metal tool on the battery. The resulting spark or short-circuit on the battery or other electrical part may cause an explosion.
- 1-2-4. Remove personal metal items such as rings, bracelets, necklaces, and watches when working with a lead-acid battery,
A lead-acid battery produces a short-circuit current high enough to weld a ring or the like to metal, causing a severe burn.

2. Features

- Pure sine wave output (THD < 3%)
- Output frequency: 50 / 60Hz switch selectable
- Low power “Power Saving Mode” to conserve energy
- RS - 232C interface / remote controls port
- Built-in voltage and watt meter
- Thermostatically controlled cooling fan
- Advanced microprocessor
- Protection: Input low voltage Overload Short circuit
 Low battery alarm Input over voltage Over temperature

2-1. Application

- 2-1-1. Power tools - circular saws, drills, grinders, sanders, buffers, weed and hedge trimmers, air compressors.
- 2-1-2. Office equipment - computers, printers, monitors, facsimile machines, scanner.
- 2-1-3. Household items - vacuum cleaners, fans, fluorescent and incandescent lights, shavers, sewing machines.
- 2-1-4. Kitchen appliances - microwave ovens, refrigerators and freezers, coffee makers, blenders, ice markers, toasters.
- 2-1-5. Industrial equipment - metal halide lamp, high-pressure sodium lamp.
- 2-1-6. Home entertainment electronics - television, VCRs, video games, stereos, musical instruments, satellite equipment.

2-2. Electrical Performance

Specification	Model No.	
Item	SA-1500-112	SA-1500-124
Continuous Output Power	1500W	
Surge Rating	2000W	
Input Voltage	12V	24V
Output Voltage	100 / 110 / 115 / 120V +/- 5%	
Frequency (Switch Selectable)	50 / 60Hz +/- 0.05%	
Peak Output Current	25A	
Efficiency (full load)	85%	87%
No Load Current Draw	≤1.5W Saving Mode	
Output Waveform	Sine Wave <3% THD	
Output Voltage Regulation	100 / 110 / 115 / 120V RMS -10% / +4%	
Input Voltage Regulation	10-16 VDC	20-32 VDC
Protection	Overload, Short Circuit, Reverse Polarity (Fuse), Over/Under Input Voltage, Over Temperature.	
Power Saving Recovery Time	5 Second	
Interface Control Port	RS-232C With Baud Rate 1200,2400,4800 (Switch Selectable)	
Remote Control Unit	S-R5 Optional	
Safety	UL458	
EMC	FCC Class B	
Operating Temperature Range	0 - 40°C	
Storage Temperature Range	-30°C to 70°C	
Dimensions	390 (L) x 275 (W) x 105 (H) mm / 15.4 (L) x 10.8 (W) x 4.1 (H) Inch	
Cooling	Thermostatically controlled cooling fan (55°C ON , 45°C OFF)	
Weight	7.0 kg / 15.5 lbs.	

Note: The specifications are subject to change without notice.

2-3. Mechanical Drawings

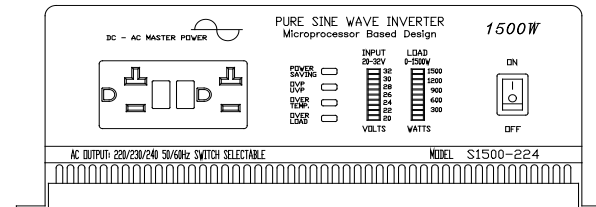
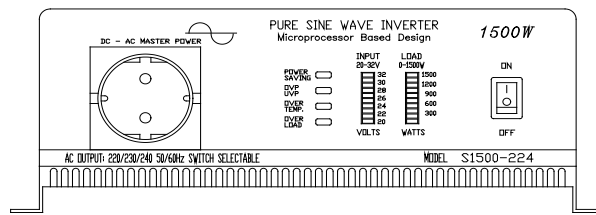
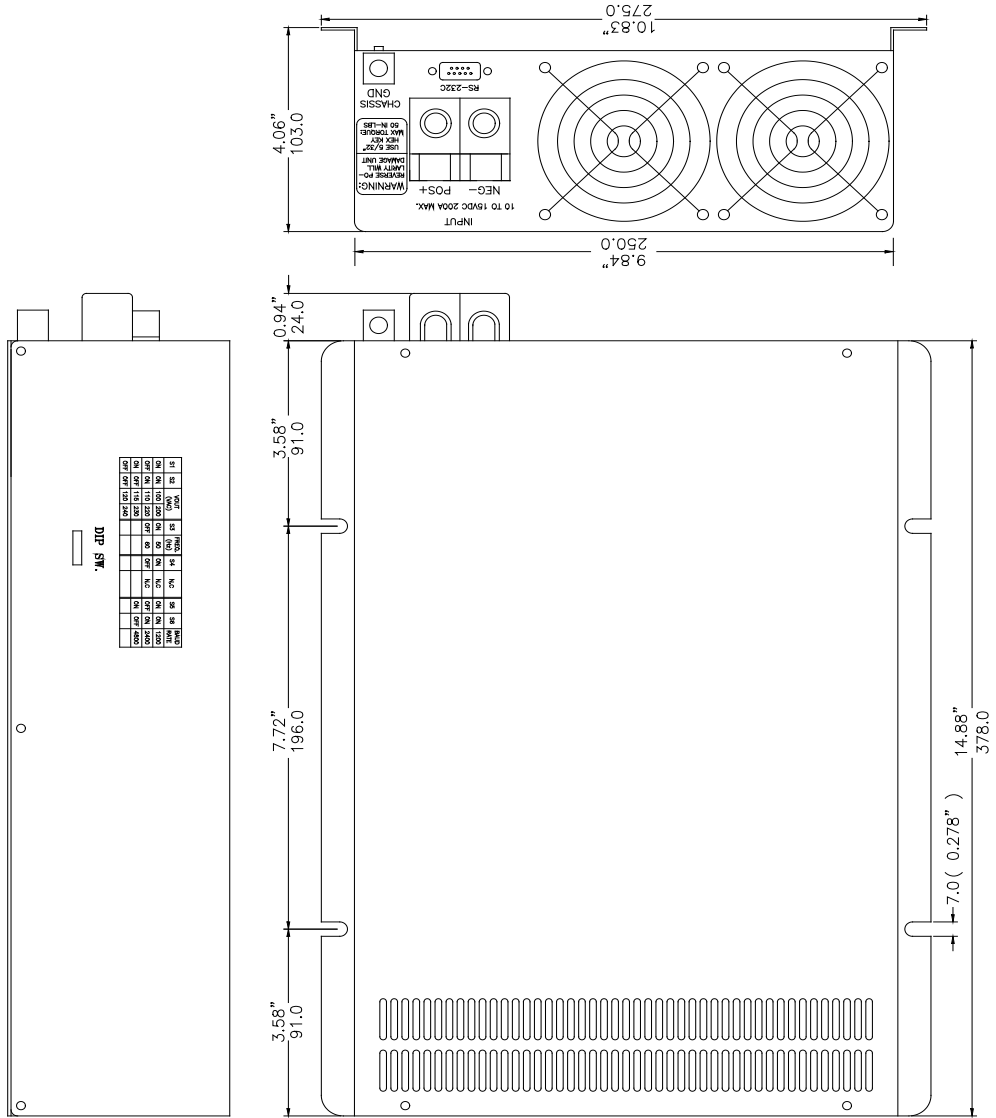

3. Introduction

This power inverter series is the member of the most advanced line of mobile AC power systems available.

To get the most out of the power inverter, it must be installed and used properly. Please read the instructions in this manual before installing and using this model.

3-1. Front Panel Operations

3-1-1. Front view

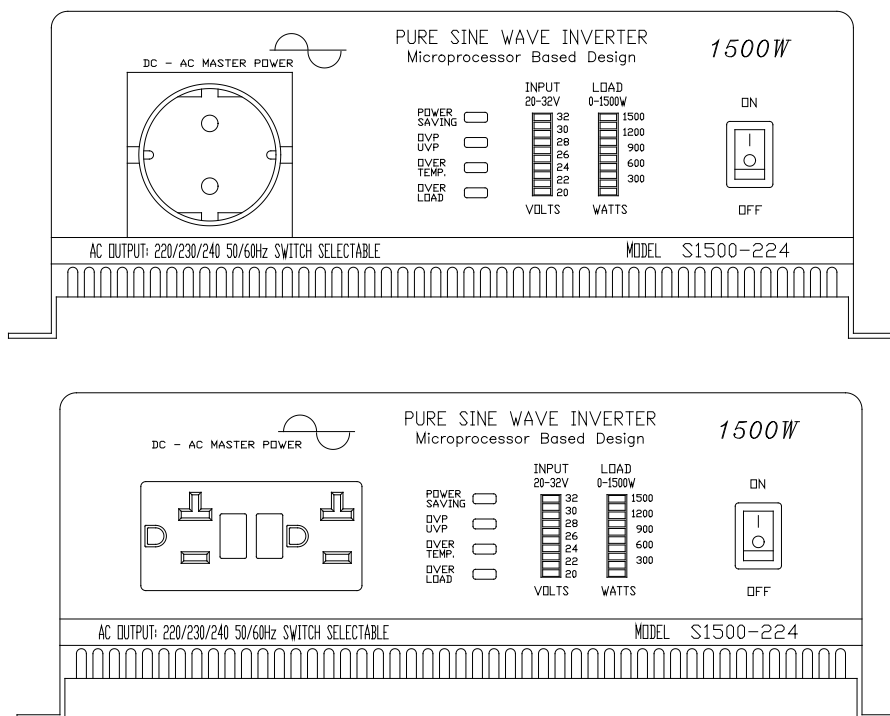

3-1-2. ON / OFF switch

Power ON/OFF switch, leave in the OFF position during installation.

3-1-3. Battery Voltage indicator

The battery voltage bar graph indicates the voltage at the input terminals of the power inverter. At low input current, this voltage is very close to the battery voltage. At high input current, this voltage will be lower than the battery voltage because of the voltage drop across the cable and connections. Ideally, the voltage should remain in the green Area of the bar graph. If the voltage goes into the red area at top and bottom of the graph, inverter may shutdown.

3-1-4. Battery Voltage indicator

The AC load watt bar graph indicates the power drawn from the power inverter by the load. For long term operation, the watt indicator should remain in the green & orange area of the bar graph. Short term operation is possible with watt indicator in the red area. If the watt indicator rises to high values the bar will flash and the inverter will shutdown to protect itself.

3-1-5. OVP : Over Voltage indicator

The over voltage indicator indicates that the power inverter has shut itself down because its input voltage exceeded 12 / 24 VDC version.

3-1-6. UVP : Under Voltage Protection indicator

The under voltage indicator indicates that the power inverter has shut itself down because its input voltage fell below 12 / 24 VDC.

3-1-7. OTP : Over Temperature Protection indicator

The over temp indicator indicates that the power inverter has shut itself down because its temp has become overheated. The power inverter may overheat because it has been operated at power levels above its rating, or because it has been installed in a location which does not allow it to dissipate heat properly. The power inverter will restart automatically, once it has cooled off.

3-1-8. OLP : Over Load Protection indicator

The overload indicator indicates that the power inverter has shut itself down because its output has been short circuited or drastically overloaded.

Switch the ON/OFF switch to OFF, correct the fault condition, and then switch the ON/OFF switch back to ON to reset the unit.

3-1-9. Power Saving: Power energy saving enable.

See appendix 9-2 for detailed information.

3-1-10. AC Outlet (Outlet sockets available):

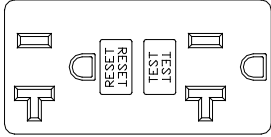
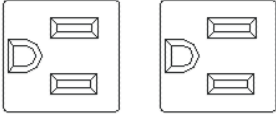
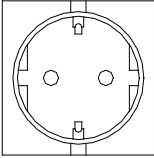
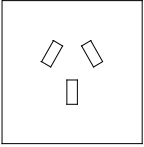
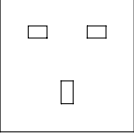
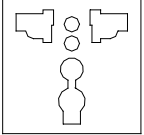
<p align="center">North America (GFCI)</p>	<p align="center">North America (NEMA 5-15R)</p>
	
<p align="center">Continental European (SCHUKO)</p>	<p align="center">Australia / New Zealand</p>
	
<p align="center">United Kingdom</p>	<p align="center">Universal</p>
	

3-2. Rear Panel Operations

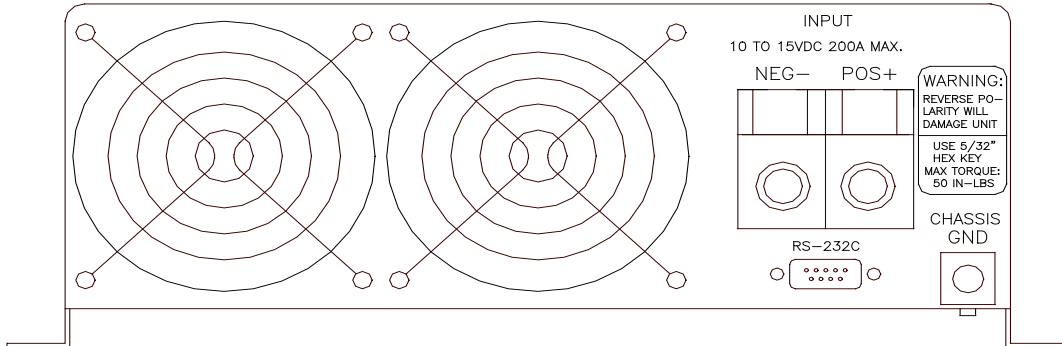

3-2-1. Ventilation Openings

Do not obstruct, allow at least 3 inch for air flow.

3-2-2. DC Terminals

Connect to 12V / 24 V battery or the other power sources.

【+】 is positive, **【-】** is negative. Reverse polarity connection will blow internal fuse and may damage inverter permanently.

Model voltage	Min voltage	Max. voltage
SA-1500-112	10.0 VDC	16.0 VDC
SA-1500-124	20.0 VDC	32.0 VDC



WARNING!

Do not connect the 12V model to a 24 battery, The unit will be destroyed immediately.

3-2-3. RS-232C

Connect to remote control unit (option accessory) or taken remote controlled working status by computer.

3-2-4. Connect chassis ground terminal to earth or to vehicle chassis using #8 AWG wire.



WARNING!

Operation of the inverter without a proper ground connection may result in an electrical safety hazard.

3-3. Protection Feature

Model	DC Input					Over Temperature Protection	
	Over voltage		Under Voltage Alarm	Under Voltage		Shut-down	Restart
	Shut-down	Restart		Shut-down	Restart		
SA-1500-112	17.1VDC	15.8VDC	10.2VDC	9.5VDC	12.4VDC	85°C	45°C
SA-1500-124	34.1VDC	31.5VDC	20.4VDC	19.3VDC	24.8VDC		

3-4. Installation

Where to install. The power inverter should be installed in a location that meets the following requirements:

- 3-4-1. Dry - Do not allow water to drip or splash on the inverter.
- 3-4-2. Cool - Ambient air temperature should be between 0°C
- 3-4-3. Safe - Do not install in a battery compartment or other areas where flammable fumes may exist, such as fuel storage areas or engine compartments.
- 3-4-4. Ventilated - Allow at least three inch of clearance around the inverter for air flow. Ensure the ventilation openings on the rear and front of the unit are not obstructed.
- 3-4-5. Dust-free - Do not install the Inverter in a dusty environments where are dust, wood particles or other filings/shavings. These dust can be pulled into the unit when the cooling fan is operating.
- 3-4-6. Close to batteries - Avoid excessive cable lengths but do not install the Inverter in the same compartment as batteries. Use the recommended wire lengths and sizes (see section 2-10). Also do not mount the Inverter where it will be exposed to the gases produced by the battery. These gases are very corrosive and prolonged exposure will damage the Inverter.



WARNING!

You may observe a spark when you make this connection since current may flow to charge capacitors in the power inverter. Do not make this connection in the presence of Flammable fumes. Explosion or fire may result.

3-5. Making DC Wiring Connections

Follow this procedure to connect the battery cables to the DC input terminals of the Inverter. Your cables should be as short as possible (ideally, less than 6 feet / 1.8 meters) enough to handle the required current in accordance with the electrical codes or regulations application. Cables are not an adequate gauge (too narrow) or too long will decrease the inverter performances such as poor surge capability and low input voltage warnings frequently and shutdowns. UVP warning presents due to DC voltage drop across the cables from the inverter to the batteries.

The longer or narrower the cables, the greater the voltage drop. Increasing your DC cable size will help improve the situation.

Model No	Wire AWG	Inline Fuse
SA-1500-112	# 2	200A
SA-1500-124	# 4	130A



WARNING!

The installation of a fuse must be on positive cable. Failure to place a fuse on “+” cables running between the inverter and battery may cause damage to the inverter and will void warranty.

Also, use only high quality copper wiring and keep cable length short, a maximum of 3-6 feet.

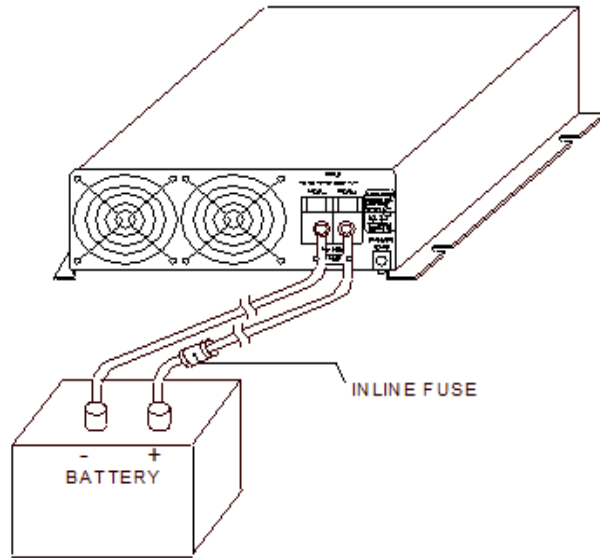

3-6. AC Safety Grounding

During the AC wiring installation, AC input and output ground wires are connected to the inverter. The AC input ground wire must connect to the incoming ground from your AC utility source.

The AC output ground wire should go to the grounding point for your loads (for example, a distribution panel ground bus).

Ground Fault Circuit Interrupters (GFCI)

Installations in Recreational Vehicles (for North American approvals) will require GFCI protection of all branch circuit connected to the AC output of the hardwire terminal equipped Inverter. In addition, electrical codes require GFCI protection of certain receptacles in residential installations.

While the pure sine wave output of the Inverter is equivalent to the wave form provided by utilities, compliance with UL standards requires us to test and recommend specific GFCI.

Samlex has tested the following GFCI - protected 20A receptacles and found that they functioned properly when connected to the output of the Inverter.

3-6-1. Neutral Grounding (GFCI'S)

3-6-1-1. **120V models.** The neutral conductor of the AC output circuit of the Inverter is automatically connected to the safety ground during inverter operation. This conforms to national electrical code requirements that separately derived AC sources (such as inverter and generators) have their neutral conductors tied to ground in the same way that the neutral conductor from the utility is tied to ground at the AC breaker panel. For models configured with a transfer relay, while AC utility power is presenting and the Inverter is in bypass mode, this connection (neutral of the Inverter's AC output to input safety ground) is not present so that the utility neutral is only connected to ground at your breaker panel, as required.

3-7. Inverter Operation

To operate the power inverter, turn it on by using the ON/OFF switch on the front panel. The power inverter is now ready to deliver AC power to your loads. If you are operating several loads from the power inverter, turn them on separately after the inverter has been turned on.

This will ensure that the power inverter does not have to deliver the starting currents for all the loads at once.

3-7-1. Unpack and inspect the power inverter, check to see that the power switch in the OFF position.

3-7-2. Connect the cables to the power input terminals on the rear panel of power inverter.

The terminal is positive (+) and black terminal is negative (-).

Insert the cables into the terminals and tighten allen nut to clamp the wires securely.



WARNING!

Make sure all the DC connections are tight (torque to 9-10 ft-lbs, 11.7-13Nm). Loose connections will overheat and could result in a potential hazard.

3-7-3. Before proceeding further, carefully check that cable you have just connected does tie negative terminal of inverter to the negative output power source.



WARNING!

Reverse polarity connection will blow a fuse in inverter and may permanently damage the inverter.

Damage caused by reverse polarity connection is not covered by warranty.

3-7-4. Connect the cable from the negative terminal of the inverter to the negative terminal of the power source. Make a secure connection.



WARNING!

You may observe a spark when you make this connection since current may flow to charge capacitors in the power inverter.

Do not make this connection in the presence of flammable fumes. Explosion or fire may result.

- 3-7-5. Set the power switch to the ON position. Check the meters and indicators on the front panel of the inverter. The voltage bar graph should indicate 11 to 14 volts (22 to 28V when 24V version is used) depending on the voltage of the power source. If does not, check your power source and the connections to inverter. The other indicators should be off.
- 3-7-6. Set power inverter switch to the OFF position, the indicator lights may blink and the internal alarm may sound momentarily. This is normal. Plug the test load into the AC receptacle on the front panel of the inverter. Leave the test load switch off.
- 3-7-7. Set power inverter switch to the ON position and turn the test load On. The inverter should supply power to the load. If you plan to accurately measure the true output r.m.s. voltage of inverter, a meter such as FLUKE 45 BECKMAN 4410 or TRIPLETT 200 must be used.

3-8. Power output:

The inverter will operate most AC loads within its power rating.

When deeming whether a microwave oven can be operated by the inverter, remember that the power commonly advertised for microwave ovens are the cooking power (the power delivered to the food) not the power actually consumed by the microwave oven. The microwave oven will consume 40% to 100% more than its advertised cooking power. Check the rating sticker on the back of the oven to determine its actual power requirements.

The 1500W inverter will operate small microwave oven (0.2 to 0.3 cubic foot capacity) that draws about 1700 watts. It will provide 3 minutes of cooking time. Some induction motors used in refrigerators, freezers, pumps, and other motor operated equipment require very high surge currents to start.

The Power Inverter may not be able to start some of these motor even though their rated current requirement is within the power inverter.

If motor is refused to start, observe the battery voltage indicator while trying to start the motor. If the battery voltage indicator drops below 11 volts while inverter is attempting to start the motor, this may be why the motor won't start. Make sure that the battery connections are good and the battery is fully charged.

4. Troubleshooting guide



WARNING!

Do not open or disassemble the Inverter.
 Attempting to service the unit yourself may result in a risk of electrical shock or fire.

Problems and Symptoms	Possible Cause	Solutions
Low output voltage	Using average reading voltmeter	Use true RMS reading meter and cable. See page 15 Point 3-7-7. of manual
Load LED bar flash	Overload	Reduce load.
No output voltage And voltage indicator in lower red zone	Low input voltage	Recharge battery, check connections and cable.
No output voltage Over Temp indicator on, load less than 1500W.	Thermal shutdown	Improve ventilation, Make sure ventilation openings in inverter are not obstructed. Reduce ambient temperature.
No output voltage, Over Load indicator On	Short circuit or Wiring error	Check AC wiring for short circuit or improper polarity (hot and neutral reversed).
	Very high power load	Remove load

5. Maintenance

Very little maintenance is required to keep your inverter operating properly. You should clean the exterior of the unit periodically with a damp cloth to prevent accumulation of dust and dirt. At the same time, tighten the screws on the DC input terminals.

6. Warranty

We warrant this product against defects in materials and workmanship for a period of 24 months from the date of purchase and will repair or replace any defective Power Inverter when directly returned, postage paid, to us.

This warranty will be considered void if the unit has suffered any obvious physical damage or alteration either internally or externally and does not cover damage arising from improper use such as plugging.

The unit into an unsuitable power sources attempts to operate products with excessive power consumption requirements, or use in unsuitable environments.

This is the only warranty that Samlex America Inc. makes.

No other warranties express or imply including warranties of merchantability and fitness for a particular purpose.

Repair and replacement are your sole remedies and Samlex America Inc. shall not be liable for damages, whether direct, incidental, special or consequential, even though caused by negligence or other fault.

7. Appendix A

7-1. Dip Switch (110V)

S1	S2	VOUT (VAC)	S3	FREQ. (Hz)	S5	S6	BAUD RATE
ON	ON	100	ON	50	ON	ON	1200
OFF	ON	110	OF	60	OFF	ON	2400
ON	OFF	115	-----	-----	ON	OFF	4800
OFF	OFF	120	-----	-----	OFF	OFF	4800

※S4 is unavailable

8. Appendix B

8-1. Operations of RS232 Serial Port

8-1-1. Hardware design :

This unit uses a 9-pin D connector and three of RS232 signal lines :

RECEIVE DATA (RXD) : PIN2

TRANSMIT DATA (TXD) : PIN3

DATA TERMINAL READY (DTR) : PIN4

8-1-2. The connection between this unit and a computer is as follows :

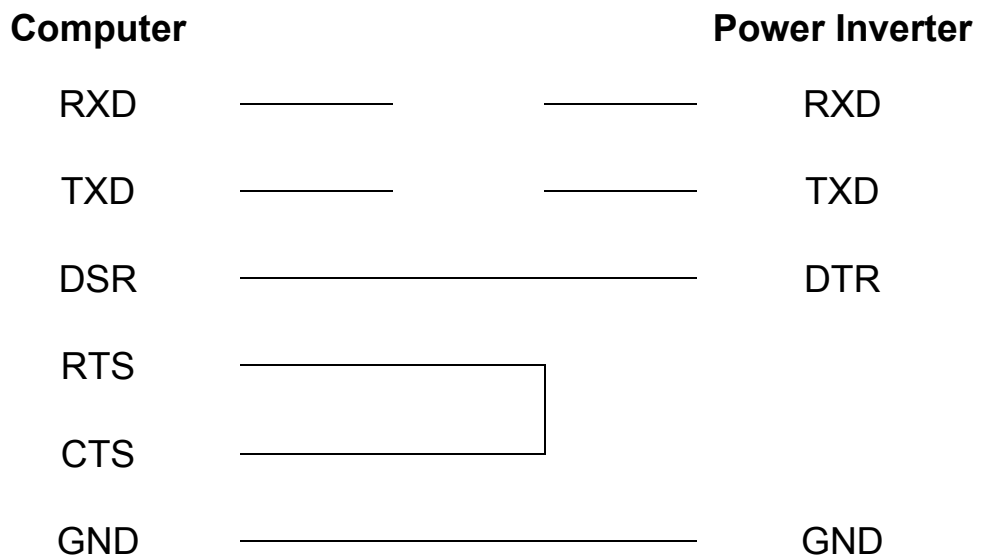

8-1-3. The RS232 interface of this unit employs ASCII code to implement the asynchronous serial transmission control.

The byte structure is START BIP – 8 BIT DATA-STOP BIT Baud rate : 1200,2400,4800,(SET BY DIP-SW).

Parity check : NONE, not settable

Data bit : 8, not settable.

Stop bit : 1, not settable.

8-2. Interface Command :

The buffer size used for the RS232 port is 12-bytes. This unit will ignore all bytes more than this value.

During transmission, this unit (inverter) will indicate it is ready to receive data from computer by the DTR line. A computer has to check the DTR line before sending any information to this unit.

This unit is normally always ready to receive data while operating.

When a LF character (ASCII code 0AH) is received, this unit would finish the receiving by clearing the DTR status and begin to interpret the received information. The unit would execute the received command (AND/OR data) if it is correct.

Irrespective of whether the command is accepted or not, the unit will always send back a response signal to the computer and set DTR to ready for receiving more incoming information.

8-2-1. The Baud Rate of the RS232 interface is determined by S5 and S6 of DIP-SW, as shows in Appendix A.

Note : You have to reset the unit after adjustment to activate the New settings.

8-2-2. Illustration of the RS232 operation :

8-2-2-1. RS232 command

Command format :

This unit uses high-level language commands with a CR (0DH) and a LF (0AH) as the end of the command.

The system would interpret and execute the command only after these two characters are received.

After the unit execute the command, it would send a response string to the computer.

The response string is as follows :

= > CR LF : Command executed successfully

? > CR LF : Command error, not accepted

! > CR LF : Command correct but execution error (e.g. parameters out of range)

If the command needs any information from the unit, the unit would send the information back to the computer (with CR and LF) and then send the response string to the computer.

8-2-2-2. Command format

This unit supports the following commands.

There should always be a CR (0DH) and a LF (0AH) appended to the command while sending the command to his unit.

8-2-2-3. PWRS command :

Power saving function control

Format : PWRS < value>

Illustration : A space (ASCII code 20H) is needed between
PWRS and < value >

< value > can be one of the following

“0” : Power saving disable

“1” : Power saving enable

“2” : Inquire the status of saving the response information
would be either “0” (disable) or “1” (enable)

8-2-2-4. Power command

Power ON/OFF control

Format : Power < value>

Illustration : A space (ASCII code 20H) is needed between
PWRS and < value >

< value > can be one of the following

“0” : Power off, power consumption < 2W, restart time < 5 sec

“1” : Power off, power consumption <20W, restart time < 2
sec

“2” : Power on

“3” : Inquire the status of power on/off status, the response
information would be either “0” (OFF) or “1” (OFF) or “2”
(ON)

8-2-2-5. To query status command

Format : STUS?

Illustration : Don't need to add any of parameter.

To respond the result be hexadecimal code replaced by 2 ASCII codes that is between 00 ~ FF (0~255), then convert the Hex code to the binary digit after obtaining 8 bytes digit that can be one of following :

“B0” UVP (LSB)

“B1” OVP

“B2” OLP (Loading > 110%)

“B3” FLP (Loading > 100% / 3min)

“B4” OTP

“B5” BATT Too Low

“B6” BATT Too High

“B7” BATT Too High (MSB)

8-2-2-6. To query battery level command

Format : BATT?

Illustration : Don't need to add any of parameter.

To respond the result be Hexadecimal code replaced by 2 ASCII codes and is between 00 ~ 0B, then convert into decade digit after obtaining a digit, between 0 ~ 11, that can be one of following :

Hex code	Decade code	Indication
00	0	LED 1 glows blinking to indicate low voltage
01	1	LED 1 glows solid.
02	2	LED 2 glows solid.
03	3	LED 3 glows solid.
04	4	LED 4 glows solid.
05	5	LED 5 glows solid.
06	6	LED 6 glows solid.
07	7	LED 7 glows solid.
08	8	LED 8 glows solid.
09	9	LED 9 glows solid.
0A	10	LED 10 glows solid.
0B	11	LED 10 glows blinking to indicate over voltage

8-2-2-7. To query load level command :

Format : Load?

Illustration : Don't need adding any of parameter.

Respond : The same as BATT?

< value > can be one of following

Hex code	Decade code	Indication
00	0	Load < 5%, All of LED indicators go "OFF"
01	1	Load < 15%, LED 1 indicator glows.
02	2	Load < 25%, LED 1~LED 2 indicators glow.
03	3	Load < 35%, LED 1~LED 3 indicators glow.
04	4	Load < 45%, LED 1~LED 4 indicators glow.
05	5	Load < 55%, LED 1~LED 5 indicators glow.
06	6	Load < 65%, LED 1~LED 6 indicators glow.
07	7	Load < 75%, LED 1~LED 7 indicators glow.
08	8	Load < 85%, LED 1~LED 5 indicators glow.
09	9	Load < 95%, LED 1~LED 5 indicators glow.
0A	10	Load < 105%, LED 1~LED 10 indicators glow.
0B	11	Load > 105%, All of LED indicators glow blinking to indicate over load.

9. Appendix C

9-1. Remote Control Operations: (Optional accessory)

System Configuration:

9-1-1. Plug the 9-pin D-SUB connector of the remote controller in the RS-232 port of the Inverter.

9-1-2. Check the setting of DIP-SW S5 & S6, The communication BAUD RATE should be set to 4800bps (S5 & S6 OFF).

LED Indications:

9-1-3. Turn on the switch of the Inverter, There will be two short beep sounds from the Inverter. All LEDs will be ON and, one second later, there will be a short Beep sound. The amber, green and red LEDs of remote controller will be on for 0.5 second then off sequentially. The Inverter is then in the OFF mode.

The amber LED will be blinking every 2~3 seconds.

9-1-3-1. Remote Controller LEDs:

Color / Status	Power Saving	Power Output
Green "ON"	Enable	ON
Green "Blinking"	Enable	OFF
Amber "ON"	Enable	ON
Amber "Blinking"	Enable	OFF

Green : Power saving enable.1

Amber : Power saving disable.

On : Power On

Blinking : Power Off

Operations:

- 9-1-4. Set SLIDE SW "ON" (Keypads will not work if SLIDE SW is set "OFF")
- 9-1-5. Remote ON/OFF : Pressing a button (and releasing in one second) will change (toggle) the output ON/OFF mode and the display of LEDS will be changed accordingly.
- 9-1-6. Operations of power saving mode :
 - Press the button for 2 seconds and the colors of LED will be changed.
 - Keep pressing the button and the colors will be toggling between amber and green every 2~3 seconds.
 - The color of LED will determine the mode of operation.
 - Green indicates that power saving mode is enabled and amber indicates is disabled.
 - Release the button when the LED indicating the desired status is reached.
- 9-1-7. The operation power saving enable / disable does not change the power ON/OFF mode.
- 9-1-8. Despite the setting of power saving mode, when a power OFF command is set by pressing a button, the power will be turned OFF and the power saving mode will be set to disable automatically (amber LED will flash for 2~3 seconds). When the power is turned On, the power saving mode will restore the previous setting.

9-2. Power saving mode

MICROPROCESSOR BASED SINE WAVE INVERTER S-1500 SERIES ENABLING AND DISABLING POWER SAVING MODE

- 9-2-1. When an inverter is powered on and is running in idle condition (there is no load or the load connected to the inverter has been switched off), it will still draw some power from the batteries for keeping the system alive.
- 9-2-2. This inverter features a power saving “sleep” mode for conserving the battery power during idle conditions. When this mode is enabled, the inverter senses the output power being drawn and if this is less than 2 to 15 watts, the inverter shuts down the output power. Only essential systems are kept alive to reduce power consumption from the batteries to a very low value of only about 1.5 watts. As soon as a load is switched on, the inverter wakes up from its “sleep” condition and restores the output power after a response time of about 8 seconds. Please note that on waking up from the power saving “sleep” mode, the inverter requires some time to prepare all the systems before it can start delivering power to the load. Hence, the output power will not be available immediately but after a time lag of approx. 15 to 18 sec. If using a hand tool or other appliance with a trigger, keep the trigger pressed for some time till the power is available to drive the tool / appliance.
- 9-2-3. The power saving “sleep” mode can be enabled or disabled with the help of the power on / off switch or with the help of the optional remote control. Procedure to switch between the two states is given at para 6 below. The inverter has been factory pre-set in the enabled condition.
- 9-2-4. Power saving “sleep” mode, enabled
- 9-2-4-1. The front plate has a green led marked “power saving” for indication of enabled state of power saving “sleep” mode (here-in-after referred to as the green led)

9-2-4-2. The power saving “sleep” mode is enabled in either of the following indications (When inverter is in on condition):
The green led flashing sequence is:
Flash-flash-gap-flash-flash-gap... (power saving “sleep” mode, idle condition or no load) .
The green led is continuously lighted (power saving “sleep” mode, loaded).

9-2-5. Following indications will be observed when the inverter is powered on and subsequently loaded and unloaded when power saving “sleep” mode is in enabled condition: (the initial condition is that the inverter is switched off and all loads are disconnected).

9-2-5-1. Switch on the inverter. There will be 2 beeps and the green led will start flashing with a flashing sequence of flash-flash-flash... After about 3 seconds, there will be 1 beep, the green led will stop flashing and it will be lighted continuously. Output power will be available after about 15 to 18 sec from the time the green led stops flashing. After the output power is made available, the inverter searches if any load is connected. If the load is less than 2 to 15 watts, the output power is shut down after about 15 seconds from the time the output power is made available. The green led will start a flashing sequence of flash-flash-gap-flash-flash-gap... (this indicates that the inverter is in power saving “sleep” mode and is idling at no load).

9-2-5-2. If now a load more than 2 to 15 watts is switched on, the green led stops flashing after about 3 seconds and will be lighted continuously. After about 15 to 18 seconds after the green led has stopped flashing and become steady, output power will be available to the load. The green led will be lighted continuously (this indicates that the inverter is in power saving “sleep” mode and is in loaded condition).

9-2-5-3. If the load is switched off, the output power will be shut down after about 15 to 18 seconds and the green led will start flashing with a flashing sequence of flash-flash-gap-flash-flash-gap...(this indicates that the inverter is in power saving “sleep” mode and is idling at no load).

9-2-6. Power saving “sleep” mode, disabled

- 9-2-6-1. The front plate has a green led marked “power saving” for indication of enable state of power save “sleep” mode (here-in-after referred to as the green led).
- 9-2-6-2. The power saving “sleep” mode is disabled when the green led marked “power saving” is off. In this mode the output power is always available.
- 9-2-6-3. Following indications will be observed when the inverter is powered on and subsequently loaded and unloaded when power saving “sleep” mode is in disabled condition: (the initial condition is that the inverter is switched off and all loads are disconnected).
 - 9-2-6-3-1. Switch on the inverter. There will be 2 beeps and green led will start flashing with a flashing sequence of flash-flash-flash... After about 3 seconds, there will be 1 beep and the green led will stop flashing and switch off. Output power will be available after about 15 to 18 sec from the time the green led switches off. The output power will be always available, even in no load idling condition.
The green led will be off all the time.

9-2-7. Switching between enabled and disabled states of power saving “sleep” mode

- 9-2-7-1. Switching between enabled and disabled states of power saving “sleep” mode can be done with the help of the power on / off switch on the front plate of the inverter or with the help of the optional remote control.
Switch on the front plate of the inverter is done as follows:

Switch on the front plate of the inverter is done as follows:
This procedure acts as a toggle i.e. If the inverter was in enabled state before the procedure, it will switch to disabled state after the procedure.

Likewise, if it was in disabled state before the procedure, it will switch to enabled state after the procedure.

Switch off all the loads, switch off the inverter, disconnect all loads. Switch on the inverter. There will be 2 beeps and green led will start flashing with a flashing sequence of flash-flash-flash... (it will flash for approx. 3 seconds).

Immediately after it starts flashing, switch off the power on / off switch and immediately switch on again. This will complete the switching procedure. The inverter will continue its power on sequence and switch over to the new state.

The power on / off switch should be switched off and on again during the time the green led is flashing (the green led will flash with a sequence of flash-flash-flash... For about 3 seconds after the inverter is powered on).



Samlex America Inc.

110-17 Fawcett Road, Coquitlam, BC, V3K 6V2 Canada

Toll free phone: 1-800-561-5885

Toll free fax: 1-888-814-5210

General Inquiries: samlex@samlexamerica.com

WWW: <http://www.samlexamerica.com>