



# INSTALLATION GUIDE

## Guide for your AZ-225 Dual-Axis, Azimuth Drive Solar Tracker

***Congratulations***, you have purchased the finest solar tracker available. With proper installation, your tracker will provide years of trouble-free service while maximizing your solar power production.

Your tracker may include one of the following options: (Check your packing slip.):

- ◆ **Stainless Steel Hardware Option** - Recommended for high humidity and salt laden environments.
- ◆ **Wattsun Voltage Converter Option** - Required for PV Systems other than 24 VDC.
- ◆ **Manual Control Option** - Exterior switches so you may manually operate the tracker.

The tracker comes complete with all the hardware necessary for assembly and mounting the PV modules. The Wattsun™ Tracker requires a length of **Eight-Inch ID Schedule 40 Steel Pipe** for use as the pipe mast. Specifications for the pipe mast can be found on the data sheet for this particular tracker. **The steel mounting pipe and PV modules are not included. Your electrician should provide all additional array wiring, fusing, power disconnects, grounding equipment and electrical junction boxes.**

### WARNING:

If the Wattsun™ Azimuth Solar Tracker is not installed to manufacturer's specifications, such failure to properly install unit may cause tracker malfunction and or serious bodily injury or death. This tracker moves, therefore the tracker should be situated away from anybody or anything that may come in contact with it as it moves.

**KEEP CHILDREN AWAY FROM TRACKER AT ALL TIMES.**

Array Technologies, Inc.  
3312 Stanford NE  
Albuquerque, NM 87107

Tel: 505-881-7567  
Fax: 505-881-7572  
URL: [www.wattsun.com](http://www.wattsun.com)

**Copyright © Array Technologies, Inc.  
All rights reserved.**

**Wattsun™ is a trademark of Array Technologies, Inc.**



**Sixteen, BP 150 watt modules mounted on a Wattsun AZ-225 Tracker Drive.**

**AZ-225 Installation Guide: Revision 6  
Aug 2009**

## WARNING TO ELECTRICIAN OR INSTALLER

- ◆ **Please read this instruction manual completely.**
  - ◆ **If you are unfamiliar with NEC** compliant solar electric installation, then **consult with the dealer** that supplied your tracker. They should have the skill and expertise to supply you with the necessary wiring diagrams and the appropriate connection wire, grounding equipment, junction boxes and fusing.
  - ◆ **Failure to ground the array structure**, including each module frame, the aluminum tracker frame, the drive head assembly and the pipe mast may make the tracker susceptible to damage by lightning.
  - ◆ **Do not rely on the pipe mast to act as a ground rod.** It is not a reliable substitute for a properly installed ground rod.
  - ◆ **Please send in the Wattsun Tracker Warranty Card.** Array Technologies does not share any of the information provided on the warranty card.
- 

- ◆ **Please leave this manual for the tracker owner(s).** It is their property and will help resolve any potential problems.
- ◆ **Please provide the following information for the owner:**

Serial Numbers: \_\_\_\_\_  
Serial Number located on the controller      Serial Number located on the drive assembly

Tracker Type: Dual-Axis Tracker is Standard on AZ-225

Controller is powered from:  Battery Bank       Power Supply

System Type:  Off-Grid/Remote Home       Grid-Intertie - no battery backup       Grid-Intertie - battery backup  
 Water Pumping       Other \_\_\_\_\_

PV Array: PV System Voltage is \_\_\_\_\_ VDC      Number of Modules: \_\_\_\_\_

Module Manufacturer: \_\_\_\_\_      Module Model: \_\_\_\_\_

Mounting Pole Height above the Ground is: \_\_\_\_\_ FT

# TABLE OF CONTENTS

<b>SECTION</b>	<b>TITLE</b>	<b>PAGE</b>
1	Installation of the Tracker Pipe Mast and Foundation.	5
2	Orient the Azimuth Gear Drive Assembly	6
3	Install the Drive, Elevation Actuator & Torque Tube	8
4	Installing the Module Support Frame	11
5	Installing a Wattsun Solar Tracker Controller	18
6	Power Connection to the Elevation Actuator	24
7	Power Connection to the Tracker Controller	25
8	Setting Preferences and Operating the Tracker Controller	29
9	Setting the AZ Motor Limits	31
10	Manual Control Option	32
11	Periodic Maintenance	33
12	Suggested Methods for Grounding a Tracker	34
13	Array Technologies, Inc. Limited Warranty	38

**WARNING! WINDY CONDITIONS CAN EXERT EXTREME FORCES ON THE ARRAY, FOUNDATION, AND PIPE MAST OF YOUR TRACKER.**

- 1.1) Choose an optimum solar location to install the PV array for in the ground mounting. The location should be free from obstructions. Keep in mind that over a period of time, that trees, shrubs, etc. may grow enough to obscure the PV array from the sun. Consult with your dealer for proper tracker spacing and alignment regarding multiple tracker installations.
- 1.2) Dig an appropriate sized hole for your tracker's foundation using a shovel, auger, or backhoe. The variables that affect the design of the foundation include: tracker size, pipe mast height, soil conditions, geographical location, weather and local building codes. Employ a qualified professional to design the foundation for your tracker.
- 1.3) A general rule of thumb is to have an equal amount of pipe underground as above the ground and a three-foot diameter reinforced concrete foundation. Please have a professional design the size and type of foundation required!
- 1.4) Use the appropriate length of 8" ID, Schedule 40 Steel Pipe in order to leave the recommended maximum pipe mast height protruding from ground. Consult your specific Wattsun Technical Data Sheet for the appropriate mast height and pipe diameter size. Note: If the recommended pipe mast height is exceeded, it may be necessary to telescope a larger diameter pipe in the lower portion and increase the foundation size in order to withstand the increased forces exerted during windy conditions.
- 1.5) Cut at least two pieces of re-bar or steel angle (more with 8 module or larger trackers), at lengths equal to the full diameter of the foundation. Weld re-bar onto (or drill holes and insert re-bar into) the underground portion of the pipe so that the pieces of re-bar form an 'x' pattern that remains parallel to the ground. When the tracker pipe mast is completely installed, the re-bar will be perpendicular to the pipe and parallel to the ground and protrudes radially outward into the concrete foundation. The re-bar acts as an "anti-rotation" device and will keep the pipe from spinning in the hole if the concrete shrinks back from the pipe.
- 1.6) Set the pipe into the hole and pour concrete around the pipe until it completely fills the hole. Also pour concrete into the pipe to secure the re-bar inserted in the bottom portion of pipe. Make certain the pipe is vertically plumb and allow concrete to set for at least 24 hours. If you fill the entire pipe mast with concrete, leave at least one foot of hollow pipe at top for azimuth drive assembly clearance.

**SIMPLIFIED TRACKER FOUNDATION DIAGRAM**  
(Using recommended mast height from your Technical Data Sheet)

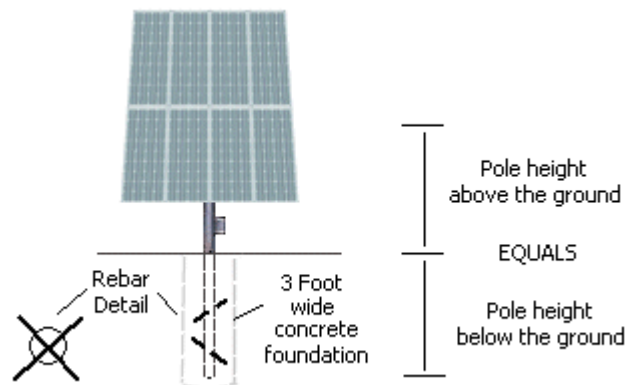

**Array Technologies, Inc. assumes no liability for your foundation installation. Please consult with a local professional or your Wattsun Solar Tracker Dealer.**

**2.1) Northern or Southern Hemisphere installations.**

**For Northern Hemisphere installations**, point the motor/gear assembly to 'true north' \* and tighten the four set bolts to secure tracker to pipe mast. The set bolts should be tightened so that they dig into the pipe mast.

**For Southern Hemisphere locations**, point the motor/gear assembly to 'true south' \* and tighten the four set bolts to secure tracker to pipe mast. The set bolts should be tightened so that they dig into the pipe mast.

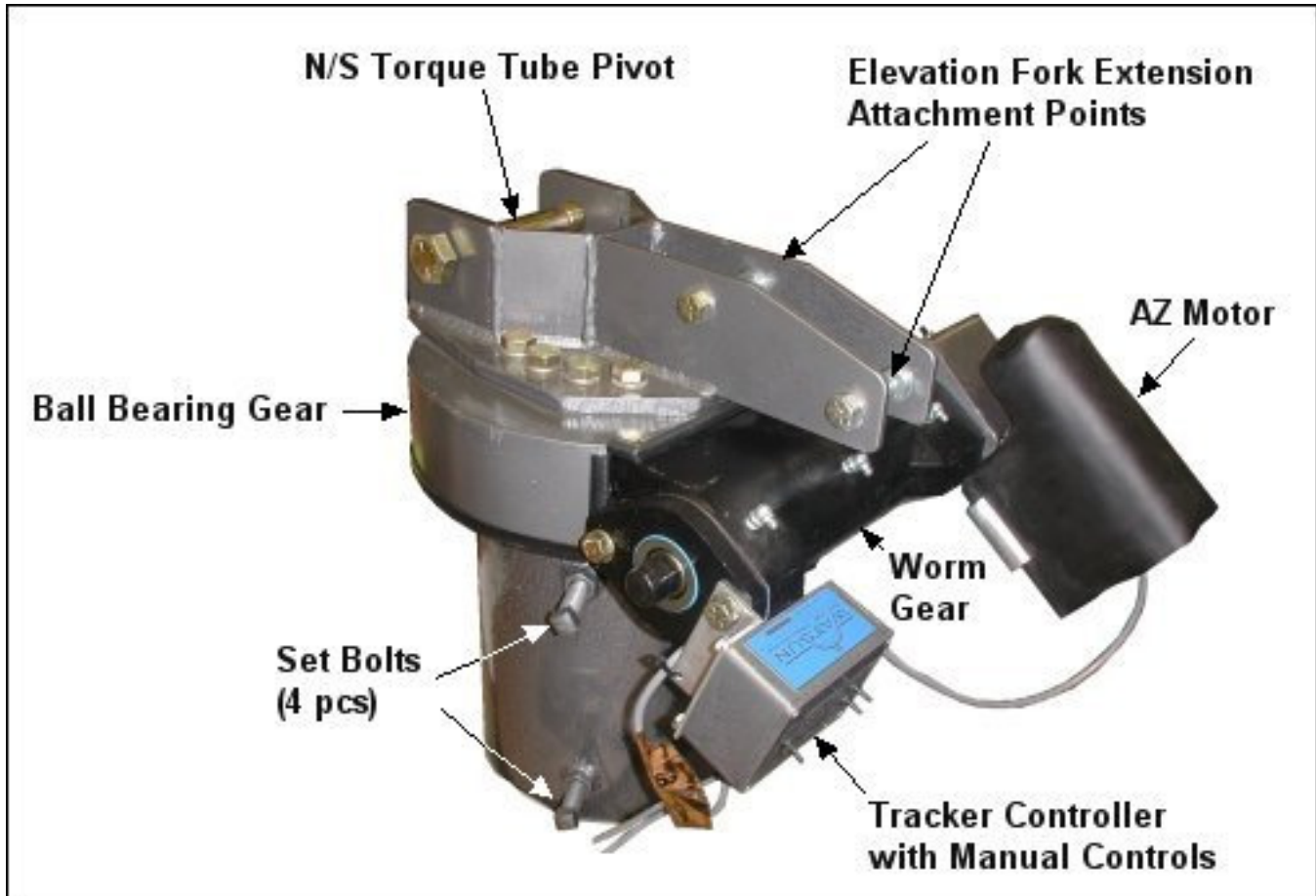

**Tropical and Equatorial Installations are discussed in Section 3.5**

**\* Note:**

True north and south differ from magnetic north and south and depends on geographical location. Locate 'magnetic north' or 'magnetic south' using a compass and adjust your tracker setting accordingly. Your Wattsun Tracker Dealer can provide you with the Magnetic Declination for your area. The Array Technologies web site ([www.wattsun.com](http://www.wattsun.com)) has links to geomagnetic data. You can find, or calculate, the magnetic declination for any place on the globe.

Perhaps the easiest way to find the North-South line is to get a copy of your local newspaper and find the Sunrise and Sunset times. Determine the time (hour and minute) that falls exactly halfway between Sunrise and Sunset. At the halfway or 'Solar Noon' point, anything that casts a shadow will do so along a North-South line. Get a friend to help hold up a length of wood or a stick of conduit straight up into the sky. Then stake out or mark the North-South shadow line.



## VERY IMPORTANT! "OUT OF THE BOX" DRIVE ORIENTATION

The AZ-225 Drive orientation is preset at the factory and referenced to Solar Noon. The drive should be mounted facing due South, (Due North in the Southern Hemisphere.). The four set bolts "dig in" to the mounting pipe and secure the drive to the pipe mast.

**SET BOLTS:** The 4 "cup point" set bolts "dig and cut" in to the 8" ID SCH40 Steel Pipe Mast. Tighten the set bolts so that they put strong and equal pressure on the pipe mast. Each bolt should "show" and equal amount of thread when you are finished. **Each set bolt should be tightened to 100 Ft-Lbs of torque.**

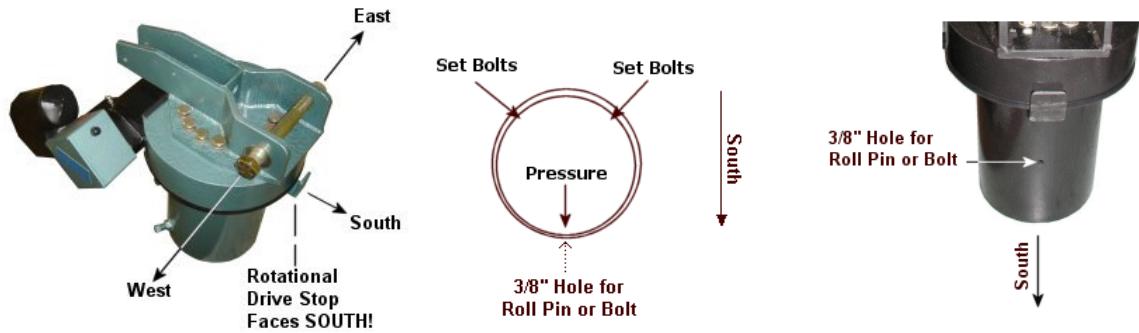

**ROLL PIN:** A three-eighths inch (3/8") diameter hole is predrilled in the midpoint of the south face of the drive. The hole accommodates the 3/8" roll pin. Once you are sure that the drive is facing due South, you can use the hole as a guide to drill a three-eighths inch (3/8") diameter hole into and through the wall of the mounting pipe. Then tap in the roll pin so that it penetrates through both the drive and pipe mast. Alternately, both holes could be threaded and a bolt could be used to "pin" the drive and mounting pipe together.



**J-BOX & OTHER EQUIPMENT ON THE MOUNTING POLE:** Any equipment that will be mounted on the pipe mast should be located on the North side (opposite of the roll pin hole), at least one foot down from the top of the pipe. That allows for our sleeve to fully seat on the pipe and that nothing physically interferes with the tracker range of motion.

## Section 3

# Install the Elevation Actuator & Torque Tube

*(Most trackers are shipped from the factory with the lower fork extensions installed. Check the bolts to make sure that they did not loosen in transit.)*

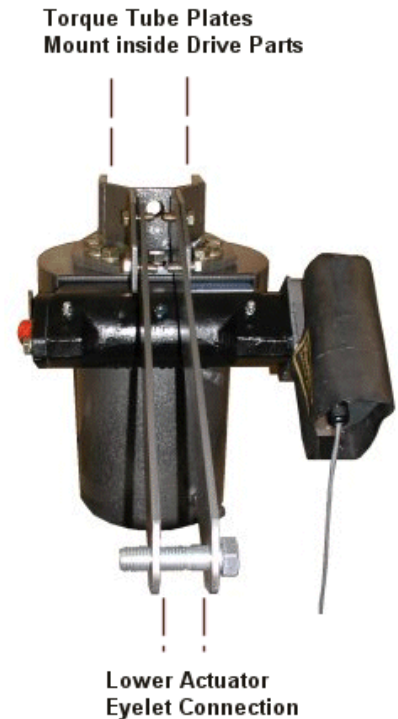
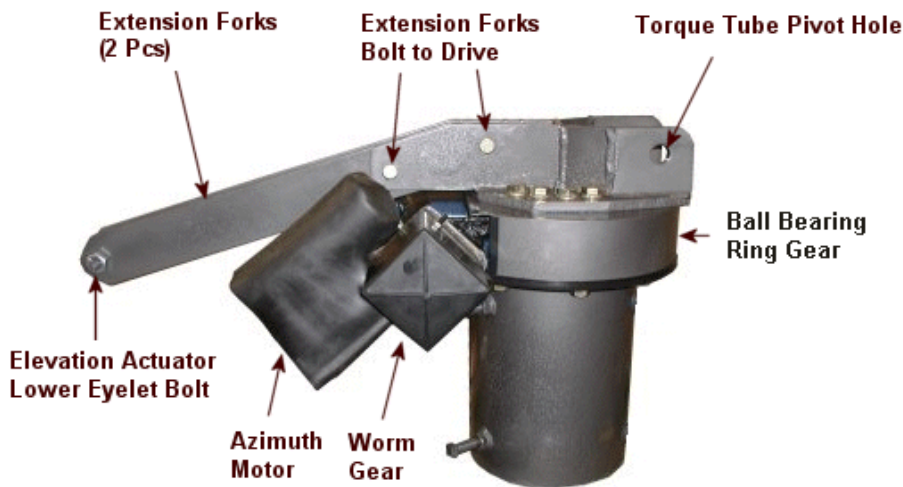

### **WARNING!**

The AZ-225 Drive weighs from 170 to 220 pounds! Do not use the Azimuth motor or tracker controller as "lift handles." You will damage the motor gearing or tracker controller if you put any unusual force on them.

You will have to be able to lift the AZ-225 Drive up, over and down on top of your mounting pole. Placing the drive on top of the pipe is at least a "two person" job. The drive is much easier to set using a boom and pulley arrangement or suspending it from a backhoe bucket or other appropriate method.

Make sure that the drive "seats" completely over the pipe. Back out the 4 set bolts and set aside if necessary to make sure that they do no catch on the top of the pipe. The 4 "cup point" set bolts "dig and cut" in to the steel pipe. Tighten the set bolts so that they put strong and equal pressure on the pipe mast. Each bolt should "show" an equal amount of thread when you are finished. **Each set bolt should be tightened to 80 Ft-Lbs of torque.**



## ELEVATION ACTUATOR ASSEMBLY FOR DUAL-AXIS OPERATION:

Do not unscrew the inner tube of the elevation actuator! This destroys the factory pre-set mechanical upper and lower limit switch settings. Install the elevation actuator. Center both the eyelet end (the top) of the elevation actuator inside the forks and the elevation actuator clamp eyelet (the bottom). Firmly tighten the locknuts on the bolt threads.

### UPPER CONNECTION

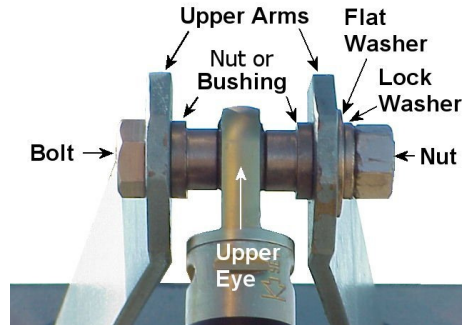

### LOWER CONNECTION

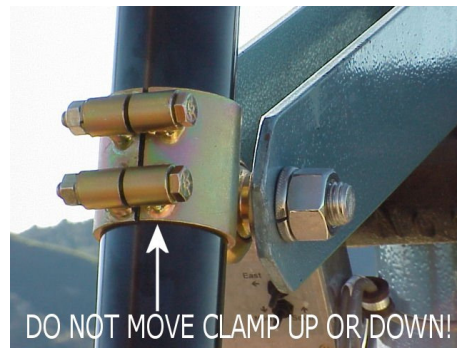

Your tracker is shipped with a 36" stroke linear actuator. Make sure that the motor armature (can) is on the upper side of the actuator. That ensures that any moisture that might collect will drain out and away from the electrical connections.

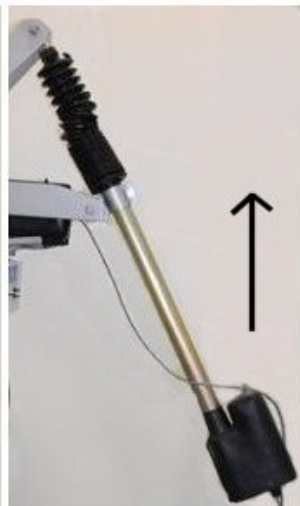

Motor Can is mounted away from the pole for proper drainage.

The actuator has a two cam-micro switch assembly that defines the limit of the extension and contraction. They are preset at the factory and there is no need to adjust them.

Do not unscrew the inner tube of the actuator when you are installing it. It will disturb the limit switch presets.

Do not change the location of the lower eye clamp. It is preset for your tracker. The clamp bolts have been pre-tightened to grip the body of the actuator securely. If you over tighten them, the clamp will deform the body of the outer tube. The deformations will cause scarring on the inner tube as it extends and withdraws.

If you have special circumstances or concerns then please contact your distributor or Array technologies immediately.

## AZ-225 HORIZONTAL TORQUE TUBE INSTALLATION FOR THE SMALLER 4" X 4" TORQUE TUBE

Consult the diagrams below for the bolt connections. Tighten the U-bolt Nylock nuts to 70 Ft-Lbs of torque



TIGHTEN NYLOCK 5/16" U-BOLT NUTS EVENLY.

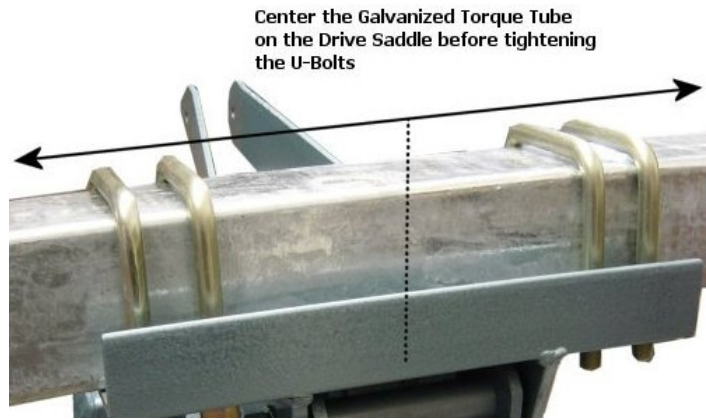

TIGHTEN EACH NYLOCK NUT TO 70 FT-LBS OF TORQUE.

## AZ-225 HORIZONTAL TORQUE TUBE INSTALLATION FOR THE LARGER 6" X 6" TORQUE TUBE

Consult the diagrams below for the bolt connections. Tighten the channel-bolt Nylock nuts to 70 Ft-Lbs of torque

### AZ-225 Saddle Clamp Assembly

(Largest "Uber" Tracker Models)

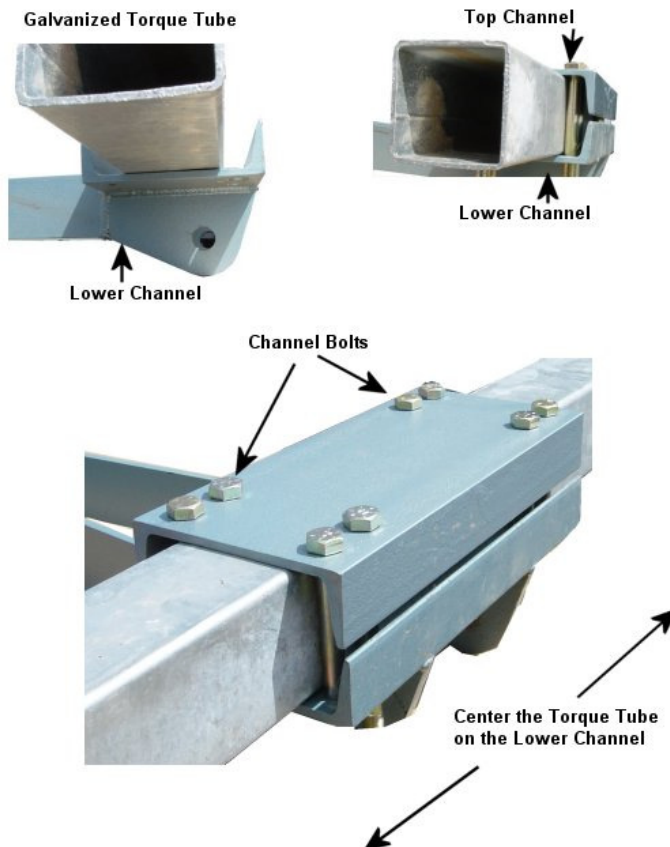

## Section 4

# Install the Module Support Frame Torque Tube

**SECTION 4 NOTES:** Nearly every nut and bolt will be left "finger-tight" until all the modules are mounted and the frame is "squared-up." So allow for a small amount of "play" when putting the array together. You will snug up all the bolts and nuts when all the modules are mounted and the frame is complete.

**Installation Tip:** The PV modules may be mounted to the rails at this time - prior to installation onto the torque tube assembly. This removes the difficulty of mounting each individual module to the rails while you working off a ladder or above your head.

However, placing the heavier, assembled module sub-array onto the torque tube assembly requires at least two people. For either application, the web of the module mounting struts must be oriented toward the outer ends of the modules.

## Procedure for Installing Solar Modules on Wattsun Tracker Universal Rails

### *Examples of Three and Four Column Tracker Frames*

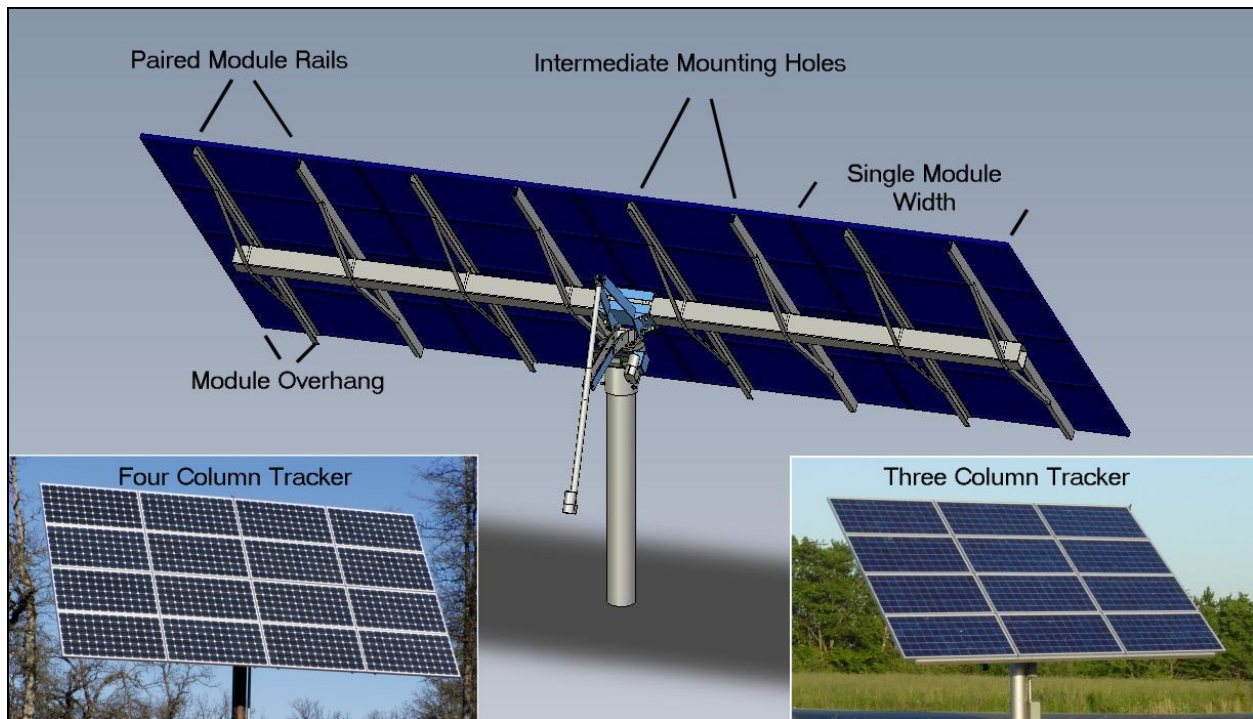

Wattsun Tracker frames are manufactured to hold the solar modules in a rectangular grid. A pair of vertical module rails will mount a group of modules in "landscape" format.

The completed frame is made up of one to four pairs of module rails.

Each rail is u-bolted onto the horizontal "steel spine" of the tracker called a torque tube. If the rails they are longer than ten feet then an additional support under-angle is included – one for each rail. Wattsun Trackers come with all the hardware to assemble the tracker and mount the modules.

The end user supplies the appropriate mounting pipe and engineered foundation.



## BUILDING THE FRAME AND RACKING THE MODULES: DO YOU MOUNT ONE PIECE AT A TIME OR BUILD SUB-ARRAYS?

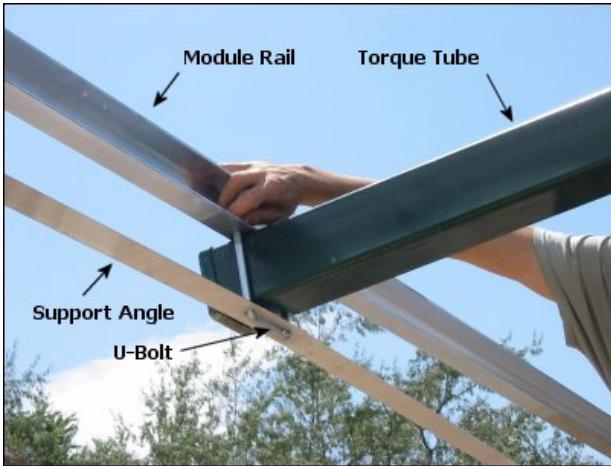

Module Rail & Support Angle Detail  
From the bottom up the Procedure is:  
Bolt > Support Angle > Tube > Rail > Washer > Nut



One installer, one piece at a time approach.  
Modules are being used to “square-up: the frame.  
Notice how the modules overhang the Rails.



Sub-Array Approach: Requires a lot of people power.  
Notice that the rails bolt to the intermediate module holes.  
Lift by the tracker rails only, not the module frames!



Lifting and bolting the sub-array onto the tube.  
Typically a 3-person job: 2 lifters, 1 bolter.  
Lift by the tracker rails only, not the module frames!



The “one piece at a time” approach can get very tiring. The installer is working with their arms and hands above their head. We encourage installers’ to wear a Hard Hat.

Leave all frame and module bolts “finger tight.” Once you finish the frame building and module mounting, you can go back and “square up” the array. Then tighten all nuts with a wrench.

**NOTE:** If you ever “under populate” the array frame, leave any unused space at the top of the frame. If the frame is not totally filled out, then the greatest weight should be on the lower sections of the frame.

*Tools Required: Frame Assembly and Module Mounting*

Tool	Required to Fasten
3/4 " Open End Wrench	Nylock Nuts for the Module Rail Assembly U-Bolt
7/16" Open End Wrench	Flange Nut for 1/4" x 3/4" Module Mounting Bolt
1/2 " Open End Wrench	Flange Nut for 5/16" x 3/4" Module Mounting Bolt
Rubber or Plastic Head Mallet	Small adjustments to shift the Rail Assembly sideways

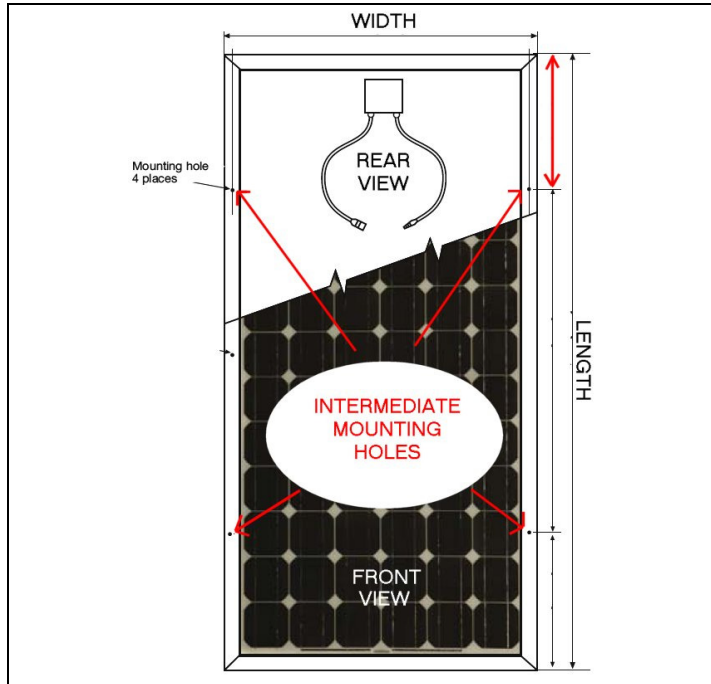

Step 1

The modules get mounted to the rails using the intermediate holes. Locate the intermediate mounting holes on the frame of your module.

In general, they are placed from 7" to 16" in on the long side (Length) when measured from the frame edge short side (Width).

Each manufacturer has unique hole patterns. Your mounting holes are made to accommodate either 1/4" or 5/16" module mounting bolts. The bolts are supplied with your Wattsun Tracker.



Step 2

Identify your module mounting bolts and nuts from the hardware kit. The module bolts are labeled and are either 1/4" or 5/16" diameter.

Note that both the interior faces of the nut and bolt are made to cut into the module frame. They do not require any type of washer.





### Step 3

There are four bolts and nuts per module. Pre-mount the module bolts so that the serrated nuts will dig into the underside of the module frame.

Do not tighten the bolt fully. Leave it about one full turn loose so it will glide easily in the module track.



### Step 4

Measure and record the "center to center" distance of the intermediate mounting holes. This dimension sets the spacing of the mounting rails.

Each pair of mounting rails typically holds from 3 to 4 large modules. Typical rail spacing might be from 24" to 35" apart.

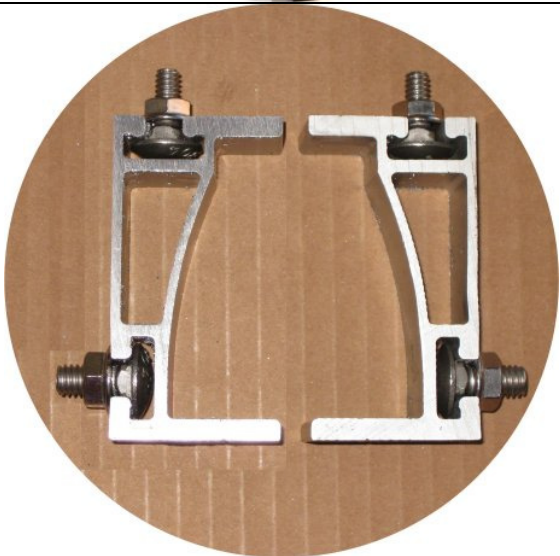

*( Cross section view of the module rails and bolt connections )*

### Step 5

Remove a pair of modules rails from the frame bundle. They will be bolted on top of the torque tube so that the "legs" of the channel face inward towards each other.

The bolts on in the top track are the module fasteners and the bolts in the side track secure the module rail support angle.



#### Step 6

Pull the module rail u-bolts, washers and locknuts from the hardware kit. There will be one set of u-bolt hardware per module rail.

If your module rail is longer than 10 feet then there will be a corresponding support angle in your frame bundle.



#### Step 7

If you have a three column tracker (3 modules wide) then your first rail set will be centered over the drive head and straddle the centerline of the torque tube.

If you have a four column tracker (4 modules wide) then your first rail set will be to the right or left of the centerline of the torque tube.  
(Step 1)



#### Step 8

Pass the u-bolt through the holes in the support angle. Push the u-bolt up and around the torque tube and into the receiving holes in the bottom of the module rail.

Place a 1/2" flat washer over each leg of the u-bolt and then secure a 1/2" Nylock nut over each leg. Do not tighten the Nylock nut completely. Leave a little slack so the rail assembly can be slid horizontally along the torque tube to accommodate your "center to center" measurement.  
(Step 4)

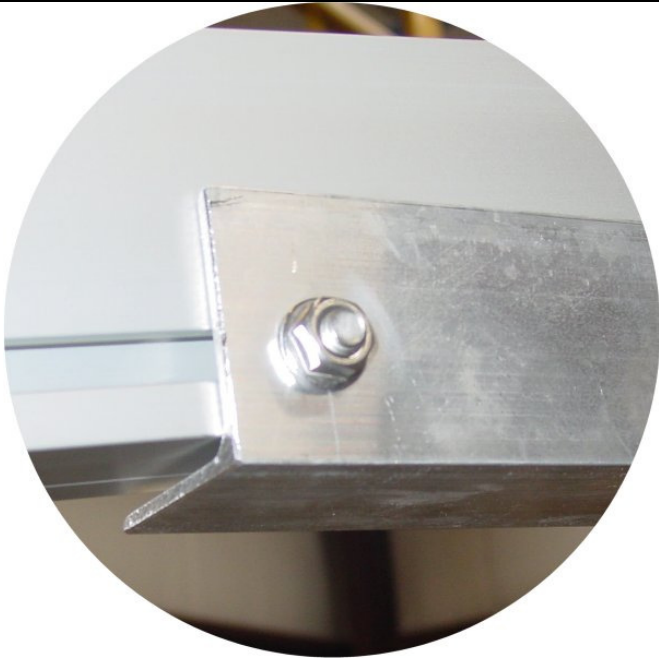

#### Step 9

Carefully fold up the support angle so that it makes contact with the underside of the module rail. The hole in the side face of the angle should be aligned over the side track of the module rail.

The support angle connection to the side of the module requires that you slide a 5/16" bolt along the side track until it aligns with the hole in the end of the support angle.

Do not tighten the bolt completely. Leave a little slack so you can square up the frame at the end of the installation.



#### Step 10

Use a tape measure and gap the module rails a distance equal to the "center to center" intermediate hole spacing. (Step 4)

Be sure that you are spacing from the centers of both top tracks in the rails. You might have to loosen the u-bolt Nylock nuts so that you can easily adjust the rail assembly along the torque tube.

The racked modules and frame will be squared up at the end of the mounting procedure.



#### Step 11

Make sure that the tracker is in the "stow" or nearly horizontal position and that the elevation bar or actuator has been installed.

Line up the module bolts into each track. You might have to spin the bolt a bit so that the square shoulder of the bolt line up in the slot. Push the module forward and repeat the process with the other side of the module.

Once the module is properly positioned on the rails, tighten the serrated module nuts until they are finger tight.



### Step 12

Continue populating the array with the rail assemblies and solar modules. Even out the spacing between the module frames (typically 1/4" in 1/2") and square-up the frame assembly. Go back and tighten up all the bolts and nuts left intentionally loose.

Start with the rail assembly u-bolts Nylock nuts, then proceed to the support angle fasteners (if provided) and finish up with each module mounting bolt and nut.



**WARNING! PLEASE READ THIS GUIDE COMPLETELY BEFORE CONNECTING POWER TO THE CONTROLLER. YOU CAN DAMAGE THE CONTROLLER OR INADVERTANTLY POWER UP THE TRACKER AND CREATE A HAZARDOUS SITUATION. NEVER APPLY POWER TO THE CONTROLLER OUTPUT WIRES! THE CONTROLLER WILL BE DAMAGED AND THE REPAIR CHARGE IS NOT COVERED UNDER WARRANTY.**

**For Installations in the Tropics:  
(20 degrees North latitude to 20 degrees South latitude)**

**Array Technologies does not encourage the use of Dual-Axis Trackers in “low latitudes.” Wattsun Single-Axis Trackers are preferred in the tropics. Contact Array Technologies for performance data and recommendations.**

The azimuth tracker works by rotating the PV array about the pipe mast then tilting the array to the proper elevation angle. Therefore, for installations near the equator it will be necessary to rotate the azimuth tracker 180 degrees twice a year. Depending upon the time of year, trackers in this region will find the sun anywhere from north, south, or directly overhead of its location, making manual rotation necessary.

For example, at the equator rotation of the tracker will need to occur on the first day of spring and the first day of fall. The array should point north on March 21st, and rotated 180 degrees to point south on September 23rd.

To rotate the tracker on the pipe mast, loosen the four set bolts on the azimuth drive, rotate the tracker and re-tighten. Marking the pipe mast for the two yearly positions, aids in seasonal adjustment. You must also leave sufficient output wire lengths from the array to allow for rotation.

**24 VOLT TRACKER CONTROLLER SPECIFICATIONS**

**Controller input power specifications:**

The input voltage range is 23 to 50 volts DC.

**Use a Wattsun Voltage adapter to power the controller for nominal voltages other than 24 VDC.**

**Tracker controller wiring and drive motor wiring:**

Do not connect the motor output wire harness to a power source! Connecting any of the controller output wires to the PV array or a power source will cause permanent damage to the controller and void the warranty.

**Power supply connection options:**

The input power leads are Red (positive) and Black (negative) wires in the two-wire cable mounted on the left-hand side of the controller chassis. The input wires are clearly marked with a tag.

**Power consumption, including motors:**

Less than 10 watt-hours per day.



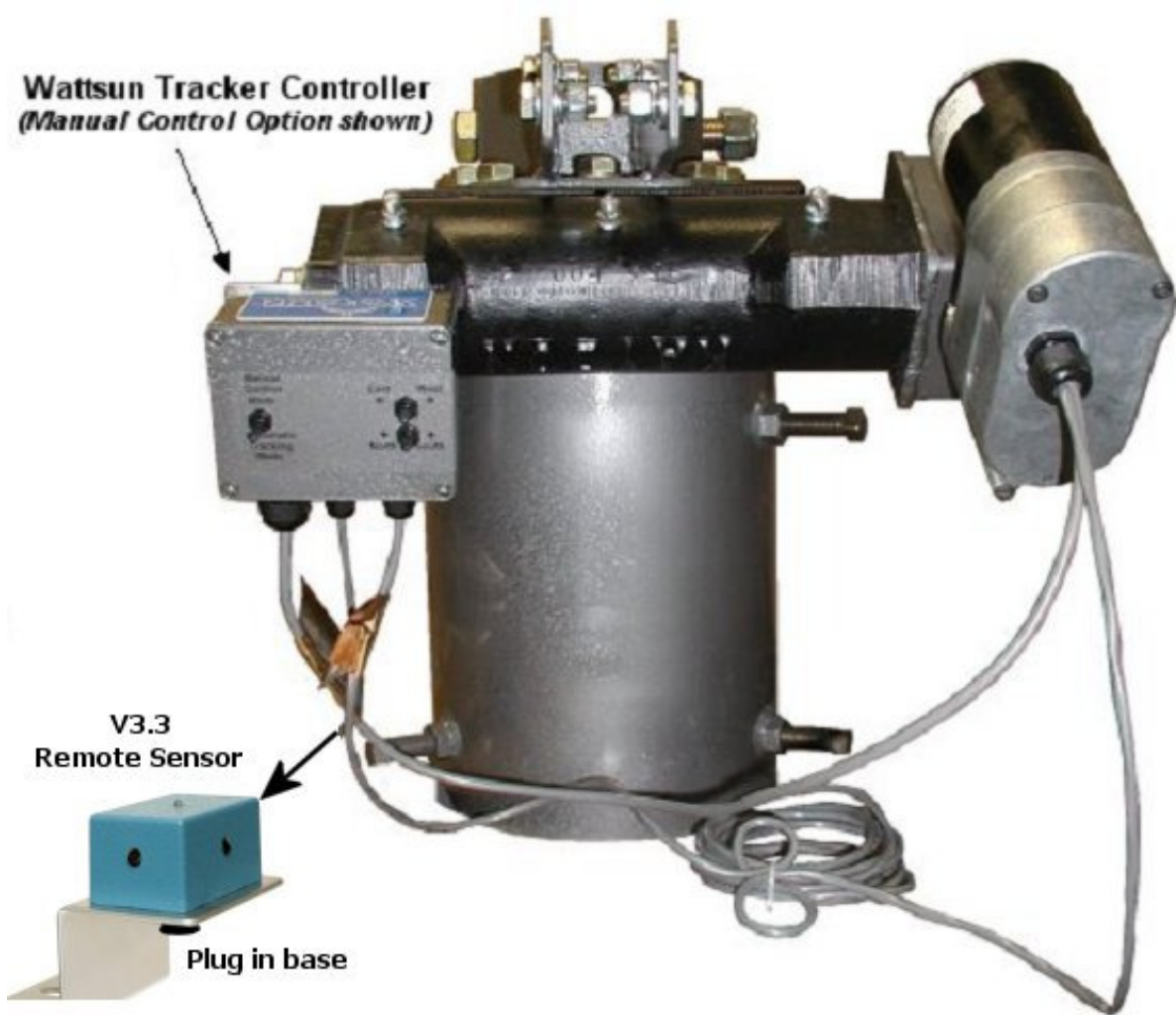

**THE TRACKER CONTROLLER IS PREINSTALLED ON THE AZ-225 DRIVE.**

**WARNING!**

**MAKE THE "POWER IN" CONNECTION LAST!**

**DO NOT ENERGIZE THE WATTSUN SOLAR TRACKER CONTROLLER UNTIL YOU HAVE COMPLETED THE ENTIRE TRACKER INSTALLATION.**

**TWO ADDITIONAL CONTROLLER CONNECTIONS THAT GET MADE BY THE INSTALLER:**



Sensor mounts on the top edge of the array. Center it on the top to make for a neat wire run. The remote sensor wire plugs into the base of the sensor. Twist the lock ring!



There is a two-wire "pig-tail" that is prewired into the azimuth motor. It needs to be connected to the elevation actuator motor.

## **WATTSUN TRACKER CONTROLLER: FUNCTION AND FEATURES.**

### **OVERVIEW**

Wattsun™ Solar Trackers utilize a patented, closed loop, optical sensing system to sense the sun's position and track it. The sun sensors are mounted on the remote chassis and feed information to the control electronics about the direct component of sunlight available, the diffuse amount of sunlight, the total amount of sunlight as well as the differential amount of sunlight on opposing sensors. Based on this information, the controller seeks to equalize the sunlight received by opposing sensors for each axis.

The controller circuitry automatically adjusts the tracker sensitivity. It increases the sensitivity with increased direct sunlight and decreases the sensitivity with scattered or diffused light - present during cloudy conditions. This enables the tracker to eliminate undue hunting in cloudy or overcast conditions when the sunlight is scattered. It also adjusts according to the total amount of light received by the sensors.

When the tracker controller is connected to a battery bank or constant power source, the controller senses sunset and returns to the sunrise position. When it is powered directly from the PV array, the tracker returns to sunrise at first morning light. The controller uses energy integration circuitry, enabling the tracker to move with as little as 20ma of available current.

The tracker controller sends a signal to the DC gear motor that moves the PV array to a perpendicular position relative to the sun's rays. The motors are small, fraction HP, low voltage, gear motors that move the tracker into position. The gearing is designed such that high winds or other forces cannot drive the tracker back. Because they are DC drive motors, one polarity moves them in the forward direction and reversing the polarity moves them in the opposite direction. When the controller wants the tracker to move, it sends a signal of the appropriate polarity to the DC gear-motor. Once the tracker has moved to the "on track" position, the controller electrically "brakes" the motor to stop movement that results in greater tracking accuracy.

### **STANDARD FEATURES OF YOUR WATTSUN CONTROLLER**

- ◆ Controller mounted on the drive for maximum accessibility.
- ◆ Sensor mounts independently of the main chassis.
- ◆ Dip switches to test the Azimuth and Elevation Limits.
- ◆ Dip switch to set nighttime Elevation (stow) position.
- ◆ Controller outputs are short circuit protected and will limit the output current to 3 amps.
- ◆ Inside controller chassis are light sensitivity adjustment potentiometers for Azimuth and Elevation.
- ◆ Controller is equipped with a 5-amp automotive spade type fuse (ATO) inside the controller chassis.
- ◆ Self-resetting thermal fuse that shuts off power to the tracker motors in case of obstruction.
- ◆ Filtering to protect the tracker motor against "noisy" PWM charge controllers.
- ◆ Improved lightning protection.

### **DUAL-AXIS NOTES**

The controller prioritizes the azimuth (east/west) axis. If the azimuth axis is not on track, the elevation axis will not function. Once the azimuth axis has locked onto the sun and stops moving, the elevation axis adjusts. However, if you power the controller from a battery bank, you can choose to allow simultaneous azimuth and elevation motion.

### **NOTE**

The Array Direct method is not recommended for powering Azimuth-Drive Trackers. You can easily lose of the available 30% of a long summer day!

# General Wiring Diagram for a Wattsun Solar Tracker Controller AZ-225 Drive manufactured after August 21, 2003

**WARNING!**  
Backfeeding power into controller output wires will result in damage to the controller.

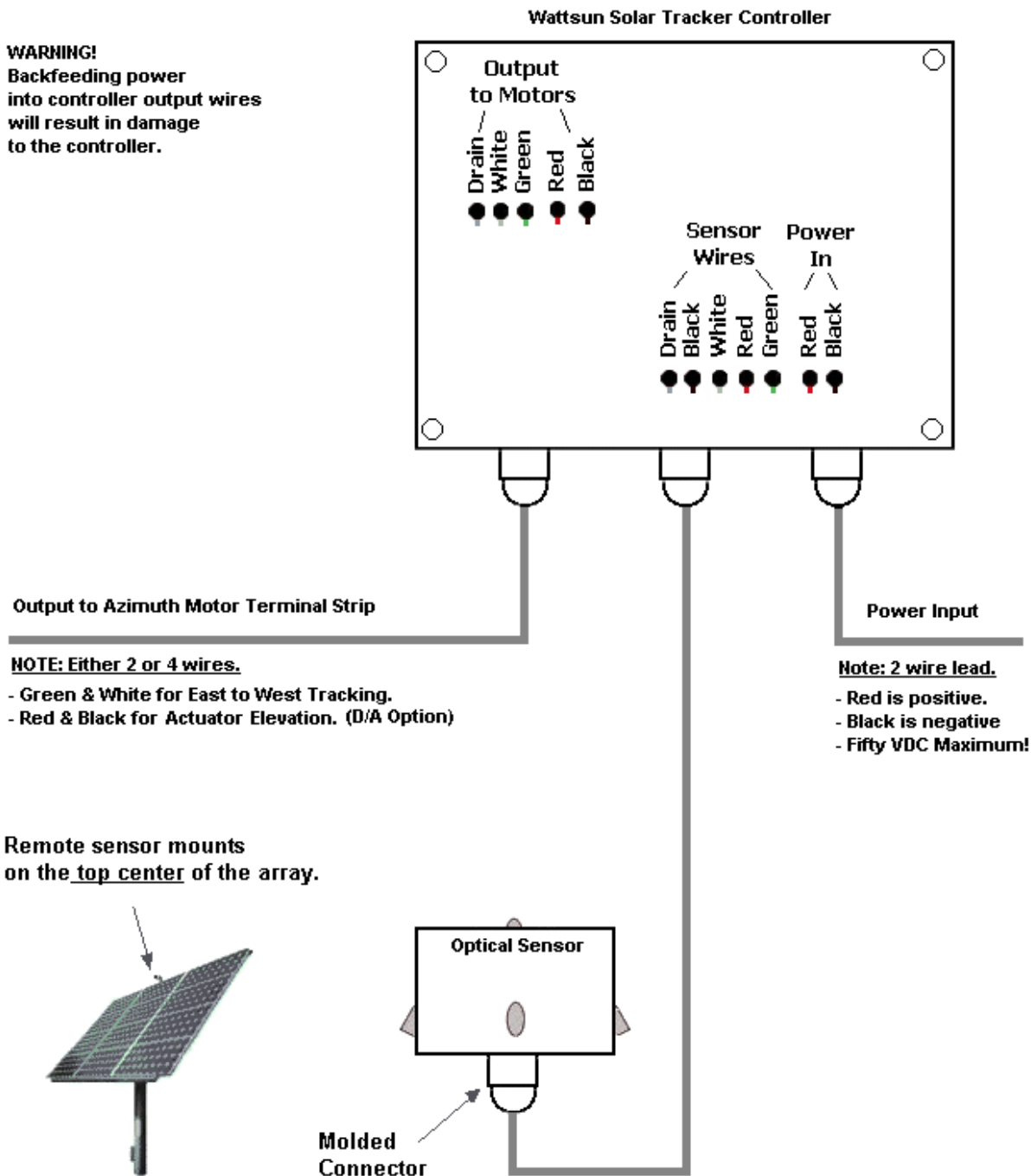

Terminal	Controller Output	Motor
1	White	Azimuth Drive
2	Green	Azimuth Drive
3	Red	Elevation Actuator
4	Black	Elevation Actuator

## 5.1) THE AZMUTH MOTOR TERMINAL STRIP (PRE-WIRED AT THE FACTORY)

It is unlikely that you will need to access the wiring inside the Azimuth Motor. The Azimuth Motor Terminal Strip is pre-wired at the factory. It serves as a central connection point for motor power wires. The 4-wire Controller output lead and the Elevation Actuator lead share entry into the Azimuth Motor Cover through the rain tight plastic strain relief.

A four-wire lead enters in from the Controller and is divided into two pairs. The first pair (White & Green) controls the East-West Azimuth movement. The second pair (Red & Black) “passes through” and controls the North-South elevation movement. The Elevation Actuator power lead exits azimuth motor cover through the strain relief and will be connected to the actuator motor by the installer.

### AZ-225 AZIMUTH MOTOR WIRE CONNECTIONS

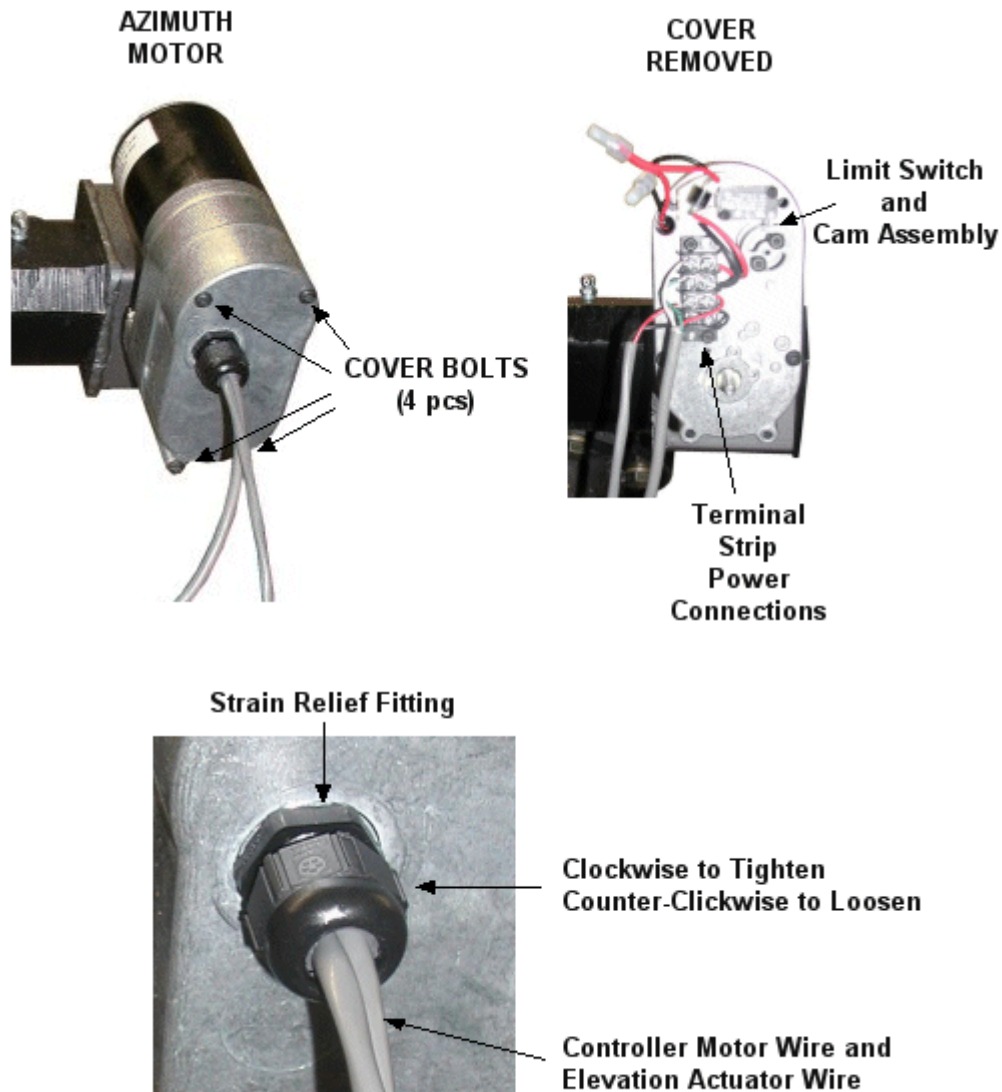

**AZIMUTH MOTOR: TERMINAL STRIP WIRING DIAGRAM  
(POWER CONNECTIONS ARE PREWIRED AT THE FACTORY)**

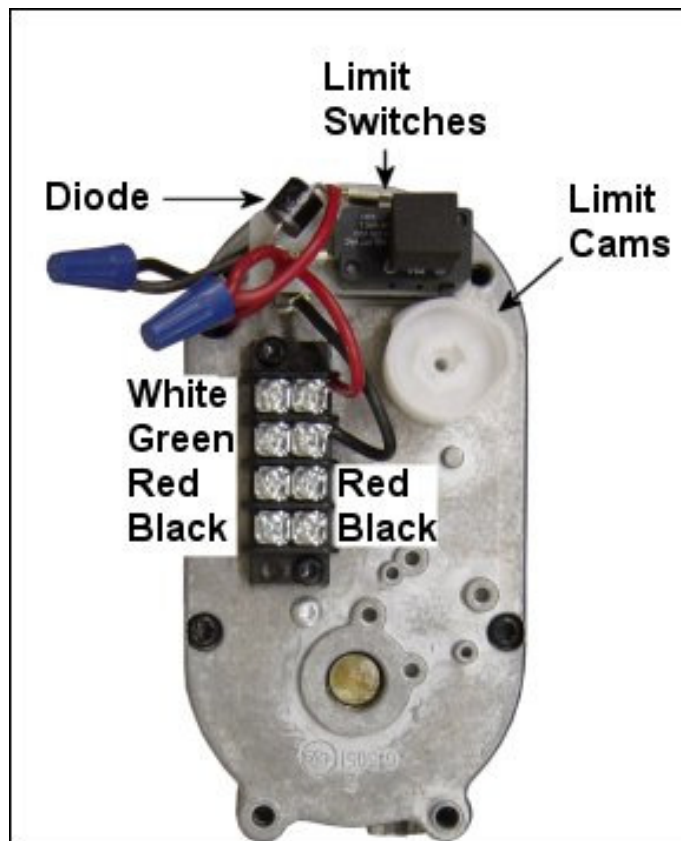
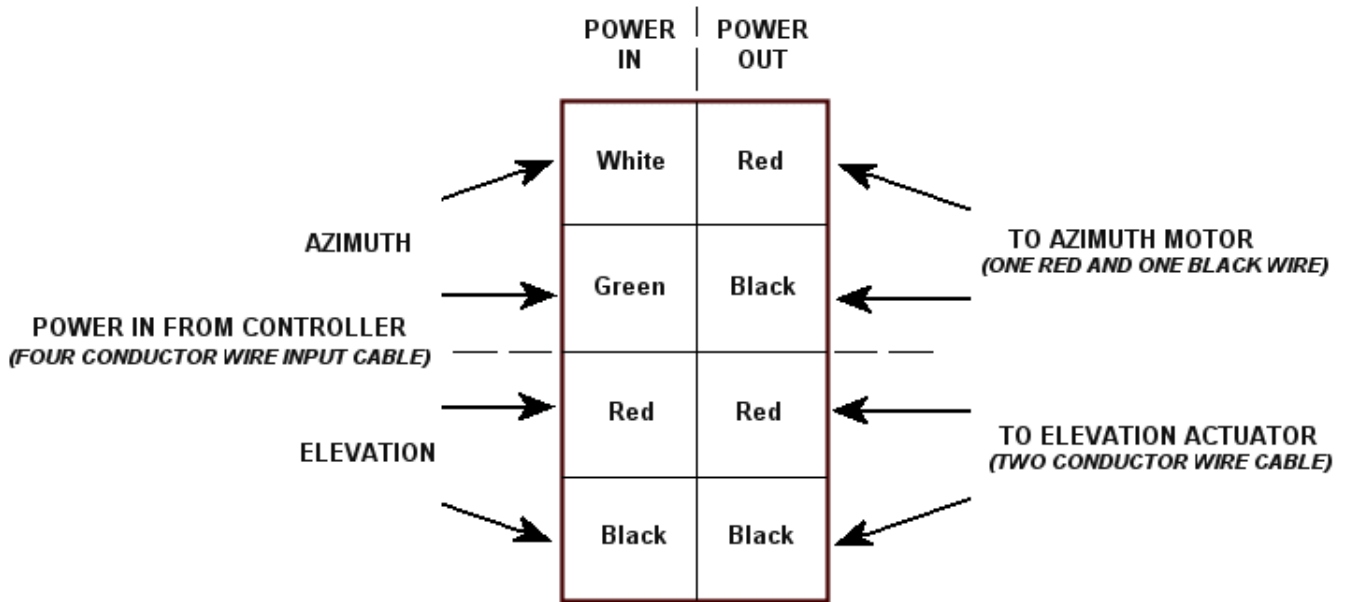

**WARNING!**  
**THE LAST CONNECTION MADE IS FROM YOUR POWER SOURCE TO THE TRACKER CONTROLLER! DO NOT ENERGIZE THE WATTSUN SOLAR TRACKER CONTROLLER UNTIL YOU HAVE COMPLETED THE ENTIRE TRACKER INSTALLATION.**



## 5.2) MOUNTING THE REMOTE SENSOR



### MOUNT THE REMOTE SENSOR ON THE TOP OF THE ARRAY

The sensor mounts on the **TOP CENTER (or near the center) of the PV array**. Most modules already have a hole in the frame that you can use. If your modules do not have an "end hole" then you will need to drill a 1/4" hole in the frame to mount the sensor. Slip a thin piece of wood between the module frame and

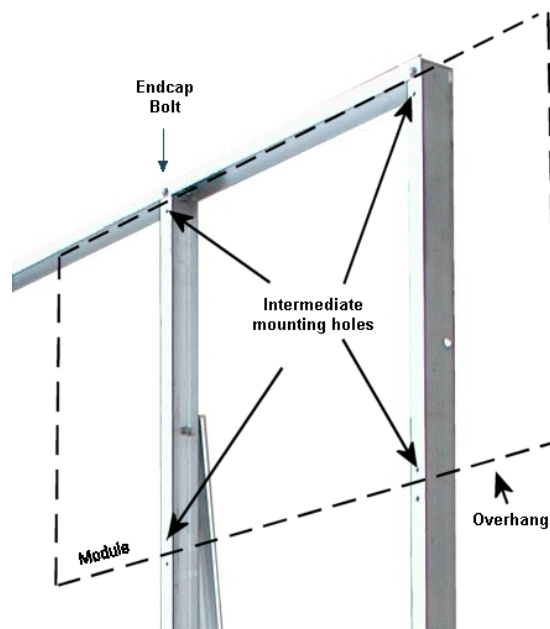
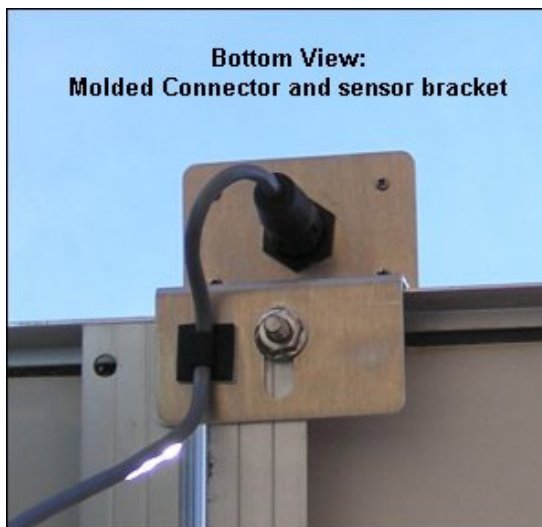

the back of the module. The wood "spacer" will keep you from inadvertently digging your drill bit into the back of the module once you have drilled through the frame.

If the modules in your array mount in "landscape" format and you have aluminum "endcaps" at the top and bottom of the array, then use the endcap mounting bolt and a strut near the center of the tracker. Make sure that the sensor has a clear view of the sky.

The wire coming from the sensor has a molded connector. It mates into the bottom of the controller. The controller connector has a groove inside to properly align the mating pieces. Match up the "tongue and groove" of both connectors, push them together and twist the locking ring to secure the connection.

**THE V3.3 SENSOR ORIENTATION IS DIFFERENT FROM THE EARLIER V3.x VERSIONS!**



The sensor needs to be above the plane of the array and have a clear view to the sky. Do not crowd it against the array or module frame. If the "eyes" don't have the freedom to see the sun then the tracker will behave oddly. The sensor's function is to make sure that equal amounts of light fall on all four sides.

Be careful not to damage the clear sensor on top. Its function controls "return to the east" at night.

**Warning! Never apply power to the actuator until it has been securely bolted into place. The linear actuator will tend to "unscrew" and will destroy the preset limit switch settings.**

- 6.1) Loosen the cover screws and remove the actuator cover. The plastic strain relief might have been inverted to protect it during shipping and hidden inside the actuator cover. Flip it around, reseal and snake the actuator power wire through the strain relief.

**WVW-VEN36" Linear Actuator**

TOP Terminal 1	Controller Red to Actuator Red
BOT. Terminal 2	Controller Black to Actuator Black

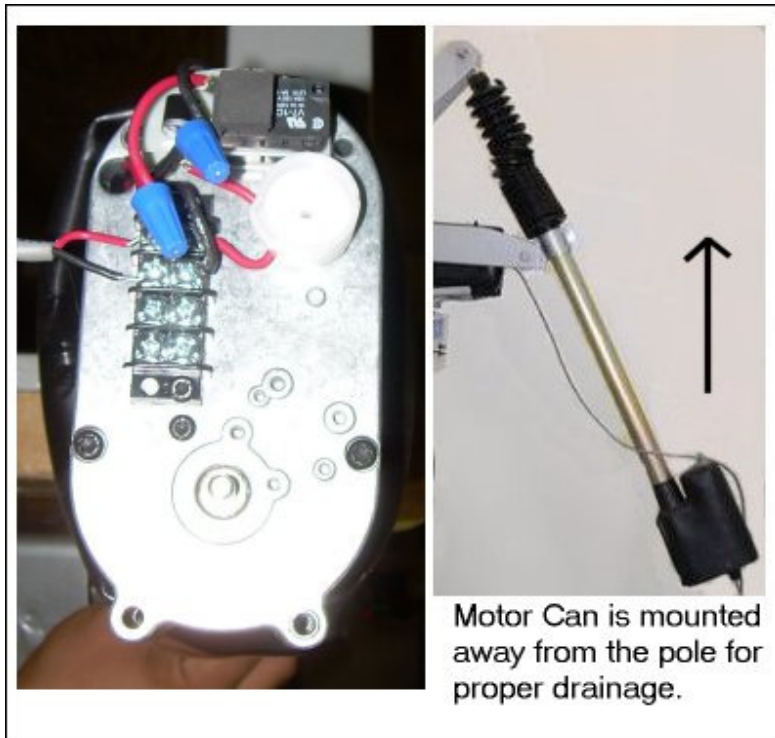

The actuator motors are DC motors. The polarity of the DC power coming from the controller will dictate the direction and movement of the actuator. Standard DC color codes are "relative" when applied to the actuator motor connections.

**DC input polarity during normal operation**

Extension ( Tilt Array Up )	Red +	Black -
Retraction ( Lay Array Flat )	Red -	Black +

## 7.1) POWERING THE WATTSUN CONTROLLER

**NOTE:** The azimuth-tracking limit switches are preset at the factory to accommodate the maximum range of East-West azimuth tracking.

Array Technologies recommends that you power your Wattsun Tracker Controller from a battery bank or grid-tied power source. The tracker will return to the East at sunset and the tracker has 270 degrees of azimuth tracking available. The dip-switch, sensor override features built into the controller are always available when you have constant power.

**DO NOT POWER THE CONTROLLER FROM THE ARRAY!** If you power the controller from the array, the tracker returns East in the morning. The tracker is limited to only 180 degrees of azimuth tracking arc. You will have to reset the Azimuth Motor limit switch cams to reduce the East-West travel. The dip-switch, sensor override features built into the controller will only be available during the day.

Sun Path Diagram for 40 Degrees N Latitude

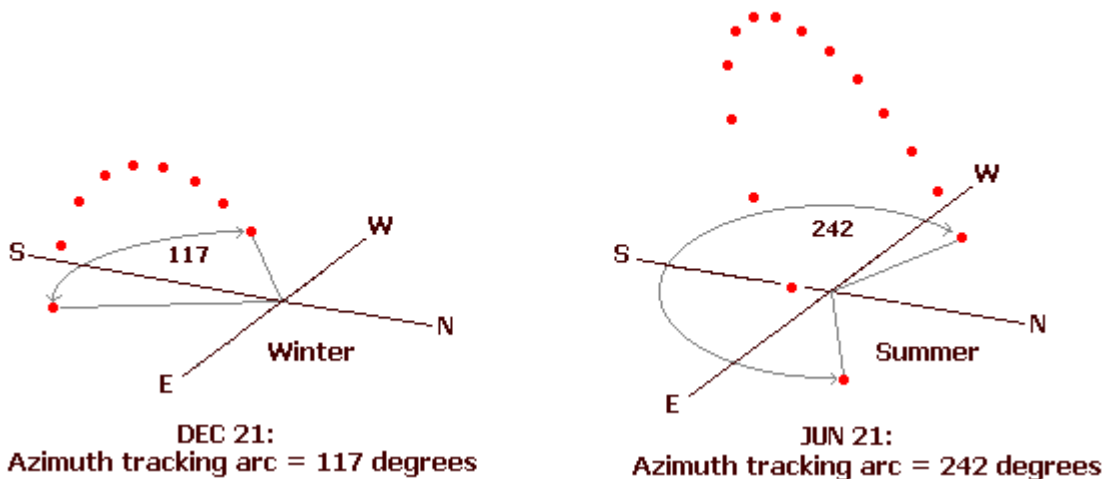

The diagram shows the hourly sun position for 40 Degrees North Latitude. During the winter, a tracker that is powered from an array returns in the morning and captures nearly all the 117-degree azimuth-tracking arc. However, during the summer, 242-degree azimuth-tracking arc is available. A tracker that is powered from an array only captures a 180-degree portion of that arc, and proportionally less power too - even if the tracker limits are set to their extremes.

7.2) On most Azimuth Trackers, the controller is already mounted to the drive head at the factory. The remote sensor and azimuth motor connections are already pre-wired and tested.

**Your installer should provide the appropriate fusing or DC breaker to protect any long wire runs and to disconnect to the controller power input.**

### 7.3) POWER CONTROLLER FROM A CONSTANT POWER SOURCE: (24 OR 48 VOLT DC BATTERY BANK OR GRID-TIED AC TO DC SWITCHING POWER SUPPLY)

- ◆ Powering the tracker controller from a battery bank or Grid-Tied Switching Power Supply is the RECOMMENDED WAY to provide power to your Wattsun Tracker Controller.
- ◆ The controller power-input leads can be connected directly to the main 24-volt battery bank.
- ◆ The tracker returns to the East at sunset and has 270 degrees of azimuth tracking available. The dip-switch, sensor override features built into the controller are always available when you have battery power.
- ◆ If the installation is for a 48-volt system, then you should use a Wattsun Voltage 48 to 24 VDC Converter to reduce the voltage to the tracker controller and motors.
- ◆ If the installation is for a "Battery-Less" Grid-Tie System, then you should use a Wattsun Switching Power Supply (WPS5RSF-24 or equivalent) to convert AC voltage to 24 VDC.
- ◆ The positive lead running from the battery bank, to the power input of the controller, should be fused with a 5 amp, current limiting, DC-rated fuse or equivalent DC breaker.
- ◆ Failure to fuse the input power wire at the battery bank may create a potential fire hazard.

**WARNING! Do not power the controller directly from a 48 VDC battery bank.** The "working voltage" of a 48 VDC bank exceeds the controller's 50 VDC maximum input rating. A 48 VDC bank can easily reach 59 VDC during an equalize cycle.

#### SIMPLIFIED WIRING DIAGRAM FOR BATTERY BANK TO CONTROLLER CIRCUIT

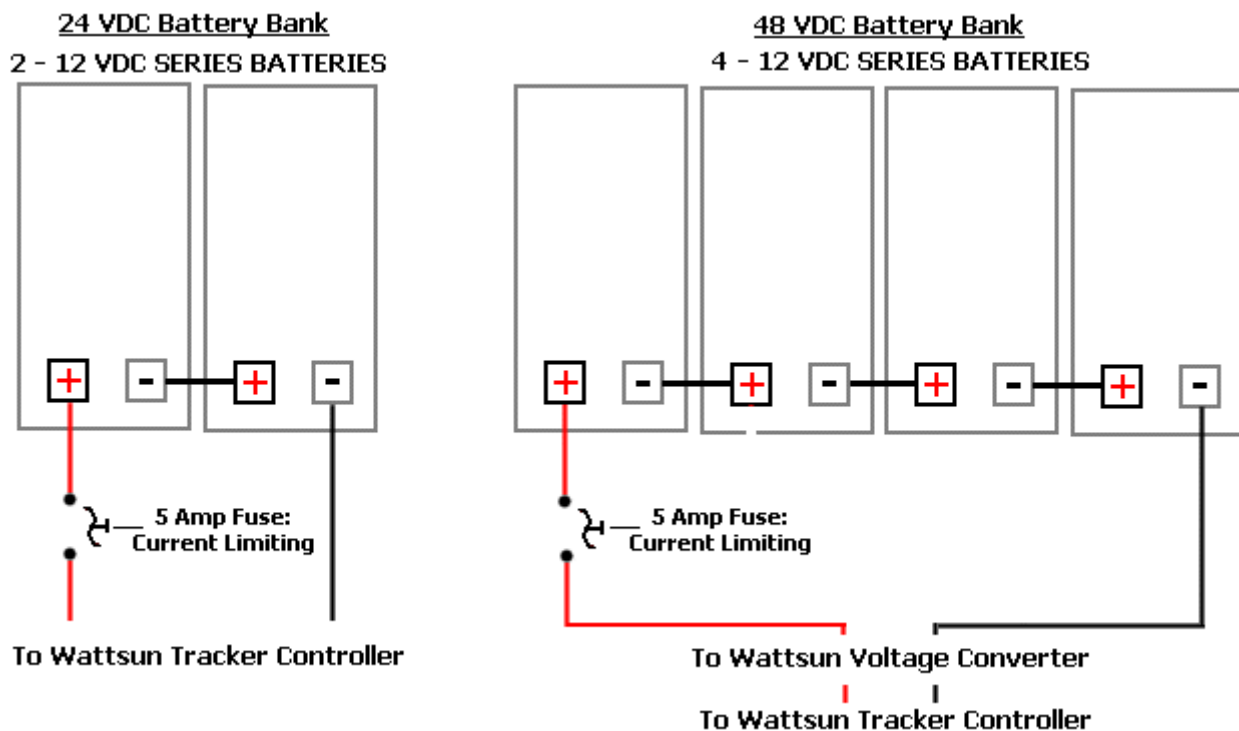

# CONTROLLER DIAGRAM, COMPONENTS, SWITCH SETTINGS AND FUSING

## Interior View of a Dual-Axis Controller for Azimuth Trackers

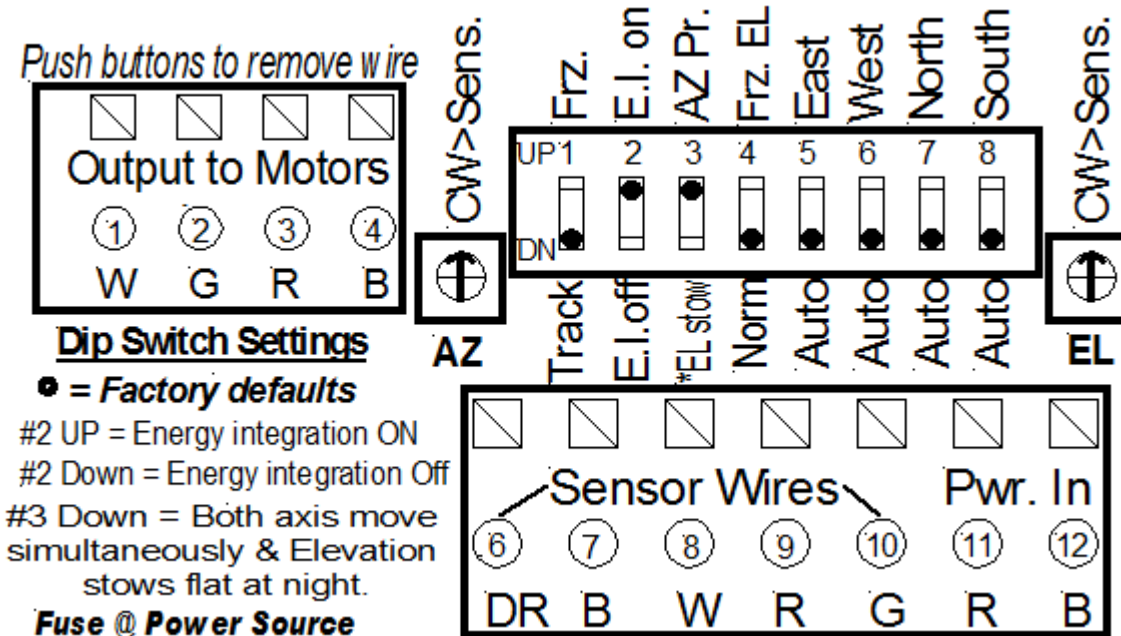

### DIP SWITCH SETTINGS

Dip	Default	Up Position	Down Position
#1	Down	Freeze Tracker - Temporary off only	<b>Normal:</b> Auto Track
#2	Up	<b>Normal:</b> Energy Integration ON: Allow for low current sources to power the tracker controller.	Energy Integration OFF: Lowers the voltage input threshold to power from a low state of charge 24 VDC battery.
#3	Up	<b>Normal:</b> Prioritize Azimuth Axis. Move Azimuth 1 <sup>st</sup> , Elevation 2 <sup>nd</sup> . Freeze Elevation at night.	Move Azimuth and Elevation at the same time and lay the tracker flat at night. (5 Degree tilt).
#4	Down	Disable Elevation Actuator Auto Track (Winter mode: Maintain a steep tilt to shed snow)	<b>Normal:</b> Dual-Axis Tracking ON
#5	Down	Manually move East.	<b>Normal:</b> Auto Track.
#6	Down	Manually move West.	<b>Normal:</b> Auto Track.
#7	Down	Manually move North.	<b>Normal:</b> Auto Track.
#8	Down	Manually move South.	<b>Normal:</b> Auto Track.

### DIP SWITCH

Small rocker switches that affect controller operation. Switches 5,6,7 & 8 move the tracker: Allow for a 3 second delay for the motors to engage after "throwing" a switch from Auto Tracking. Return to the Normal position for Auto Tracking!

### LIGHT SENSITIVITY TRIM POTS

Inside the controller chassis are two adjustment potentiometers for light sensitivity. They are a single-turn pot: clock-wise rotation equals greater sensitivity, counter clock-wise rotation equals lower sensitivity. This adjustment is factory pre-set and should only be adjusted by qualified personnel. Do not turn more than ½ turn in either direction!

### INTERIOR FUSE

Replaceable 5-Amp automotive spade type fuse (ATO). Do not replace with a larger amp rated fuse! Gently pull the fuse out of the holder to inspect or replace. It is usual to see a small spark when reconnecting the fuse. A 7.5-Amp fuse is the maximum fuse allowed. A 10-Amp fuse or higher will cause trouble!



**OVERVIEW: OPERATING THE TRACKER CONTROLLER AND SETTING THE DIP SWITCH OPTIONS.**

Your tracker controller is preinstalled and “ready to go” as soon as you connect power it. The following procedure tests the controller's operation, the full range of motion of the tracker and to set some field selectable options. You can turn the tracker on and off or choose to bypass the Energy Integration Circuit. If you have a Dual-Axis tracker, you can make the tracker lay nearly flat at night or disable the auto-tilt function entirely.

- 8.1) Survey your work area:** You are going to test the tracker range of motion. Be aware that your tracker is set to Auto-Track and will start moving as soon as power is connected to the controller! Make sure that there is nothing in the way of the tracker when it begins to rotate. A common mistake is to leave a ladder standing nearby. Inspect the wiring from the array to the controller and your junction box. Make sure that all wire service loops are long enough and that the wires are free from binding at all pivot points. Is there enough slack in the wires to accommodate full azimuth rotation in either direction?
- 8.2) Remove the controller cover:** Loosen the 4 Phillips bit machine screws and remove the metal cover of the controller. Keep the cover and gasket free of dirt.
- 8.3) Switch #1- Auto Tracking:** ON when pushed in at the bottom. Depress the top rocker of Dip Switch #1 to the UP position to temporarily freeze the tracker position. Push in at the bottom to return to Auto Tracking when you are finished testing the controller.
- 8.4) Switch #2- Energy Integration:** ON when pushed in at the top. Always Leave UP (E.I. ON) unless you are powering the tracker from a nearly depleted 24VDC battery bank. The down position (E.I. OFF) bypasses the Energy Integration Circuitry. This allows the tracker to operate when the battery voltage is below 23.5 VDC
- 8.5) Switch #3 – Dual Axis, Maintain Array Tilt at Night:** ON when pushed in at the bottom. The Azimuth Drive motor operates 1<sup>st</sup> and the Elevation actuator operates 2<sup>nd</sup>. At night, the array maintains a steep tilt. When the switch is pushed in at the bottom, both tracker motors can operate at the same time and the array will LAY FLAT at night. Use only in situations where there are high winds and no snow during the evening hours.
- 8.6) Switch #4: Dual Axis, Elevation Tracking:** ON when pushed in at the bottom. The tracker will automatically track the sun up and down in the sky. OFF when the switch is pushed in at the top, the elevation tracking is stopped. Use in high-latitude sites where the days are short, the sun is low in the sky and snow loading on the array is an issue.
- 8.7) Switch #5: EAST OVERRIDE** OFF when pushed in at the bottom. Manually move the tracker East by depressing the top of Dip Switch #5. The tracker will track to the East and then stop once the Limit Adjustment Cam touches the limit switch. Return it to OFF position for AUTO TRACKING.
- 8.8) Switch #6: WEST OVERRIDE** OFF when pushed in at the bottom. Manually move the tracker West by depressing the top of Dip Switch #6. The tracker will track to the West and then stop once the Limit Adjustment Cam touches the limit switch. Return it to OFF position for AUTO TRACKING.
- 8.9) Switch #7: NORTH OVERRIDE** OFF when pushed in at the bottom. Manually move the tracker North (de-elevate) by depressing the top of Dip Switch #7. The tracker will “flatten out” and stop once the elevation actuator's internal limit has been reached. Return it to OFF position for AUTO TRACKING.
- 8.10) Switch #8: SOUTH OVERRIDE** OFF when pushed in at the bottom. Manually move the tracker South (elevate) by depressing the top of Dip Switch #8. The tracker will track to the North and then stop once the elevation actuator's internal limit has been reached. Return it to OFF position for AUTO TRACKING.
- 8.11) Setting the Sensor Light Sensitivity:** The sensor sensitivity is preset at the factory. Inside the controller chassis are two adjustment potentiometers for light sensitivity. They are a single-turn pot: clockwise rotation equals greater sensitivity, counter-clockwise rotation equals lower sensitivity. Only qualified personnel should perform this adjustment. Do not turn more than ½ turn in either direction!

**VIEW OF A DUAL-AXIS CONTROLLER with V3.3 Sensor**

**V3.3 Motor  
Wire Connection**

White  
Green  
Red  
Black



**DA Option:  
Red and Black  
(Different than  
earlier versions.)**



**To  
Motors**

**From  
Sensor**

**24 VDC  
Power In**



**V3.3 Sensor**



Drain  
Black  
White  
Red  
Green  
Red  
Black

Sensor In      Power In

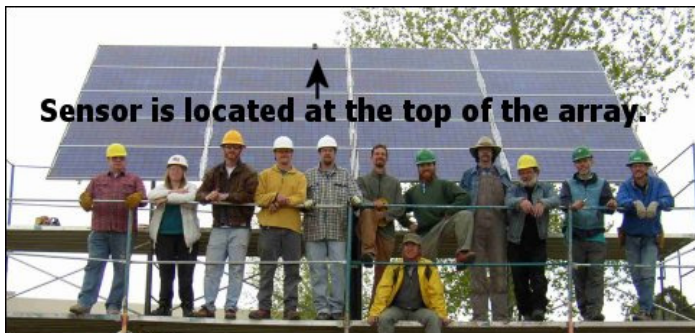

**Sensor is located at the top of the array.**

**KEEP YOUR FINGERS AND TOOLS AWAY FROM THE GEARING BENEATH THE PROTECTIVE COVER OF THE DRIVE!**

The limits for your tracker are preset at the factory. Please contact Array Technologies if you want to change your settings.

However, for clarification please review the images below. There are two cams: one stacked atop the other. The bottom cam controls the East limit and the top cam controls the West limit. As the tracker motor operates and moves the tracker, the cams rotate too. Eventually, a "nub" on the cam contacts a limit switch and stops the tracker. The tracker is free to rotate in the opposite direction if the sensor tells it to or if you are in the manual control mode.

The East cam is preset to the maximum East (wide open) position at the factory and acts as a reference for the West cam. The cams are held and meshed together with a retaining spring. Rotate the West cam (top cam) clockwise decrease the westward travel of the array. Make your adjustments in small increments. And always Test the range of motion after making any adjustment!

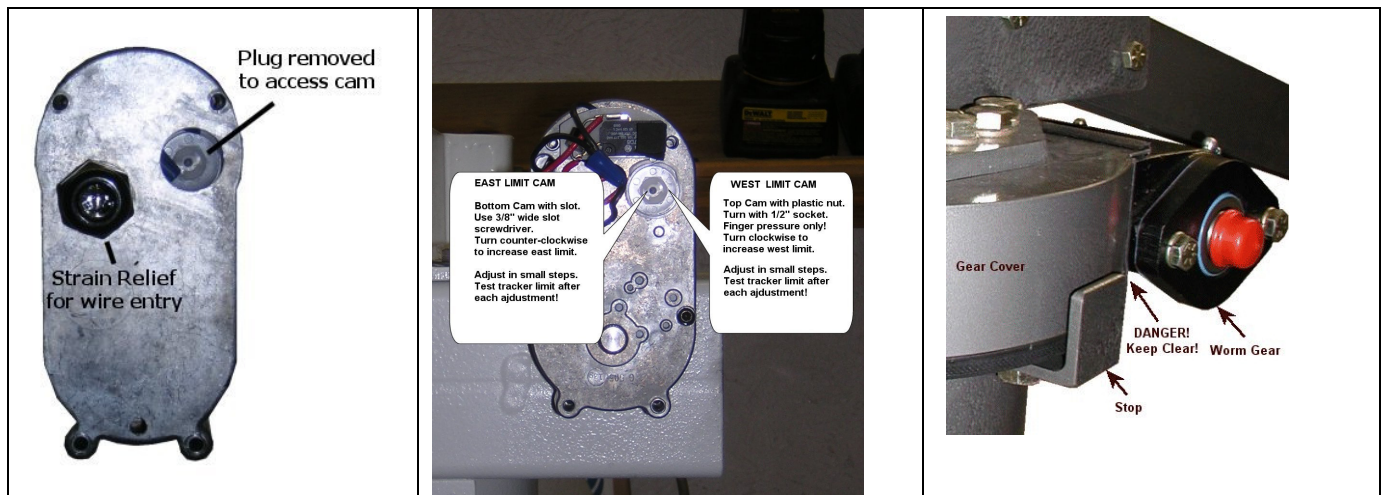

Do not exceed 135 degrees of rotation West of South or the Worm Gear Assembly will hit a welded safety stop. If you hit the stop the tracker motors will draw too much current and a self-resetting fuse in the controller will shut off the power to the azimuth motor. Turn the tracker controller off using Dip Switch #1, let the fuse cool for 3 minutes, adjust the West cam to reduce the west travel and flip Dip Switch #1 back to the normal operating position. Repeat this process if necessary.

**Always test the tracker range of motion after adjusting the cams! Then test it again!**



**FUNCTION:**

Most manual controls are installed on Wattsun Dual-Axis Trackers rather than on Single-Axis Units. The Manual Control Option allows the user to bypass automatic tracking and to move the tracker East, West, North, or South. The Manual Control Option is typically installed on your tracker before it leaves Array Technologies. However it is available as an upgrade kit that can be installed in the field.

The Manual Control Option requires that power be available to the Wattsun Tracker Controller. If the controller is connected to the main battery bank, then you can use the manual controls day or night. If you power the tracker controller from the array, then you will be limited to the daylight hours.

**HIGH WIND AREAS:**

If the tracker is run to a full North position, the array lays flat in a horizontal stow position. This is especially useful if you experience very strong winds or tropical storms and you want to reduce the wind loading on your tracker.

**HIGH SNOW AREAS:**

If the tracker is run to a full South position, the array elevates up to a 75-degree angle. This is useful for dumping any snow accumulation on the array.

**SWITCHES:**

Automatic / Manual - Flip Down for Auto Tracking or flip Up to enable Manual Tracking.

East / West - Hold left to track East or hold right to track West.

North / South - Hold up to track South (elevate) or hold down to track North (flatten).



12) PERIODIC MAINTENANCE

- ◆ Maintenance should be performed at least once a year. More often if your tracker is installed in severe weather areas.
- ◆ Inspect all the tracker hardware and the module bolts for tightness. Tighten all nuts and bolts that need it.
- ◆ Inspect all wires for abrasion and gently tug on them to make sure that they are secure.
- ◆ Each of the four grease zerks should receive 4-6 pumps of lithium-base general-purpose chassis grease from a grease gun.
- ◆ Elevation Actuator: Spray the inner tube (telescoping part) of the linear actuator with a lubricating rust inhibitor. (We use LPS-3)

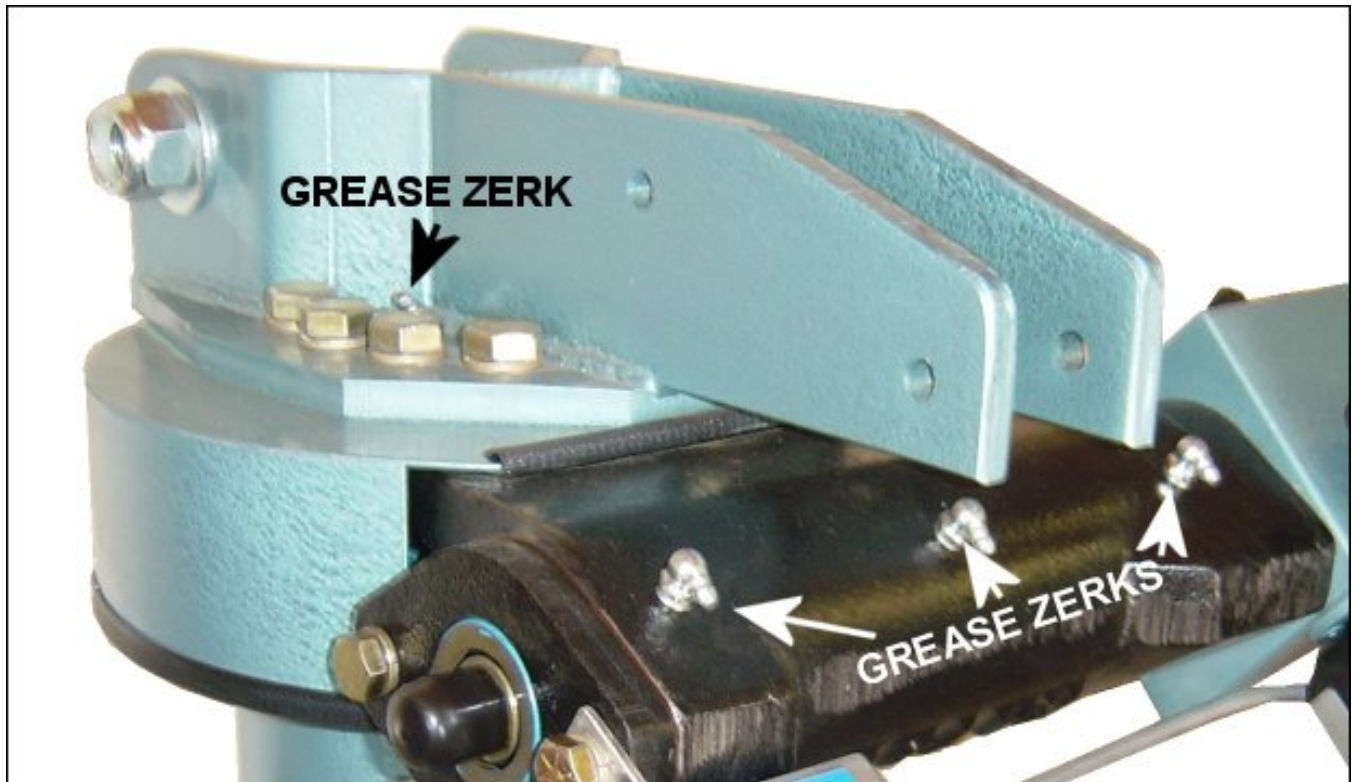

NOTE:

YOUR AZ-225 GEAR DIVE MAY HAVE THE 4<sup>th</sup> GREASE ZERK LOCATED ON THE BOTTOM OF THE GEAR HOUSING RATHER THAN THE TOP AS SHOWN IN THE PICTURE.

**WARNING!**

- The information provided here is a general guideline for grounding your Wattsun Solar Tracker.
- This information is not a substitute for following the National Electrical Code.
- You should hire a qualified Electrician, Electrical Contractor or Solar Professional to install and wire your Wattsun Solar Tracker.
- Array Technologies does not assume any liability for your failure to adhere to the NEC.
- Failure to ground your tracker may void your Wattsun Warranty and may result in damage to your Wattsun Solar Tracker Controller or motors.

**WATTSUN TRACKER RAILS ARE COMPATIBLE WITH WEEB 9.5 GROUNDING WASHERS.**

<http://www.we-llc.com/WEEB.html>

**GROUNDING REFERENCE:**

**John Wiles - Code Corner Columns available online at:**

<http://www.nmsu.edu/%7Etdi/Photovoltaics/Codes-Stds/codecorner.html>

## FIG 1: GROUNDING THE MODULES, TRACKER FRAME, DRIVE AND MOUNTING PIPE

The array equipment-grounding conductors, for the modules, tracker frame, drive and mounting-pipe, should terminate at one location—probably a grounding terminal strip in the junction/combiner box. Then, there should be a conductor from this point to the grounding electrode (ground rod).

The steps are:

- The frame of every module is interconnected with grounding wire.
- The module grounding wire ties into the tracker frame on the torque tube or struts.
- A flexible loop of grounding wire continues from the torque tube to the base of the drive.
- The ground wire continues to the mounting pipe or combiner box that is bonded to the pipe.
- The ground wire goes down the pole and is bonded to an 8-foot copper ground rod.
- The ground rod is set in the earth outside of the concrete foundation of the pipe.
- Do not rely on the mounting pipe to act as a ground rod.

**FIG 1**  
**Grounding a Wattsun Tracker**

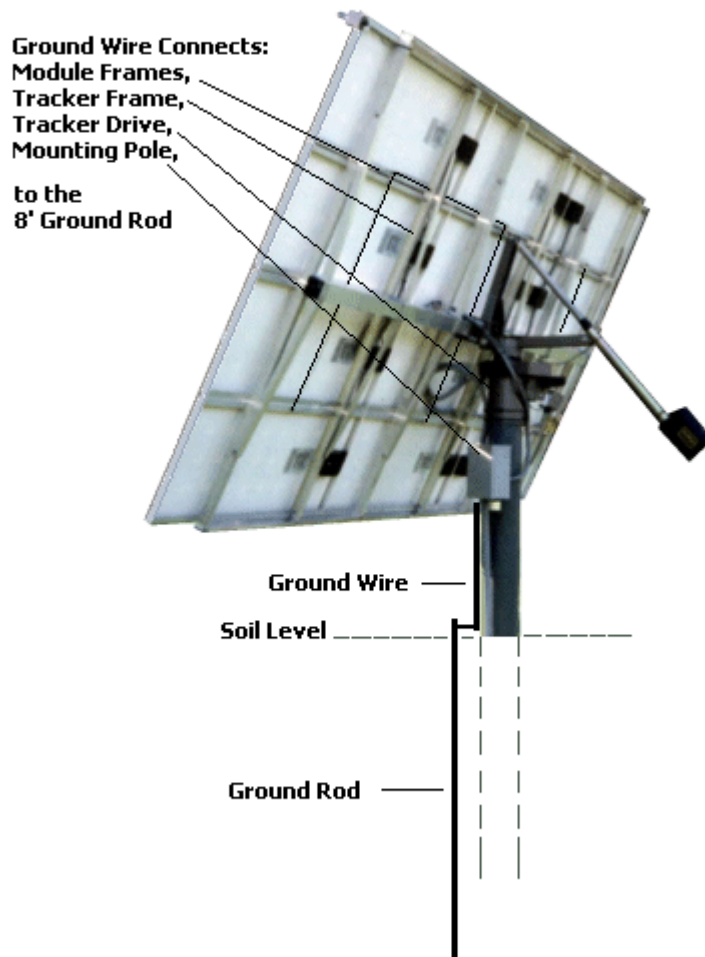

**FIG 2: TYPICAL GROUNDING OF A TRACKER TO THE BATTERY BANK/POWERCENTER.**

- The modules, Wattsun Tracker, and mounting pipe are grounded as shown in Figure 1.
- The normal, (primary bond) negative-to-ground bonding is required in the power center or ground-fault device.
- The negative current-carrying (PV Negative) conductor is bonded (connected) to the grounding system at the power center or charge controller.
- An equipment-grounding conductor is run from the PV array to the power center or charge controller.

**FIG 2**  
**Grounding a Wattsun Tracker that is located close to the battery bank.**

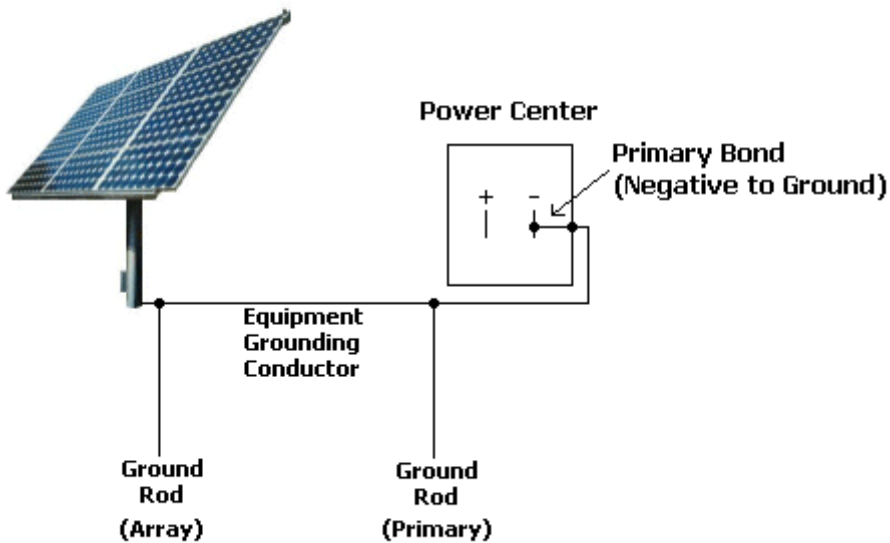

**WARNING!**

If you ground according to FIG 2, you must ground the PV Negative at the power center, not at the array. There can only be one ground for the current carrying conductor (PV Negative) in this situation.



**FIG 3: ALTERNATIVE GROUNDING FOR A TRACKER THAT IS DISTANT FROM THE BATTERY BANK/POWERCENTER.**

- The modules, Wattsun Tracker, and mounting pipe are grounded as shown in Figure 1.
- The PV array is ground mounted some distance (perhaps over 30 feet) away from other PV components (inverter, batteries, etc.). The distance is not specified in the NEC.
- There are no AC power circuits between the array and the bank/power center.
- There are no conductive paths (electrical or other) such as water pipes, metal fences, communication circuits, or telephone circuits between the array and the other structure.
- Bond the negative conductor (PV Negative) to the grounding system at both the array and at the inverter/battery/power center location.
- Do not run any equipment grounding conductors between the array and at the inverter/battery/power center location.
- Use ground rods at the array and at the inverter/battery/power center location.

**FIG 3  
Grounding a Wattsun Tracker that is over  
30 feet from the battery bank**

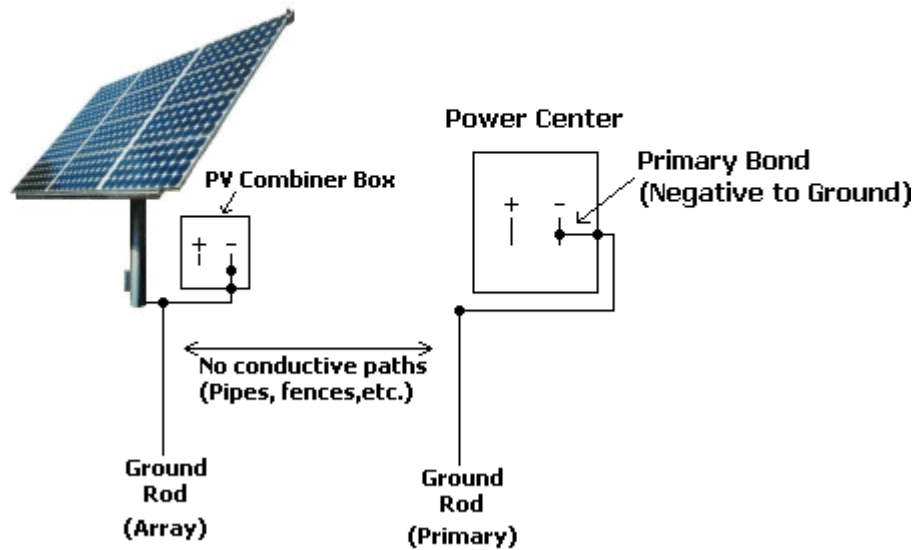

**WARNING!**

If you ground according to FIG 3, you must ground the PV Negative at both the array and at the powercenter. Do not run any equipment grounding conductors between the array and at the inverter/battery/power center location.

Array Technologies, Inc. warrants its Wattsun™ Solar Trackers to the original consumer purchaser that it will repair, or replace, at Array Technologies Inc.'s option, any Wattsun™ Tracker component that is determined to be defective in material or workmanship for the following terms:

**Two years from date of purchase on all components including tracker controller, frame, azimuth drive assembly, and actuator.**

**We do not warranty your foundation design or installation of the pipe mast.**

To be eligible for repair or replacement under this warranty, the part in question must be sent to Array Technologies, Inc. within the warranty period and the original consumer purchaser must comply with the following conditions:

- ◆ The tracker or component thereof must not have been modified or altered in any way by an unauthorized source.
- ◆ The tracker or component thereof must have been installed in accordance with the installation instructions including electrical connections of tracking controller.

**This limited warranty does not cover:**

- ◆ Damage due to wind speeds over 90 MPH.
- ◆ Accidental or intentional damage;
- ◆ Damage due to improper installation of the tracker;
- ◆ Misuse, abuse, corrosion, or neglect;
- ◆ Products impaired by severe conditions, such as excessive wind, ice, storms or other natural occurrences;
- ◆ Trackers used for purposes other than the intended use, including mounting modules or components which the tracker was not intended for;
- ◆ Trackers with more than the intended number and type of modules mounted on it;
- ◆ Damage due to improper packaging on return shipment.

**Any and all labor charges for troubleshooting, removal or replacement of tracker and/or components of the tracker are not covered by this warranty and will not be honored by Array Technologies, Inc.**

Return shipping is to be pre-paid by the original consumer

THIS WARRANTY IS EXPRESSLY IN LIEU OF ALL OTHER WARRANTIES OF ANY KIND, EXPRESSED OR IMPLIED, INCLUDING (WITHOUT LIMITATION) ANY IMPLIED WARRANTIES OF MERCHANTABILITY OR FITNESS FOR A PARTICULAR PURPOSE, AND OF ANY NONCONTRACTUAL LIABILITIES BASED UPON NEGLIGENCE OR STRICT LIABILITY. IN NO EVENT SHALL ARRAY TECHNOLOGIES, INC. BE LIABLE FOR INCIDENTAL OR CONSEQUENTIAL DAMAGES, INCLUDING (WITHOUT LIMITATIONS) ANY DAMAGE FOR PERSONAL INJURY OR PROPERTY DAMAGE OR OTHER PRODUCT LIABILITIES BASED UPON ALLEGED NEGLIGENCE OR BREACH OF EXPRESS OR IMPLIED WARRANTIES OR STRICT LIABILITY. ARRAY TECHNOLOGIES, INC. NEITHER ASSUMES NOR AUTHORIZES ANY OTHER PERSON TO ASSUME FOR IT ANY OTHER OBLIGATION IN CONNECTION WITH THE SALE OF ITS WATTSUN™ SOLAR TRACKERS.

THIS WARRANTY GIVES YOU SPECIFIC LEGAL RIGHTS, AND YOU ALSO MAY HAVE OTHER RIGHTS THAT MAY VARY FROM STATE TO STATE. SOME STATES DO NOT ALLOW LIMITATIONS ON HOW LONG AN IMPLIED WARRANTY WILL LAST OR THE EXCLUSION OR LIMITATION OF INCIDENTAL OR CONSEQUENTIAL DAMAGES, SO THE ABOVE LIMITATIONS OR EXCLUSIONS MAY NOT APPLY TO YOU.

**Array Technologies, Inc.  
3312 Stanford NE  
Albuquerque, NM 87107**

**Tel: 505-881-7567  
Fax: 505-881-7572  
URL: [www.wattsun.com](http://www.wattsun.com)**