

Advancing the Future of Rooftop Solar



Quick Mount PV[®]
RESPECT THE ROOF



Advancing the Future of Rooftop Solar

Quick Mount PV was founded on the principle that the mounting system is just as critical to the success of a solar installation as the modules and inverters. Since 2006, Quick Mount PV has advanced rooftop solar through its innovative, high-quality waterproof mounting systems. With industry-leading R&D, engineering, product testing and ISO 9001:2008 certified manufacturing in California, Quick Mount PV is committed to producing the industry's most advanced solar mounting systems.

The company's first innovation, the QBlock® Elevated Water Seal, revolutionized rooftop mounting with its unprecedented waterproofing technology and its simple, labor-saving installation. The patented QBlock technology is at the core of Quick Mount PV's best-selling line of mounts.

Other innovations include the QBase® technology, a base-and-post mounting system with unrivaled strength to support higher standoff posts for a variety of roof types and conditions.

QHook®, Quick Mount PV's tile hook technology, eliminates the need for tile penetration and combines superior waterproofing, strength and a high degree of adjustability for fast, simple installation.

Rail-free mounting systems can significantly lower the expense of material handling and reduce installation time on the roof. That's why Quick Mount PV developed Quick Rack™, a patented rail-free mounting system for composition/asphalt shingle roofs, using QRack® technology to help reduce the cost of rooftop installations.

Quick Mount PV products are approved by leading roofing manufacturers, meet or exceed roofing best practices, and are 100 percent compliant with the International Building Code. All QBlock, QBase and QHook products carry an industry-best 20-year limited product warranty.



Quick Mount PV is the solar industry's leading manufacturer of roof mounting products and is dedicated to ongoing innovation and uncompromising quality.

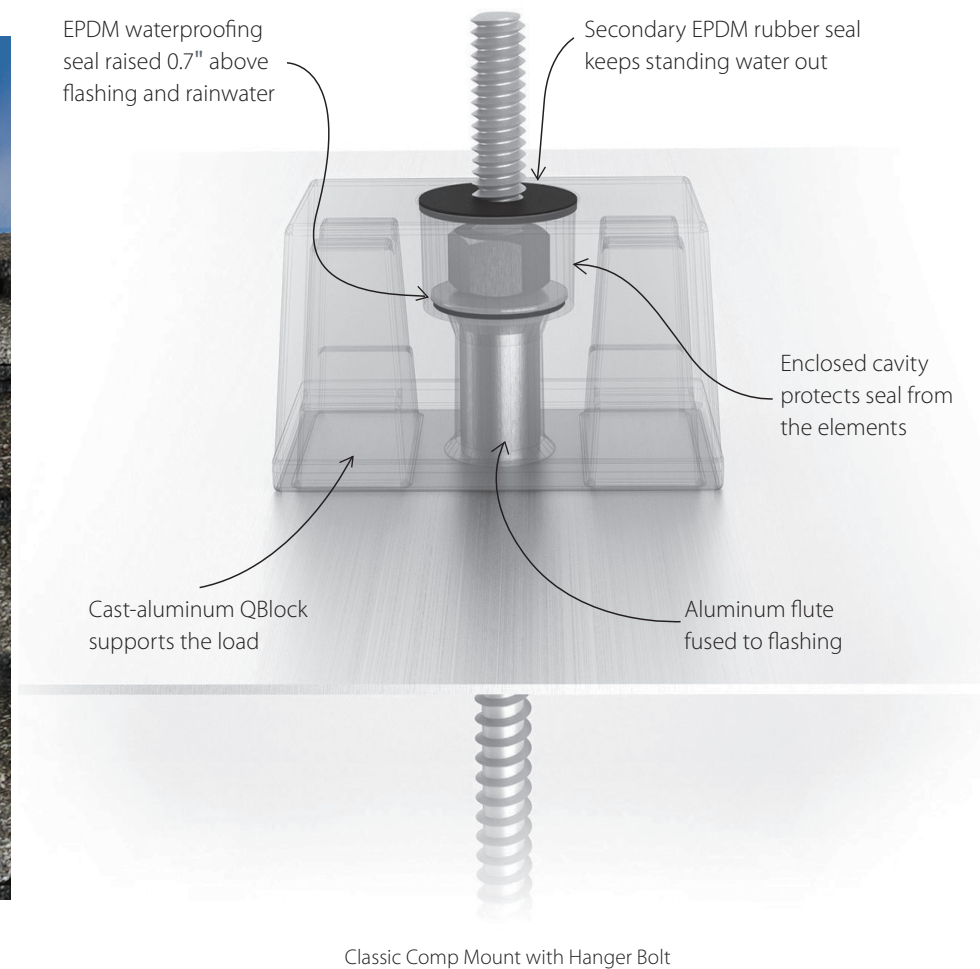
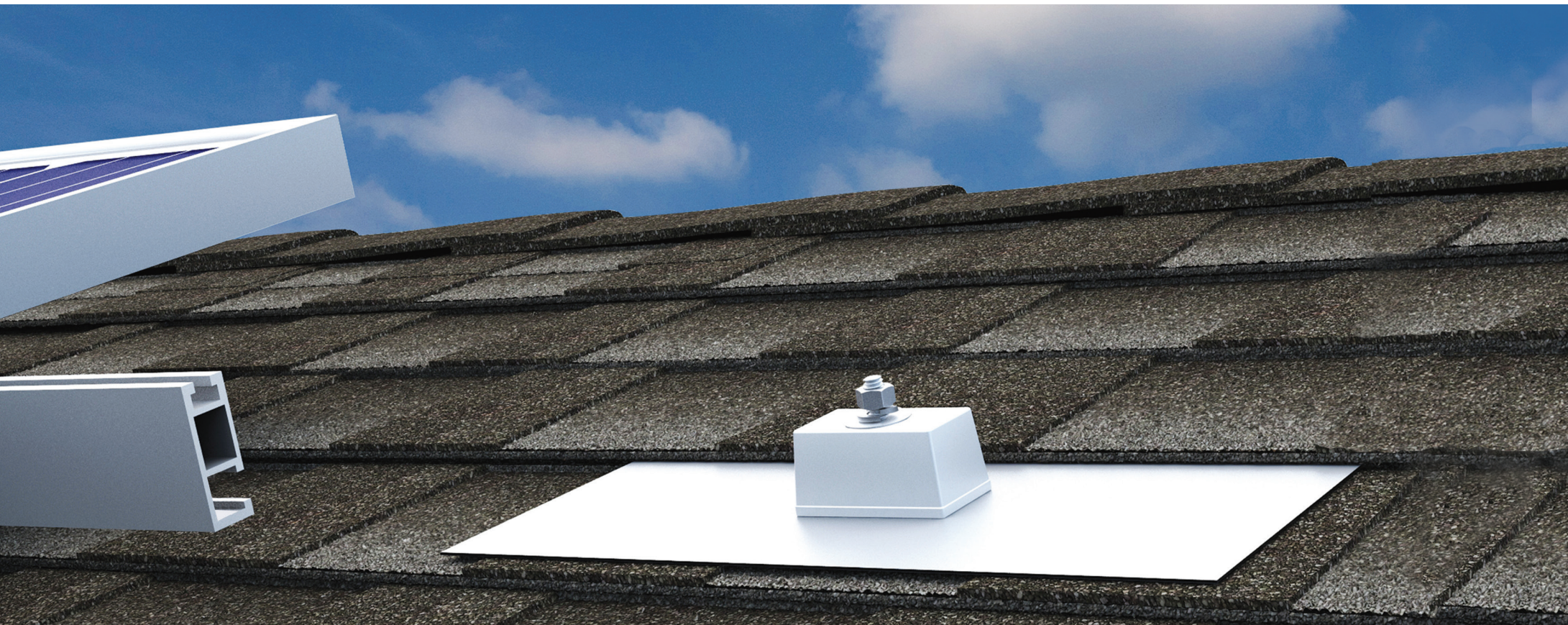

Quick Mount PV revolutionized rooftop solar mounting when it introduced its flagship technology, the patented QBlock Elevated Water Seal, which has since been proven in millions of installations.

QBlock Innovation

Other roof mounts seal the bolt holes in the flashing with a rubber seal mounted directly against the flashing at the water level. A leak is almost inevitable as the seal slowly deteriorates in the harsh roofing environment. Quick Mount PV's patented QBlock uses an aluminum flute to elevate the EPDM rubber seal above the flashing and out of harm's way.

The cast-aluminum QBlock completely encloses the rubber seal, shielding the sealing area from the ravages of rain, ice and UV exposure, and minimizing stresses on the rubber seal caused by thermal- and wind-induced movement of the solar array. A secondary rubber seal provides a final measure of safety.

Technology Benefits

- Preserves waterproofing for the life of the roof and solar array
- Approved by leading roofing manufacturers, won't void roofing warranties
- ICC-ES certified for strength and waterproofing
- Meets or exceeds roofing industry best practices
- 100% IBC compliant

QBlock Products

Classic Composition Mount Series

The flagship product using patented QBlock technology with .05" thick, 12 x 12-inch flashing. Available with hanger or lag bolt for fast, simple installation.



E-Mount Series

QBlock technology with .04" thick, 9 x 12-inch flashing. Available with hanger or lag bolt for fast, simple installation.

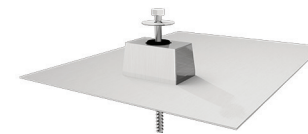

Classic Shake Mount

Specially engineered with 18 x 18-inch flashing for installing solar onto cedar shake roofs.



QBlock® for Tile Technology OPTIMAL WATERPROOFING & SIMPLE INSTALLATION

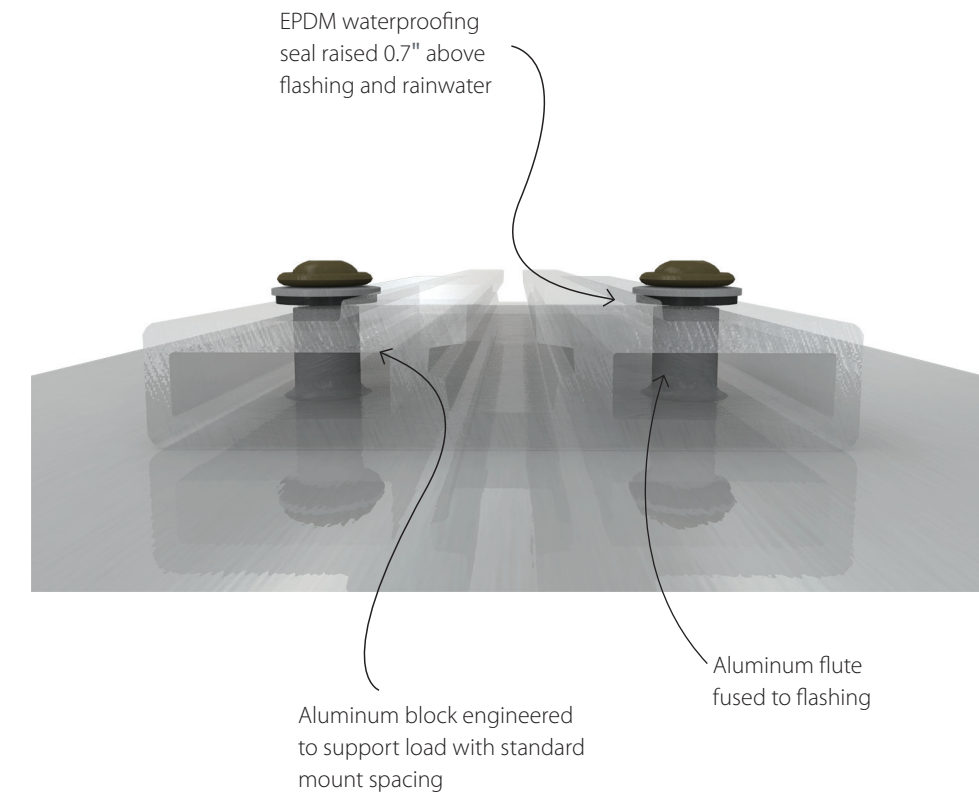

The Tile Replacement Mount features QBlock patented Elevated Water Seal technology for optimal waterproofing, without messy tile grinding or cutting.

QBlock for Tile Innovation

Fully engineered universal base mount with integrated flashing is adjustable and can be oriented to the left or right for proper rafter location. The base mount also features an innovative track that positions the mounting post for optimal location. Preformed flashing and Elevated Water Seal Technology provides code-compliant deck-level waterproofing.

Technology Benefits

- Works with Flat, S and W-shaped tiles and all standard rail-based racking systems
- Enables fast, clean installation without cutting or grinding tiles
- Features QBlock Elevated Water Seal Technology
- Flashed at both the deck and tile levels for code compliance
- Meets or exceeds roofing industry best practices
- 100% IBC compliant

QBlock for Tile Products

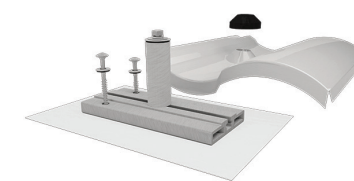

Tile Replacement Mount for S-shaped curved tile profiles

Universal base mount with integrated sub-flashing, 3.25" post and preformed aluminum flashing replaces S-shaped tile.

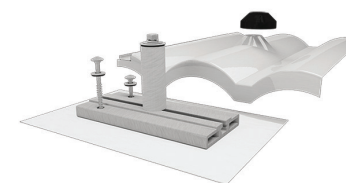

Tile Replacement Mount for W-shaped curved tile profiles

Universal base mount with integrated sub-flashing, 4" post and preformed aluminum flashing replaces W-shaped tile.

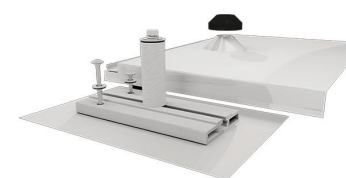

Tile Replacement Mount for flat tile profiles

Universal base mount with integrated sub-flashing, 3.25" post and preformed aluminum flashing replaces flat tile.

QRack® Technology INNOVATIVE RAIL-FREE MOUNTING

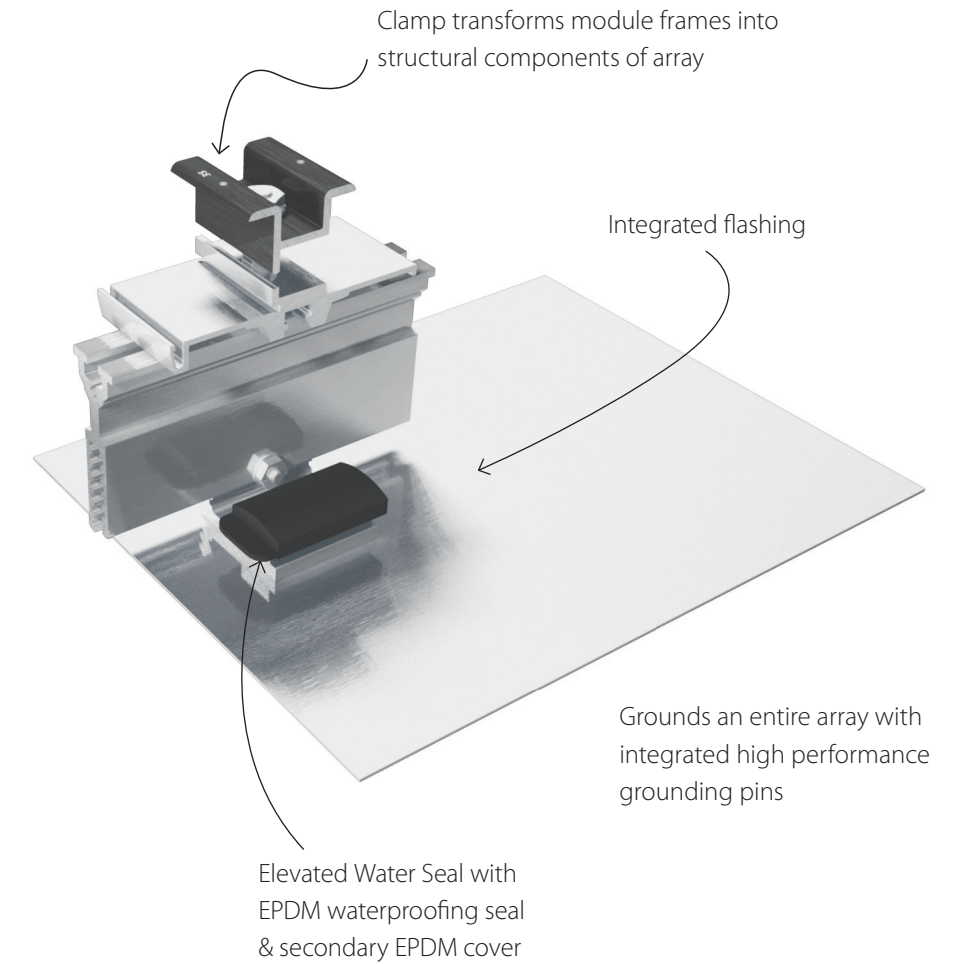
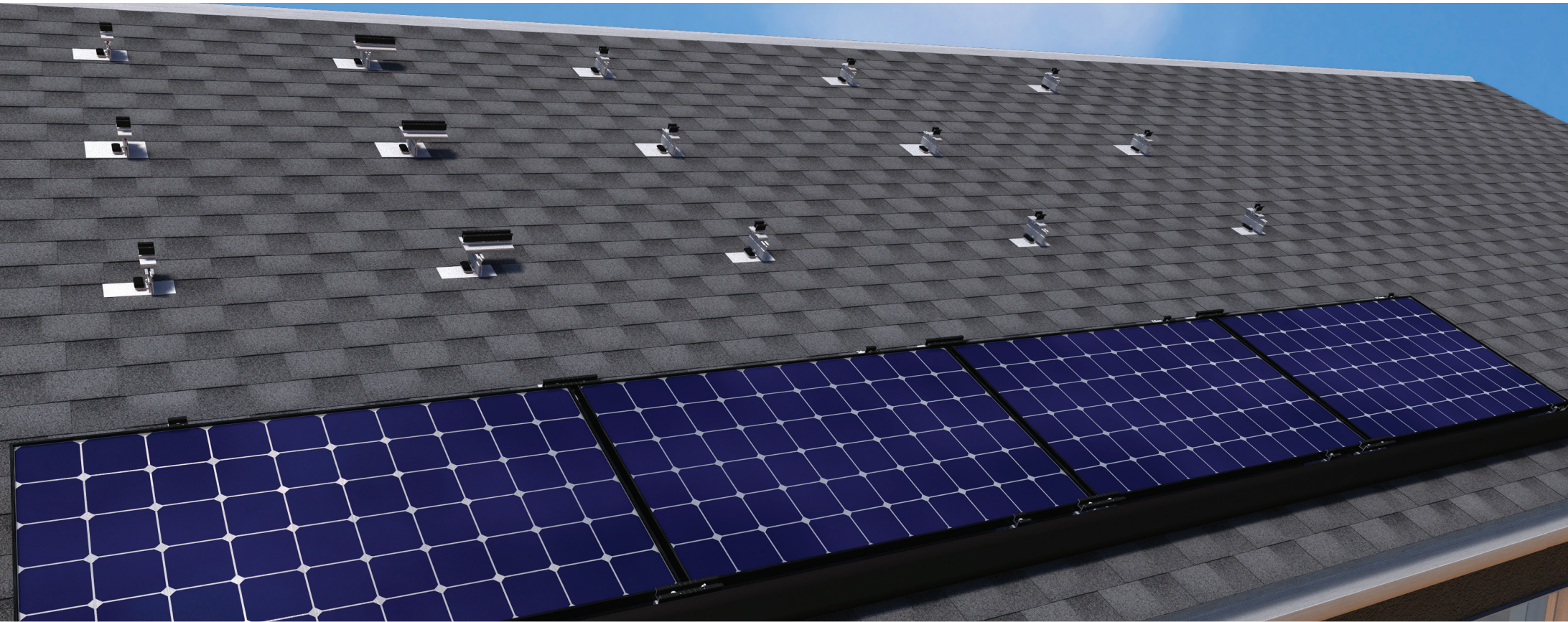

Designed and engineered for fast and cost effective rooftop installation, QRack is the key technology in Quick Rack, a patented rail-free mounting system for composition/ asphalt shingle roofs.

QRack Innovation

QRack technology balances strength, flexibility and simplicity. Quick Rack features a base mount with integrated flashing and Elevated Water Seal technology, a clamp that transforms the module frames into structural components of the solar array, and a single grounding lug to ground the entire array. An optional panel skirt provides a clean, elegant aesthetic.

Technology Benefits

- Superior waterproofing with patented Elevated Water Seal technology
- Works with standard module frames
- Compatible with micro-inverters, optimizers and standard inverters
- Grounds entire array with single grounding lug and integrated grounding pins
- Requires only half-inch socket wrench for installation
- Comes with easy-to-use Quick Mount Designer software



Quick Rack Components

Base Mount

Integrated flashing featuring QBlock Elevated Water Seal technology



Panel Clamp

Available in 2" and 8" sizes for both mid- and end-clamping. Works with standard module frames.

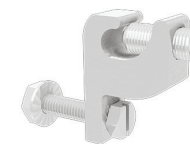

Grounding Lug

Ground entire array with single grounding lug

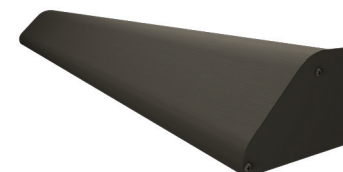

Skirt

Optional panel skirt snaps into place to create a clean, streamlined finish for the solar array

QBase® Technology A SUPERIOR BASE-AND-POST MOUNTING SYSTEM

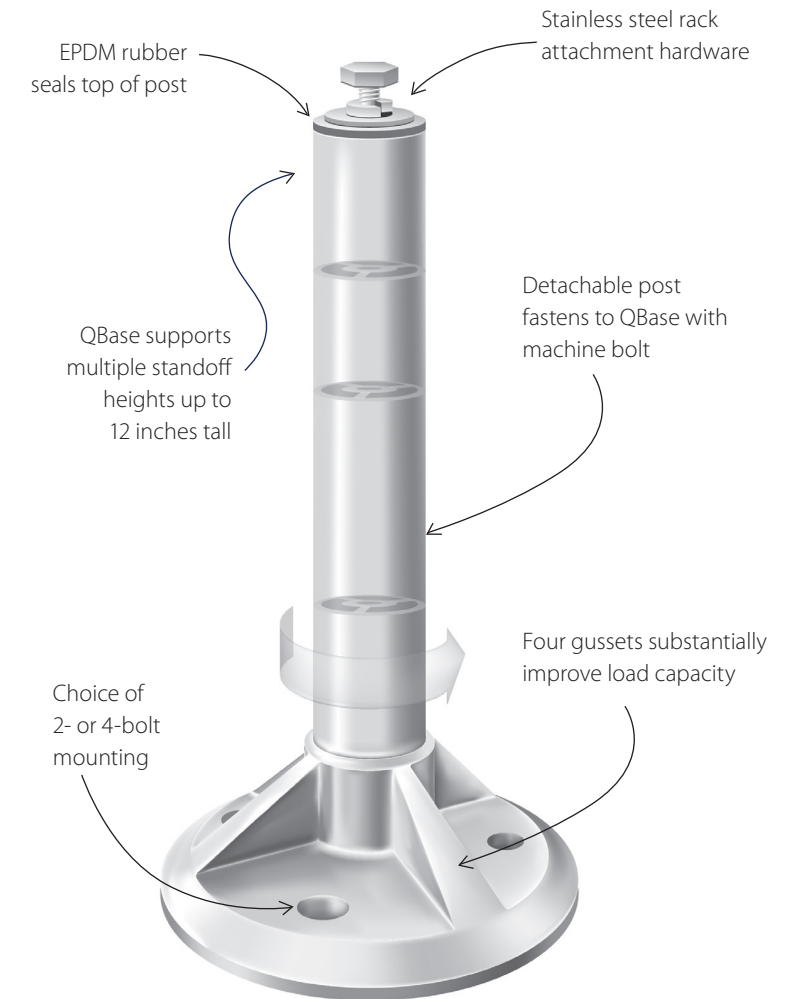

Quick Mount PV developed QBase to provide a strong and versatile mounting solution for installations with high standoffs.

QBase Innovation

Typical base-and-post mounting systems lose structural integrity when standoffs exceed a few inches. The QBase has a super-strong cast aluminum foundation with four gussets to support standoff posts from 3.75 to 12 inches. The single base for all post heights reduces the number of components needed for a wide variety of roof types and installations.

QBase Applications

When standoffs get higher than several inches, such as with installations on curved tile and commercial built-up or insulated low slope roofs, QBase's superior strength and proven waterproofing provide decades-long confidence.

Technology Benefits

- Supports standoffs up to 12 inches
- Exceptional shear and pullout strength
- Adaptable to asphalt shingle, tile, shake, slate, metal shingle, and low slope roofs
- Meets or exceeds roofing industry best practices
- 100% IBC compliant

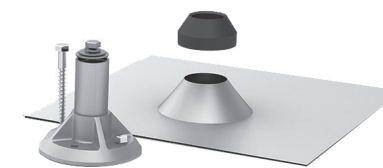

QBase Products

QBase Composition Mount

Strong mounting platform for asphalt shingle roofs, particularly well-suited to installing solar with re-roofing or new roof construction.

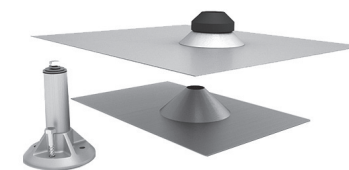

QBase Universal Tile Mount

Heavy-duty tile mount with both deck- and tile-level flashing, works on curved and flat tile roofs.

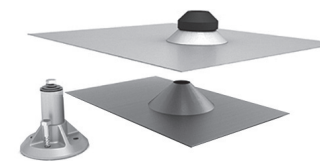

QBase Standard Flat Tile Mount

Same technology as the QBase Universal Tile Mount but with a shorter post for a lower profile.



QBase Low Slope Mount

The strongest mechanical roof attachment for low slope commercial roofs, provides a reliable alternative to problematic ballasted mounting.

QHook® Technology OPTIMIZING THE TILE HOOK

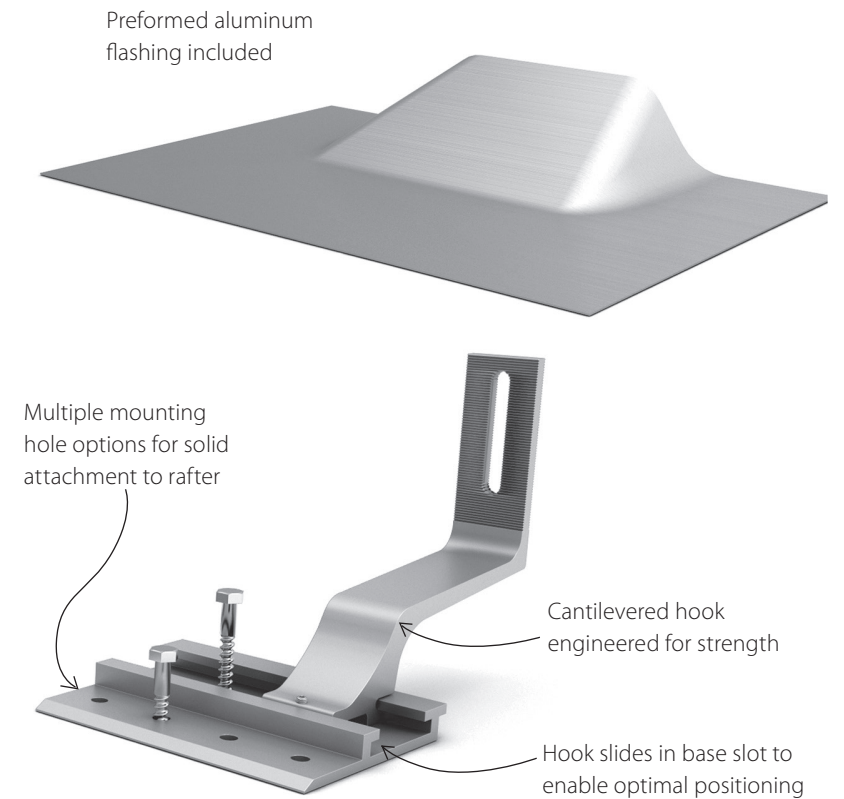

Engineered for strength, QHook enables simple solar installations on tile roofs. Form-fitting flashing and a sliding base-hook interface allow fast, economical installation without penetrating or replacing tiles.

QHook Innovation

A unique sliding hook-and-base track enables several inches of side-to-side adjustment to position the hook to the optimal location between the tiles. The base has multiple sets of mounting holes for even more flexibility. Preformed flashing provides code-compliant deck-level waterproofing.

QHook Applications

QHook enables streamlined tile roof installations with no hole cutting, less dust, and fewer broken tiles.

Technology Benefits

- Multiple height options for use with a variety of tiles
- Designed for use with side-mounted or bottom-mounted rails
- Enables fast, cost-effective installation
- Deck-level flashing provides code-required waterproofing and an attractive appearance
- Meets or exceeds roofing industry best practices
- 100% IBC compliant

QHook Products

Quick Hook® SS/LS – For Side Mount Rails

Standard height & low height hooks for side-mounted rails. Preformed flashing and adjustable hook for simple, clean installation.

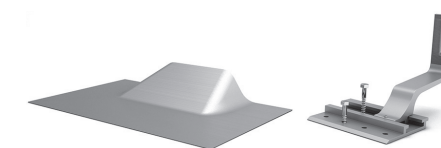

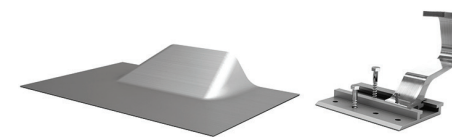

Quick Hook® SB/LB – For Bottom Mount Rails

Standard height & low height hooks for bottom-mounted rails. Preformed flashing and adjustable hook for simple, clean installation.



Product Overview by Roof Type

Mounts for Composition/Asphalt Shingle Roofs

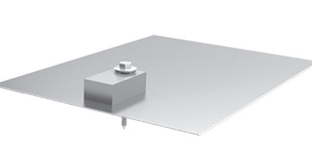
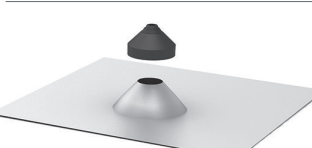
Product	Technology	Flashing	Available Finishes	Warranty
 <p>Classic Comp Series QMSE - hanger bolt QMSE-LAG - lag bolt QMSE-EHB - extended hanger</p>	QBlock®	12"x12" aluminum	Mill Bronze Anodized	20 Years
 <p>E-Mount Series QMSE - hanger bolt QMSE-LAG - lag bolt QMSE-EHB - extended hanger</p>	QBlock®	9"x12" aluminum	Mill Bronze Anodized	20 Years
 <p>QBase Comp QMNC</p>	QBase®	12"x12" spun aluminum cone	Mill Bronze Anodized	20 Years
 <p>Classic Conduit QMCC</p>	QBlock®	9"x12" aluminum	Mill Bronze Anodized	20 Years
 <p>Conduit Penetration Flashing QMPCP</p>	standard	12"x12" spun aluminum cone	Mill	20 Years

Mounts for Low Slope Roofs

Product	Technology	Flashing	Available Finishes	Warranty
 <p>QBase Low Slope QMLSH</p>	QBase®	varies aluminum flashing sold separately	Mill Bronze Anodized	20 Years

All hardware included. All exposed hardware stainless steel.

Mounts available for shake & slate roofs. See website for more info.

Mounts for Tile Roofs

Product	Technology	Flashing	Available Finishes	Warranty
 <p>Tile Replacement Mount - S-Tile QMTR-BM & QMTR-S3.25 <i>Base mount sold separately from flashing & post.</i></p>	QBlock®	double flashed	Mill	20 Years
 <p>Tile Replacement Mount - Flat Tile QMTR-BM & QMTR-F3.25 <i>Base mount sold separately from flashing & post.</i></p>	QBlock®	double flashed	Mill	20 Years
 <p>Tile Replacement Mount - W-Tile QMTR-BM & QMTR-W4 <i>Base mount sold separately from flashing & post.</i></p>	QBlock®	double flashed	Mill	20 Years
 <p>Quick Hook® SS/LS For Side Mount Rails QMSS/QMLS</p>	QHook®	9"x14" preformed aluminum	Mill	20 Years
 <p>Quick Hook® SB/LB For Bottom Mount Rails QMHSB/QMHLB</p>	QHook®	9"x14" preformed aluminum	Mill	20 Years
 <p>QBase Universal Tile QMUTM</p>	QBase®	double flashed	Mill Bronze Anodized	20 Years
 <p>QBase Standard Flat Tile QMSFT</p>	QBase®	double flashed	Mill Bronze Anodized	20 Years
 <p>Conduit Mount for Tile QMCMT</p>	standard	---	Mill	20 Years
 <p>Tile Conduit Penetration Flashing QMCPPT</p>	standard	double flashed	Mill Bronze Anodized	20 Years



Training & Support

Successful solar installations depend on outstanding training and technical support. Quick Mount PV is widely recognized as the pioneer and leading educator of roofing best practices in the solar industry.

Industry Best Training

Quick Mount PV is committed to helping the industry increase the longevity, reliability and value of rooftop solar PV installations with superior training and support. The company tailors training programs for each of the trades involved in the design, sales, and installation of rooftop solar energy systems.

Thousands of solar professionals throughout North America have attended training workshops, classroom instruction, webinars, and industry conference presentations by Quick Mount PV.

Regularly scheduled webinars and in-person trainings cover roofing best practices for a variety of roof types, the latest roofing codes for solar, and many other topics.

The company headquarters features a state-of-the-art, solar rooftop training center complete with hands-on demonstration roofs used to present live, in-person workshops, often held in conjunction with technical product training by industry partners.

Live tech support, a comprehensive library of instructional videos, and a wealth of in-depth technical information on the company website provide Quick Mount PV installers with the highest level of support in the solar industry.

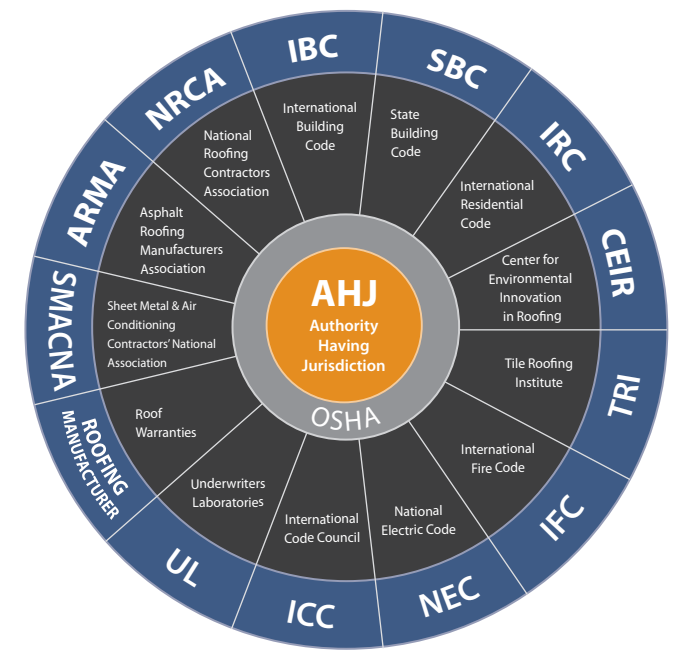

Quick Mount PV helps installers navigate the often-complex interrelationships of codes, standards and best practices.



The company also provides on-site instruction for leading solar training organizations such as Solar Energy International.

WHAT MAKES QUICK MOUNT PV THE INDUSTRY STANDARD?

Our Customers Say it Best...



When I'm punching dozens of holes to mount a solar array, I need to be certain there are no points of failure. Only Quick Mount PV gives me that assurance.

Tony Diaz, Century Roof & Solar



With our severe Rocky Mountain winters, only Quick Mount PV delivers the installation speed and absolute confidence we need.

Will Serene, Independent Power Systems



I learned the hard way at a previous employer. Now I trust every job I can to Quick Mount PV.

Justin McComas, Baker Electric Solar



Quick Rack is truly the next generation in rail-free mounting systems, enabling us to deliver aesthetically pleasing rooftop solar that differentiates us from our competition.

Glen Koedding, Green Sun Energy Services, LLC



I've tried a lot of attachment options, but here in the rainy Pacific Northwest, there is only one product I can trust on my customers' homes. Once we started using Quick Mounts we never stopped.

Sarah Freel, Synchro Solar



Quick Mount PV delivers not just the best product, but also the best training, technical, and sales support. No doubt about it - Quick Mount PV helps us sell more solar.

Dean Rafaat, Wired into the Future Solar



Thanks to Quick Mount PV, the alliance between roofing and solar is stronger than ever.

Chip Upshaw, Fidelity Roof

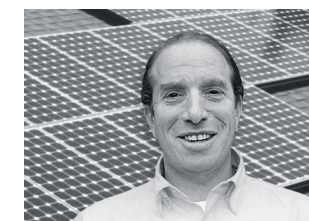

Quick Mounts are better quality, more cost effective, and easier to install than any brand we've used.

Darren Malvin, American Solar



Photo credits: inside front cover - Creative Energies; page 11- Solar Energy International

Printed on recycled paper using vegetable-based inks.

©2016 by Quick Mount PV. All rights reserved.



2700 Mitchell Drive
Walnut Creek, CA 94598
www.quickmountpv.com
925-478-8269



Made in USA

CB Jun 2016