

Dimensions®

DC to AC POWER INVERTERS

Pure Sine Wave Output

OWNER'S MANUAL



**MODELS:
12/800N
12/1200N
12/1500N**

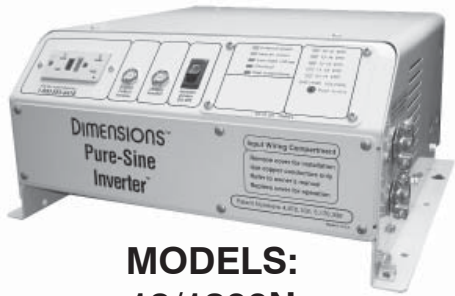

**MODELS:
12/1800N
12/2400N
12/3000N
12/3600N**



Sensata
Technologies

TABLE OF CONTENTS

SAFETY INSTRUCTIONS	2
Inverter Safety Instructions	2
Battery Safety Instructions	3
THEORY OF OPERATION.....	3
Inverter Power Mode.....	3
NOMENCLATURE	4
MOUNTING THE INVERTER.....	4
Installation Tools.....	4
Inverter Mounting Recommendations	4
DC WIRING GAUGE & FUSING.....	5
Inverter Cable.....	5
Cable Recommendations	5
REMOTE ON/OFF SWITCH.....	5
HARDWIRE OUTPUT	6
WIRING DIAGRAMS	6
Typical Wiring Diagram for 12/800N, 12/1200N & 12/1500N	6
Typical Wiring Diagram for 12/8000N, 12/2400N, 12/3000N, & 12/3600N	7
Typical DC Cable Connections for 12/800N, 12/1200N & 12/1500N.....	8
Typical DC Cable Connections for 12/1800N, 12/2400N, 12/3000N, & 12/3600N	9
INVERTER TROUBLESHOOTING GUIDE	10
Troubleshooting Steps.....	11
SPECIFICATIONS	12
OTHER DESIGN FEATURES	12
UNIT PROTECTION	12
BATTERY PROTECTION.....	12
LIMITED WARRANTY TERMS & CONDITIONS.....	13

SAFETY INSTRUCTIONS

IMPORTANT: Read this manual before installation, it contains important safety, installation, and operating instructions. Save this manual and keep it in a safe place.



(Except 12/1500N -
NOT UL Listed)

NOTE: This product is Listed to applicable UL Standards and requirements by Underwriters Laboratories Inc., File E100666.

Sensata Technologies is an ISO 9001:2008 Registered Company.

Sensata uses the following special notices to provide warning of possible safety related problems which could cause serious injury and to provide information to help prevent damage to equipment.

- ▲ **DANGER** indicates an imminently hazardous situation which, if not avoided will result in death or serious injury.
- ▲ **WARNING** indicates a potentially hazardous situation which, if not avoided, could result in death or serious injury.
- ▲ **CAUTION** indicates a potentially hazardous situation which, if not avoided, may result in minor or moderate injury.







CAUTION used without the safety alert symbol indicates a potentially hazardous situation which, if not avoided, may result in property damage.

NOTE is used to notify of installation, operation, or maintenance information that is important but not hazard related.

Inverter Safety Instructions:

- ▲ **WARNING:** Power Inverters produce hazardous voltages. To avoid risk of harm or fire, the unit must be properly installed.
- ▲ **WARNING:** There are no user serviceable parts inside, do not remove the cover.
- ▲ **WARNING:** Power Inverters should not be mounted in a location that may be exposed to rain or spray.
- ▲ **WARNING:** Power Inverters should not be installed in a zero clearance enclosure.
- ▲ **WARNING:** Damage to the Power Inverter will occur if correct polarity is not observed when installing the inverter's DC input cables.
- ▲ **WARNING:** Damage to the Power Inverter will occur if an external AC power source is applied to the inverter's AC hardwire output.
- ▲ **WARNING:** Power Inverters contain a circuit breaker and capacitor that may produce a spark. Do not mount in a confined battery or gas compartment.
- ▲ **WARNING:** Be sure the Power Inverter is turned OFF during installation.

Battery Safety Information:

-  **WARNING:** Working in the vicinity of lead-acid batteries is dangerous. There is a risk of acid exposure.
-  **WARNING:** Batteries generate explosive gases during operation.
-  **WARNING:** There is risk of high current discharge from shorting a battery that can cause fire and explosion. Use insulated tools during installation.
-  **WARNING:** Remove all rings, watches, jewelry or other conductive items before working near the batteries.
-  **WARNING:** Inspect the batteries once a year for cracks, leaks or swelling.
-  **WARNING:** Dispose of the batteries according to local regulations. Do not incinerate batteries; risk of explosion exists.

THEORY OF OPERATION

The “Local On/Off Switch” located on front, or the “Remote On/Off Switch” if used controls the inverter. Both the Local and “Remote On/Off” switches are configured in series. To control the inverter remotely set the “Local On/Off switch” to ON.

The inverter will operate in “inverter mode” only.

Inverter Power Mode

When the inverter is in “Inverter Power” mode, the green LED “Inverter” will come on. The AC power produced by the inverter comes from the energy stored in the battery bank through a sophisticated electronic inversion process. A transformer, a Metal Oxide Silicon Field Effect Transistors (MOSFET), a filter capacitor and a waveform stabilizer circuit are used to generate clean useful AC power.

Note: The signal output waveform produced by the inverter when in “inverter mode” is pure sinusoidal. It has a total harmonic distortion of less than 5%.

NOMENCLATURE

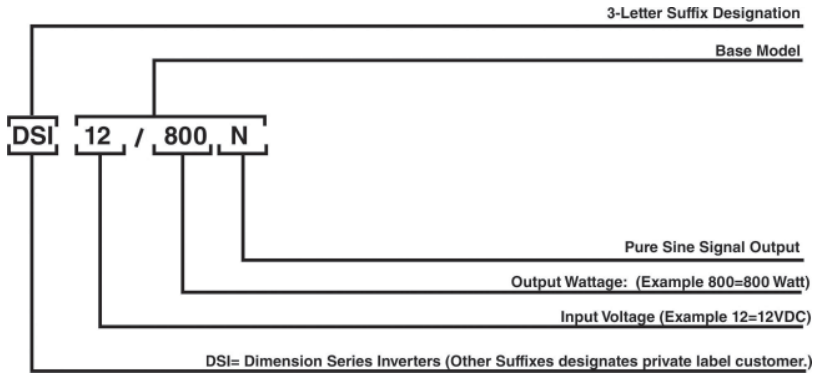

MOUNTING THE INVERTER

Installation Tools

The following tools are required for inverter installation: Crimper, Cable Ties, Cutter, Drill, #2 Phillips Screw Driver, Tape Measure, Wire Cutters, and Wire Strippers.

Inverter Mounting Recommendations

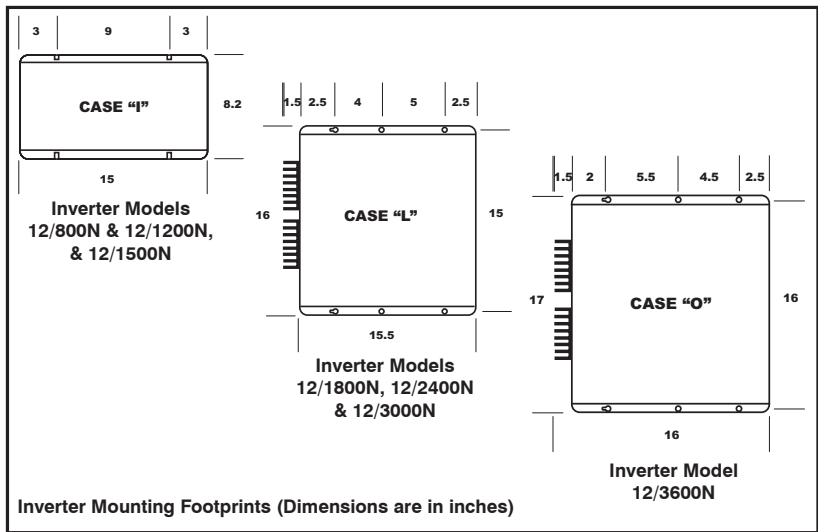

NOTE: The inverter mounting location should provide adequate ventilation and clearance to maintain room temperature during operation. A minimum of 1/2 inch of clearance is required on all sides.

1. Locate a suitable vertical or horizontal mounting surface as close to the batteries as possible without being in the same airtight compartment.
2. If mounting the inverter on a vertical surface, the front control panel should be pointing down whenever possible.
3. Locate the mounting holes on the chassis flanges and fasten them using the 1/4 inch diameter screws to secure the inverter.

DC WIRE GAUGE, FUSING & BATTERIES

Inverter Cable

An “Inverter Cable” kit (positive cable, negative cable, and proper fuse) is required to connect the inverter to a battery pack. An 8-gauge cable is also required to connect the inverter’s bonding lug to ground.

The inverter cable length and the size of the inverter will determine the cable gauge and the size fuse to use. The maximum inverter cable recommended is 20-ft; it must be fused within 18-in from the positive (+) terminal of the battery.

Cable Recommendations

1. Use stranded copper cable.
2. Use SGX cross-linked polyurethane insulation type that complies with the high temperature insulation requirements (125° C) of SAE J-1127 and vehicle manufacturer requirements.
3. Cable gauge recommendations are minimum. For higher than normal temperature applications or large motor loads, and other applications with high surge currents, use cable gauge 1 to 2 sizes larger than recommended in Table 1.
4. Keep the cable lengths between the battery and inverter as short as possible.
5. UL requires that a line fuse be installed within 18 inches of the battery. Use only Bussmann ANN type fuses to 500A and Bussmann ANL for 600A.

Cross reference the inverter model, and the estimated cable length in Table 1 to determine the proper cable gauge and fuse size. The Inverter Cable kit may be purchased directly from Sensata Technologies.

Table 1: Cable and Fusing Guide at 5% Voltage Drop at Full Output

Inverter Model	Full Load (Amps DC)	Fuse Size	Inverter to Battery Estimated Cable Length in Feet		
			1 ft. to 10 ft.	11 ft. to 15 ft.	16 ft. to 20 ft
12/800N	80	150A	4-gauge	4-gauge	2-gauge
12/1200N	120	200A	4-gauge	2-gauge	1-gauge
12/1500N	150	200A	2-gauge	1-gauge	1/0-gauge
12/1800N	180	300A	2-gauge	1/0-gauge	2/0-gauge
12/2400N	240	400A	1/0-gauge	2/0-gauge	4/0-gauge
12/3000N	300	500A	2/0-gauge	4/0-gauge	4/0-gauge
12/3600N	360	600A	4/0-gauge	4/0-gauge	NR

*Proper cable gauge must be used to prevent excessive voltage drop at the inverter DC input
 *Some motor starting may require the use of the next larger size cable

Recommended Battery Sizes & Quantities @ full hp rating

12/1800N	12/2400N	12/3000N	12/3600N
1 Deep Cycle	2-8D	2-8D	1 or 2-8D

REMOTE “ON/OFF” SWITCH

An optional customer supplied remote “On/Off” switch can be connected to the remote On/Off switch hookup lead extending from the inverter (violet wire). Use an 18-gauge cable, single pole single throw switch, and a 5-amp in-line fuse installed within 10 inches from the positive (+) terminal of the battery.

HARDWARE OUTPUT

The hardwire A.C. output is not ground fault interrupt, (GFCI) protected unless the inverter has option "A". GFCI outlets should be installed at all appropriate locations per NEC 551. The GFCI outlet should be Leviton Type 7899, 20Amp., 125VAC.

WIRING DIAGRAMS

Typical Wiring Diagram for 12/800N, 12/1200N & 1500N

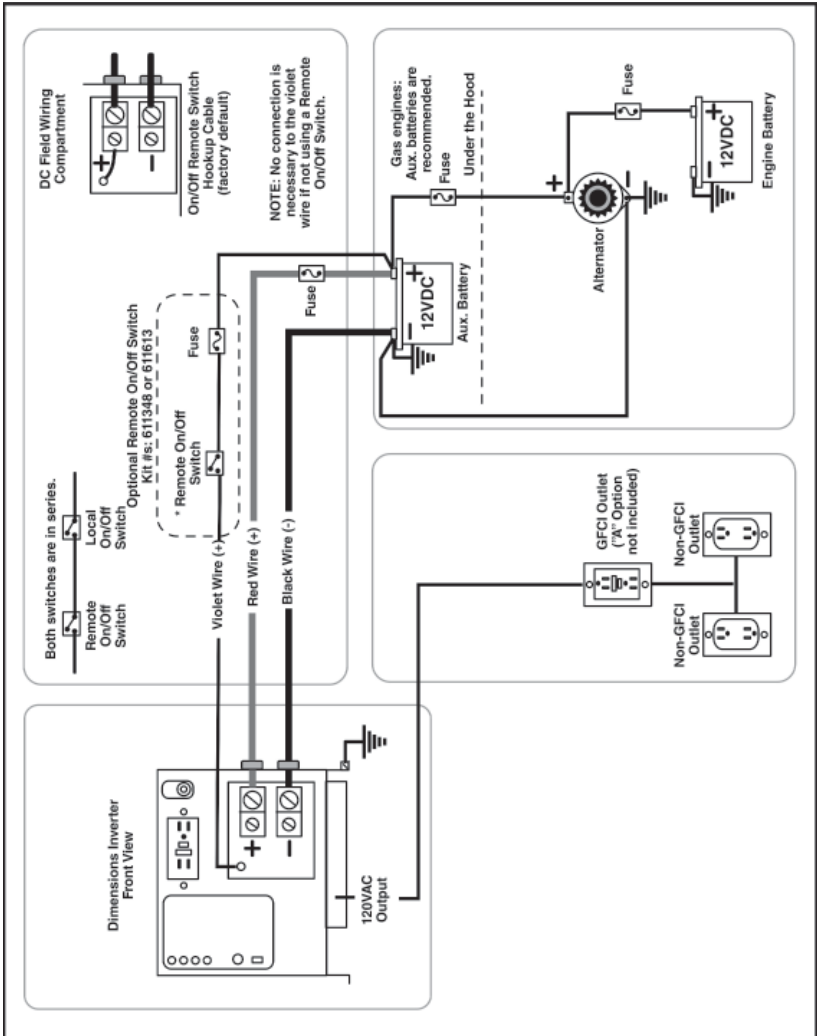

Typical Wiring Diagram for 12/1800N, 12/2400N, 12/3000N, 12/3600N

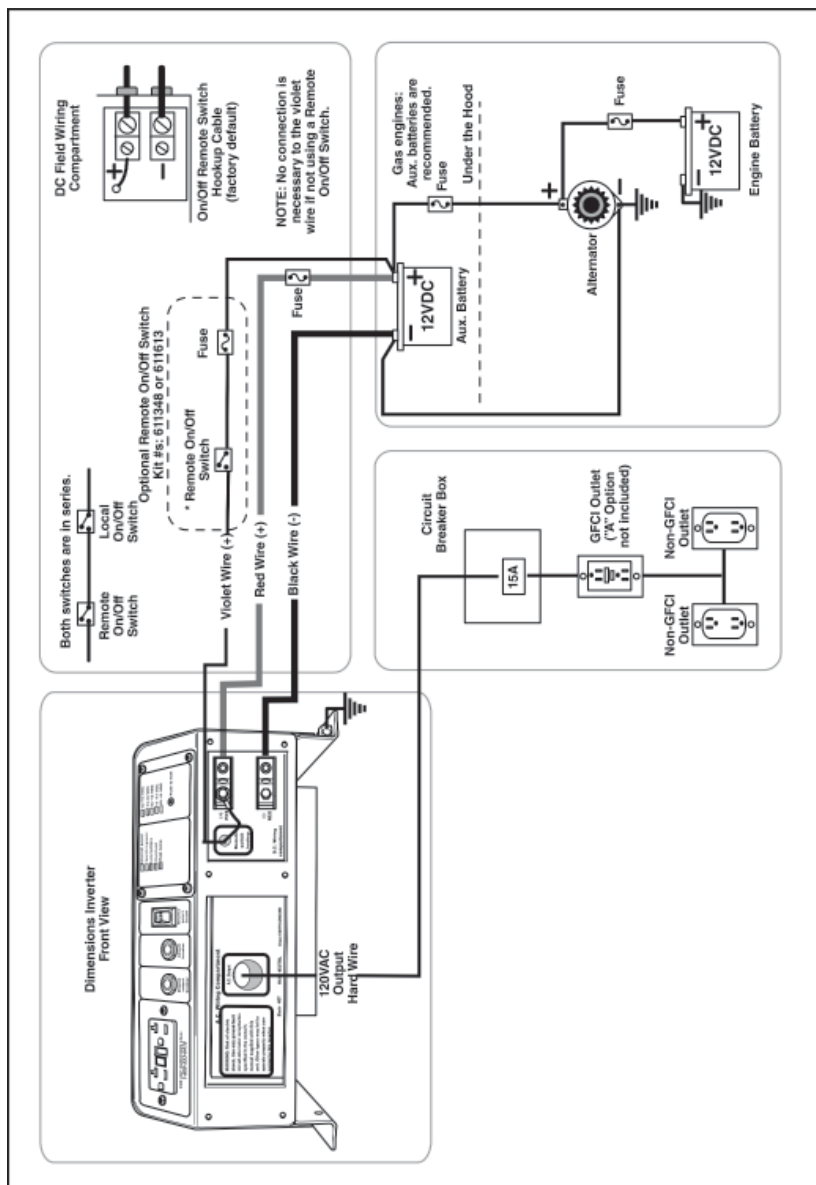

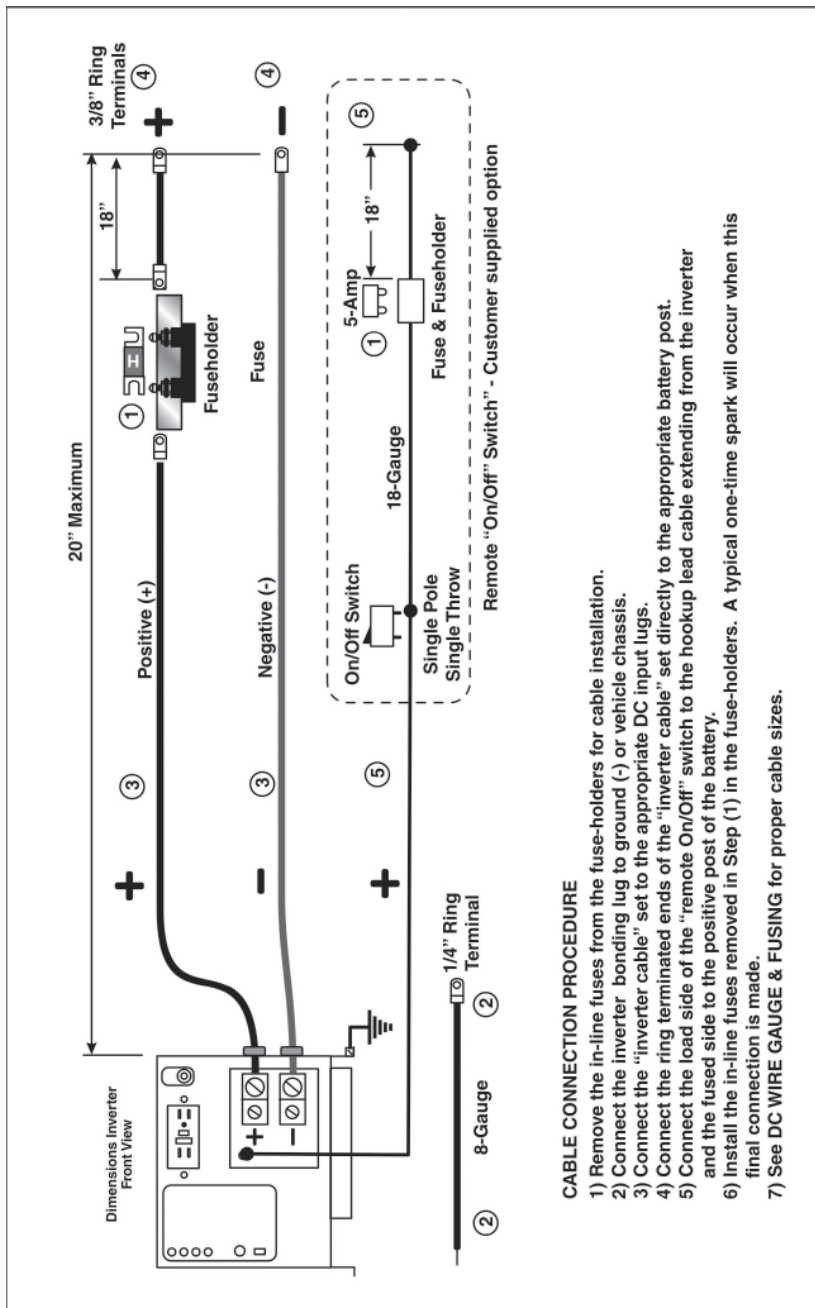

CABLE CONNECTION PROCEDURE

- 1) Remove the in-line fuses from the fuse-holders for cable installation.
- 2) Connect the inverter bonding lug to ground (-) or vehicle chassis.
- 3) Connect the "inverter cable" set to the appropriate DC input lugs.
- 4) Connect the ring terminated ends of the "inverter cable" set directly to the appropriate battery post.
- 5) Connect the load side of the "remote On/Off" switch to the hookup lead cable extending from the inverter and the fused side to the positive post of the battery.
- 6) Install the in-line fuses removed in Step (1) in the fuse-holders. A typical one-time spark will occur when this final connection is made.
- 7) See DC WIRE GAUGE & FUSING for proper cable sizes.

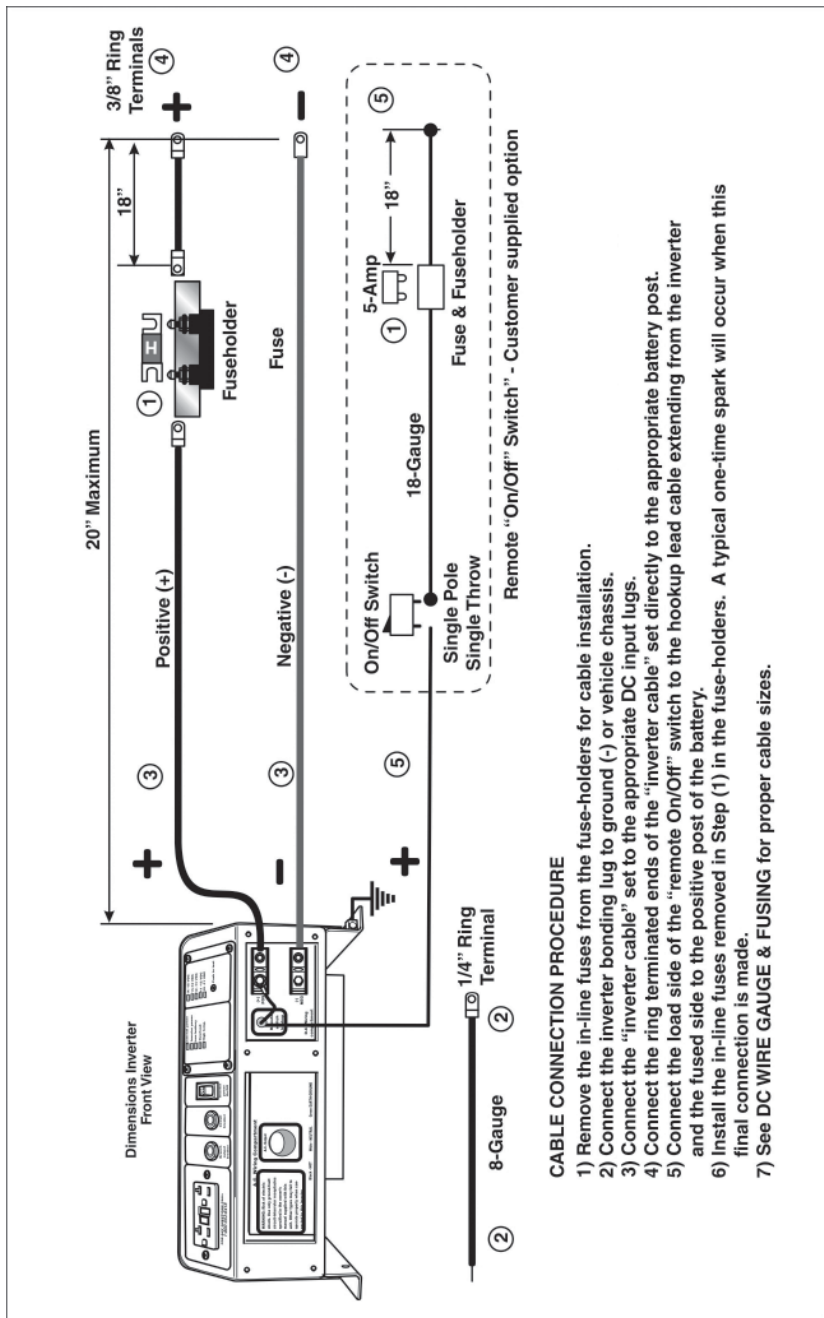

CABLE CONNECTION PROCEDURE

- 1) Remove the in-line fuses from the fuse-holders for cable installation.
- 2) Connect the inverter bonding lug to ground (-) or vehicle chassis.
- 3) Connect the "inverter cable" set to the appropriate DC input lugs.
- 4) Connect the ring terminated ends of the "inverter cable" set directly to the appropriate battery post.
- 5) Connect the load side of the "remote On/Off" switch to the hookup lead cable extending from the inverter and the fused side to the positive post of the battery.
- 6) Install the in-line fuses removed in Step (1) in the fuse-holders. A typical one-time spark will occur when this final connection is made.
- 7) See DC WIRE GAUGE & FUSING for proper cable sizes.

INVERTER TROUBLESHOOTING GUIDE

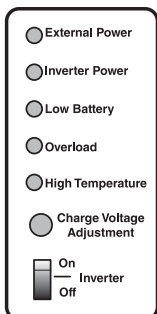

**Status Panel
12/800N & 12/1200N**

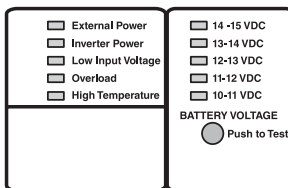

**Status Panel
12/1800N, 12/2400N,
12/3000N, & 12/3600N**

Plug a 100-watt light bulb into the inverter's AC outlet. Switch on the remote On/Off switch (if available). Switch the inverter's AC outlet On/Off for 5 seconds: then, switch it back ON. If the work light lights, the inverter works.

Symptom	Possible Cause(s)	Solution(s)
No inverter indicators are on and work light not ON.	1. No DC power to inverter. 2. No remote power on input to inverter.	Go to Troubleshooting Step 1.
Inverter POWER ON indicator is on and work light not ON.	1. Tripped inverter output circuit breaker. 2. Tripped inverter Ground Fault Circuit Interrupter.	1. Reset the output circuit breaker & retest. 2. Reset the GFCI & retest.
Inverter LOW INPUT VOLTAGE indicator is ON.	1. Low DC input power. 2. Defective inverter.	Go to Troubleshooting Step 2.
Inverter OVERLOAD indicator is ON.	1. Very excessive AC output load or AC output short. 2. Defective inverter.	Go to Troubleshooting Step 3.
Inverter HIGH TEMPERATURE indicator is ON.	1. Excessive ambient temp. 2. Excessive AC output load.	Go to Troubleshooting Step 4.

Troubleshooting Steps

Step 1. INVERTER POWER indicator LED is not ON.

A. Locate the small violet wire in the front of the inverter. Disconnect the violet wire from the external remote switch circuit. Connect the violet wire to the large positive DC input lug on the front of the inverter.

1. If the inverter powers ON, the fault exists in the remote On/Off circuit. Possible problems include:
 - A failed remote circuit fuse.
 - A defective switch.
 - A defective isolation relay in the circuit open wiring anywhere in the remote On/Off circuit to the inverter.
 - Correct the fault and retest.

B. If the inverter does not power ON, a very low or zero volt input voltage probably exists.

1. Visually inspect or remove and measure the resistance of the battery cable fuses for evidence of failure.
 - Replace any defective fuse with the same rating and retest the system.

NOTE: Repeated fuse failures are probably caused by either a positive cable shorted to ground (chassis) in the battery system or poor battery cable connections. Locate and correct the short or poor connections; then, retest the system.

2. If no fuse is defective, the battery/charging system is suspect. Contact Sensata at 1-800-553-6418 for technical assistance.

Step 2. LOW INPUT VOLTAGE indicator LED is ON.

NOTE: Failures can be caused by one or more of the following: a failed or under-rated alternator and/or failed alternator regulator, inoperative engine high idler, weak batteries, or poor battery wiring connections. The least likely part to have failed is the inverter. Contact Sensata at 1-800-553-6418 for technical assistance.

Step 3. OVERLOAD indicator LED is ON.

A. Switch the inverter OFF, and remove all AC loads from the inverter's output receptacle; then, disconnect the AC hard wire output inside the front panel of the inverter.

B. Switch the inverter to ON.

1. Inverter appears to operate normally (no indicator LED's) indicates one of the disconnected AC loads was drawing excessive current or an AC wiring short exists in the external AC wiring. Correct the fault and retest the system.
2. Overload indicator LED is ON indicating a possible defective inverter. Contact Sensata at 1-800-553-6418 for technical assistance.

Step 4. HIGH TEMPERATURE indicator LED is ON.

NOTE: Indicates that the inverter has been operated with a somewhat excessive AC load and has overheated (no damage to the inverter should have occurred).

A. The high temperature condition should self-correct in approximately one (1) minute to one (1) hour. If the condition persists longer the one (1) hour, contact Sensata at 1-800-553-6418 for technical assistance.

SPECIFICATIONS

GENERAL SPECIFICATIONS	12/800N	12/1200N	12/1500N	12/1800N	12/2400N	12/3000N	12/3600N
Output Power (Watts Continuous)	800	1200	1500	1800	2400	3000	3600
Output Current (Amps AC)	Up to 7	Up to 10	Up to 12.5	Up to 15	Up to 20	Up to 25	Up to 30
Peak Output (Amps DC)	12	21	24	44	91	91	136
Input Current (Amps DC)	Up to 80	Up to 120	Up to 150	Up to 180	Up to 240	Up to 300	Up to 360
Input Voltage (Volts DC)	10.5 to 20						
Output Voltage (Pure Sine)	120 VAC \pm 5%						
Output Frequency	60 Hz \pm 0.05%						
Output Wave Form	Pure Sine Wave, <5%						
Efficiency (Inverter)	Up to 88%						
Operating Temperature	0° to 140° F [-20° to 60° C]						
Case Size (L x W x H)	15 x 8.2 x 7.5			15 x 16 x 7.5			15 x 17 x 10
Weight (Lbs)	25	29	29	42	56	58	80

OTHER DESIGN FEATURES

- High performance construction and cooling methods.
- Microprocessor controlled.
- Thermally controlled cooling fan.
- Enclosed AC and DC cable connections.
- Remote ON/OFF switch hookup.
- GFCI outlet protection.
- LED indication of External power, Inverter power, Low input voltage, High temperature, and Overload.
- Battery voltage indicator with push-to-test (12/1800N, 12/2400N, 12/3000N, and 12/3600N) only.
- Remote control "R".

UNIT PROTECTION

- Automatic electronic short circuit/overload protection.
- Automatic over temperature shutdown.
- Output circuit breakers.

BATTERY PROTECTION

- Automatic low battery shutdown at 10.5 VDC (with in-rush delay).

Usage: Any 120 VAC, 60 Hz single phase product within the inverter's power rating.

Warranty: See product label on top of the inverter for warranty period.

LIMITED WARRANTY TERMS & CONDITIONS

SHIPPING TERMS: F.O.B. St. Paul Minnesota. Freight prepaid and billed, subject to prior credit approval.

MINIMUM ORDER: \$50.00 Net Price

LOSS OR DAMAGE: Loss or damage in transit is the responsibility of the carrier; any claim should be filed with the delivering transport company. Invoice, Bill of Lading and Delivery receipt with damage noted therein must accompany any claims for freight damage. Claims for shortage and lost shipments must be made in writing to Sensata Technologies Maryland Inc., St. Paul, MN within 10 days of date of shipment. Claims not reported within this time frame will not be honored.

PRICES: Prices are subject to change without notice. All orders are subject to acceptance at the factory. We reserve the right to invoice prices in effect at time of shipment.

TERMS: Net 30 days with approved credit, credit card or C.O.D.

RETURN GOODS POLICY:

- No returned materials will be accepted without an accompanying Returned Materials Authorization Number (RMA) from the factory.
- Credit will be issued for returned goods to the original purchaser within 60 days of purchase, provided the inverter is returned to Sensata unused and not mounted. The amount of credit will be issued at Sensata's discretion based on the condition of the product.
- Customer must be in good standing with Sensata Technologies.
- Inverters that are discontinued, high-voltage (over 24vdc), special-order or used are excluded and will not be eligible for credit. Non-inverter items such as cable assemblies, fuses and fuse holders, will not be eligible for credit
- Support components supplied by Sensata vendors will be covered under that manufacturer's credit return policy.
- Customer pays return freight.

PLEASE SHIP AUTHORIZED RETURNS TO:

Sensata Technologies RMA # _____ | 4467 White Bear Parkway | St. Paul, MN 55110
Return Freight Prepaid

LIMITED WARRANTY:

Sensata Technologies extends the following warranty to the original purchaser of those goods subject to the qualifications indicated. Sensata warrants to the original purchaser for use that the goods or any component thereof manufactured by Sensata will be free from defects in workmanship from the date of purchase for the period listed on the product label, provided such goods are installed, maintained and used in accordance with Sensata and the original manufacturer's written instructions. Damages caused by the misuse, undue care or obvious wear through use will not be covered by this warranty.

Components not manufactured by Sensata, but used within the assembly provided by Sensata, are subject to the warranty period as specified by the individual manufacturer of said component, provided such goods are installed, maintained and used in accordance with Sensata and the manufacturer's written instructions.

Sensata sole liability and the Purchaser's sole remedy for a failure of goods under this limited warranty and for any and all claims arising out of the purchase and use of the goods shall be limited to the repair or replacement of the goods that do not conform to this warranty.

To obtain repair or replacement service under the limited warranty, the purchaser must contact the factory for a Return Material Authorization (RMA) number. Once obtained, send the Return Material Authorization Number along with the defective part or goods to: Sensata Technologies RMA # _____, 4467 White Bear Parkway, St. Paul, MN 55110 Return Freight Prepaid.

THERE ARE NO EXPRESS WARRANTIES COVERING THESE GOODS OTHER THAN AS SET FORTH ABOVE. THE IMPLIED WARRANTIES OF MERCHANTABILITY AND FITNESS FOR A PARTICULAR PURPOSE ARE LIMITED IN DURATION TO ONE YEAR FROM DATE OF PURCHASE.

SENSATA TECHNOLOGIES MARYLAND INC. ASSUMES NO LIABILITY IN CONNECTION WITH THE INSTALLATION OR USE OF THE PRODUCT, EXCEPT AS STATED IN THIS LIMITED WARRANTY. SENSATA TECHNOLOGIES WILL IN NO EVENT BE LIABLE FOR INCIDENTAL OR CONSEQUENTIAL DAMAGES.

WARNING: LIMITATIONS ON USE: DIMENSIONS® brand inverter products are not intended for use in connection with Life Support Systems and for Avionic use. Sensata Technologies makes no warranty or representation in connection with their products for such uses.

Notes:

Sensata Technologies
Manufacturer of Dimensions Inverters
4467 White Bear Parkway
St. Paul, MN 55110
Phone: 651-653-7000; 800-553-6418
Fax: 651-653-7600; 888-439-3565
inverterinfo@sensata.com
www.dimensions.sensata.com

Form No. 122187 (08/28/12)
© Sensata Technologies 2012
Printed in U.S.A.

