



samlexpower®

**DC-AC Power
Inverter**
Pure Sine Wave

PST-60S-12E
PST-60S-24E
PST-100S-12E
PST-100S-24E
PST-150S-12E
PST-150S-24E
PST-200S-12E
PST-200S-24E

**Owner's
Manual**

Please read this
manual **BEFORE**
installing your
inverter

OWNER'S MANUAL | Index

SECTION 1	Safety Instructions	3
SECTION 2	General Information	6
SECTION 3	EMC (EMI/EMS) Compliance	13
SECTION 4	Powering Direct / Embedded Switch Mode Power Supplies (SMPS)	14
SECTION 5	Principle of Operation	16
SECTION 6	Layout.....	17
SECTION 7	General Information on Lead-Acid Batteries	18
SECTION 8	Installation	29
SECTION 9	Operation	41
SECTION 10	Protections	43
SECTION 11	Troubleshooting Guide	46
SECTION 12	Specifications	48
SECTION 13	Warranty	52

Disclaimer of Liability

UNLESS SPECIFICALLY AGREED TO IN WRITING, SAMLEX AMERICA, INC.:

1. MAKES NO WARRANTY AS TO THE ACCURACY, SUFFICIENCY OR SUITABILITY OF ANY TECHNICAL OR OTHER INFORMATION PROVIDED IN ITS MANUALS OR OTHER DOCUMENTATION.
2. ASSUMES NO RESPONSIBILITY OR LIABILITY FOR LOSSES, DAMAGES, COSTS OR EXPENSES, WHETHER SPECIAL, DIRECT, INDIRECT, CONSEQUENTIAL OR INCIDENTAL, WHICH MIGHT ARISE OUT OF THE USE OF SUCH INFORMATION. THE USE OF ANY SUCH INFORMATION WILL BE ENTIRELY AT THE USERS RISK.

Samlex America reserves the right to revise this document and to periodically make changes to the content hereof without obligation or organization of such revisions or changes.

Copyright Notice/Notice of Copyright

Copyright © 2016 by Samlex America, Inc. All rights reserved. Permission to copy, distribute and /or modify this document is prohibited without express written permission by Samlex America, Inc.

SECTION 1 | Safety Instructions

1.1 IMPORTANT SAFETY INSTRUCTIONS AND SYMBOLS

SAVE THESE INSTRUCTIONS. This manual contains important instructions for models PST-60S / 100S / 150S / 200S that shall be followed during installation, operation and maintenance.

The following safety symbols will be used in this manual to highlight safety and information:



WARNING!

Indicates possibility of physical harm to the user in case of non-compliance.



CAUTION!

Indicates possibility of damage to the equipment in case of non-compliance.



INFO

Indicates useful supplemental information.

Please read these instructions before installing or operating the unit to prevent personal injury or damage to the unit.

1.2 SAFETY INSTRUCTIONS - GENERAL

Installation and wiring compliance

- Installation and wiring must comply with the Local and National Electrical Codes and must be done by a certified electrician.

Preventing electrical shock

- Both the output sockets L1 and L2 of the Schuko Receptacle are LIVE/HOT and are floating with respect to the metal chassis Ground/Earth Ground (there is NO Neutral). **Do not touch!** Refer to Section 8.5.1 for details.
- Always connect the grounding connection on the unit to the appropriate grounding system.
- Disassembly / repair should be carried out by qualified personnel only.
- Disconnect all AC and DC side connections before working on any circuits associated with the unit. Turning the ON/OFF switch on the unit to OFF position may not entirely remove dangerous voltages.
- Be careful when touching bare terminals of capacitors. Capacitors may retain high lethal voltages even after the power has been removed. Discharge the capacitors before working on the circuits.

SECTION 1 | Safety Instructions

Installation environment

- The inverter should be installed indoor only in a well ventilated, cool, dry environment.
- Do not expose to moisture, rain, snow or liquids of any type.
- To reduce the risk of overheating and fire, do not obstruct the suction and discharge openings of the cooling fan.
- To ensure proper ventilation, do not install in a low clearance compartment.

Preventing fire and explosion hazards

- Working with the unit may produce arcs or sparks. Thus, the unit should not be used in areas where there are flammable materials or gases requiring ignition protected equipment. These areas may include spaces containing gasoline-powered machinery, fuel tanks, and battery compartments.

Precautions when working with batteries

- Batteries contain very corrosive diluted Sulphuric Acid as electrolyte. Precautions should be taken to prevent contact with skin, eyes or clothing.
- Batteries generate Hydrogen and Oxygen during charging resulting in evolution of explosive gas mixture. Care should be taken to ventilate the battery area and follow the battery manufacturer's recommendations.
- Never smoke or allow a spark or flame near the batteries.
- Use caution to reduce the risk of dropping a metal tool on the battery. It could spark or short circuit the battery or other electrical parts and could cause an explosion.
- Remove metal items like rings, bracelets and watches when working with batteries. The batteries can produce a short circuit current high enough to weld a ring or the like to metal and, thus, cause a severe burn.
- If you need to remove a battery, always remove the ground terminal (Negative) from the battery first. Make sure that all the accessories are off so that you do not cause a spark.

1.3 SAFETY INSTRUCTIONS - INVERTER RELATED

Preventing Paralleling of the AC Output

The AC output of the unit should never be connected directly to an Electrical Breaker Panel / Load Centre which is also fed from the utility power / generator. Such a direct connection may result in parallel operation of the different power sources and AC power from the utility / generator will be fed back into the unit which will instantly damage the output section of the unit and may also pose a fire and safety hazard. If an Electrical Breaker Panel / Load Center is fed from this unit and this panel is also required to be fed from additional alternate AC sources, the AC power from all the AC sources (like the utility / generator / this inverter) should first be fed to an Automatic / Manual Selector Switch and the output of the Selector Switch should be connected to the Electrical Breaker Panel / Load Center.

SECTION 1 | Safety Instructions



CAUTION!

To prevent possibility of paralleling and severe damage to the unit, never use a simple jumper cable with a male plug on both ends to connect the AC output of the unit to a handy wall receptacle in the home / RV / motorhome / caravan.

Preventing DC Input Over Voltage

It is to be ensured that the DC input voltage of this unit does not exceed 16.5 VDC for the 12V versions or 33.0 VDC for the 24V versions to prevent permanent damage to the unit. Please observe the following precautions:

- Ensure that the maximum charging voltage of the external battery charger / alternator / solar charge controller does not exceed 16.5 VDC for the 12V versions or 33.0 VDC for the 24V versions.
- Do not use unregulated solar panels to charge the battery connected to this unit. Under cold ambient temperatures, the output of the solar panel may reach > 22 VDC for 12V Battery System and > 44 VDC for the 24V Battery system. Always use a charge controller between the solar panel and the battery.
- Do not connect this unit to a battery system with a voltage higher than the rated battery input voltage of the unit [e.g. do not connect the 12V versions to 24V or 48V battery system or the 24V versions to the 48V Battery System].
- When using Diversion Charge Control Mode in a charge controller, the solar / wind / hydro source is directly connected to the battery bank. In this case, the controller will divert excess current to an external load. As the battery charges, the diversion duty cycle will increase. When the battery is fully charged, all the source energy will flow into the diversion load if there are no other loads. The charge controller will disconnect the diversion load if the current rating of the controller is exceeded. Disconnection of the diversion load may damage the battery as well as the inverter or other DC loads connected to the battery due to high voltages generated during conditions of high winds (for wind generators), high water flow rates (for hydro generators). It is, therefore, to be ensured that the diversion load is sized correctly to prevent the above over voltage conditions.

Preventing Reverse Polarity on the Input Side

When making battery connections on the input side, make sure that the polarity of battery connections is correct (Connect the Positive of the battery to the Positive terminal of the unit and the Negative of the battery to the Negative terminal of the unit). If the input is connected in reverse polarity, the external DC fuse and the DC fuses inside the inverter will blow and may also cause permanent damage to the inverter.



CAUTION!

Damage caused by reverse polarity is not covered by warranty.

SECTION 1 | Safety Instructions

Use of External Fuse in DC Input Circuit

Use UL Class T (As per UL Standard UL 248-15 / Type "HRC" as per BS88-2 or as per IEC 60269-2) or equivalent fuse of appropriate capacity within 7" of the battery Positive terminal. This fuse is required to protect DC input cable run from damage due to short circuit along the length of the cable. Please read instructions under Section 8.4.5 - Installation.

Hard Wiring of AC Output to AC Panelboards in RVs / Motor Homes / Trailers / Campers



WARNING! **RISK OF ELECTRIC SHOCK**

When this unit is installed in RV / Motor Homes / Trailers / Campers and hard-wiring connection is used to feed the AC output of the inverter to the AC Distribution Panelboard / Load Center in the vehicle, it is to be ensured that the AC output is fed to the Panel Board through appropriate Residual Current Detector (RCD) or Ground Fault Circuit Interrupter [GFCI].

SECTION 2 | General Information

2.1. DEFINITIONS

The following definitions are used in this manual for explaining various electrical concepts, specifications and operations:

Peak Value: It is the maximum value of electrical parameter like voltage / current.

RMS (Root Mean Square) Value: It is a statistical average value of a quantity that varies in value with respect to time. For example, a pure sine wave that alternates between peak values of Positive 329.22V and Negative 329.22V has an RMS value of 230 VAC. Also, for a pure sine wave, the RMS value = Peak value \div 1.414.

Voltage (V), Volts: It is denoted by "V" and the unit is "Volts". It is the electrical force that drives electrical current (I) when connected to a load. It can be DC (Direct Current – flow in one direction only) or AC (Alternating Current – direction of flow changes periodically). The AC value shown in the specifications is the RMS (Root Mean Square) value.

Current (I), Amps, A: It is denoted by "I" and the unit is Amperes – shown as "A". It is the flow of electrons through a conductor when a voltage (V) is applied across it.

Frequency (F), Hz: It is a measure of the number of occurrences of a repeating event per unit time. For example, cycles per second (or Hertz) in a sinusoidal voltage.

Efficiency, (η): This is the ratio of Active Power Output in Watts \div Active Power Input in Watts.

SECTION 2 | General Information

Phase Angle, (ϕ): It is denoted by " ϕ " and specifies the angle in degrees by which the current vector leads or lags the voltage vector in a sinusoidal voltage. In a purely inductive load, the current vector lags the voltage vector by Phase Angle (ϕ) = 90° . In a purely capacitive load, the current vector leads the voltage vector by Phase Angle, (ϕ) = 90° . In a purely resistive load, the current vector is in phase with the voltage vector and hence, the Phase Angle, (ϕ) = 0° . In a load consisting of a combination of resistances, inductances and capacitances, the Phase Angle (ϕ) of the net current vector will be $> 0^\circ < 90^\circ$ and may lag or lead the voltage vector.

Resistance (R), Ohm, Ω : It is the property of a conductor that opposes the flow of current when a voltage is applied across it. In a resistance, the current is in phase with the voltage. It is denoted by "R" and its unit is "Ohm" - also denoted as " Ω ".

Inductive Reactance (X_L), Capacitive Reactance (X_C) and Reactance (X): Reactance is the opposition of a circuit element to a change of electric current or voltage due to that element's inductance or capacitance. Inductive Reactance (X_L) is the property of a coil of wire in resisting any change of electric current through the coil. It is proportional to frequency and inductance and causes the current vector to lag the voltage vector by Phase Angle (ϕ) = 90° . Capacitive reactance (X_C) is the property of capacitive elements to oppose changes in voltage. X_C is inversely proportional to the frequency and capacitance and causes the current vector to lead the voltage vector by Phase Angle (ϕ) = 90° . The unit of both X_L and X_C is "Ohm" - also denoted as " Ω ". The effects of inductive reactance X_L to cause the current to lag the voltage by 90° and that of the capacitive reactance X_C to cause the current to lead the voltage by 90° are exactly opposite and the net effect is a tendency to cancel each other. Hence, in a circuit containing both inductances and capacitances, the net **Reactance (X)** will be equal to the difference between the values of the inductive and capacitive reactances. The net **Reactance (X)** will be inductive if $X_L > X_C$ and capacitive if $X_C > X_L$.

Impedance, Z: It is the vectorial sum of Resistance and Reactance vectors in a circuit.

Active Power (P), Watts: It is denoted as "**P**" and the unit is "**Watt**". It is the power that is consumed in the resistive elements of the load. A load will require additional Reactive Power for powering the inductive and capacitive elements. The effective power required would be the Apparent Power that is a vectorial sum of the Active and Reactive Powers.

Reactive Power (Q), VAR: Is denoted as "**Q**" and the unit is **VAR**. Over a cycle, this power is alternatively stored and returned by the inductive and capacitive elements of the load. It is not consumed by the inductive and capacitive elements in the load but a certain value travels from the AC source to these elements in the (+) half cycle of the sinusoidal voltage (Positive value) and the same value is returned back to the AC source in the (-) half cycle of the sinusoidal voltage (Negative value). Hence, when averaged over a span of one cycle, the net value of this power is 0. However, on an instantaneous basis, this power has to be provided by the AC source. *Hence, the inverter, AC wiring and over current protection devices have to be sized based on the combined effect of the Active and Reactive Powers that is called the Apparent Power.*

SECTION 2 | General Information

Apparent (S) Power, VA: This power, denoted by "S", is the vectorial sum of the Active Power in Watts and the Reactive Power in "VAR". In magnitude, it is equal to the RMS value of voltage "V" X the RMS value of current "A". The Unit is VA. *Please note that Apparent Power VA is more than the Active Power in Watts. Hence, the inverter, AC wiring and over current protection devices have to be sized based on the Apparent Power.*

Maximum Continuous Running AC Power Rating: This rating may be specified as "Active Power" in Watts (W) or "Apparent Power" in Volt Amps (VA). It is normally specified in "Active Power (P)" in Watts for Resistive type of loads that have Power Factor =1. Reactive types of loads will draw higher value of "Apparent Power" that is the sum of "Active and Reactive Powers". Thus, AC power source should be sized based on the higher "Apparent Power" Rating in (VA) for all Reactive Types of AC loads. If the AC power source is sized based on the lower "Active Power" Rating in Watts (W), the AC power source may be subjected to overload conditions when powering Reactive Type of loads.

Surge Power Rating: During start up, certain loads require considerably higher surge of power for short duration (lasting from tens of millisecs to few seconds) as compared to their Maximum Continuous Running Power Rating. Some examples of such loads are given below:

- **Electric Motors:** At the moment when an electric motor is powered ON, the rotor is stationary (equivalent to being "Locked"), there is no "Back EMF" and the windings draw a very heavy surge of starting current (Amperes) called "Locked Rotor Amperes" (LRA) due to low DC resistance of the windings. For example, in motor driven loads like Air-conditioning and Refrigeration Compressors and in Well Pumps (using Pressure Tank), the Starting Surge Current / LRA may be as high as 10 times its rated Full Load Amps (FLA) / Maximum Continuous Running Power Rating. The value and duration of the Starting Surge Current / LRA of the motor depends upon the winding design of the motor and the inertia / resistance to movement of mechanical load being driven by the motor. As the motor speed rises to its rated RPM, "Back EMF" proportional to the RPM is generated in the windings and the current draw reduces proportionately till it draws the running FLA / Maximum Continuous Running Power Rating at the rated RPM.
- **Transformers (e.g. Isolation Transformers, Step-up / Step-down Transformers, Power Transformer in Microwave Oven etc.):** At the moment when AC power is supplied to a transformer, the transformer draws very heavy surge of "Magnetization Inrush Current" for a few millisecs that can reach up to 10 times the Maximum Continuous Rating of the Transformer.
- **Devices like Infrared Quartz Halogen Heaters (also used in Laser Printers) / Quartz Halogen Lights / Incandescent Light Bulbs using Tungsten heating elements:** Tungsten has a very high Positive Temperature Coefficient of Resistance i.e. it has lower resistance when cold and higher resistance when hot. As Tungsten heating element will be cold at the time of powering ON, its resistance will be low and hence, the device will draw very heavy surge of current with consequent very heavy surge of power with a value of up to 8 times the Maximum Continuous Running AC Power.

SECTION 2 | General Information

- **AC to DC Switched Mode Power Supplies (SMPS):** This type of power supply is used as stand-alone power supply or as front end in all electronic devices powered from Utility / Grid e.g. in audio/video/ computing devices and battery chargers (Please see Section 4 for more details on SMPS). When this power supply is switched ON, its internal input side capacitors start charging resulting in very high surge of Inrush Current for a few milliseconds (Please see Fig 4.1). This surge of inrush current / power may reach up to 15 times the Continuous Maximum Running Power Rating. The surge of inrush current / power will, however, be limited by the Surge Power Rating of the AC source.

Power Factor, (PF): It is denoted by “PF” and is equal to the ratio of the Active Power (P) in Watts to the Apparent Power (S) in VA. The maximum value is 1 for resistive types of loads where the Active Power (P) in Watts = the Apparent Power (S) in VA. It is 0 for purely inductive or purely capacitive loads. Practically, the loads will be a combination of resistive, inductive and capacitive elements and hence, its value will be $> 0 < 1$. Normally it ranges from 0.5 to 0.8 e.g. (i) AC motors (0.4 to 0.8), (ii) Transformers (0.8) (iii) AC to DC Switch Mode Power Supplies (0.5 to 0.6) etc.

Load: Electrical appliance or device to which an electrical voltage is fed.

Linear Load: A load that draws sinusoidal current when a sinusoidal voltage is fed to it. Examples are, incandescent lamp, heater, electric motor, etc.

Non-Linear Load: A load that does not draw a sinusoidal current when a sinusoidal voltage is fed to it. For example, non-power factor corrected Switched Mode Power Supplies (SMPS) used in computers, audio video equipment, battery chargers, etc.

Resistive Load: A device or appliance that consists of pure resistance (like filament lamps, cook tops, toaster, coffee maker etc.) and draws only Active Power (Watts) from the inverter. The inverter can be sized based on the Active Power rating (Watts) of resistive type of loads without creating overload (except for resistive type of loads with Tungsten based heating element like in Incandescent Light Bulbs, Quartz Halogen Lights and Quartz Halogen Infrared Heaters. These require higher starting surge power due to lower resistance value when the heating element is cold).

Reactive Load: A device or appliance that consists of a combination of resistive, inductive and capacitive elements (like motor driven tools, refrigeration compressors, microwaves, computers, audio/ video etc.). The Power Factor of this type of load is < 1 e.g. AC motors (PF=0.4 to 0.8), Transformers (PF=0.8), AC to DC Switch Mode Power Supplies (PF=0.5 to 0.6) etc. These devices require Apparent Power (VA) from the AC power source. The Apparent Power is a vectorial sum of Active Power (Watts) and Reactive Power (VAR). *The AC power source has to be sized based on the higher Apparent Power (VA) and also based on the Starting Surge Power.*

SECTION 2 | General Information

2.2 OUTPUT VOLTAGE WAVEFORMS

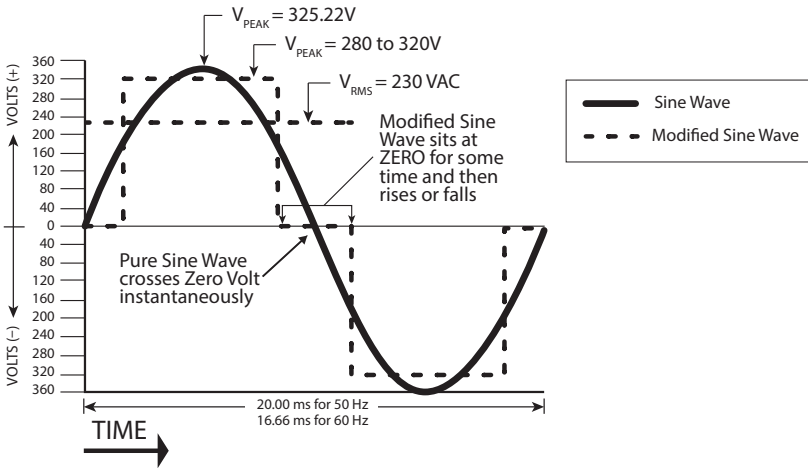

Fig. 2.1: Pure and Modified Sine Waveforms for 230 VAC, 50/60 Hz

The output waveform of the Samlex PST series inverters is a Pure Sine Wave like the waveform of Utility / Grid Power. Please see Sine Wave represented in the Fig. 2.1 that also shows Modified Sine Waveform for comparison.

In a Sine Wave, the voltage rises and falls smoothly with a smoothly changing phase angle and also changes its polarity instantly when it crosses 0 Volts. In a Modified Sine Wave, the voltage rises and falls abruptly, the phase angle also changes abruptly and it sits at zero V for some time before changing its polarity. Thus, any device that uses a control circuitry that senses the phase (for voltage / speed control) or instantaneous zero voltage crossing (for timing control) will not work properly from a voltage that has a Modified Sine Waveform.

Also, as the Modified Sine Wave is a form of Square Wave, it is comprised of multiple Sine Waves of odd harmonics (multiples) of the fundamental frequency of the Modified Sine Wave. For example, a 50 Hz Modified Sine Wave will consist of Sine Waves with odd harmonic frequencies of 3rd (150 Hz), 5th (250 Hz), 7th (350 Hz) and so on. The high frequency harmonic content in a Modified Sine Wave produces enhanced radio interference, higher heating effect in inductive loads like microwaves and motor driven devices like hand tools, refrigeration / air-conditioning compressors, pumps etc. The higher frequency harmonics also produce overloading effect in low frequency capacitors due to lowering of their capacitive reactance by the higher harmonic frequencies. These capacitors are used in ballasts for fluorescent lighting for Power Factor improvement and in single-phase induction motors as Start and Run Capacitors. Thus, Modified and Square Wave inverters may shut down due to overload when powering these devices.

SECTION 2 | General Information

2.3 ADVANTAGES OF PURE SINE WAVE INVERTERS

- The output waveform is a Sine Wave with very low harmonic distortion and cleaner power like Utility / Grid supplied electricity.
- Inductive loads like microwaves, motors, transformers etc. run faster, quieter and cooler.
- More suitable for powering fluorescent lighting fixtures containing Power Factor Improvement Capacitors and single phase motors containing Start and Run Capacitors
- Reduces audible and electrical noise in fans, fluorescent lights, audio amplifiers, TV, fax and answering machines, etc.
- Does not contribute to the possibility of crashes in computers, weird print outs and glitches in monitors.

2.4 SOME EXAMPLES OF DEVICES THAT MAY NOT WORK PROPERLY WITH MODIFIED SINE WAVE AND MAY ALSO GET DAMAGED ARE GIVEN BELOW:

- Laser printers, photocopiers, and magneto-optical hard drives.
- Built-in clocks in devices such as clock radios, alarm clocks, coffee makers, bread-makers, VCR, microwave ovens etc. may not keep time correctly.
- Output voltage control devices like dimmers, ceiling fan / motor speed control may not work properly (dimming / speed control may not function).
- Sewing machines with speed / microprocessor control.
- Transformer-less capacitive input powered devices like (i) Razors, flashlights, night-lights, smoke detectors etc. (ii) Some re-chargers for battery packs used in hand power tools. *These may get damaged. Please check with the manufacturer of these types of devices for suitability.*
- Devices that use radio frequency signals carried by the AC distribution wiring.
- Some new furnaces with microprocessor control / Oil burner primary controls.
- High intensity discharge (HID) lamps like Metal Halide Lamps. *These may get damaged. Please check with the manufacturer of these types of devices for suitability.*
- Some fluorescent lamps / light fixtures that have Power Factor Correction Capacitors. *The inverter may shut down indicating overload.*
- Induction Cooktops

2.5 POWER RATING OF INVERTERS



INFO

For proper understanding of explanations given below, please refer to definitions of Active / Reactive / Apparent / Continuous / Surge Powers, Power Factor, and Resistive / Reactive Loads at Section 2.1 under "DEFINITIONS".

SECTION 2 | General Information

The power rating of inverters is specified as follows:

- Maximum Continuous Running Power Rating
- Surge Power Rating to accommodate high, short duration surge of power required during start up of certain AC appliances and devices.

Please read details of the above two types of power ratings in Section 2.1 under “DEFINITIONS”



INFO

The manufacturers’ specification for power rating of AC appliances and devices indicates only the Maximum Continuous Running Power Rating. The high, short duration surge of power required during start up of some specific types of devices has to be determined by actual testing or by checking with the manufacturer. This may not be possible in all cases and hence, can be guessed at best, based on some general Rules of Thumb.

Table 2.1 provides a list of some common AC appliances / devices that require high, short duration surge of power during start up. An “Inverter Sizing Factor” has been recommended against each which is a Multiplication Factor to be applied to the Maximum Continuous Running Power Rating (Active Power Rating in Watts) of the AC appliance / device to arrive at the Maximum Continuous Running Power Rating of the inverter (Multiply the Maximum Continuous Running Power Rating (Active Power Rating in Watts) of the appliance / device by recommended Sizing Factor to arrive at the Maximum Continuous Running Power Rating of the inverter.

TABLE 2.1: INVERTER SIZING FACTOR Type of Device or Appliance	Inverter Sizing Factor (See note 1)
Air Conditioner / Refrigerator / Freezer (Compressor based)	5
Air Compressor	4
Sump Pump / Well Pump / Submersible Pump	3
Dishwasher / Clothes Washer	3
Microwave (where rated output power is the cooking power)	2
Furnace Fan	3
Industrial Motor	3
Portable Kerosene / Diesel Fuel Heater	3
Circular Saw / Bench Grinder	3
Incandescent / Halogen / Quartz Lamps	3
Laser Printer / Other Devices using Infrared Quartz Halogen Heaters	4
Switch Mode Power Supplies (SMPS): no Power Factor correction	2
Photographic Strobe / Flash Lights	4 (See Note 2)

SECTION 2 | General Information

NOTES FOR TABLE 2.1

1. Multiply the Maximum Continuous Running Power Rating (Active Power Rating in Watts) of the appliance / device by the recommended Sizing Factor to arrive at the Maximum Continuous Running Power Rating of the inverter.
2. For photographic strobe / flash unit, the Surge Power Rating of the inverter should be > 4 times the Watt Sec rating of photographic strobe / flash unit.

SECTION 3 | EMC (EMI / EMS) Compliance

3.1 EMC (EMI / EMS) COMPLIANCE

These inverters contain internal switching devices that generate conducted and radiated electromagnetic interference (EMI). The EMI is unintentional and cannot be entirely eliminated. The magnitude of EMI is, however, limited by circuit design to acceptable levels as per limits laid down in European Standard EN 55022, Class B. These limits are designed to provide reasonable protection against harmful interference when the equipment is operated *in business / commercial / industrial environments*. These inverters can conduct and radiate radio frequency energy and, if not installed and used in accordance with the instruction manual, may cause harmful interference to radio communications.

The unit complies with European EMC Directive 2014/30/EU. Please see specifications at Section 12 for relevant European Standards.

3.2 REDUCING EMI THROUGH PROPER INSTALLATION

The effects of EMI will also depend upon a number of factors external to the inverter like proximity of the inverter to the EMI receptors, types and quality of connecting wires and cables etc. EMI due to factors external to the inverter may be reduced as follows:

- Ensure that the inverter is firmly grounded to the ground system of the building or the vehicle
- Locate the inverter as far away from the EMI receptors like radio, audio and video devices as possible
- Keep the DC side wires between the battery and the inverter as short as possible.
- Do NOT keep the battery wires far apart. Keep them taped together to reduce their inductance and induced voltages. This reduces ripple in the battery wires and improves performance and efficiency.
- Shield the DC side wires with metal sheathing / copper foil / braiding:
 - Use coaxial shielded cable for all antenna inputs (instead of 300 ohm twin leads)
 - Use high quality shielded cables to attach audio and video devices to one another
- Limit operation of other high power loads when operating audio / video equipment

SECTION 4 | Powering Direct / Embedded Switch Mode Power Supplies (SMPS)

4.1 CHARACTERISTICS OF SWITCHED MODE POWER SUPPLIES (SMPS)

Switch Mode Power Supplies (SMPS) are extensively used to convert the incoming AC power into various voltages like 3.3V, 5V, 12V, 24V etc. that are used to power various devices and circuits used in electronic equipment like battery chargers, computers, audio and video devices, radios etc. SMPS use large capacitors in their input section for filtration. When the power supply is first turned on, there is a very large inrush current drawn by the power supply as the input capacitors are charged (The capacitors act almost like a short circuit at the instant the power is turned on). The inrush current at turn-on is several to tens of times larger than the rated RMS input current and lasts for a few milliseconds. An example of the input voltage versus input current waveforms is given in Fig. 4.1. It will be seen that the initial input current pulse just after turn-on is > 15 times larger than the steady state RMS current. The inrush dissipates in around 2 or 3 cycles i.e. in around 33 to 50 milliseconds for 60 Hz sine wave.

Further, due to the presence of high value of input filter capacitors, the current drawn by an SMPS (With no Power Factor correction) is not sinusoidal but non-linear as shown in Fig 4.2. The steady state input current of SMPS is a train of non-linear pulses instead of a sinusoidal wave. These pulses are two to four milliseconds duration each with a very high Crest Factor of around 3 (Crest Factor = Peak value ÷ RMS value).

Many SMPS units incorporate "Inrush Current Limiting". The most common method is the NTC (Negative Temperature Coefficient) resistor. The NTC resistor has a high resistance when cold and a low resistance when hot. The NTC resistor is placed in series with the input to the power supply. The cold resistance limits the input current as the input capacitors charge up. The input current heats up the NTC and the resistance drops during normal operation. However, if the power supply is quickly turned off and back on, the NTC resistor will be hot so its low resistance state will not prevent an inrush current event.

The inverter should, therefore, be sized adequately to withstand the high inrush current and the high Crest Factor of the current drawn by the SMPS. Normally, inverters have short duration Surge Power Rating of 2 times their Maximum Continuous Power Rating. *Hence, it is recommended that for purposes of sizing the inverter to accommodate Crest Factor of 3, the Maximum Continuous Power Rating of the inverter should be > 2 times the Maximum Continuous Power Rating of the SMPS. For example, an SMPS rated at 100 Watts should be powered from an inverter that has Maximum Continuous Power Rating of > 200 Watts.*

SECTION 4 | Powering Direct / Embedded Switch Mode Power Supplies (SMPS)

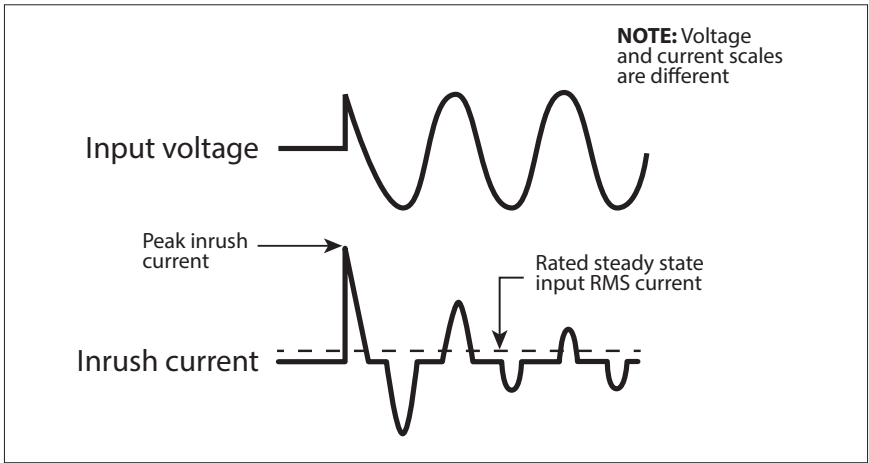

Fig 4.1: Inrush current in an SMPS

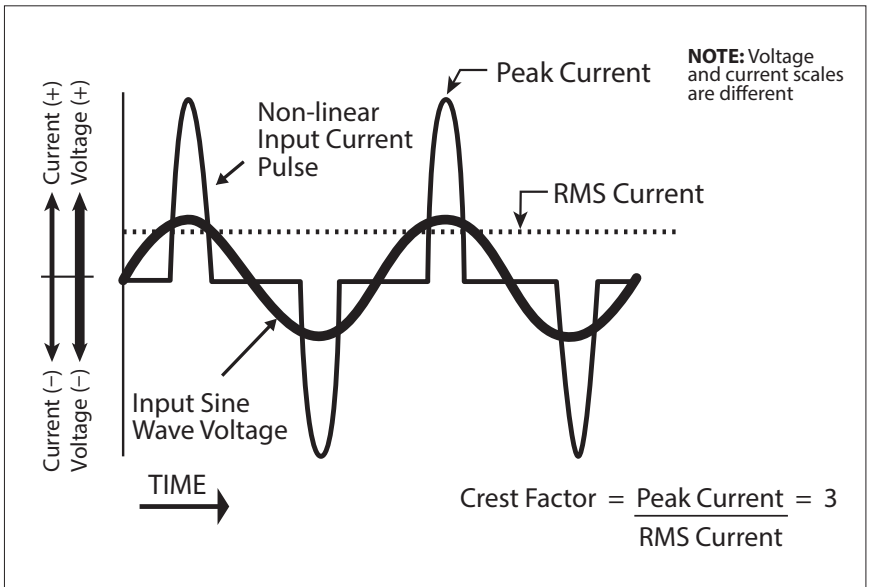

Fig. 4.2: High Crest Factor of current drawn by SMPS

SECTION 5 | Principle of Operation

5.1 GENERAL

These inverters convert DC battery voltage to AC voltage with an RMS (Root Mean Square) value of 230 VAC, 50/60 Hz.

5.2 PURE SINE WAVE OUTPUT WAVEFORM

The waveform of the AC voltage is a pure Sine Waveform that is same as the waveform of Grid / Utility power (*Supplementary information on pure Sine Waveform and its advantages are discussed in Sections 2.2 to 2.4*).

Fig. 5.1 below specifies the characteristics of 230 VAC, 50 Hz/60 Hz pure Sine Waveform. The instantaneous value and polarity of the voltage varies cyclically with respect to time. For example, in one cycle in a 230 VAC, 50 Hz/60 Hz system, it slowly rises in the Positive direction from 0V to a peak Positive value " V_{peak} " = + 325.22V, slowly drops to 0V, changes the polarity to Negative direction and slowly increases in the Negative direction to a peak Negative value " V_{peak} " = - 325.22V and then slowly drops back to 0V. There are 50 such cycles in 1 sec in 50 Hz and 60 in 60 Hz. Cycles per second is called the "Frequency" and is also termed "Hertz (Hz)". The Time Period of 1 Cycle is 20.00 ms for 50 Hz and 16.66 ms for 60 Hz.

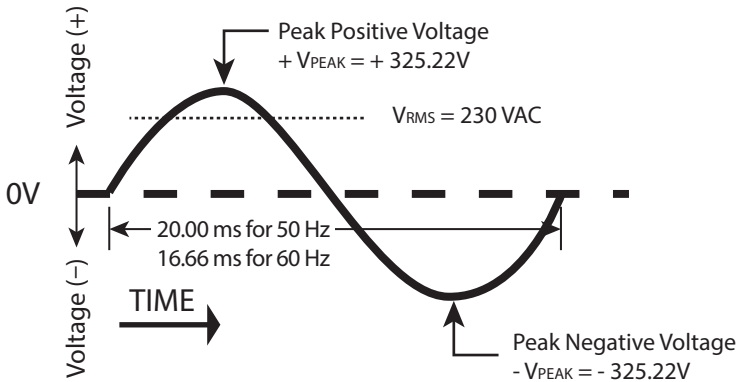

Fig. 5.1: 230 VAC, 50/60 Hz Pure Sine Waveform

5.3 PRINCIPLE OF OPERATION

The voltage conversion takes place in two stages. In the first stage, the DC voltage of the battery is converted to a high voltage DC using high frequency switching and Pulse Width Modulation (PWM) technique. In the second stage, the high voltage DC is converted to 230 VAC, 50/60 Hz sine wave AC again using PWM technique. This is done by using a special wave shaping technique where the high voltage DC is switched at a high frequency and the pulse width of this switching is modulated with respect to a reference sine wave.

SECTION 6 | Layout

6. LAYOUT

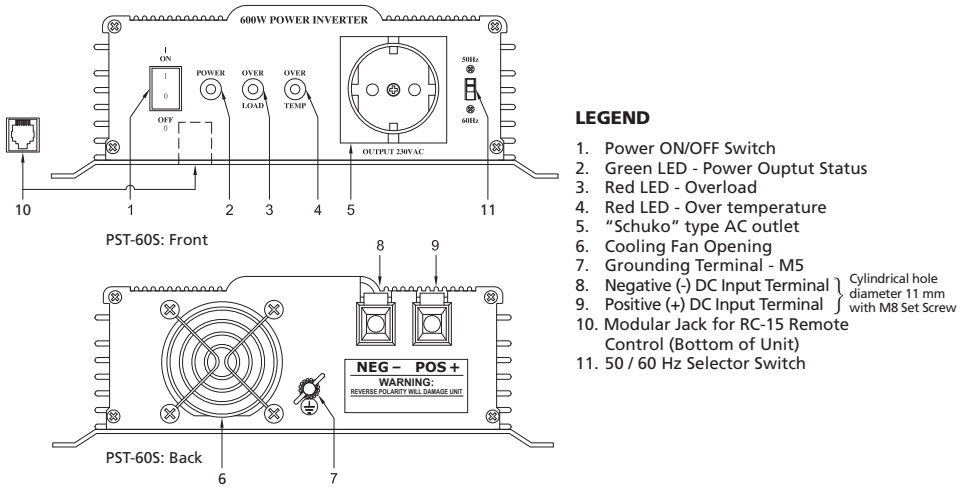

Fig. 6.1: Layout of PST-60S-12E, PST-60S-24E

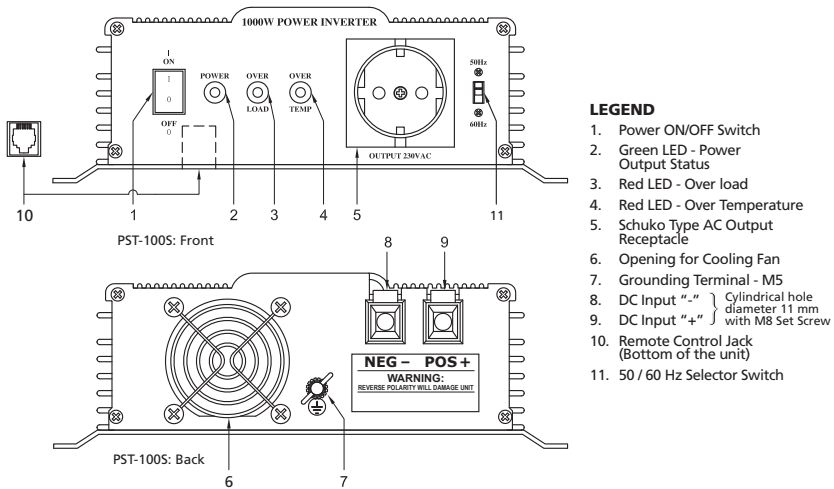

Fig. 6.2: Layout of PST-100S-12E, PST-100S-24E

SECTION 6 | Layout

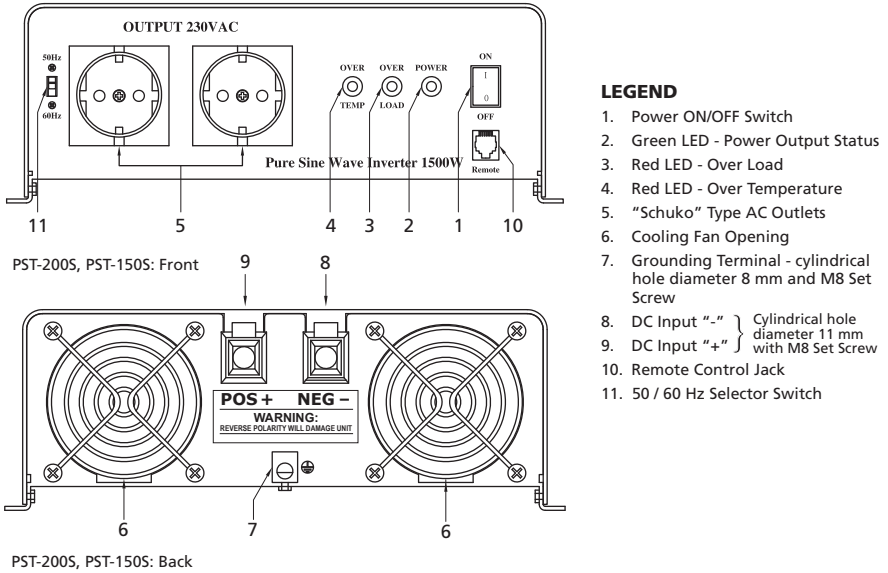

Fig. 6.3: Layout of PST-150S-12E, PST-150S-24E, PST-200S-12E, PST-200S-24E

SECTION 7 | General Information on Lead Acid Batteries

7.1 GENERAL



INFO

For complete background information on Lead Acid Batteries and charging process, please visit www.samlexamerica.com > support > white papers > White Paper - Batteries, Chargers and Alternators.

Lead-acid batteries can be categorized by the type of application:

1. Automotive service - Starting/Lighting/Ignition (SLI, a.k.a. cranking), and
2. Deep cycle service.

Deep Cycle Lead Acid Batteries of appropriate capacity are recommended for powering of inverters.

SECTION 7 | General Information on Lead Acid Batteries

7.2 DEEP CYCLE LEAD ACID BATTERIES

Deep cycle batteries are designed with thick-plate electrodes to serve as primary power sources, to have a constant discharge rate, to have the capability to be deeply discharged up to 80 % capacity and to repeatedly accept recharging. They are marketed for use in recreation vehicles (RV), boats and electric golf carts – so they may be referred to as RV batteries, marine batteries or golf cart batteries. Use Deep Cycle batteries for powering these inverters.

7.3 RATED CAPACITY SPECIFIED IN AMPERE-HOUR (Ah)

Battery capacity “C” is specified in Ampere-hours (Ah). An Ampere is the unit of measurement for electrical current and is defined as a Coulomb of charge passing through an electrical conductor in one second. The Capacity “C” in Ah relates to the ability of the battery to provide a constant specified value of discharge current (also called “C-Rate”: See Section 7.6) over a specified time in hours before the battery reaches a specified discharged terminal voltage (Also called “End Point Voltage”) at a specified temperature of the electrolyte. As a benchmark, the automotive battery industry rates batteries at a discharge current or C-Rate of C/20 Amperes corresponding to 20 Hour discharge period. The rated capacity “C” in Ah in this case will be the number of Amperes of current the battery can deliver for 20 Hours at 80°F (26.7°C) till the voltage drops to 1.75V / Cell. i.e. 10.5V for 12V battery, 21V for 24V battery and 42V for a 48V battery. For example, a 100 Ah battery will deliver 5A for 20 Hours.

7.4 RATED CAPACITY SPECIFIED IN RESERVE CAPACITY (RC)

Battery capacity may also be expressed as Reserve Capacity (RC) in minutes typically for automotive SLI (Starting, Lighting and Ignition) batteries. It is the time in minutes a vehicle can be driven after the charging system fails. This is roughly equivalent to the conditions after the alternator fails while the vehicle is being driven at night with the headlights on. The battery alone must supply current to the headlights and the computer/ignition system. The assumed battery load is a constant discharge current of 25A. Reserve capacity is the time in minutes for which the battery can deliver 25 Amperes at 80°F (26.7°C) till the voltage drops to 1.75V / Cell i.e. 10.5V for 12V battery, 21V for 24V battery and 42V for 48V battery.

Approximate relationship between the two units is:

$$\text{Capacity "C" in Ah} = \text{Reserve Capacity in RC minutes} \times 0.6$$

7.5 TYPICAL BATTERY SIZES

The Table 7.1 below shows details of some popular battery sizes:

BCI* Group	Battery Voltage, V	Battery Capacity, Ah
27 / 31	12	105
4D	12	160
8D	12	225
GC2**	6	220

* Battery Council International; ** Golf Cart

SECTION 7 | General Information on Lead Acid Batteries

7.6 SPECIFYING CHARGING / DISCHARGING CURRENTS: C-RATE

Electrical energy is stored in a cell / battery in the form of DC power. The value of the stored energy is related to the amount of the active materials pasted on the battery plates, the surface area of the plates and the amount of electrolyte covering the plates. As explained above, the amount of stored electrical energy is also called the Capacity of the battery and is designated by the symbol "C".

The time in Hours over which the battery is discharged to the "End Point Voltage" for purposes of specifying Ah capacity depends upon the type of application. Let us denote this discharge time in hours by "T". Let us denote the discharge current of the battery as the "C-Rate". If the battery delivers a very high discharge current, the battery will be discharged to the "End Point Voltage" in a shorter period of time. On the other hand, if the battery delivers a lower discharge current, the battery will be discharged to the "End Point Voltage" after a longer period of time. Mathematically:

EQUATION 1: Discharge current "C-Rate" = Capacity "C" in Ah ÷ Discharge Time "T"

Table 7.2 below gives some examples of C-Rate specifications and applications:

TABLE 7.2: DISCHARGE CURRENT RATES - "C-RATES"		
Hours of discharge time "T" till the "End Point Voltage"	"C-Rate" Discharge Current in Amps = Capacity "C" in Ah ÷ Discharge Time "T" in Hrs.	Example of C-Rate Discharge Currents for 100 Ah battery
0.5 Hrs.	2C	200A
1 Hrs.	1C	100A
5 Hrs. (Inverter application)	C/5 or 0.2C	20A
8 Hrs. (UPS application)	C/8 or 0.125C	12.5A
10 Hrs. (Telecom application)	C/10 or 0.1C	10A
20 Hrs. (Automotive application)	C/20 or 0.05C	5A
100 Hrs.	C/100 or 0.01C	1A

NOTE: When a battery is discharged over a shorter time, its specified "C-Rate" discharge current will be higher. For example, the "C-Rate" discharge current at 5 Hour discharge period i.e. C/5 Amps will be 4 times higher than the "C-Rate" discharge current at 20 Hour discharge period i.e. C/20 Amps.

7.7 CHARGING / DISCHARGING CURVES

Fig. 7.1 shows the charging and discharging characteristics of a typical 12V / 24V Lead Acid battery at electrolyte temperature of 80°F / 26.7°C. The curves show the % State of Charge (X-axis) versus terminal voltage (Y-axis) during charging and discharging at different C-Rates. **Please note that X-axis shows % State of Charge. State of Discharge will be = 100% - % State of Charge.** These curves will be referred to in the subsequent explanations.

SECTION 7 | General Information on Lead Acid Batteries

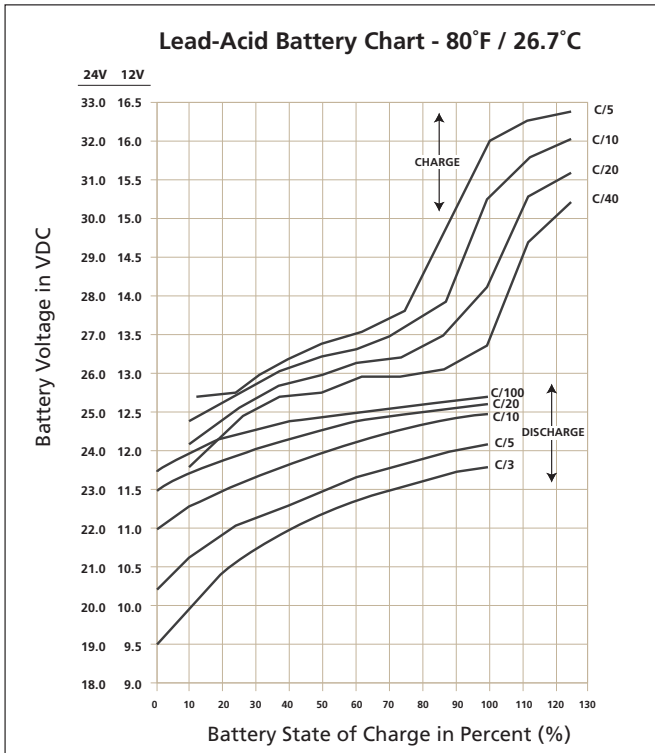

Fig. 7.1: Charging / Discharging Curves for 12V / 24V Lead Acid Battery

7.8 REDUCTION IN USABLE CAPACITY AT HIGHER DISCHARGE RATES – TYPICAL IN INVERTER APPLICATION

As stated above, the rated capacity of the battery in Ah is normally applicable at a discharge rate of 20 Hours. As the discharge rate is increased as in cases where the inverters are driving higher capacity loads, the usable capacity reduces due to “Peukert Effect”. This relationship is not linear but is more or less according to the Table 7.3.

TABLE 7.3 BATTERY CAPACITY VERSUS RATE OF DISCHARGE – C-RATE	
C-Rate Discharge Current	Usable Capacity (%)
C/20	100%
C/10	87%
C/8	83%

Table continues on the next page ►

SECTION 7 | General Information on Lead Acid Batteries

C-Rate Discharge Current	Usable Capacity (%)
C/6	75%
C/5	70%
C/3	60%
C/2	50%
1C	40%

Table 7.3 shows that a 100 Ah capacity battery will deliver 100% (i.e. full 100 Ah) capacity if it is slowly discharged over 20 Hours at the rate of 5 Amperes (50W output for a 12V inverter and 100W output for a 24V inverter). However, if it is discharged at a rate of 50 Amperes (500W output for a 12V inverter and 1000W output for a 24V inverter) then theoretically, it should provide $100 \text{ Ah} \div 50 = 2$ Hours. However, Table 7.3 shows that for 2 Hours discharge rate, the capacity is reduced to 50% i.e. 50 Ah. Therefore, at 50 Ampere discharge rate (500W output for a 12V inverter and 1000W output for a 24V inverter) the battery will actually last for $50 \text{ Ah} \div 50 \text{ Amperes} = 1$ Hour.

7.9 STATE OF CHARGE (SOC) OF A BATTERY – BASED ON “STANDING VOLTAGE”

The “Standing Voltage” of a battery under open circuit conditions (no load connected to it) can approximately indicate the State of Charge (SOC) of the battery. The “Standing Voltage” is measured after disconnecting any charging device(s) and the battery load(s) and letting the battery “stand” idle for 3 to 8 hours before the voltage measurement is taken. Table 7.4 shows the State of Charge versus Standing Voltage for a typical 12V/24V battery system at 80°F (26.7°C).

Percentage of Full Charge	Standing Voltage of Individual Cells	Standing Voltage of 12V Battery	Standing Voltage of 24V Battery
100%	2.105V	12.63V	25.26V
90%	2.10V	12.6V	25.20V
80%	2.08V	12.5V	25.00V
70%	2.05V	12.3V	24.60V
60%	2.03V	12.2V	24.40V
50%	2.02V	12.1V	24.20V
30%	1.97V	11.8V	23.60V
20%	1.95V	11.7V	23.40V
10%	1.93V	11.6V	23.20V
0%	= / < 1.93V	= / < 11.6V	= / < 23.20V

SECTION 7 | General Information on Lead Acid Batteries

Check the individual cell voltages / specific gravity. If the inter cell voltage difference is more than a 0.2V, or the specific gravity difference is 0.015 or more, the cells will require equalization. **Please note that only the non-sealed / vented / flooded / wet cell batteries are equalized. Do not equalize sealed / VRLA type of AGM or Gel Cell Batteries.**

7.10 STATE OF DISCHARGE OF A LOADED BATTERY – LOW BATTERY / DC INPUT VOLTAGE ALARM AND SHUTDOWN IN INVERTERS

Most inverter hardware estimate the State of Discharge of the loaded battery by measuring the voltage at the inverter's DC input terminals (considering that the DC input cables are thick enough to allow a negligible voltage drop between the battery and the inverter).

Inverters are provided with a buzzer alarm to warn that the loaded battery has been deeply discharged to around 80% of the rated capacity. **Normally, the buzzer alarm is triggered when the voltage at the DC input terminals of the inverter has dropped to around 10.5V for a 12V battery or 21V for 24V battery at C-Rate discharge current of C/5 Amps and electrolyte temp. of 80°F.** The inverter is shut down if the terminal voltage at C/5 discharge current falls further to 10V for 12V battery (20V for 24V battery).

The State of Discharge of a battery is estimated based on the measured terminal voltage of the battery. The terminal voltage of the battery is dependent upon the following:

- **Temperature of the battery electrolyte:** Temperature of the electrolyte affects the electrochemical reactions inside the battery and produces a Negative Voltage Coefficient – during charging / discharging, the terminal voltage drops with rise in temperature and rises with drop in temperature.
- **The amount of discharging current or "C-Rate":** A battery has non linear internal resistance and hence, as the discharge current increases, the battery terminal voltage decreases non-linearly.

The discharge curves in Fig. 7.1 show the % State of Charge versus the terminal voltage of typical battery under different charge /discharge currents, i.e. "C-Rates" and fixed temperature of 80°F.

NOTE: The X-Axis of the curves shown in Fig 7.1 indicates the percentage State of Charge. % State of Discharge should be converted to % State of Charge using the formula given below:

- % State of Charge = 100% - % State of Discharge

7.11 LOW DC INPUT VOLTAGE ALARM IN INVERTERS

As stated earlier, the buzzer alarm is triggered when the voltage at the DC input terminals of the inverter has dropped to around 10.5V for a 12V battery (21V for 24V battery) at C-Rate discharge current of C/5 Amps. Please note that the terminal voltage relative to a particular of State Discharge decreases with the rise in the value of the discharge current. For example, terminal voltages for a State of Discharge of 80% (State of Charge of 20%) for various discharge currents will be as given at Table 7.5 (Refer to Fig 7.1 for parameters and values shown in Table 7.5):

SECTION 7 | General Information on Lead Acid Batteries

TABLE 7.5 TERMINAL VOLTAGE AND SOC OF LOADED BATTERY

Discharge Current: C-Rate	Terminal Voltage at 80% State of Discharge (20% SOC)		Terminal Voltage When Completely Discharged (0% SOC)	
	12V	24V	12V	24V
	C/3 A	10.45V	20.9V	09.50V
C/5 A	10.90V	21.8V	10.30V	20.6V
C/10 A	11.95V	23.9V	11.00V	22.0V
C/20 A	11.85V	23.7V	11.50V	23.0V
C/100 A	12.15V	24.3V	11.75V	23.5V

In the example given above, the 10.5V / 21.0V Low Battery / DC Input Alarm would trigger at around 80% discharged state (20% SOC) when the C-Rate discharge current is C/5 Amps. However, for lower C-Rate discharge current of C/10 Amps and lower, the battery will be almost completely discharged when the alarm is sounded. ***Hence, if the C-Rate discharge current is lower than C/5 Amps, the battery may have completely discharged by the time the Low DC Input Alarm is sounded.***

7.12 LOW DC INPUT VOLTAGE SHUT-DOWN IN INVERTERS

As explained above, at around 80% State of Discharge of the battery at C-Rate discharge current of around C/5 Amps, the Low DC Input Voltage Alarm is sounded at around 10.5V for a 12V battery (at around 21V for 24V battery) to warn the user to disconnect the battery to prevent further draining of the battery. If the load is not disconnected at this stage, the batteries will be drained further to a lower voltage and to a completely discharged condition that is harmful for the battery and for the inverter.

Inverters are normally provided with a protection to shut down the output of the inverter if the DC voltage at the input terminals of the inverter drops below a threshold of around 10V for a 12V battery (20V for 24V battery). Referring to the Discharge Curves given in Fig 7.1, the State of Discharge for various C-Rate discharge currents for battery voltage of 10V / 20V is as follows: (Please note that the X-Axis of the curves shows the % of State of Charge. The % State of Discharge has to be converted to the % State of Charge using the formula: % State of Charge = 100% - % State of Discharge):

- 85% State of Discharge (15% State of Charge) at very high C-rate discharge current of C/3 Amps.
- 100% State of Discharge (0 % State of Charge) at high C-Rate discharge current of C/5 Amps.
- 100% discharged (0% State of charge) at lower C-rate Discharge current of C/10 Amps.

It is seen that at DC input voltage of 10V / 20V, the battery is completely discharged for C-rate discharge current of C/5 and lower.

SECTION 7 | General Information on Lead Acid Batteries

In view of the above, it may be seen that a fixed Low DC Input Voltage Alarm is not useful.

Temperature of the battery further complicates the situation. All the above analysis is based on battery electrolyte temperature of 80°F. The battery capacity varies with temperature. Battery capacity is also a function of age and charging history. Older batteries have lower capacity because of shedding of active materials, sulfation, corrosion, increasing number of charge / discharge cycles etc. Hence, the State of Discharge of a battery under load cannot be estimated accurately. However, the low DC input voltage alarm and shut-down functions are designed to protect the inverter from excessive current drawn at the lower voltage.

7.13 USE OF EXTERNAL PROGRAMMABLE LOW VOLTAGE DISCONNECTS

The above ambiguity can be removed by using an external, programmable Low Voltage Disconnect where more exact voltage threshold can be set to disconnect the battery based on the actual application requirements. Please consider using the following Programmable Low Battery Cut-off / "Battery Guard" Models manufactured by Samlex America, Inc. www.samlexamerica.com

- BG-40 (40A) – For up to 400W, 12V inverter or 800W, 24V inverter
- BG-60 (60A) - For up to 600W, 12V inverter or 1200W, 24V inverter
- BG-200 (200A) - For up to 2000W, 12V inverter or 4000W, 24V inverter

7.14 DEPTH OF DISCHARGE OF BATTERY AND BATTERY LIFE

The more deeply a battery is discharged on each cycle, the shorter the battery life. Using more batteries than the minimum required will result in longer life for the battery bank. A typical cycle life chart is given in the Table 7.6:

Depth of Discharge % of Ah Capacity	Cycle Life of Group 27 /31	Cycle Life of Group 8D	Cycle Life of Group GC2
10	1000	1500	3800
50	320	480	1100
80	200	300	675
100	150	225	550

NOTE: It is recommended that the depth of discharge should be limited to 50%.

SECTION 7 | General Information on Lead Acid Batteries

7.15 SERIES AND PARALLEL CONNECTION OF BATTERIES

7.15.1 Series Connection

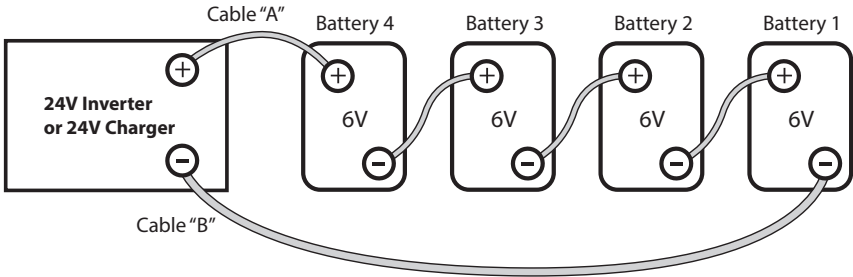

Fig 7.2: Series Connection

When two or more batteries are connected in series, their voltages add up but their Ah capacity remains the same. Fig. 7.2 shows 4 pieces of 6V, 200 Ah batteries connected in series to form a battery bank of 24V with a capacity of 200 Ah. The Positive terminal of Battery 4 becomes the Positive terminal of the 24V bank. The Negative terminal of Battery 4 is connected to the Positive terminal of Battery 3. The Negative terminal of Battery 3 is connected to the Positive terminal of Battery 2. The Negative terminal of Battery 2 is connected to the Positive terminal of Battery 1. The Negative terminal of Battery 1 becomes the Negative terminal of the 24V battery bank.

7.15.2 Parallel Connection

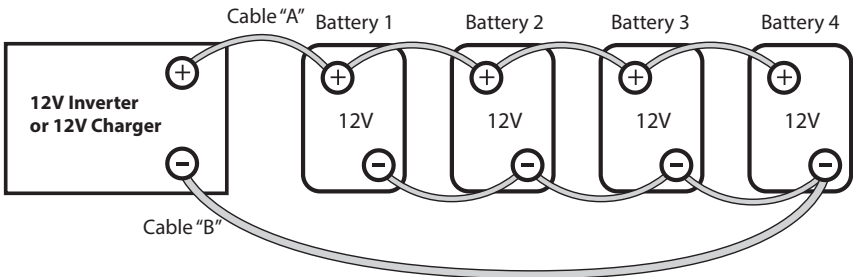

Fig 7.3: Parallel Connection

When two or more batteries are connected in parallel, their voltage remains the same but their Ah capacities add up. Fig. 7.3 shows 4 pieces of 12V, 100 Ah batteries connected in parallel to form a battery bank of 12V with a capacity of 400 Ah. The four Positive terminals of Batteries 1 to 4 are paralleled (connected together) and this common Positive connection becomes the Positive terminal of the 12V bank. Similarly, the four Negative terminals of Batteries 1 to 4 are paralleled (connected together) and this common Negative connection becomes the Negative terminal of the 12V battery bank.

SECTION 7 | General Information on Lead Acid Batteries

7.15.3 Series – Parallel Connection

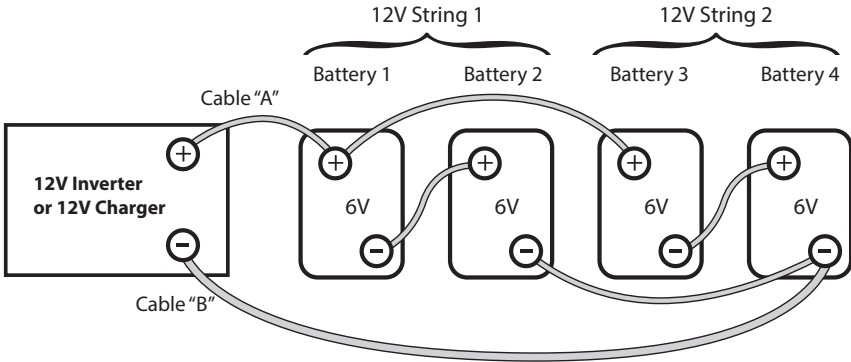

Fig. 7.4: Series-Parallel Connection

Figure 7.4 shows a series – parallel connection consisting of four 6V, 200 AH batteries to form a 12V, 400 Ah battery bank. Two 6V, 200 Ah batteries, Batteries 1 and 2 are connected in series to form a 12V, 200 Ah battery (String 1). Similarly, two 6V, 200 Ah batteries, Batteries 3 and 4 are connected in series to form a 12V, 200 Ah battery (String 2). These two 12V, 200 Ah Strings 1 and 2 are connected in parallel to form a 12V, 400 Ah bank.



CAUTION!

When 2 or more batteries / battery strings are connected in parallel and are then connected to an inverter or charger (See Figs 7.3 and 7.4), attention should be paid to the manner in which the charger / inverter is connected to the battery bank. Please ensure that if the Positive output cable of the battery charger / inverter (Cable "A") is connected to the Positive battery post of the first battery (Battery 1 in Fig 7.3) or to the Positive battery post of the first battery string (Battery 1 of String 1 in Fig. 7.4), then the Negative output cable of the battery charger / inverter (Cable "B") should be connected to the Negative battery post of the last battery (Battery 4 as in Fig. 7.3) or to the Negative Post of the last battery string (Battery 4 of Battery String 2 as in Fig. 7.4). This connection ensures the following:

- The resistances of the interconnecting cables will be balanced.
- All the individual batteries / battery strings will see the same series resistance.
- All the individual batteries will charge / discharge at the same charging current and thus, will be charged to the same state at the same time.
- None of the batteries will see an overcharge condition.

SECTION 7 | General Information on Lead Acid Batteries

7.16 SIZING THE INVERTER BATTERY BANK

One of the most frequently asked questions is, "how long will the batteries last?" This question cannot be answered without knowing the size of the battery system and the load on the inverter. Usually this question is turned around to ask "How long do you want your load to run?", and then specific calculation can be done to determine the proper battery bank size.

There are a few basic formulae and estimation rules that are used:

1. Active Power in Watts (W) = Voltage in Volts (V) x Current in Amperes (A) x Power Factor.
2. For an inverter running from a 12V battery system, the approximate DC current required from the 12V batteries is the AC power delivered by the inverter to the load in Watts (W) divided by 10 & for an inverter running from a 24V battery system, the approximate DC current required from the 24V batteries is the AC power delivered by the inverter to the load in Watts (W) divided by 20.
3. Energy required from the battery = DC current to be delivered (A) x Time in Hours (H).

The first step is to estimate the total AC Watts (W) of load(s) and for how long the load(s) will operate in hours (H). The AC Watts are normally indicated in the electrical nameplate for each appliance or equipment. In case AC Watts (W) are not indicated, Formula 1 given above may be used to calculate the AC Watts. The next step is to estimate the DC current in Amperes (A) from the AC Watts as per Formula 2 above. An example of this calculation for a 12V inverter is given below:

Let us say that the total AC Watts delivered by the inverter = 1000W.

Then, using Formula 2 above, the approximate DC current to be delivered by the 12V batteries = $1000W \div 10 = 100$ Amperes, or by 24V batteries = $1000W \div 20 = 50A$.

Next, the energy required by the load in Ampere Hours (Ah) is determined.

For example, if the load is to operate for 3 hours then as per Formula 3 above, the energy to be delivered by the 12V batteries = $100 \text{ Amperes} \times 3 \text{ Hours} = 300$ Ampere Hours (Ah), or by the 24V batteries = $50A \times 3 \text{ Hrs} = 150 \text{ Ah}$.

Now, the capacity of the batteries is determined based on the run time and the usable capacity.

From Table 7.3 "Battery Capacity versus Rate of Discharge", the usable capacity at 3 Hour discharge rate is 60%. Hence, the actual capacity of the 12V batteries to deliver 300 Ah will be equal to: $300 \text{ Ah} \div 0.6 = 500 \text{ Ah}$, and the actual capacity of the 24V battery to deliver 150 Ah will be equal to $150 \text{ Ah} \div 0.6 = 250 \text{ Ah}$.

And finally, the actual desired rated capacity of the batteries is determined based on the fact that normally only 80% of the capacity will be available with respect to the rated capacity due to non availability of ideal and optimum operating and charging conditions. So the final requirements will be equal to:

SECTION 7 | General Information on Lead Acid Batteries

FOR 12V BATTERY:

$500 \text{ Ah} \div 0.8 = 625 \text{ Ah}$ (note that the actual energy required by the load was 300 Ah).

FOR 24V BATTERY:

$250 \text{ Ah} \div 0.8 = 312.5 \text{ Ah}$ (Note that the actual energy required was 150 Ah).

It will be seen from the above that the final rated capacity of the batteries is almost 2 times the energy required by the load in Ah. ***Thus, as a Rule of Thumb, the Ah capacity of the batteries should be twice the energy required by the load in Ah.***

7.17 CHARGING BATTERIES

Batteries can be charged by using good quality AC powered battery charger or from alternative energy sources like solar panels, wind or hydro systems. Make sure an appropriate Battery Charge Controller is used. It is recommended that batteries may be charged at 10% to 13% of their Ah capacity (Ah capacity based on C-Rate of 20 Hr Discharge Time). Also, for complete charging (return of 100% capacity) of Sealed Lead Acid Battery, it is recommended that a 3 Stage Charger may be used (Constant Current Bulk Charging Stage ▶ Constant Voltage Boost / Absorption Charging ▶ Constant Voltage Float Charging).

In case, Wet Cell / Flooded Batteries are being used, a 4-stage charger is recommended (Constant Current Bulk Charging Stage ▶ Constant Voltage Boost / Absorption Stage ▶ Constant Voltage Equalization Stage ▶ Constant Voltage Float Stage).

SECTION 8 | Installation



WARNING!

1. Before commencing installation, please read the safety instructions explained in Section 1 titled "Safety Instructions".
2. It is recommended that the installation should be undertaken by a qualified, licensed / certified electrician.
3. Various recommendations made in this manual on installation will be superseded by the National / Local Electrical Codes related to the location of the unit and the specific application.

8.1 LOCATION OF INSTALLATION

Please ensure that the following requirements are met:

Working Environment: Indoor use.

SECTION 8 | Installation

Cool: Heat is the worst enemy of electronic equipment. Hence, please ensure that the unit is installed in a cool area that is also protected against heating effects of direct exposure to the sun or to the heat generated by other adjacent heat generating devices.

Well Ventilated: The unit is cooled by convection and by forced air-cooling by temperature controlled fan. The fan draws cool air from air intake openings on the front (5, Fig 6.1a) and expels hot air through the exhaust openings next to the fan (18, Fig 6.1c). To avoid shut down of the inverter due to over temperature, do not cover or block these intake / exhaust openings or install the unit in an area with limited airflow. Keep a minimum clearance of 10" around the unit to provide adequate ventilation. If installed in an enclosure, openings must be provided in the enclosure, directly opposite to the air intake and exhaust openings of the inverter.

Dry: There should be no risk of condensation, water or any other liquid that can enter or fall on the unit.

Clean: The area should be free of dust and fumes. Ensure that there are no insects or rodents. They may enter the unit and block the ventilation openings or short circuit electrical circuits inside the unit.

Protection Against Fire Hazard: The unit is not ignition protected and should not be located under any circumstance in an area that contains highly flammable liquids like gasoline or propane as in an engine compartment with gasoline-fueled engines. Do not keep any flammable / combustible material (i.e., paper, cloth, plastic, etc.) near the unit that may be ignited by heat, sparks or flames.

Closeness to the Battery Bank: Locate the unit as close to the battery bank as possible to prevent excessive voltage drop in the battery cables and consequent power loss and reduced efficiency. However, the unit should not be installed in the same compartment as the batteries (flooded or wet cell) or mounted where it will be exposed to corrosive acid fumes and flammable Oxygen and Hydrogen gases produced when the batteries are charged. The corrosive fumes will corrode and damage the unit and if the gases are not ventilated but allowed to collect, they could ignite and cause an explosion.

Accessibility: Do not block access to the front panel. Also, allow enough room to access the AC receptacles and DC wiring terminals and connections, as they will need to be checked and tightened periodically.

Preventing Electro Magnetic Interference (EMI): The unit uses high power switching circuits that generate RFI. This RFI is limited to the required standards. Locate any electronic equipment susceptible to radio frequency and electromagnetic interference as far away from the inverter as possible. *Read Section 3 "EMC (EMI/EMS) Compliance" for additional information.*

8.2 OVERALL DIMENSIONS

The overall dimensions and the location of the mounting slots are shown in Fig. 8.1 to 8.3 on next page.

SECTION 8 | Installation

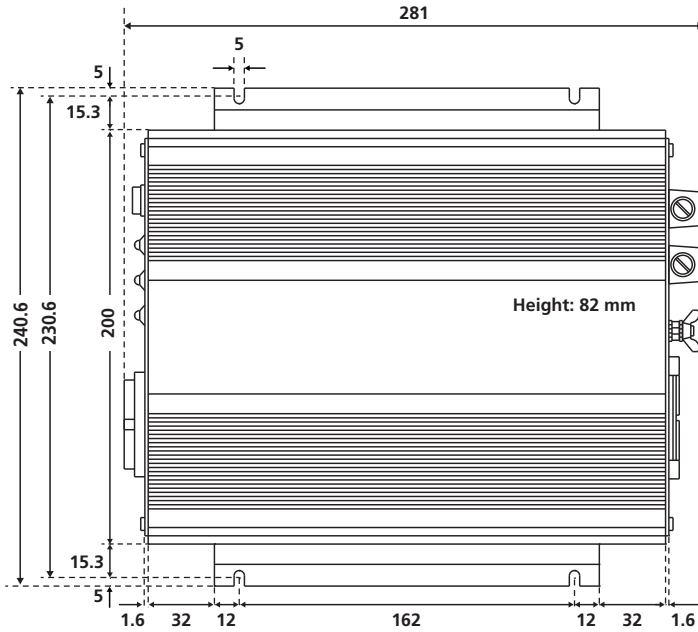

Fig. 8.1: PST-60S-12E, PST-60S-24E Dimensions and Mounting Slots / Dimensions (mm): 281 x 241 x 82

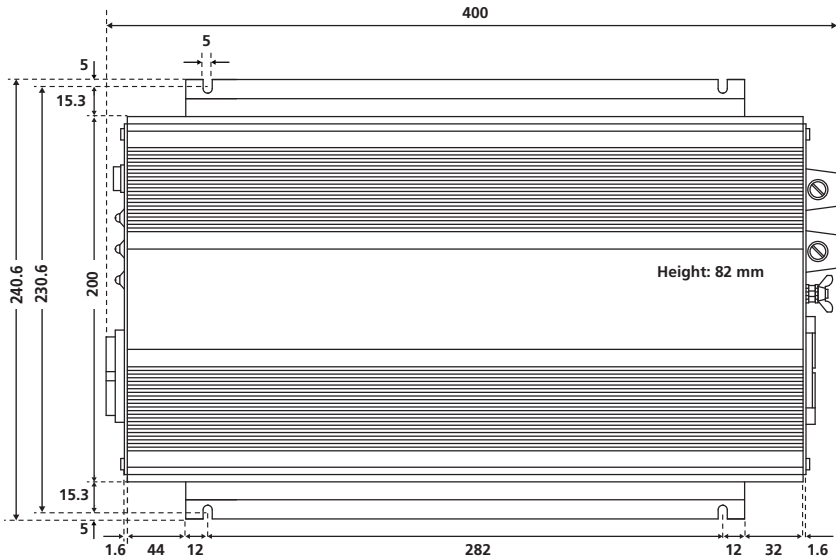

Fig. 8.2: PST-100S-12E, PST-100S-24E Dimensions and Mounting Slots / Dimensions (mm): 240.6 x 400 x 82

SECTION 8 | Installation

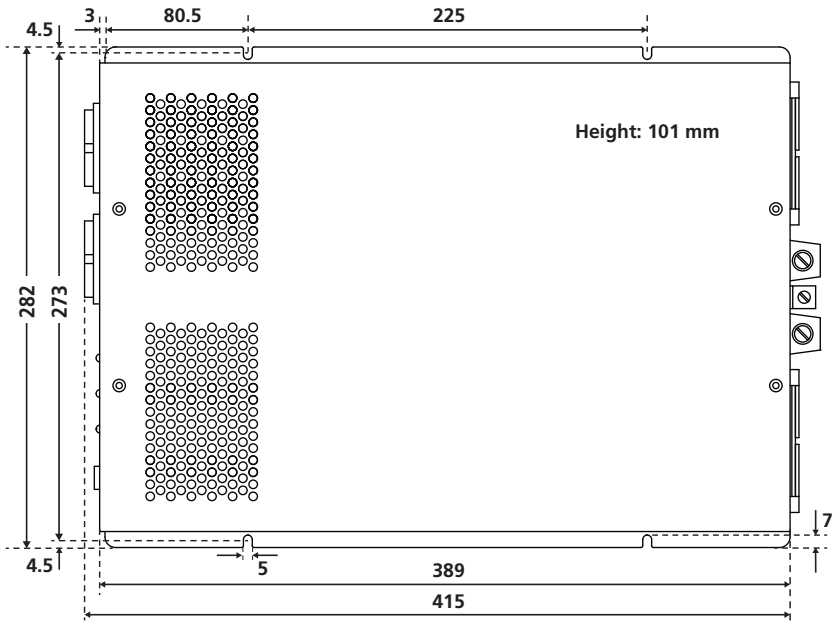

Fig. 8.3: Dimensions and Mounting Slots for PST-150S-12E, PST-150S-24E and PST-200S-12E, PST-200S-24E / Dimensions (mm): 282 x 415 x 101

8.3 MOUNTING ORIENTATION

The unit has air intake and exhaust openings for the cooling fan. It has to be mounted in such a manner so that small objects should not be able to fall easily into the unit from these openings and cause electrical / mechanical damage. Also, the mounting orientation should be such that if the internal components overheat and melt / dislodge due to a catastrophic failure, the melted / hot dislodged portions should not be able to fall out of the unit on to a combustible material and cause a fire hazard. The size of openings has been limited as per the safety requirements to prevent the above possibilities when the unit is mounted in the recommended orientations. In order to meet the regulatory safety requirements, the mounting has to satisfy the following requirements:

- Mount on a non-combustible material.
- The mounting surface should be able to support the weight of the unit
- Mount horizontally on a horizontal surface - above a horizontal surface (e.g. table top or a shelf).
- Mount horizontally on a vertical surface – The unit can be mounted on a vertical surface (like a wall) with the fan axis horizontal (fan opening facing left or right).

SECTION 8 | Installation



WARNING!

Mounting the unit vertically on a vertical surface is NOT recommended (fan opening facing up or down). As explained above, this is to prevent falling of objects into the unit through the fan opening when the fan opening faces up. If fan opening faces down, hot damaged component may fall out.

The surface of the unit is likely to be at an elevated temperature in conditions of higher load and higher ambient temperature. Hence, the unit should be installed in a manner where it is not likely to come in contact with any person.

8.4 DC SIDE CONNECTIONS

8.4.1 Preventing DC Input Over Voltage

It is to be ensured that the DC input voltage of this unit does not exceed 16.5 VDC for the 12V versions and 33.0 VDC for the 24V versions to prevent permanent damage to the unit. Please observe the following precautions:

- Ensure that the maximum charging voltage of the external battery charger / alternator / solar charge controller does not exceed 16.5 VDC for the 12V versions and 33.0 VDC for the 24V versions
- Do not use unregulated solar panels to charge the battery connected to this unit. Under open circuit conditions and in cold ambient temperatures, the output of the solar panel may be > 22 VDC for 12V nominal panel and > 44V for 24V nominal panel. Always use a charge controller between the solar panel and the battery.
- When using Diversion Charge Control Mode in a charge controller, the solar / wind / hydro source is directly connected to the battery bank. In this case, the controller will divert excess current to an external load. As the battery charges, the diversion duty cycle will increase. When the battery is fully charged, all the source energy will flow into the diversion load if there are no other loads. The charge controller will disconnect the diversion load if the current rating of the controller is exceeded. Disconnection of the diversion load may damage the battery as well as the inverter or other DC loads connected to the battery due to high voltages generated during conditions of high winds (for wind generators), high water flow rates (for hydro generators). It is, therefore, to be ensured that the diversion load is sized correctly to prevent the above over voltage conditions.
- Do not connect this unit to a battery system with a voltage higher than the rated battery input voltage of the unit (e.g. do not connect the 12V versions to 24V or 48V Battery System or the 24V versions to 48V Battery System).

8.4.2 Preventing Reverse Polarity on the DC Input Side



CAUTION!

Damage caused by reverse polarity is not covered by warranty! When making battery connections on the input side, make sure that the polarity of battery connections is correct (Connect the Positive of the battery to the Positive termi-

SECTION 8 | Installation

nal of the unit and the Negative of the battery to the Negative terminal of the unit). If the input is connected in reverse polarity, DC fuse(s) inside the inverter will blow and may also cause permanent damage to the inverter.

8.4.3 Connection from Batteries to the DC Input Side – Sizing of Cables and Fuses



CAUTION!

The input section of the inverter has large value capacitors connected across the input terminals. As soon as the DC input connection loop (Battery (+) terminal → External Fuse → Positive input terminal → Negative input terminal → Battery (-) terminal) is completed, these capacitors will start charging and the unit will **momentarily** draw very heavy current to charge these capacitors that will produce sparking on the last contact in the input loop even when the unit is in OFF condition. Ensure that the fuse is inserted only after all the connections in the loop have been completed so that sparking is limited to the fuse area.

Flow of electric current in a conductor is opposed by the resistance of the conductor. The resistance of the conductor is directly proportional to the length of the conductor and inversely proportional to its cross-section (thickness). The resistance in the conductor produces undesirable effects of voltage drop and heating. The size (thickness / cross-section) of the conductors is specified in mm² or in AWG (American Wire Gauge). Conductors thicker than AWG #4/0 are sized in MCM/kcmil. Table 8.1 below gives Resistance in Ohm (Ω) per Foot at 25°C / 77°F for the wire sizing recommended for use with this inverter.

WIRE SIZE, AWG	RESISTANCE IN OHM (Ω) PER FOOT AT 25°C / 77°F
16 mm ² / AWG#6	0.000403 Ω / ft
25 mm ² / AWG#4	0.000253 Ω / ft
35 mm ² / AWG#2	0.000159 Ω / ft
50 mm ² / AWG#1/0	0.000100 Ω / ft
70 mm ² / AWG#2/0	0.000079 Ω / ft
95 mm ² / AWG#3/0	0.000063 Ω / ft
120 mm ² / AWG#4/0	0.000049 Ω / ft

Conductors are protected with insulating material rated for specific temperature e.g. 90°C/194°F. As current flow produces heat that affects insulation, there is a maximum permissible value of current (called "Ampacity") for each size of conductor based on temperature rating of its insulation. The insulating material of the cables will also be affected by the elevated operating temperature of the terminals to which these are connected. Ampacity of cables is based on guidelines given under "Notes for Table 8.2".

SECTION 8 | Installation

The DC input circuit is required to handle very large DC currents and hence, the size of the cables and connectors should be selected to ensure minimum voltage drop between the battery and the inverter. Thinner cables and loose connections will result in poor inverter performance and will produce abnormal heating leading to risk of insulation melt down and fire. Normally, the thickness of the cable should be such that the voltage drop due to the current & the resistance of the length of the cable should be less than 2% to 5%. Use oil resistant, multi-stranded copper wire cables rated at 90°C / 194°F minimum. Do not use aluminum cable as it has higher resistance per unit length. Cables can be bought at a marine / welding supply store. Effects of low voltage on common electrical loads are given below:

- **Lighting circuits** - incandescent and Quartz Halogen: A 5% voltage drop causes an approximate 10% loss in light output. This is because the bulb not only receives less power, but the cooler filament drops from white-hot towards red-hot, emitting much less visible light.
- **Lighting circuits** - fluorescent: Voltage drop causes a nearly proportional drop in light output.
- **AC induction motors** - These are commonly found in power tools, appliances, well pumps etc. They exhibit very high surge demands when starting. Significant voltage drop in these circuits may cause failure to start and possible motor damage.
- **PV battery charging circuits** - These are critical because voltage drop can cause a disproportionate loss of charge current to charge a battery. A voltage drop greater than 5% can reduce charge current to the battery by a much greater percentage.

8.4.4 Fuse Protection in the Battery Circuit

A battery is an **unlimited** source of current. Under short circuit conditions, a battery can supply thousands of Amperes of current. If there is a short circuit along the length of the cables that connects the battery to the inverter, thousands of Amperes of current can flow from the battery to the point of shorting and that section of the cable will become red-hot, the insulation will melt and the cable will ultimately break. This interruption of very high current will generate a hazardous, high temperature, high-energy arc with accompanying high-pressure wave that may cause fire, damage nearby objects and cause injury. To prevent occurrence of hazardous conditions under short circuit conditions, the fuse used in the battery circuit should limit the current (should be "Current Limiting Type"), blow in a very short time (should be Fast Blow Type) and at the same time, quench the arc in a safe manner. For this purpose, fuse Type UL Class-T (as per UL standard UL 248-15) / Type "HRC" (as per BS88-2 or as per IEC 60269-2) should be used. This special purpose current limiting, very fast acting fuse will blow in less than 8 ms under short circuit conditions. **Appropriate capacity of the above fuse or equivalent should be installed within 7" of the battery Plus (+) Terminal** (Please see Table 8.2 for fuse sizing). Marine Rated Battery Fuses, MRBF-xxx Series made by Cooper Bussmann may also be used. These fuses comply with ISO 8820-6 for road vehicles.

SECTION 8 | Installation



WARNING!

Use of an appropriately sized external fuse as described above is **mandatory** to provide safety against fire hazard due to accidental short circuit in the battery cables. Please note that the internal DC side fuses are designed to protect the internal components of the inverter against DC side overloading. These fuses will **NOT** blow if there is a short circuit along the length of wires connecting the battery and the inverter.

8.4.5 Recommended Sizes of Battery Cables and Fuses

Sizes of cables and fuses are shown in Table 8.2. Sizing is based on safety considerations specified in British Standard BS 7671. Please refer to "Notes for Table 8.2" for details.

Item (Column 1)	Rated continuous DC input current (See Note 1) (Column 2)	Size of external fuse based on DC input current at Column 2 (See Note 2) (Column 3)	90°C / 194°F Copper conductor. Size based on Ampacity at Column (3) or 2% voltage drop, whichever is thicker (See Note 3)	
			Cable Running Distance between the Unit and the Battery (Cable Routing In Free Air)	
			Up to 5 ft. (Column 5)	Up to 10 ft. (Column 6)
PST-60S-12E	80A	80A	25 mm ² / AWG#4	50 mm ² / AWG#1/0
PST-60S-24E	40A	40A	6 mm ² / AWG#10	16 mm ² / AWG#6
PST-100S-12E	160A	175A	50 mm ² / AWG1/0	95 mm ² / AWG#3/0
PST-100S-24E	80A	80A	16 mm ² / AWG#6	25 mm ² / AWG#4
PST-150S-12E	200A	200A	50 mm ² / AWG#1/0	95 mm ² / AWG#3/0
PST-150S-24E	100A	100A	16 mm ² / AWG#6	35 mm ² / AWG#2
PST-200S-12E	240A	250A	50 mm ² / AWG#1/0	120 mm ² / AWG#4/0
PST-200S-24E	120A	125A	25 mm ² / AWG#4	35 mm ² / AWG#2

NOTES FOR TABLE 8.2 - SIZING OF BATTERY SIDE CABLES AND EXTERNAL BATTERY SIDE FUSES

- 1) Column 2 indicates the Rated Continuous DC Input Current drawn from the battery.
- 2) Column 3 indicates size of external fuse not less than the Rated DC Input Current at Column 2. Next standard capacity is to be used.
- 3) Columns 5 and 6 indicate cable conductor size that is based on the following 2 considerations. Thicker conductor out of the following 2 considerations has been chosen:
 - a) As per guidelines in British Standard BS 7671 - Table 4E 1A (Reference Method "C" for 2 cables). Following have been considered: (i) Ampacity = the fuse size at Column 3, (ii) Copper conductor with temperature rating

SECTION 8 | Installation

- of 90°C / 194°F, (iii) Ambient temperature of 30°C / 86°F and (iv) Fixed on (clipped direct) or spaced less than 0.3x cable diameter from wooden or masonry wall.
- b) Voltage drop across the length of cables has been limited to 2% of 12V / 24V. Voltage drop has been calculated by multiplying the Rated DC Input Current (Column 2) and the resistance of the total length of Copper conductor (the total length of conductor has been taken as 2 times the running distance between the unit and the battery to cover 2 lengths of Positive and Negative cable conductors).
- 4) Column 3 indicates the size of external fuse in the battery circuit. It is mandatory to install this fuse within 7" of the battery Positive terminal to protect the battery cables against short circuit. Amp rating of the fuse is based on the following considerations:
- a) Not less than the Rated Continuous DC Input Current (Column 2)
 - b) Closest Standard Ampere Rating of Fuse has been used
 - c) Type of fuse: Fast-acting, Current Limiting, UL Class – Type "Class T" as per UL Standard 248-15 or Type "HRC" as per BS 88-2 / IEC60269-2

8.4.6 DC Input Terminals for Battery Connection

The DC input terminals for battery connection (8 and 9 in Figs 6.1, 6.2, 6.3) have 11 mm cylindrical hole with M8 set screw.

8.4.7 Using proper wiring termination

The battery end and the inverter end of the DC input wiring should have proper terminals that will ensure a firm and tight connection.

Terminal lugs have been provided to suit recommended cable sizes as per Column 5 of Table 8.2.

8.4.8 Reducing RF Interference

Please comply with recommendations given in Section 3 - "EMC (EMI / EMS) Compliance".

8.5 AC SIDE CONNECTIONS



WARNING! Preventing Paralleling of the AC Output

1. The AC output of the inverter cannot be synchronized with another AC source and hence, it is not suitable for paralleling. The AC output of the inverter should never be connected directly to an electrical breaker panel / load center which is also fed from the utility power/ generator. Such a connection will result in parallel operation and AC power from the utility / generator will be fed back into the inverter which will instantly damage the output section of the inverter and may also pose a fire and safety hazard. If an electrical breaker panel /

SECTION 8 | Installation

load center is being fed from the utility power / generator and the inverter is required to feed this panel as backup power source, the AC power from the utility power/ generator and the inverter should first be fed to a manual selector switch / Automatic Transfer Switch and the output of the manual selector switch / Automatic Transfer Switch should be connected to the electrical breaker panel / load center.

2. To prevent possibility of paralleling and severe damage to the inverter, never use a simple jumper cable with a male plug on both ends to connect the AC output of the inverter to a handy wall receptacle in the home.

8.5.1 AC Output Receptacle(s)

For AC output connection, the inverter uses European "Schuko" Receptacle Type CEE 7/3 (6 in Fig 6.1). This type of receptacle is used in Germany, Australia, the Netherlands, Sweden, Norway and Finland amongst others. Corresponding "Schuko" Plug, Type CEE 7/4 or CEE 7/7 is required on the power cord feeding the AC loads to be connected to the inverter. The construction of the "Schuko" Receptacle (Type CEE 7/3) and Plug (CEE 7/7) is shown at Figs 8.2.1 and 8.2.2 respectively.

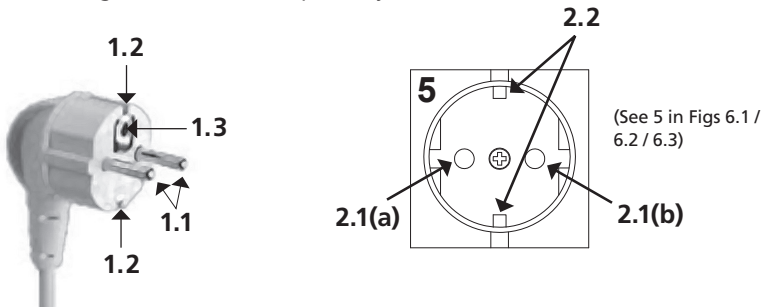

European "Schuko" Plug, Type CEE 7/7

- 1.1: Non-polarized male pins for current carrying conductors
- 1.2: Grounding Contact Strips
- 1.3: Grounding Socket (Not provided in Schuko Plug Type CEE 7/4)

Fig. 8.2.1 Schuko Type Plug CEE 7/7

European "Schuko" Receptacle, Type CEE 7/3

- 2.1(a): Live/Hot socket "L1" - internally connected to L1 (Brown wire)
- 2.1(b): Live/Hot socket "L2" - internally connected to L2 (Blue wire)
- 2.2: Grounding Spring Contact - internally connected to the metal chassis of the inverter / Grounding Terminal (7 in Figs 6.1 / 6.2 / 6.3)

Fig. 8.2.2 Schuko Receptacle CEE 7/3

In the "Schuko" Receptacle, Type CEE 7/3 (Fig 8.2.2), there is NO Neutral and both the sockets L1 and L2 are HOT/LIVE and will be floating and at elevated voltage with respect to the metal chassis Ground / Earth Ground as per Columns (2) and (3) of Table 8.3:

SECTION 8 | Installation

TABLE 8.3: VOLTAGES ON "SCHUKO" OUTLET PINS (See Fig 8.2.2)

Model No. (1)	Voltage between left socket "L1" and metal chassis / Grounding Spring Contact (2)	Voltage between right socket "L2" and metal chassis / Grounding Spring Contact (3)	Voltage between left socket "L1" and right socket "L2" (4)
PST-60S-12E	210 ± 10 VAC	20 ± 10 VAC	230 VAC ± 3%
PST-60S-24E	210 ± 10 VAC	20 ± 10 VAC	230 VAC ± 3%
PST-100S-12E	145 ± 10 VAC	85 ± 10 VAC	230 VAC ± 3%
PST-100S-24E	145 ± 10 VAC	85 ± 10 VAC	230 VAC ± 3%
PST-150S-12E	135 ± 10 VAC	95 ± 10 VAC	230 VAC ± 3%
PST-150S-24E	135 ± 10 VAC	95 ± 10 VAC	230 VAC ± 3%
PST-200S-12E	140 ± 10 VAC	80 ± 10 VAC	230 VAC ± 3%
PST-200S-24E	140 ± 10 VAC	80 ± 10 VAC	230 VAC ± 3%

The 2 grounding spring contacts (2.2, Fig 8.2.2) on the periphery are internally connected to the metal chassis of the inverter / Grounding Terminal (7 in Figs 6.1 / 6.2 / 6.3) which is, in turn, connected to the Earth Ground System of the premises where the inverter is installed. When the "Schuko" Plug, Type CEE 7/7 (Fig 8.2.1) of the Power Cord of the AC load is inserted into the "Schuko" Receptacle, Type CEE 7/3 (Fig 8.2.2) on the inverter, the metal chassis of the AC load is automatically connected to the Earth Ground System of the premises where the inverter is installed.



WARNING!

As explained above, in "Schuko" Receptacle, Type CEE 7/3 (Fig 8.2.2), there is NO Neutral and both the L1 and L2 sockets will be HOT / LIVE and will be at elevated voltage with respect to the metal chassis of the inverter / Earth as per Column (2) of Table 8.3. The mating "Schuko" Plug, Type CEE 7/7 (Fig 8.2.1) is NOT polarized i.e. the plug can be inserted in the receptacle in 2 orientations. Ideally, a Double Pole Switch / Breaker will be required on the load side to safely disconnect both the HOT / LIVE AC input lines from the internal downstream sections of the AC load. If a single pole AC Input ON/ OFF Switch / Breaker is used on the AC load for AC input, it is likely that the Switch / Breaker may get connected in series with the lower voltage current carrying conductor (20 to 95 VAC ± 10% with respect to the metal chassis Ground as per Column (3) of Table 8.3). Hence, even when the ON/OFF Switch / Breaker on the load has been switched OFF, the higher voltage current carrying conductor (135 to 210 VAC ± 10% as per Column (2) of Table 8.3) may still remain connected to the internal downstream sections of the load and will be a shock hazard!

8.5.2 Providing Backup Power Using Transfer Switch

For this application, use a Transfer Switch that has Double Pole, Double Throw Contacts.

- Feed utility power and output power from the inverter to the two inputs of the Transfer Relay.
- Feed the output of the Transfer Switch to a Sub-Panel to feed AC loads requiring backup power.

SECTION 8 | Installation

8.6 GROUNDING TO EARTH OR TO OTHER DESIGNATED GROUND

NOTE: Recommendations given below are based on Protective Multiple Earthing (PME) or TN-C-S Earthing System.

For safety, connect the metal chassis of the inverter to the Main Earthing Terminal of the premises or to the other designated Ground (For example, in a vehicle, the metal frame / chassis of the vehicle is normally designated as the Negative DC Ground). A Chassis Grounding Terminal (7 in Figs 6.1 / 6.2 / 6.3) has been provided for grounding the metal chassis of the inverter to the appropriate Ground.

When using the inverter in a building, connect a 10 mm² or AWG #8 insulated stranded copper wire from the above Chassis Grounding Terminal to the Earth Ground connection (a connection that connects to the Ground Rod or to buried metallic water pipe or to another connection that is solidly bonded to the Earth Ground). The connections must be tight against bare metal. Use star washers to penetrate paint and corrosion.

When using the inverter in RVs / Motor Home / Trailers / Campers / Caravans, connect a 10 mm² or AWG #8 insulated stranded copper wire from the above Chassis Grounding Terminal to the Main Grounding Bus Bar of the vehicle (bonded to the vehicle chassis). The connections must be tight against bare metal. Use star washers to penetrate paint and corrosion.

8.7 OPTIONAL WIRED REMOTE CONTROL – MODEL RC-15

An optional wired Remote Control Model RC-15 is available for switching ON and switching OFF the AC output of the inverter. RC-15 comes with 15ft of cable. The cable is connected to the Remote Control Jack on the inverter (10 in Figs 6.1, 6.2 and 6.3). The Remote has a Red LED that will be lighted when the AC output of the inverter has been switched ON. Please read RC-15 manual for more details.



CAUTION!

For the Remote Control RC-15 to operate, **the inverter has to be FIRST switched ON using the ON/OFF Switch on the inverter** (1 in Figs 6.1, 6.2 and 6.3). **The ON/OFF Switch on the inverter has to be kept in ON condition** during the period the Remote Control RC-15 is being used. The AC output of the inverter will be switched ON / OFF using the ON/OFF Push Button on RC-15.

As the ON/OFF Switch on the inverter is required to be in ON condition during the use of RC-15, the inverter will NOT switch OFF completely when its AC output is switched OFF using RC-15 but some control circuitry in the inverter will still be active. Hence, there will be a minor draw of < 5mA from the battery even when the AC output of the inverter has been switched OFF using RC-15. **However, when the inverter is switched OFF completely by switching OFF the ON/OFF Switch on the inverter, there will be no draw from the battery.**

SECTION 9 | Operation

9.1 SETTING OUTPUT FREQUENCY

Default frequency is 50 Hz. Output frequency may be changed to 60 Hz using 50/60 Hz Selector Switch (11 in Figs 6.1 / 6.2 / 6.3). Frequency should be changed only after switching the inverter to OFF condition first.

9.2 SWITCHING THE INVERTER ON/OFF

Before switching on the inverter, check that all the AC loads have been switched off and the desired output frequency has been selected (See 9.1 above). The ON/OFF Switch (1 in Figs 6.1 / 6.2 / 6.3) on the front panel of the inverter is used to switch ON and switch OFF the inverter. This switch operates a low power control circuitry, which in turn controls all the high power circuitry.

The unit can also be switched ON/OFF remotely with the help of optional Remote Control RC-15 (See Section 8.7):



CAUTION!

Please note that the ON/OFF switch is not switching the high power battery input circuit. Parts of the DC side circuit will still be alive even when the switch is in the OFF position. Hence, disconnect the DC and AC sides before working on any circuits connected to the inverter.

When the inverter is switched ON, the Green LED marked "POWER" (2 in Figs 6.1 / 6.2 / 6.3) will be lighted. This LED indicates that the input section of the inverter is operating normally. Under normal operating conditions, AC output voltage will now be available at the Schuko Receptacle (5 in Figs 6.1 / 6.2 / 6.3).

Switch on the AC load(s). The Green LED marked "POWER" (2 in Figs 6.1 / 6.2 / 6.3) should remain lighted for normal operation of the load.

9.3 POWERING ON THE LOADS

After the inverter is switched ON, it takes a finite time to become ready to deliver full power. Hence, always switch on the load(s) after a few seconds of switching ON the inverter. Avoid switching on the inverter with the load already switched on. This may prematurely trigger the overload protection.

When a load is switched ON, it may require initial higher power surge to start. Hence, if multiple loads are being powered, they should be switched ON one by one so that the inverter is not overloaded by the higher starting surge if all the loads are switched ON at once.

9.4 TEMPERATURE CONTROLLED COOLING FAN

Cooling is carried out by thermostatically controlled fan(s). PST-60S / PST-100S have 1 fan (6 in Figs 6.1 and 6.2). PST-150S / PST-200S have 2 fans (6 in Fig 6.3). Temperature of a critical hot spot inside the inverter is monitored to activate the fan and the over temperature shut-down. When the temperature of this hot spot reaches $55^{\circ}\text{C} \pm 3^{\circ}\text{C}$, the fan is switched

SECTION 9 | Operation

ON. The fan will be automatically switched OFF once the hot spot cools down to $45^{\circ}\text{C} \pm 3^{\circ}\text{C}$. Please note that the fan may not switch ON at low loads or if the ambient temperature is cooler. This is normal.

9.5 INDICATIONS FOR NORMAL OPERATION

When the inverter is operating normally and supplying AC load(s), the Green LED marked "POWER" (2 in Figs 6.1 / 6.2 / 6.3) will be lighted. *Please see Section 10 "Protections" and Section 11 "Troubleshooting Guide" for symptoms of abnormal operation.*

9.6 NO LOAD DRAW (IDLE CURRENT)

When the unit is switched ON, all the circuitry inside the inverter becomes alive and the AC output is made available. In this condition, even when no load is being supplied (or, if a load is connected but has been switched OFF), the inverter draws a small amount of current from the batteries to keep the circuitry alive and ready to deliver the required power on demand. This is called the "Idle Current" or the "No Load Draw". Hence, when the load is not required to be operated, turn OFF the inverter to prevent unnecessary current drain from the battery.



CAUTION!

When the AC output of the inverter is switched OFF using the optional external Remote Control RC-15, there will be a very minor current drain of < 5 mA. There will be **NO** drain from the battery when the inverter is switched OFF by switching OFF the ON/OFF Switch (1 in Figs 6.1 / 6.2 / 6.3). Refer to Section 8.7 for details.

SECTION 10 | Protections

10. PROTECTIONS

The inverter has been provided with protections detailed below:

10.1 POWER SURGE / OVERLOAD / SHORT CIRCUIT SHUT DOWN



INFO

Please refer to definitions of Active Power (Watts), Apparent Power (VA) and Power Factor (PF) at Section 2.1. In the explanation below, the values of Power are expressed in Apparent Power in VA. Corresponding Active Power (Watts, W) will depend upon the type of load (Resistive or Reactive) and its Power Factor (Power Factor may range from 1 to 0.5). Please note the following:

- Active Power (Watts) = Apparent Power (VA) x Power Factor (PF).
- For resistive type of loads, the Power Factor = 1 and hence, Apparent Power (VA) = Active Power (Watts, W)
- For reactive types of loads, the Power Factor will be < 1 (up to 0.5) and hence, the Active Power (Watts, W) will be less than the Apparent Power (VA)

The AC output voltage will shut down due to overload and short circuit conditions as follows:

Power Surge Condition: When the AC output current tries to exceed around 160% of the rated value for PST-600 or 200% of the rated value for PST-100S / 150S / 200S, output current limiting is carried out instantly resulting in drop in the AC output voltage (the drop is proportional to the load impedance). Surge Power of 160% / 200% will, thus, be provided for < 8 ms every half cycle. If this situation continues for 2 to 2.5 sec Overload Condition is activated.

Overload Condition for PST-60S/100S: If there is a continuous overload of 110% to 120% for 3 to 5 sec, the AC output voltage will be shut down. Red LED marked "OVERLOAD" (3 in Figs 6.1/6.2/6.3) will turn ON and buzzer alarm will sound. The Green LED marked "POWER" (2 in Figs 6.1/6.2/6.2) will continue to be lighted. The unit will be latched in this shut down condition and will require manual reset. To reset, switch the unit OFF, wait for 3 minutes and then switch ON the unit again. Before switching ON, determines and remove the cause of overload

Overload Condition for PST-150S/200S: If there is a continuous overload of 110% to 120% for 2 to 4 sec, the AC output voltage will be shut down. Red LED marked "OVERLOAD" (3 in Figs 6.1/6.2/6.3) will turn ON and buzzer alarm will sound. The Green LED marked "POWER" (2 in Figs 6.1/6.2/6.2) will continue to be lighted. The unit will be latched in this shut down condition and will require manual reset. To reset, switch the unit OFF, wait for 3 minutes and then switch ON the unit again. Before switching ON, determines and remove the cause of overload

Short Circuit Condition: Short circuit condition will be detected when the AC output voltage drops to < 170 VAC or lower over a period of around 1 to 1.5 sec. The AC output voltage will be shut down thereafter.

SECTION 10 | Protections

Red LED marked "OVERLOAD" (3 in Figs 6.1 / 6.2 / 6.3) will turn ON and buzzer alarm will sound. The Green LED marked "POWER" (2 in Figs 6.1 / 6.2 / 6.3) will continue to be lighted. The unit will be latched in this shut down condition and will require manual reset. To reset, switch OFF the unit, wait for 3 minutes and then switch ON the unit again. Before switching ON, determine and remove the cause of overloading.

10.2 WARNING ALARM - LOW DC INPUT VOLTAGE

The voltage at the DC input terminals will be lower than the voltage at the battery terminals due to voltage drop in the battery wires and connectors. The drop in the voltage at the DC input terminals of the inverter could be due to lower battery voltage or due to abnormally high drop in the battery wires if the wires are not thick enough (*Please see Section 8.4.3 "Connection from Batteries to the DC Input Side-Sizing of Cables and Fuses"*). If the voltage at the DC input terminals drops to $10.7V \pm 0.1V$ or lower for the 12V versions or, to $21.4V \pm 0.2V$ or lower for the 24V versions, a buzzer alarm will be sounded. The Green LED marked "POWER" (2 in Figs 6.1 / 6.2 / 6.3) will continue to be lighted and the AC output voltage would continue to be available. This warning buzzer alarm indicates that the battery is running low and that the inverter will be shut down after sometime if the voltage at the inverter terminals further drops to $10V \pm 0.1V$ or lower for the 12V versions or $20V \pm 0.2V$ or lower for the 24V versions.

10.3 LOW DC INPUT VOLTAGE SHUT DOWN

If the voltage at the DC input terminals drops to $10V \pm 0.1V$ or lower for the 12V versions or $20V \pm 0.2V$ or lower for the 24V versions, the AC output is shut down. Buzzer alarm is sounded. The Green LED marked "POWER" (2 in Figs 6.1 / 6.2 / 6.3) will remain lighted.

The unit will reset automatically when the DC input voltage rises to $11.5V \pm 0.3V$ or higher for the 12V versions or to $23V \pm 0.5V$ or higher for the 24V versions.

10.4 HIGH DC INPUT VOLTAGE SHUTDOWN

If the voltage at the DC input terminals rises to 16.5V or higher for the 12V versions or, to 33V or higher for the 24V versions, the AC output voltage will be shut down temporarily. Buzzer alarm will be sounded. The Green LED marked "POWER" (2 in Figs 6.1 / 6.2 / 6.3) will remain lighted. The unit will be reset automatically when the voltage drops down to $< 16.5V$ for the 12V versions or to $< 33V$ for the 24V versions.

10.5 OVER-TEMPERATURE SHUT DOWN

In case of failure of the cooling fan or in the case of inadequate heat removal due to higher ambient temperatures / insufficient air exchange, the temperature inside the unit will increase. The temperature of a critical hot spot inside the inverter is monitored, and at $90^{\circ}C \pm 5^{\circ}C$, the AC output of the inverter is shut down temporarily. Buzzer alarm will be sounded. The Green LED marked "POWER" (2 in Figs 6.1 / 6.2 / 6.3) will remain lighted.

The unit will automatically reset after the hot spot has cooled down to $65^{\circ}C \pm 5^{\circ}C$.

SECTION 10 | Protections

10.6 INTERNAL DC SIDE FUSES

Table 10.1 below gives details of DC side fuses that have been provided for internal protection of the DC input side. The fuses are 32V, Automotive Type Blade Fuses, Type "ATO" by Littell Fuse or equivalent. **The fuses are soldered to the PCB.**

Model No.	Fuse Capacity		
	Ampere rating of individual fuse	No. of fuses in parallel	Total Amperage of paralleled fuses
PST-60S-12E	40A	2	80A
PST-60S-24E	20A	2	40A
PST-100S-12E	40A	4	160A
PST-100S-24E	20A	4	80A
PST-150S-12E	40A	5	200A
PST-150S-24E	20A	5	100A
PST-200S-12E	40A	6	240A
PST-200S-24E	20A	6	120A

NOTE: Each fuse is 32V, Automotive Blade Fuse Type "ATO" by Little Fuse or equivalent

10.7 REVERSE POLARITY AT THE DC INPUT TERMINALS

The Positive of the battery should be connected to the Positive DC input terminal of the inverter and the Negative of the battery should be connected to the Negative DC input terminal of the inverter. A reversal of polarity (the Positive of the battery wrongly connected to the Negative DC input terminal of the inverter and the Negative of the battery wrongly connected to the Positive DC input terminal of the inverter) will blow the external / internal DC side fuses. If the DC side fuse is blown, the inverter will be dead. The Green LED marked "POWER" (2, Fig 6.1a) will be switched OFF and there will be no AC output.



INFO

Reverse polarity connection is likely to damage the DC input circuitry. The internal fuse(s) should be replaced with the same size of fuse(s) used in the unit. If the unit does not work after replacing the fuse(s), it has been permanently damaged and will require repair / replacement (*Please read Section 11 - "Troubleshooting Guide" for more details*).



CAUTION!

Damage caused by reverse polarity is not covered by warranty! When making battery connections on the input side, make sure that the polarity of battery connections is correct (Connect the Positive of the battery to the Positive terminal of the unit and the Negative of the battery to the Negative terminal of the unit). If the input is connected in reverse polarity, DC fuse(s) inside the inverter / external fuse will blow and may also cause permanent damage to the inverter.

SECTION 11 | Troubleshooting Guide

ISSUE	POSSIBLE CAUSE	REMEDY
<p>When switched ON, the Green LED marked "POWER" does not light. Buzzer is OFF. There is no AC output voltage.</p>	<p>There is no voltage at the DC input terminals</p>	<ul style="list-style-type: none"> • Check the continuity of the battery input circuit. • Check that the internal/external battery fuses are intact. Replace if blown. • Check that all connections in the battery input circuit are tight.
	<p>Polarity of the DC input voltage has been reversed that has blown the external / internal DC side fuses (Note: Reverse polarity may cause permanent damage. Damage caused due to reverse polarity is not covered by warranty)</p>	<ul style="list-style-type: none"> • Check external and internal fuses. Internal fuses may be soldered and may not be easily replaceable. Replace fuses. If unit does not work, call Technical Support for repair.
<p>Low AC output voltage (No buzzer alarm).</p>	<ul style="list-style-type: none"> • AC load is exceeding 200% Surge Overload • Load is approaching 200% Surge Overload during lower DC input voltage 	<ul style="list-style-type: none"> • Check that the battery is fully charged. Recharge, if low. • Check that the battery cables are thick enough to carry the required current over the required length. Use thicker cables, if required. • Tighten connections of battery input circuit. • Reduce load.
<p>AC output voltage is available. Buzzer alarm is sounded at no load or when load is switched ON. The Green LED marked "POWER" is lighted.</p>	<ul style="list-style-type: none"> • Low DC input voltage alarm • DC input voltage is 10.7V or lower but > 10V \pm 0.1V for the 12V versions • DC input voltage is 21.4V \pm 0.2V or lower but > 20V \pm 0.2V for the 24V versions 	<ul style="list-style-type: none"> • Check that the battery is fully charged. Recharge, if low. • Check that the battery cables are thick enough to carry the required current over the required length. Use thicker cables, if required. • Tighten connections of the battery input circuit.
<p>There is no AC output voltage. Buzzer alarm is sounded at no load or when load is switched ON. The Green LED marked "POWER" is lighted.</p>	<ul style="list-style-type: none"> • AC output voltage has been shut down due to low DC input voltage • DC input voltage is 10V \pm 0.1V or lower for the 12V versions • DC input voltage is 20V \pm 0.2V or lower for the 24V versions 	<ul style="list-style-type: none"> • Check that the battery is fully charged. Recharge, if low. • Check that the battery cables are thick enough to carry the required current over the required length. Use thicker cables, if required. • Tighten connections of the battery input circuit. • The AC output voltage will switch ON automatically when the DC input voltage rises to 11.5V \pm 0.1V or higher for the 12V versions or 23V \pm 0.2V or higher for the 24V versions.

SECTION 11 | Troubleshooting Guide

ISSUE	POSSIBLE CAUSE	REMEDY
<p>There is no AC output. The Green LED marked "POWER" is lighted. Buzzer is ON.</p>	<p>Shut-down due to high input DC voltage – 16.5V or higher for the 12V versions and 33V or higher for the 24V versions.</p>	<ul style="list-style-type: none"> • Check that the voltage at the DC input terminals is less than 16.5V for the 12V versions and less than 33V for the 24V versions. • Ensure that the maximum charging voltage of the battery charger / alternator / solar charge controller is below 16.5V for the 12V versions and below 33V for the 24V versions. • Ensure that an unregulated solar panel is not used to charge a battery. Under cold ambient temperatures, the output of the solar panels may exceed 22V for 12V Panels or 42V for 24V Panels. Ensure that a charge controller is used between the solar panel and the battery. • Automatic Reset when voltage drops to < 16.5V for the 12V versions or < 33V for 24V versions.
<p>AC output shuts down completely. Red LED marked "OVERLOAD" is lighted. Buzzer is ON. The Green LED marked "POWER" (2, Fig 6.1a) is lighted.</p>	<p>Permanent shut-down of the AC output due to:</p> <ul style="list-style-type: none"> (i) Continuous overload of 110% to 120% for 3 to 5 sec for PST-60S / PST-100S or 2 to 4 sec for PST-150S / PST-200S (ii) Short circuit resulting in output voltage dropping to 170 VAC or below for 1 to 1.5 sec. 	<ul style="list-style-type: none"> • Reduce the load / remove the short circuit • The load is not suitable as it requires higher power to operate. Use an inverter with higher power rating. • If the unit goes into permanent overload again after resetting and removing the load completely, the unit has become defective. Call Technical support. <p>NOTE: The unit will be latched in this shut-down condition and will require manual reset. To reset, switch OFF the power ON/OFF switch, wait for 3 minutes and then switch ON again. Before switching on again, remove the cause of the shut-down.</p>
<p>There is no AC output. Buzzer alarm is sounded. Red LED marked "OVER TEMP" is lighted. The Green LED marked "POWER" is lighted.</p>	<p>Shut-down due to over temperature because of fan failure or inadequate cooling as a result of high ambient temperature or insufficient air exchange</p>	<p>Check that the fans are working. If not, the fan control circuit may be defective. Call Technical Support.</p> <p>If the fans are working, check that the ventilation slots on the suction side and the openings on the discharge side of the fans are not obstructed.</p> <p>If the fans are working and the openings are not obstructed, check that enough cool replacement air is available. Also check that the ambient air temperature is less than 40°C.</p> <p>Reduce the load to reduce the heating effect.</p> <p>After the cause of overheating is removed and the unit cools down sufficiently, it will reset automatically.</p>

SECTION 12 | Specifications

MODEL NO.	PST-60S-12E	PST-60S-24E
OUTPUT		
OUTPUT VOLTAGE	230 VAC ± 3%	230 VAC ± 3%
MAXIMUM OUTPUT CURRENT	2.61A	2.61A
OUTPUT FREQUENCY	50/60 Hz ± 1% : Switch Selectable (Default 50 Hz)	
TYPE OF OUTPUT WAVEFORM	Pure Sine Wave	Pure Sine Wave
TOTAL HARMONIC DISTORTION OF OUTPUT WAVEFORM	< 3%	< 3%
CONTINUOUS OUTPUT POWER (At Power Factor = 1)	600 Watts	600 Watts
SURGE OUTPUT POWER	1000 Watts (< 8 ms)	1000 Watts (< 8 ms)
PEAK EFFICIENCY	> 85% (At full load)	> 85% (At full load)
AC OUTPUT CONNECTIONS	European "Schuko", CEE 7/3 AC Receptacle	
INPUT		
NOMINAL DC INPUT VOLTAGE	12V	24V
DC INPUT VOLTAGE RANGE	10.7 - 16.5 VDC	21.4 - 33 VDC
MAXIMUM INPUT CURRENT	80A	40A
DC INPUT CURRENT AT NO LOAD	< 0.8A	< 0.6A
DC INPUT CONNECTIONS	Terminals with cylindrical hole: Diameter 11 mm ; M8 set screw	
DC INPUT FUSES (INTERNAL)	2 X 40A = 80A (Each Type ATC, 32V, 40A)	2 x 20A = 40A (Each Type ATC, 32V, 20A)
DISPLAY		
LED	Power, Overload, Over Temperature	Power, Overload, Over Temperature
PROTECTIONS		
LOW DC INPUT VOLTAGE ALARM	10.7V ± 0.1V	21.4V ± 0.2V
LOW DC INPUT VOLTAGE SHUTDOWN	10V ± 0.1V ; Auto-reset: 11.5V ± 0.3V	20V ± 0.2V ; Auto-reset: 23V ± 0.5V
HIGH DC INPUT VOLTAGE SHUTDOWN	16.5V ; Auto-reset: < 16.5V	33V ; Auto-reset: < 33V
SHORT CIRCUIT SHUTDOWN	When output voltage drops to 170VAC or lower for 1 to 1.5 sec	
OVERLOAD SHUTDOWN	At overload of 110% to 120% for 3 to 5 sec	
OVER TEMPERATURE SHUTDOWN	90°C ± 5°C ; Auto reset at 65°C ± 5°C (sensed at internal hot spot)	
REVERSE POLARITY ON DC INPUT SIDE	External / internal DC sides fuses will blow	
REMOTE CONTROL		
WIRED REMOTE CONTROL WITH LED / LED DISPLAY	RC-15 (sold separately) with 15' cable	
COOLING		
FORCED AIR COOLING	Temperature controlled fan. Fan ON at 55°C ± 3°C; Fan OFF at 45°C ± 3°C (sensed at internal hot spot)	
COMPLIANCE		
EUROPEAN CONFORMITY	CE marked	
SAFETY	European Low Voltage Directive 2014/35/EU • Standard : EN 60950-1	
EMC	European EMC Directive 2014/30/EU per following Standards: • EMI: EN55022, Class B ; EN61000-3-2, -3-3 • EMS: EN55024; EN61000-4-2, -4-3, -4-4, -4-5, -4-6, -4-8, -4-11	
RoHS2	European Directive 2011/65/EU	
ENVIRONMENT		
WORKING ENVIRONMENT	Indoor use	
OPERATING TEMPERATURE RANGE	0°C to 40°C / 32°F to 104°F	0°C to 40°C / 32°F to 104°F
RELATIVE HUMIDITY	Up to 85%, non condensing	
DIMENSIONS		
(W X D X H), MM	240.6 x 281.0 x 82.0	240.6 x 281.0 x 82.0
(W X D X H), INCHES	9.5 x 11.1 x 3.2	9.5 x 11.1 x 3.2
WEIGHT		
KG	2.5	2.5
LBS	5.4	5.4

NOTES:

1. All power ratings are specified for resistive load at Power Factor = 1.
2. All specifications given above are at ambient temperature of 25°C / 77°F.
3. Specifications are subject to change without notice

SECTION 12 | Specifications

MODEL NO.	PST-100S-12E	PST-100S-24E
OUTPUT		
OUTPUT VOLTAGE	230 VAC ± 3%	230 VAC ± 3%
MAXIMUM OUTPUT CURRENT	4.35A	4.35A
OUTPUT FREQUENCY	50/60 Hz ± 1% : Switch Selectable (Default 50 Hz)	
TYPE OF OUTPUT WAVEFORM	Pure Sine Wave	Pure Sine Wave
TOTAL HARMONIC DISTORTION OF OUTPUT WAVEFORM	< 3%	< 3%
CONTINUOUS OUTPUT POWER (At Power Factor = 1)	1000 Watts	1000 Watts
SURGE OUTPUT POWER	2000 Watts (< 8 ms)	2000 Watts (< 8 ms)
PEAK EFFICIENCY	> 85% (At full load)	> 85% (At full load)
AC OUTPUT CONNECTIONS	European "Schuko", CEE 7/3 AC Receptacle	
INPUT		
NOMINAL DC INPUT VOLTAGE	12V	24V
DC INPUT VOLTAGE RANGE	10.7 - 16.5 VDC	21.4 - 33 VDC
MAXIMUM INPUT CURRENT	160A	80A
DC INPUT CURRENT AT NO LOAD	< 0.8A	< 0.6A
DC INPUT CONNECTIONS	Terminals with cylindrical hole: Diameter 11 mm ; M8 set screw	
DC INPUT FUSES (INTERNAL)	4 X 40A = 160A (Each Type ATC, 32V)	4 x 20A = 80A (Each Type ATC, 32V)
DISPLAY		
LED	Power, Overload, Over Temperature	Power, Overload, Over Temperature
PROTECTIONS		
LOW DC INPUT VOLTAGE ALARM	10.7V ± 0.1V	21.4V ± 0.2V
LOW DC INPUT VOLTAGE SHUTDOWN	10V ± 0.1V ; Auto-reset: 11.5V ± 0.3V	20V ± 0.2V ; Auto-reset: 23V ± 0.5V
HIGH DC INPUT VOLTAGE SHUTDOWN	16.5V ; Auto-reset: < 16.5V	33V ; Auto-reset: < 33V
SHORT CIRCUIT SHUTDOWN	When output voltage drops to 170VAC or lower for 1 to 1.5 sec	
OVERLOAD SHUTDOWN	At overload of 110% to 120% for 3 to 5 sec	
OVER TEMPERATURE SHUTDOWN	90°C ± 5°C ; Auto reset at 65°C ± 5°C (sensed at internal hot spot)	
REVERSE POLARITY ON DC INPUT SIDE	External / internal DC sides fuses will blow	
REMOTE CONTROL		
WIRED REMOTE CONTROL WITH LED / LED DISPLAY	RC-15 (sold separately) with 15' cable	
COOLING		
FORCED AIR COOLING	Temperature controlled fan. Fan ON at 55°C ± 3°C; Fan OFF at 45°C ± 3°C (sensed at internal hot spot)	
COMPLIANCE		
EUROPEAN CONFORMITY	CE marked	
SAFETY	European Low Voltage Directive 2014/35/EU • Standard : EN 60950-1	
EMC	European EMC Directive 2014/30/EU per following Standards: • EMI: EN55022, Class B ; EN61000-3-2, -3-3 • EMS: EN55024; EN61000-4-2, -4-3, -4-4, -4-5, -4-6, -4-8, -4-11	
RoHS2	European Directive 2011/65/EU	
ENVIRONMENT		
WORKING ENVIRONMENT	Indoor use	
OPERATING TEMPERATURE RANGE	0°C to 40°C / 32°F to 104°F	0°C to 40°C / 32°F to 104°F
RELATIVE HUMIDITY	Up to 85%, non condensing	
DIMENSIONS		
(W X D X H), MM	240.6 x 400.0 x 82.0	240.6 x 400.0 x 82.0
(W X D X H), INCHES	9.5 x 15.7 x 3.2	9.5 x 15.7 x 3.2
WEIGHT		
KG	4.0	4.0
LBS	8.8	8.8

NOTES:

1. All power ratings are specified for resistive load at Power Factor = 1.
2. All specifications given above are at ambient temperature of 25°C / 77°F.
3. Specifications are subject to change without notice

SECTION 12 | Specifications

MODEL NO.	PST-150S-12E	PST-150S-24E
OUTPUT		
OUTPUT VOLTAGE	230 VAC \pm 3%	230 VAC \pm 3%
MAXIMUM OUTPUT CURRENT	6.52A	6.52A
OUTPUT FREQUENCY	50/60 Hz \pm 1% : Switch Selectable (Default 50 Hz)	
TYPE OF OUTPUT WAVEFORM	Pure Sine Wave	Pure Sine Wave
TOTAL HARMONIC DISTORTION OF OUTPUT WAVEFORM	< 3%	< 3%
CONTINUOUS OUTPUT POWER (At Power Factor = 1)	1500 Watts	1500 Watts
SURGE OUTPUT POWER	3000 Watts (< 8 ms)	3000 Watts (< 8 ms)
PEAK EFFICIENCY	> 85% (At full load)	> 85% ((At full load)
AC OUTPUT CONNECTIONS	Two European "Schuko", CEE 7/3 AC Receptacles	
INPUT		
NOMINAL DC INPUT VOLTAGE	12V	24V
DC INPUT VOLTAGE RANGE	10.7 - 16.5 VDC	21.4 - 33 VDC
MAXIMUM INPUT CURRENT	200A	100A
DC INPUT CURRENT AT NO LOAD	< 0.8A	< 0.6A
DC INPUT CONNECTIONS	Terminals with cylindrical hole: Diameter 11 mm ; M8 set screw	
DC INPUT FUSES (INTERNAL)	5 X 40A = 200A (Each Type ATC, 32V)	5 x 20A = 100A (Each Type ATC, 32V)
DISPLAY		
LED	Power, Overload, Over Temperature	Power, Overload, Over Temperature
PROTECTIONS		
LOW DC INPUT VOLTAGE ALARM	10.7V \pm 0.1V	21.4V \pm 0.2V
LOW DC INPUT VOLTAGE SHUTDOWN	10V \pm 0.1V ; Auto-reset: 11.5V \pm 0.3V	20V \pm 0.2V ; Auto-reset: 23V \pm 0.5V
HIGH DC INPUT VOLTAGE SHUTDOWN	16.5V ; Auto-reset: < 16.5V	33V ; Auto-reset: < 33V
SHORT CIRCUIT SHUTDOWN	When output voltage drops to 170VAC or lower for 1 to 1.5 sec	
OVERLOAD SHUTDOWN	At overload of 110% to 120% for 2 to 4 sec	
OVER TEMPERATURE SHUTDOWN	90°C \pm 5°C ; Auto reset at 65°C \pm 5°C (sensed at internal hot spot)	
REVERSE POLARITY ON DC INPUT SIDE	External / internal DC sides fuses will blow	
REMOTE CONTROL		
WIRED REMOTE CONTROL WITH LED / LED DISPLAY	RC-15 (sold separately) with 15' cable	
COOLING		
FORCED AIR COOLING	Temperature controlled fan. Fan ON at 55°C \pm 3°C; Fan OFF at 45°C \pm 3°C (sensed at internal hot spot)	
COMPLIANCE		
EUROPEAN CONFORMITY	CE marked	
SAFETY	European Low Voltage Directive 2014/35/EU • Standard : EN 60950-1	
EMC	European EMC Directive 2014/30/EU per following Standards: • EMI: EN55022, Class B ; EN61000-3-2, -3-3 • EMS: EN55024; EN61000-4-2, -4-3, -4-4, -4-5, -4-6, -4-8, -4-11	
RoHS2	European Directive 2011/65/EU	
ENVIRONMENT		
WORKING ENVIRONMENT	Indoor use	
OPERATING TEMPERATURE RANGE	0°C to 40°C / 32°F to 104°F	0°C to 40°C / 32°F to 104°F
RELATIVE HUMIDITY	Up to 85%, non condensing	
DIMENSIONS		
(W X D X H), MM	282 x 415 x 101	282 x 415 x 101
(W X D X H), INCHES	11.1 x 16.3 x 4.0	11.1 x 16.3 x 4.0
WEIGHT		
KG	5.7	5.7
LBS	12.7	12.7

NOTES:

1. All power ratings are specified for resistive load at Power Factor = 1.
2. All specifications given above are at ambient temperature of 25°C / 77°F.
3. Specifications are subject to change without notice

SECTION 12 | Specifications

MODEL NO.	PST-200S-12E	PST-200S-24E
OUTPUT		
OUTPUT VOLTAGE	230 VAC \pm 3%	230 VAC \pm 3%
MAXIMUM OUTPUT CURRENT	8.7A	8.7A
OUTPUT FREQUENCY	50/60 Hz \pm 1% : Switch Selectable (Default 50 Hz)	
TYPE OF OUTPUT WAVEFORM	Pure Sine Wave	Pure Sine Wave
TOTAL HARMONIC DISTORTION OF OUTPUT WAVEFORM	< 3%	< 3%
CONTINUOUS OUTPUT POWER (At Power Factor = 1)	2000 Watts	2000 Watts
SURGE OUTPUT POWER	4000 Watts (< 8 ms)	4000 Watts (< 8 ms)
PEAK EFFICIENCY	> 85% (At full load)	> 85% ((At full load)
AC OUTPUT CONNECTIONS	Two European "Schuko", CEE 7/3 AC Receptacles	
INPUT		
NOMINAL DC INPUT VOLTAGE	12V	24V
DC INPUT VOLTAGE RANGE	10.7 - 16.5 VDC	21.4 - 33 VDC
MAXIMUM INPUT CURRENT	240A	120A
DC INPUT CURRENT AT NO LOAD	< 0.8A	< 0.6A
DC INPUT CONNECTIONS	Terminals with cylindrical hole: Diameter 11 mm ; M8 set screw	
DC INPUT FUSES (INTERNAL)	6 X 40A = 240A (Each Type ATC, 32V)	6 x 20A = 120A (Each Type ATC, 32V)
DISPLAY		
LED	Power, Overload, Over Temperature	Power, Overload, Over Temperature
PROTECTIONS		
LOW DC INPUT VOLTAGE ALARM	10.7V \pm 0.1V	21.4V \pm 0.2V
LOW DC INPUT VOLTAGE SHUTDOWN	10V \pm 0.1V ; Auto-reset: 11.5V \pm 0.3V	20V \pm 0.2V ; Auto-reset: 23V \pm 0.5V
HIGH DC INPUT VOLTAGE SHUTDOWN	16.5V ; Auto-reset: < 16.5V	33V ; Auto-reset: < 33V
SHORT CIRCUIT SHUTDOWN	When output voltage drops to 170VAC or lower for 1 to 1.5 sec	
OVERLOAD SHUTDOWN	At overload of 110% to 120% for 2 to 4 sec	
OVER TEMPERATURE SHUTDOWN	90°C \pm 5°C ; Auto reset at 65°C \pm 5°C (sensed at internal hot spot)	
REVERSE POLARITY ON DC INPUT SIDE	External / internal DC sides fuses will blow	
REMOTE CONTROL		
WIRED REMOTE CONTROL WITH LED / LED DISPLAY	RC-15 (sold separately) with 15' cable	
COOLING		
FORCED AIR COOLING	Temperature controlled fan. Fan ON at 55°C \pm 3°C; Fan OFF at 45°C \pm 3°C (sensed at internal hot spot)	
COMPLIANCE		
EUROPEAN CONFORMITY	CE marked	
SAFETY	European Low Voltage Directive 2014/35/EU • Standard : EN 60950-1	
EMC	European EMC Directive 2014/30/EU per following Standards: • EMI: EN55022, Class B ; EN61000-3-2, -3-3 • EMS: EN55024; EN61000-4-2, -4-3, -4-4, -4-5, -4-6, -4-8, -4-11	
RoHS2	European Directive 2011/65/EU	
ENVIRONMENT		
WORKING ENVIRONMENT	Indoor use	
OPERATING TEMPERATURE RANGE	0°C to 40°C / 32°F to 104°F	0°C to 40°C / 32°F to 104°F
RELATIVE HUMIDITY	Up to 85%, non condensing	
DIMENSIONS		
(W X D X H), MM	282 x 415 x 101	282 x 415 x 101
(W X D X H), INCHES	11.1 x 16.3 x 4.0	11.1 x 16.3 x 4.0
WEIGHT		
KG	5.9	5.9
LBS	13.0	13.0

NOTES:

1. All power ratings are specified for resistive load at Power Factor = 1.
2. All specifications given above are at ambient temperature of 25°C / 77°F.
3. Specifications are subject to change without notice

SECTION 13 | Warranty

2 YEAR LIMITED WARRANTY

PST-60S-12E / PST-60S-24E / PST-100S-12E / PST-100S-24E / PST-150S-12E / PST-150S-24E / PST-200S-12E / PST-200S-24E manufactured by Samlex America, Inc. (the "Warrantor") are warranted to be free from defects in workmanship and materials under normal use and service. The warranty period is 2 years for the United States and Canada, and is in effect from the date of purchase by the user (the "Purchaser").

Warranty outside of the United States and Canada is limited to 6 months. For a warranty claim, the Purchaser should contact the place of purchase to obtain a Return Authorization Number.

The defective part or unit should be returned at the Purchaser's expense to the authorized location. A written statement describing the nature of the defect, the date of purchase, the place of purchase, and the Purchaser's name, address and telephone number should also be included.

If upon the Warrantor's examination, the defect proves to be the result of defective material or workmanship, the equipment will be repaired or replaced at the Warrantor's option without charge, and returned to the Purchaser at the Warrantor's expense. (Contiguous US and Canada only)

No refund of the purchase price will be granted to the Purchaser, unless the Warrantor is unable to remedy the defect after having a reasonable number of opportunities to do so. Warranty service shall be performed only by the Warrantor. Any attempt to remedy the defect by anyone other than the Warrantor shall render this warranty void. There shall be no warranty for defects or damages caused by faulty installation or hook-up, abuse or misuse of the equipment including exposure to excessive heat, salt or fresh water spray, or water immersion.

No other express warranty is hereby given and there are no warranties which extend beyond those described herein. This warranty is expressly in lieu of any other expressed or implied warranties, including any implied warranty of merchantability, fitness for the ordinary purposes for which such goods are used, or fitness for a particular purpose, or any other obligations on the part of the Warrantor or its employees and representatives.

There shall be no responsibility or liability whatsoever on the part of the Warrantor or its employees and representatives for injury to any persons, or damage to person or persons, or damage to property, or loss of income or profit, or any other consequential or resulting damage which may be claimed to have been incurred through the use or sale of the equipment, including any possible failure of malfunction of the equipment, or part thereof. The Warrantor assumes no liability for incidental or consequential damages of any kind.

Samlex America Inc. (the "Warrantor")
www.samlexamerica.com

Contact Information

Toll Free Numbers

Ph: 1 800 561 5885

Fax: 1 888 814 5210

Local Numbers

Ph: 604 525 3836

Fax: 604 525 5221

Website

www.samlexamerica.com

USA Shipping Warehouses

Kent, WA

Plymouth, MI

Canadian Shipping Warehouse

Delta, BC

Email purchase orders to

orders@samlexamerica.com



samlexamerica®