



samlexpower®

**DC-AC Power
Inverter**
Pure Sine Wave

PSR-1200-24
PSR-1200-48

Owner's
Manual

Please read this
manual BEFORE
installing your
inverter

OWNER'S MANUAL | Index

SECTION 1	Safety Instructions	3
SECTION 2	General Information	6
SECTION 3	Limiting Electromagnetic Interference (EMI)	12
SECTION 4	Powering Direct / Embedded Switch Mode Power Supplies (SMPS)	13
SECTION 5	Description & Principles of Operation	14
SECTION 6	Layout	27
SECTION 7	General Information on Lead Acid Batteries	28
SECTION 8	Installation	37
SECTION 9	Operation	46
SECTION 10	Programming of Operational Parameters	53
SECTION 11	Protections & Alarms	65
SECTION 12	Remote Parameter Monitoring & Setup Using USB / RS-232 Serial Communication Protocol	72
SECTION 13	Web Monitoring & SNMP	78
SECTION 14	Firmware Upgrade / Backup	90
SECTION 15	Specifications	95
SECTION 16	Warranty	97

Disclaimer of Liability

UNLESS SPECIFICALLY AGREED TO IN WRITING, SAMLEX AMERICA INC.:

1. MAKES NO WARRANTY AS TO THE ACCURACY, SUFFICIENCY OR SUITABILITY OF ANY TECHNICAL OR OTHER INFORMATION PROVIDED IN ITS MANUALS OR OTHER DOCUMENTATION.
2. ASSUMES NO RESPONSIBILITY OR LIABILITY FOR LOSSES, DAMAGES, COSTS OR EXPENSES, WHETHER SPECIAL, DIRECT, INDIRECT, CONSEQUENTIAL OR INCIDENTAL, WHICH MIGHT ARISE OUT OF THE USE OF SUCH INFORMATION. THE USE OF ANY SUCH INFORMATION WILL BE ENTIRELY AT THE USERS RISK.

Samlex America reserves the right to revise this document and to periodically make changes to the content hereof without obligation or organization of such revisions or changes.

Copyright Notice/Notice of Copyright

Copyright © 2018 by Samlex America Inc. All rights reserved. Permission to copy, distribute and/or modify this document is prohibited without express written permission by Samlex America Inc.

SECTION 1 | General Safety

1.1 IMPORTANT SAFETY INSTRUCTIONS AND SYMBOLS

SAVE THESE INSTRUCTIONS. This manual contains important instructions for models PSR-1200-24 and PSR-1200-48 that shall be followed during installation, operation and maintenance.

The following safety symbols are used on the unit:



Caution, risk of electric shock.



Disconnection, all power plugs.

The following safety symbols are used in this manual to highlight safety and information:



WARNING!

Indicates possibility of physical harm to the user in case of non-compliance.



CAUTION!

Indicates possibility of damage to the equipment in case of non-compliance.



INFO

Indicates useful supplemental information.

Please read these instructions before installing or operating the unit to prevent personal injury or damage to the unit.

1.2 SAFETY INSTRUCTIONS - GENERAL



WARNING!

Installation and wiring compliance

- Installation and wiring must comply with the Local and National Electrical Codes and must be done by a certified electrician.



WARNING!

Preventing electrical shock

- Always connect the grounding connection on the unit to the appropriate grounding system.
- Disassembly / repair should be carried out by qualified personnel only.
- Disconnect all AC and DC side connections before working on any circuits associated with the unit. Turning the ON/OFF switch on the unit to OFF position may not entirely remove dangerous voltages.

SECTION 1 | Safety Instructions

- Be careful when touching bare terminals of capacitors. Capacitors may retain high lethal voltages even after the power has been removed. Discharge the capacitors before working on the circuits.
- If AC Grid input is available, it will be bypassed to the AC outlets on the unit even if the ON / OFF Switch is in OFF condition (LED marked "AC GRID" will be Green BUT LED marked BYPASS will be OFF). Care should be taken because the AC Outlets will be LIVE in this condition.



CAUTION!

Installation environment

- The inverter should be installed indoor only in a well ventilated, cool, dry environment.
- Do not expose to moisture, rain, snow or liquids of any type.
- To reduce the risk of overheating and fire, do not obstruct the suction and discharge openings of the cooling fans.
- To ensure proper ventilation, do not install in a low clearance compartment.



WARNING!

Preventing fire and explosion hazards.

- Working with the unit may produce arcs or sparks. Thus, the unit should not be used in areas where there are flammable materials or gases requiring ignition protected equipment. These areas may include spaces containing gasoline-powered machinery, fuel tanks, and battery compartments.



WARNING!

Precautions when working with batteries

- Batteries contain very corrosive diluted Sulphuric Acid as electrolyte. Precautions should be taken to prevent contact with skin, eyes or clothing.
- Batteries generate Hydrogen and Oxygen during charging resulting in evolution of explosive gas mixture. Care should be taken to ventilate the battery area and follow the battery manufacturer's recommendations.
- Never smoke or allow a spark or flame near the batteries.
- Use caution to reduce the risk of dropping a metal tool on the battery. It could spark or short circuit the battery or other electrical parts and could cause an explosion.
- Remove metal items like rings, bracelets and watches when working with batteries. The batteries can produce a short circuit current high enough to weld a ring or the like to metal and, thus, cause a severe burn.
- If you need to remove a battery, always remove the ground (Negative) terminal from the battery first. Make sure that all the accessories are off so that you do not cause a spark.

SECTION 1 | Safety Instructions

1.3 SAFETY INSTRUCTIONS - INVERTER RELATED



WARNING!

Preventing Paralleling of the AC Output

The AC output of the unit should never be connected directly to an Electrical Breaker Panel / Load Centre which is also fed from the utility power / generator. Such a direct connection may result in parallel operation of the different power sources and AC power from the utility / generator will be fed back into the unit which will instantly damage the output section of the unit and may also pose a fire and safety hazard. If an Electrical Breaker Panel / Load Center is fed from this unit and this panel is also required to be fed from additional alternate AC sources, the AC power from all the AC sources (like the utility / generator / this inverter) should first be fed to an Automatic / Manual Selector Switch and the output of the Selector Switch should be connected to the Electrical Breaker Panel / Load Center. Samlex America, Inc. Automatic Transfer Switch Model No. STS-30 is recommended for this application.



CAUTION!

To prevent possibility of paralleling and severe damage to the unit, never use a simple jumper cable with a male plug on both ends to connect the AC output of the unit to a handy wall receptacle in the home / RV.

Preventing DC Input Over Voltage

It is to be ensured that the DC input voltage of these units is up to 34 VDC for PSR-1200-24 and up to 60VDC for PSR-1200-48 to prevent permanent damage to the unit. Please observe the following precautions:

- Ensure that the maximum charging voltage of the external battery charger / alternator / solar charge controller is up to 34 VDC for PSR-1200-24 and up to 60VDC for PSR-1200-48.
- Do not use unregulated solar panels to charge the battery connected to this unit. Under cold ambient temperatures, the output of the solar panel / array may reach higher than the limiting voltages specified above. Always use a charge controller between the solar panel and the battery.
- When using Diversion Charge Control Mode in a charge controller, the solar / wind / hydro source is directly connected to the battery bank. In this case, the controller will divert excess current to an external load. As the battery charges, the diversion duty cycle will increase. When the battery is fully charged, all the source energy will flow into the diversion load if there are no other loads. The charge controller will disconnect the diversion load if the current rating of the controller is exceeded. Disconnection of the diversion load may damage the battery as well as the inverter or other DC loads connected to the battery due to high voltages generated during conditions of high winds (for wind generators), high water flow rates (for hydro generators). It is, therefore, to be ensured that the diversion load is sized correctly to prevent the above over voltage conditions.
- These units are designed to operate from Battery System with nominal voltage of 24 VDC (PSR-1200-24) or 48 VDC (PSR-1200-48). Do not operate these units from a battery system voltage higher / lower than their rated nominal voltages.

Preventing Reverse Polarity on the Input Side

When making battery connections on the input side, make sure that the polarity of battery connections is correct (Connect the Positive of the battery to the Positive terminal of the unit and the Negative of the battery to the Negative terminal of the unit). If the input is connected in reverse polarity, the external DC fuse and the DC fuses inside the inverter will blow and may also cause permanent damage to the inverter.

SECTION 1 | Safety Instructions



CAUTION!

Damage caused by reverse polarity is not covered by warranty.

Use of External Fuse in DC Input Circuit

Use Class-T or equivalent fuse of appropriate capacity within 7" of the battery Positive terminal. This fuse is required to protect DC input cable run from damage due to short circuit along the length of the cable. Please read instructions under Section 8.4.5 - Installation.

SECTION 2 | General Information

2.1. DEFINITIONS

The following definitions are used in this manual for explaining various electrical concepts, specifications and operations:

Peak Value: It is the maximum value of electrical parameter like voltage / current.

RMS (Root Mean Square) Value: It is a statistical average value of a quantity that varies in value with respect to time. For example, a pure sine wave that alternates between peak values of Positive 169.68V and Negative 169.68V has an RMS value of 120 VAC. Also, for a pure sine wave, the RMS value = Peak value \div 1.414.

Voltage (V), Volts: It is denoted by "V" and the unit is "Volts". It is the electrical force that drives electrical current (I) when connected to a load. It can be DC (Direct Current – flow in one direction only) or AC (Alternating Current – direction of flow changes periodically). The AC value shown in the specifications is the RMS (Root Mean Square) value.

Current (I), Amps, A: It is denoted by "I" and the unit is Amperes – shown as "A". It is the flow of electrons through a conductor when a voltage (V) is applied across it. **Frequency (F), Hz:** It is a measure of the number of occurrences of a repeating event per unit time. For example, cycles per second (or Hertz) in a sinusoidal voltage.

Efficiency, (η): This is the ratio of Active Power Output in Watts \div Active Power Input in Watts.

Phase Angle, (φ): It is denoted by " φ " and specifies the angle in degrees by which the current vector leads or lags the voltage vector in a sinusoidal voltage. In a purely inductive load, the current vector lags the voltage vector by Phase Angle (φ) = 90°. In a purely capacitive load, the current vector leads the voltage vector by Phase Angle, (φ) = 90°. In a purely resistive load, the current vector is in phase with the voltage vector and hence, the Phase Angle, (φ) = 0°. In a load consisting of a combination of resistances, inductances and capacitances, the Phase Angle (φ) of the net current vector will be $> 0^\circ < 90^\circ$ and may lag or lead the voltage vector.

Resistance (R), Ohm, Ω : It is the property of a conductor that opposes the flow of current when a voltage is applied across it. In a resistance, the current is in phase with the voltage. It is denoted by "R" and its unit is "Ohm" - also denoted as " Ω ".

Inductive Reactance (X_L), Capacitive Reactance (X_C) and Reactance (X): Reactance is the opposition of a circuit element to a change of electric current or voltage due to that element's inductance or capacitance. Inductive Reactance (X_L) is the property of a coil of wire in resisting any change of electric current through

SECTION 2 | General Information

the coil. It is proportional to frequency and inductance and causes the current vector to lag the voltage vector by Phase Angle (ϕ) = 90° . Capacitive reactance (X_C) is the property of capacitive elements to oppose changes in voltage. X_C is inversely proportional to the frequency and capacitance and causes the current vector to lead the voltage vector by Phase Angle (ϕ) = 90° . The unit of both X_L and X_C is "Ohm" - also denoted as " Ω ". The effects of inductive reactance X_L to cause the current to lag the voltage by 90° and that of the capacitive reactance X_C to cause the current to lead the voltage by 90° are exactly opposite and the net effect is a tendency to cancel each other. Hence, in a circuit containing both inductances and capacitances, the net Reactance (X) will be equal to the difference between the values of the inductive and capacitive reactances. The net Reactance (X) will be inductive if $X_L > X_C$ and capacitive if $X_C > X_L$.

Impedance, Z: It is the vectorial sum of Resistance and Reactance vectors in a circuit.

Active Power (P), Watts: It is denoted as "P" and the unit is "Watt". It is the power that is consumed in the resistive elements of the load. A load will require additional Reactive Power for powering the inductive and capacitive elements. The effective power required would be the Apparent Power that is a vectorial sum of the Active and Reactive Powers.

Reactive Power (Q), VAR: Is denoted as "Q" and the unit is VAR. Over a cycle, this power is alternatively stored and returned by the inductive and capacitive elements of the load. It is not consumed by the inductive and capacitive elements in the load but a certain value travels from the AC source to these elements in the (+) half cycle of the sinusoidal voltage (Positive value) and the same value is returned back to the AC source in the (-) half cycle of the sinusoidal voltage (Negative value). Hence, when averaged over a span of one cycle, the net value of this power is 0. However, on an instantaneous basis, this power has to be provided by the AC source. *Hence, the inverter, AC wiring and over current protection devices have to be sized based on the combined effect of the Active and Reactive Powers that is called the Apparent Power.*

Apparent (S) Power, VA: This power, denoted by "S", is the vectorial sum of the Active Power in Watts and the Reactive Power in "VAR". In magnitude, it is equal to the RMS value of voltage "V" X the RMS value of current "A". The Unit is VA. Please note that Apparent Power VA is more than the Active Power in Watts. *Hence, the inverter, AC wiring and over current protection devices have to be sized based on the Apparent Power.*

Maximum Continuous Running AC Power Rating: This rating may be specified as "Active Power" in Watts (W) or "Apparent Power" in Volt Amps (VA). It is normally specified in "Active Power (P)" in Watts for Resistive type of loads that have Power Factor =1. Reactive types of loads will draw higher value of "Apparent Power" that is the sum of "Active and Reactive Powers". Thus, AC power source should be sized based on the higher "Apparent Power" Rating in (VA) for all Reactive Types of AC loads. If the AC power source is sized based on the lower "Active Power" Rating in Watts (W), the AC power source may be subjected to overload conditions when powering Reactive Type of loads.

Surge Power Rating: During start up, certain loads require considerably higher surge of power for short duration (lasting from tens of millisecs to few seconds) as compared to their Maximum Continuous Running Power Rating. Some examples of such loads are given below:

- **Electric Motors:** At the moment when an electric motor is powered ON, the rotor is stationary (equivalent to being "Locked"), there is no "Back EMF" and the windings draw a very heavy surge of starting current (Amperes) called "Locked Rotor Amperes" (LRA) due to low DC resistance of the windings. For example,

SECTION 2 | General Information

in motor driven loads like Air-conditioning and Refrigeration Compressors and in Well Pumps (using Pressure Tank), the Starting Surge Current / LRA may be as high as 10 times its rated Full Load Amps (FLA) / Maximum Continuous Running Power Rating. The value and duration of the Starting Surge Current / LRA of the motor depends upon the winding design of the motor and the inertia / resistance to movement of mechanical load being driven by the motor. As the motor speed rises to its rated RPM, "Back EMF" proportional to the RPM is generated in the windings and the current draw reduces proportionately till it draws the running FLA / Maximum Continuous Running Power Rating at the rated RPM.

- Transformers (e.g. Isolation Transformers, Step-up / Step-down Transformers, Power Transformer in Microwave Oven etc.): At the moment when AC power is supplied to a transformer, the transformer draws very heavy surge of "Magnetization Inrush Current" for a few milliseconds that can reach up to 10 times the Maximum Continuous Rating of the Transformer.
- Devices like Infrared Quartz Halogen Heaters (also used in Laser Printers) / Quartz Halogen Lights / Incandescent Light Bulbs using Tungsten heating elements: Tungsten has a very high Positive Temperature Coefficient of Resistance i.e. it has lower resistance when cold and higher resistance when hot. As Tungsten heating element will be cold at the time of powering ON, its resistance will be low and hence, the device will draw very heavy surge of current with consequent very heavy surge of power with a value of up to 8 times the Maximum Continuous Running AC Power.
- AC to DC Switched Mode Power Supplies (SMPS): This type of power supply is used as stand-alone power supply or as front end in all electronic devices powered from Utility / Grid e.g. in audio/video/ computing devices and battery chargers (Please see Section 4 for more details on SMPS). When this power supply is switched ON, its internal input side capacitors start charging resulting in very high surge of Inrush Current for a few milliseconds (Please see Fig 4.1). This surge of inrush current / power may reach up to 15 times the Continuous Maximum Running Power Rating. The surge of inrush current / power will, however, be limited by the Surge Power Rating of the AC source.

Power Factor, (PF): It is denoted by "PF" and is equal to the ratio of the Active Power (P) in Watts to the Apparent Power (S) in VA. The maximum value is 1 for resistive types of loads where the Active Power (P) in Watts = the Apparent Power (S) in VA. It is 0 for purely inductive or purely capacitive loads. Practically, the loads will be a combination of resistive, inductive and capacitive elements and hence, its value will be $> 0 < 1$. Normally it ranges from 0.5 to 0.8 e.g. (i) AC motors (0.4 to 0.8), (ii) Transformers (0.8) (iii) AC to DC Switch Mode Power Supplies (0.5 to 0.6) etc.

Load: Electrical appliance or device to which an electrical voltage is fed.

Linear Load: A load that draws sinusoidal current when a sinusoidal voltage is fed to it. Examples are, incandescent lamp, heater, electric motor, etc.

Non-Linear Load: A load that does not draw a sinusoidal current when a sinusoidal voltage is fed to it. For example, non-power factor corrected Switched Mode Power Supplies (SMPS) used in computers, audio video equipment, battery chargers, etc.

Resistive Load: A device or appliance that consists of pure resistance (like filament lamps, cook tops, toaster, coffee maker etc.) and draws only Active Power (Watts) from the inverter. The inverter can be sized based on the Active Power rating (Watts) of resistive type of loads without creating overload (except for resistive type of loads with Tungsten based heating element like in Incandescent Light Bulbs, Quartz Halogen Lights and Quartz Halogen Infrared Heaters. These require higher starting surge power due to lower resistance value when the heating element is cold).

SECTION 2 | General Information

Reactive Load: A device or appliance that consists of a combination of resistive, inductive and capacitive elements (like motor driven tools, refrigeration compressors, microwaves, computers, audio/ video etc.). The Power Factor of this type of load is <1 e.g. AC motors (PF=0.4 to 0.8), Transformers (PF=0.8), AC to DC Switch Mode Power Supplies (PF=0.5 to 0.6) etc. These devices require Apparent Power (VA) from the AC power source. The Apparent Power is a vectorial sum of Active Power (Watts) and Reactive Power (VAR). *The AC power source has to be sized based on the higher Apparent Power (VA) and also based on the Starting Surge Power.*

2.2 OUTPUT VOLTAGE WAVEFORMS

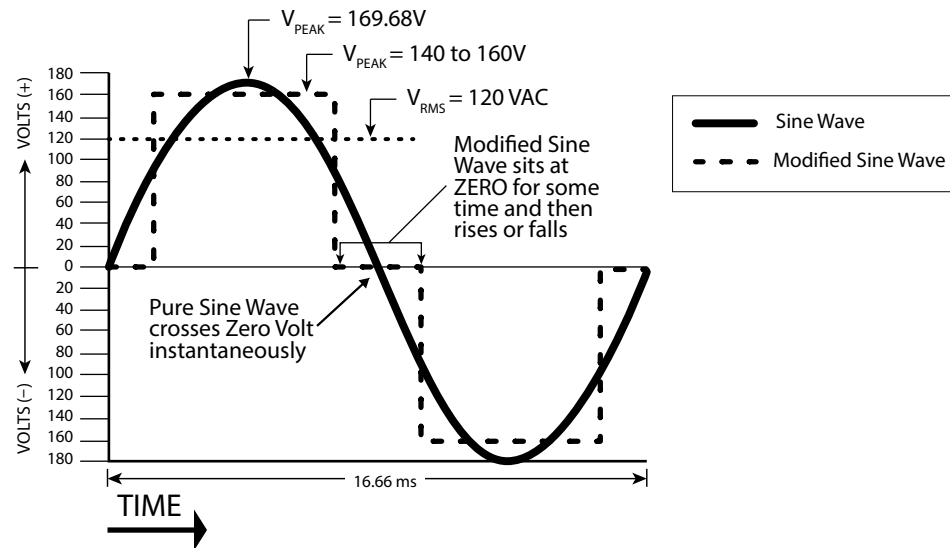

Fig. 2.1: Pure and Modified Sine Waveforms for 120 VAC, 60 Hz

The output waveform of the Samlex PST series inverters is a Pure Sine Wave like the waveform of Utility / Grid Power. Please see Sine Wave represented in the Fig. 2.1 that also shows Modified Sine Waveform for comparison.

In a Sine Wave, the voltage rises and falls smoothly with a smoothly changing phase angle and also changes its polarity instantly when it crosses 0 Volts. In a Modified Sine Wave, the voltage rises and falls abruptly, the phase angle also changes abruptly and it sits at zero V for some time before changing its polarity. Thus, any device that uses a control circuitry that senses the phase (for voltage / speed control) or instantaneous zero voltage crossing (for timing control) will not work properly from a voltage that has a Modified Sine Waveform.

Also, as the Modified Sine Wave is a form of Square Wave, it is comprised of multiple Sine Waves of odd harmonics (multiples) of the fundamental frequency of the Modified Sine Wave. For example, a 60 Hz Modified Sine Wave will consist of Sine Waves with odd harmonic frequencies of 3rd (180 Hz), 5th (300 Hz), 7th (420 Hz) and so on. The high frequency harmonic content in a Modified Sine Wave produces enhanced radio interference, higher heating effect in inductive loads like microwaves and motor driven devices like hand tools, refrigeration / air-conditioning compressors, pumps etc. The higher frequency harmonics also produce overloading effect in low frequency capacitors due to lowering of their capacitive reactance by the higher harmonic frequencies. These capacitors are used in ballasts for fluorescent lighting for Power Factor improvement and in single-phase induction motors as Start and Run Capacitors. Thus, Modified and Square Wave inverters may shut down due to overload when powering these devices.

SECTION 2 | General Information

2.3 ADVANTAGES OF PURE SINE WAVE INVERTERS

- The output waveform is a Sine Wave with very low harmonic distortion and cleaner power like Utility / Grid supplied electricity.
- Inductive loads like microwaves, motors, transformers etc. run faster, quieter and cooler.
- More suitable for powering fluorescent lighting fixtures containing Power Factor Improvement Capacitors and single phase motors containing Start and Run Capacitors
- Reduces audible and electrical noise in fans, fluorescent lights, audio amplifiers, TV, fax and answering machines, etc.
- Does not contribute to the possibility of crashes in computers, weird print outs and glitches in monitors.

2.4 SOME EXAMPLES OF DEVICES THAT MAY NOT WORK PROPERLY WITH MODIFIED SINE WAVE AND MAY ALSO GET DAMAGED ARE GIVEN BELOW:

- Laser printers, photocopiers, and magneto-optical hard drives.
- Built-in clocks in devices such as clock radios, alarm clocks, coffee makers, bread-makers, VCR, microwave ovens etc. may not keep time correctly.
- Output voltage control devices like dimmers, ceiling fan / motor speed control may not work properly (dimming / speed control may not function).
- Sewing machines with speed / microprocessor control.
- Transformer-less capacitive input powered devices like (i) Razors, flashlights, nightlights, smoke detectors etc. (ii) Some re-chargers for battery packs used in hand power tools. These may get damaged. *Please check with the manufacturer of these types of devices for suitability.*
- Devices that use radio frequency signals carried by the AC distribution wiring.
- Some new furnaces with microprocessor control / Oil burner primary controls.
- High intensity discharge (HID) lamps like Metal Halide Lamps. *These may get damaged. Please check with the manufacturer of these types of devices for suitability.*
- Some fluorescent lamps / light fixtures that have Power Factor Correction Capacitors. *The inverter may shut down indicating overload.*
- Induction Cooktops

2.5 POWER RATING OF INVERTERS



INFO

For proper understanding of explanations given below, please refer to definitions of Active / Reactive / Apparent / Continuous / Surge Powers, Power Factor, and Resistive / Reactive Loads at Section 2.1 under "DEFINITIONS".

The power rating of inverters is specified as follows:

- Maximum Continuous Running Power Rating
- Surge Power Rating to accommodate high, short duration surge of power required during start up of certain AC appliances and devices.

SECTION 2 | General Information

Please read details of the above two types of power ratings in Section 2.1 under “DEFINITIONS”



INFO

The manufacturers’ specification for power rating of AC appliances and devices indicates only the Maximum Continuous Running Power Rating. The high, short duration surge of power required during start up of some specific types of devices has to be determined by actual testing or by checking with the manufacturer. This may not be possible in all cases and hence, can be guessed at best, based on some general Rules of Thumb.

Table 2.1 provides a list of some common AC appliances / devices that require high, short duration surge of power during start up. An “Inverter Sizing Factor” has been recommended against each which is a Multiplication Factor to be applied to the Maximum Continuous Running Power Rating (Active Power Rating in Watts) of the AC appliance / device to arrive at the Maximum Continuous Running Power Rating of the inverter (Multiply the Maximum Continuous Running Power Rating (Active Power Rating in Watts) of the appliance / device by recommended Sizing Factor to arrive at the Maximum Continuous Running Power Rating of the inverter.

TABLE 2.1: INVERTER SIZING FACTOR	
Type of Device or Appliance	Inverter Sizing Factor (See note 1)
Air Conditioner / Refrigerator / Freezer (Compressor based)	5
Air Compressor	4
Sump Pump / Well Pump / Submersible Pump	3
Dishwasher / Clothes Washer	3
Microwave (where rated output power is the cooking power)	2
Furnace Fan	3
Industrial Motor	3
Portable Kerosene / Diesel Fuel Heater	3
Circular Saw / Bench Grinder	3
Incandescent / Halogen / Quartz Lamps	3
PTC (Positive Temperature Coefficient) Type Ceramic Heaters	5
Switch Mode Power Supplies (SMPS): no Power Factor correction	2
Photographic Strobe / Flash Lights	4 (See Note 2)

NOTES FOR TABLE 2.1

1. Multiply the Maximum Continuous Running Power Rating (Active Power Rating in Watts) of the appliance / device by the recommended Sizing Factor to arrive at the Maximum Continuous Running Power Rating of the inverter.
2. For photographic strobe / flash unit, the Surge Power Rating of the inverter should be > 4 times the Watt Sec rating of photographic strobe / flash unit.

SECTION 3 | Limiting Electro-Magnetic Interference (EMI)

3.1 EMI AND FCC COMPLIANCE

These inverters contain internal switching devices that generate conducted and radiated electromagnetic interference (EMI). The EMI is unintentional and cannot be entirely eliminated. The magnitude of EMI is, however, limited by circuit design to acceptable levels as per limits laid down in North American FCC Standard – FCC Part 15(B), Class B. The limits laid down in this Standard are designed to provide reasonable protection against harmful radio interference when these units are operated in residential environment. These inverters can conduct and radiate radio frequency energy and, if not installed and used in accordance with the instruction manual, may cause harmful interference to radio communications.

3.2 REDUCING EMI THROUGH PROPER INSTALLATION

The effects of EMI will also depend upon a number of factors external to the inverter like proximity of the inverter to the EMI receptors, types and quality of connecting wires and cables etc. EMI due to factors external to the inverter may be reduced as follows:

- Ensure that the inverter is firmly grounded to the ground system of the building or the vehicle
- Locate the inverter as far away from the EMI receptors like radio, audio and video devices as possible
- Keep the DC side wires between the battery and the inverter as short as possible
- Do NOT keep the battery wires far apart. Keep them taped together to reduce their inductance and induced voltages. This reduces ripple in the battery wires and improves performance and efficiency.
- Shield the DC side wires with metal sheathing / copper foil / braiding:
- Use coaxial shielded cable for all antenna inputs (instead of 300 ohm twin leads)
- Use high quality shielded cables to attach audio and video devices to one another
- Limit operation of other high power loads when operating audio / video equipment

SECTION 4 | Powering Direct / Embedded Switch Mode Power Supplies (SMPS)

4.1 CHARACTERISTICS OF SWITCHED MODE POWER SUPPLIES (SMPS)

Switch Mode Power Supplies (SMPS) are extensively used to convert the incoming AC power into various voltages like 3.3V, 5V, 12V, 24V etc. that are used to power various devices and circuits used in electronic equipment like battery chargers, computers, audio and video devices, radios etc. SMPS use large capacitors in their input section for filtration. When the power supply is first turned on, there is a very large inrush current drawn by the power supply as the input capacitors are charged (The capacitors act almost like a short circuit at the instant the power is turned on). The inrush current at turn-on is several to tens of times larger than the rated RMS input current and lasts for a few milliseconds. An example of the input voltage versus input current waveforms is given in Fig. 4.1. It will be seen that the initial input current pulse just after turn-on is > 15 times larger than the steady state RMS current. The inrush dissipates in around 2 or 3 cycles i.e. in around 33 to 50 milliseconds for 60 Hz sine wave.

Further, due to the presence of high value of input filter capacitors, the current drawn by an SMPS (With no Power Factor correction) is not sinusoidal but non-linear as shown in Fig 4.2. The steady state input current of SMPS is a train of non-linear pulses instead of a sinusoidal wave. These pulses are two to four milliseconds duration each with a very high Crest Factor of around 3 (Crest Factor = Peak value ÷ RMS value).

Many SMPS units incorporate "Inrush Current Limiting". The most common method is the NTC (Negative Temperature Coefficient) resistor. The NTC resistor has a high resistance when cold and a low resistance when hot. The NTC resistor is placed in series with the input to the power supply. The cold resistance limits the input current as the input capacitors charge up. The input current heats up the NTC and the resistance drops during normal operation. However, if the power supply is quickly turned off and back on, the NTC resistor will be hot so its low resistance state will not prevent an inrush current event.

The inverter should, therefore, be sized adequately to withstand the high inrush current and the high Crest Factor of the current drawn by the SMPS. Normally, inverters have short duration Surge Power Rating of 2 times their Maximum Continuous Power Rating. Hence, it is recommended that for purposes of sizing the inverter to accommodate Crest Factor of 3, the Maximum Continuous Power Rating of the inverter should be > 2 times the Maximum Continuous Power Rating of the SMPS. For example, an SMPS rated at 100 Watts should be powered from an inverter that has Maximum Continuous Power Rating of > 200 Watts.

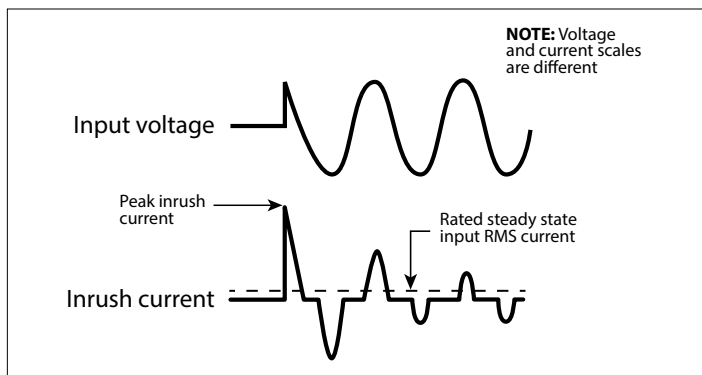

Fig 4.1: Inrush current in an SMPS

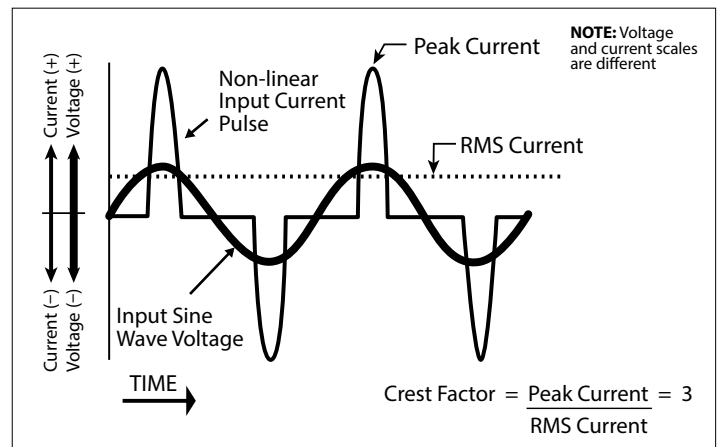

Fig. 4.2: High Crest Factor of current drawn by SMPS

SECTION 5 | Description & Principles of Operation

5.1 GENERAL DESCRIPTION

This unit is a 1200W, 100-120VAC, 50/60Hz Pure Sine Wave Inverter with Transfer Relay and functions as a Backup AC Power Source. Layout of the unit is shown in Figs 6.1 and 6.2. The input side of the unit is connected to 2 power sources: (i) DC power from 24/48VDC battery system and (ii) AC power from 100-120VAC, 50/60 Hz Grid / Generator. It can operate in 2 modes: (i) **Off-Line Mode:** Grid / Generator is the primary source of AC power and the Inverter is standby and (ii) **On-Line Mode:** The DC-AC Inverter is the primary source of AC power and the Grid / Generator is standby.

NOTE: There is no battery charger built into the unit and hence, the batteries feeding the Inverter will be required to be charged through an external battery charger.

Features:

- Micro-controller based, high efficiency, high frequency type Pure Sine Wave Inverter (THD < 2%) with Transfer Switch – ensures highly reliable backup AC power in Off-Line / On-line Modes.
- Backup Inverter has adjustable operating voltage (100-120VAC) and frequency (50/60Hz) to meet country specific requirements
- Option to select Synchronized (Default) / Unsynchronized Transfer. In “Synchronized Transfer” option, the output voltage of the Inverter is kept synchronized in frequency and in phase with the AC input voltage from the Grid / Generator (limited to programmable frequency deviation of up to 7 Hz). This allows safer transfer with faster transfer time of < 8ms.

NOTE: When using Generator or other AC source that have poor frequency stability (frequency deviation of >7 Hz), the Inverter will not be able to synchronize with these input sources and hence, bypass will not be allowed. Unsynchronized Transfer option may be used in this case.

- Space saving 1U height design for 19” Rack Mount Installation
- Operating parameters and modes can be adjusted/ configured and monitored locally or remotely as follows to suit specific application:
 - Local parameter set up and monitoring through LCD Screen / LEDs
 - Remote parameter setup and monitoring through computer terminal using ASCII Coded commands and USB / RS232 Serial Communication
 - Remote monitoring through computer terminal’s Web Browser and Ethernet connection. Further, alarms and faults due to abnormal operating conditions can be notified by e-mail.
 - Remote monitoring through Ethernet / SNMP (Simple Network Management Protocol) Trap messaging
- Wired, remote On/Off control using voltage signal or contact closure
- Wired signaling of alarms / faults through relay contact switching
- Temperature / load controlled cooling fans reduce no load / low load power consumption
- Output Neutral is bonded to the Chassis Ground in Inverter Mode and isolated in AC Grid Bypass Mode. This arrangement meets NEC requirements on grounding
- Safety Listing: ETL listed to UL Standard 62368-1 and CSA Standard C22.2 No. 62368-1
- EMI/EMC Compliance: FCC Part 15(B), Class B

SECTION 5 | Description & Principles of Operation

5.2 POWER SECTIONS OF THE SYSTEM

The unit consists of 2 Power Sections – (i) DC to AC Inverter Section and (ii) Transfer Relay Section.

AC / DC input and output power arrangements are as follows:

- 100-120VAC, 50/60Hz from the Grid / Generator is fed to the unit through 120VAC Male Power Inlet Connector IEC 60320 C14 (18, Fig 6.2). The AC input is protected against over current through 12A Breaker (19, Fig 6.2)
- DC power from 24V / 48VDC battery bank is fed to the DC Input Terminals (10, 11 at Fig 6.2) through external fuse
- AC output power is fed through NEMA5-20 Duplex AC outlet (17, Fig 6.2)

5.3 DC-AC INVERTER SECTION

The Inverter Section is a micro-controller based, high efficiency, Pure Sine Wave Inverter (THD < 2%). It converts 24V / 48V DC voltage from batteries to 120VAC, 50/60Hz AC voltage (Default). The AC output voltage is programmable within a range of 100 to 120VAC (Default is 120VAC) and the AC output frequency is programmable within a range of 45 to 65 Hz (Default is 60Hz). This enables its usage in multiple countries with national Grid voltages ranging from 100 to 120VAC and 50/60 Hz frequency (e.g. North America, Taiwan, Japan etc).

DC to AC voltage conversion takes place in two stages. In the First Stage, the DC voltage of the battery is converted to high voltage DC using high frequency switching and PWM (Pulse Width Modulation) technique. In the second stage, the high voltage DC is converted to 120VAC (Default), 60Hz (Default) pure sine wave AC again using PWM technique. This is done by using special wave shaping technique where the high voltage DC is switched at high frequency and the pulse width of switching is modulated with respect to reference sine wave. High frequency components are then filtered to get modulated pure sine wave form.

5.3.1 No Load Draw / Idle Current in Inverter Mode

When the Inverter Section is turned ON, all the circuitry in the Inverter Section becomes alive. In this condition, even when no load is being supplied by the Inverter Section (or if the load is connected but has not been switched ON), it draws a small amount of current from the batteries to keep the circuitry alive and ready to deliver the required power on demand. This current is called the “No Load Current” or the “Idle Current” of the Inverter Section. The specified values for this current are as follows”:

- PSR-1200-24: < 0.6A
- PSR-1200-48: < 0.5A



INFO

When the Inverter Section is turned OFF but AC GRID input is still available, AC GRID input voltage will be bypassed to the load through the closed contacts of the energized Relays RL-1 and RL-2 and the Normally Closed (NC) contacts of the de-energized Relays RL-4 and RL-5(see Fig. 5.1). Relays RL-1 and RL-2 are energized by +12VDC generated by a small Switch Mode Power Supply (SMPS) that is powered from the AC GRID input and NOT from the batteries. Hence, in this condition, there will be no current draw from the batteries.

SECTION 5 | Description & Principles of Operation

5.4 TRANSFER RELAY SECTION

In this unit, set of Transfer Relays are used to (i) switch the AC load between the AC GRID and the Inverter (Section 5.4.1) and (ii) to switch Neutral to Chassis Ground bonding i.e. bond the Output Neutral to the Chassis Ground in Inverter Mode and unbind when in Bypass Mode (Section 5.4.3). Connection diagram of these relays is shown in Fig 5.1 below:

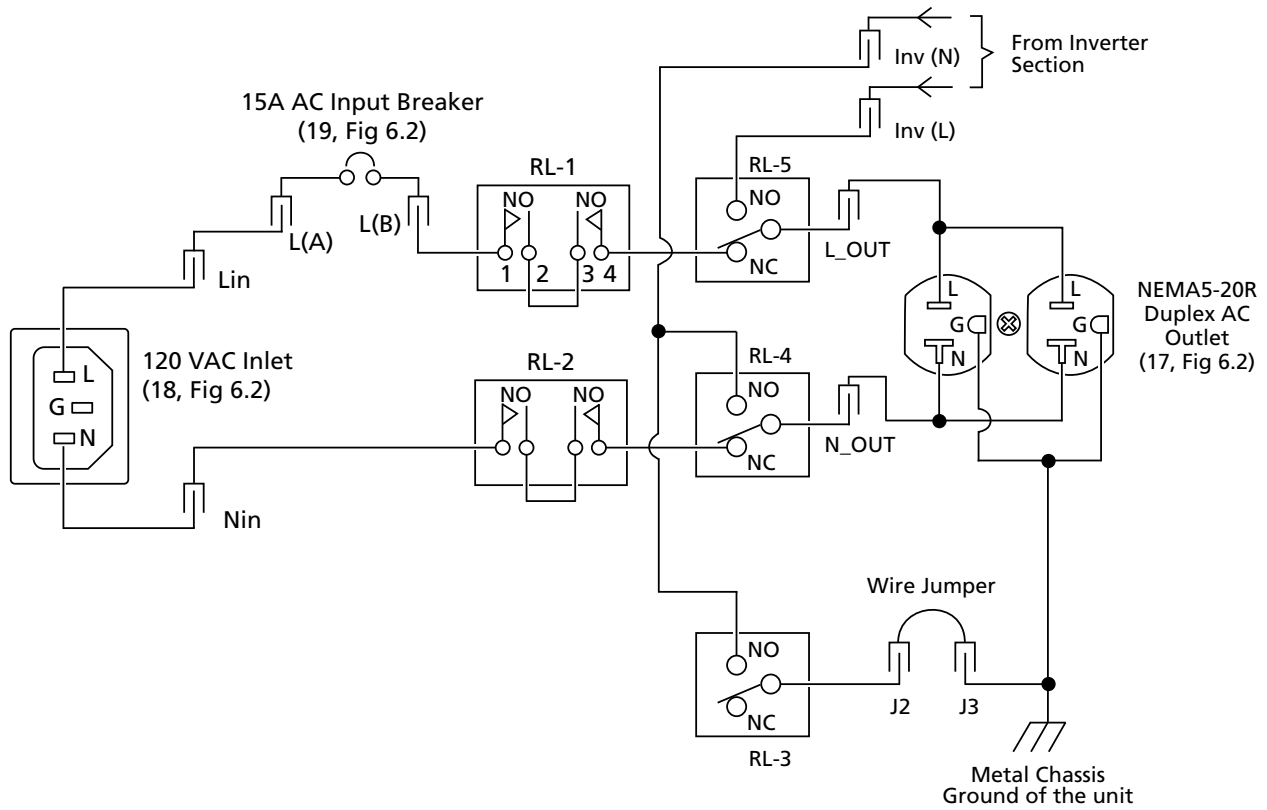

Fig. 5.1: Connection Diagram of Transfer & N-G Bond Switching Relays

LEGEND FOR FIG 5.1

Item	Description
RL-1, RL-2	(i) Relay - Double Pole, Normally Open (DPNO, Contact Form 2A): 16A, 250 VAC (ii) Energized as soon as AC GRID input is available [These 2 relays are powered by 12 VDC Switched Mode Power Supply (SMPS) fed from AC GRID input and not from 24V / 48V Inverter Battery]
RL-3	(i) Relay - Single Pole Double Throw (SPDT, Contact Form 1C); 16A, 240 VAC (ii) Energized when Inverter is supplying the load. When energized, it bonds the output Neutral to the metal chassis Ground of the unit.
RL-4, RL-5	(i) Relay - Single Pole Double Throw (SPDT, Contact Form 1C); 16A, 240 VAC (ii) Energized when the Inverter is supplying the load
NO	Normally open contact of relay
NC	Normally closed contact of relay

SECTION 5 | Description & Principles of Operation

LEGEND FOR FIG 5.1 (Continued)

Item	Description
Lin, Nin, L(A), L(B), Inv(L), Inv(N), J2, J3	Quick Disconnect terminals on internal circuit board marked "120SU_TRANSFER SWITCH"
Wire Jumper	Removable wire jumper located inside the unit on circuit board marked "120SU_TRANSFER SWITCH" Remove this Jumper when the Output Neutral of the NEMA5-20R outlet is required to be permanently isolated from the metal chassis Ground of the unit.
L	Line terminal of AC Inlet / Outlet
N	Neutral terminal of AC Inlet / Outlet
G	Metal Chassis Ground of AC Inlet / Outlet

5.4.1 Relays RL-4 and RL-5 for Switching Load Between AC Grid and Inverter

Refer to Fig 5.1.

Transfer of AC load between AC GRID and Inverter is carried out by switching both the Line (L) and Neutral (N) conductors. Relay RL-5 is used for switching the Line (L) side and Relay RL-4 is used for switching the Neutral (N) side. Both the relays are Single Pole Double Throw (SPDT) rated at 16A, 250VAC

These 2 relays will be in de-energized condition when AC GRID input is being bypassed to the load. They will be energized when the load is required to be fed from the Inverter

5.4.2 Relays RL-1 and RL-2 for Isolation Clearance Requirement

Refer to Fig 5.1.

Relays RL-1[for Line (L) side] and RL-2 [for Neutral (N) side] are in de-energized condition if AC GRID input is NOT available. These 2 relays will be energized as soon as AC GRID is available [irrespective of the position of the Front Panel On/Off Rocker Switch (1, Fig 6.1)]. 12VDC power for energization of these 2 relays is supplied by internal Switched Mode Power Supply (SMPS) that is fed from the AC GRID input. As these relays will be powered by the AC GRID input, their energization will not drain any DC power from the 24V/48V battery system used to power the Inverter Section.

Relays RL-1 and RL-2 are Double Pole, Normally Open (NO) [DPNO] type of relays with contact gap of 2.1 mm. 2 pairs of contacts (1, 2 and 3,4) are connected in series to provide higher effective air gap of 4.2 mm between the Grid side and the Inverter Side to meet UL isolation clearance requirement of > 3.2 mm. As per Table 3 of UL Standard UL 1008 for Transfer Switch Equipment, air gap of >3.2 mm is required to prevent output voltage from the Inverter to leak into the AC GRID during AC GRID failure. When AC GRID failure occurs, a portion of the AC GRID is not energized. This non energized portion of the AC GRID is called "island". If AC power from the Inverter is leaked to the non-energized AC GRID "island" due to lower air gap, it might cause utility personnel who are working on the non-energized AC GRID "island" to be electrocuted.

SECTION 5 | Description & Principles of Operation



WARNING!

If AC GRID input is being fed to the unit through AC Inlet (18, Fig 6.2) and has been switched ON, it will be bypassed to the AC outlets (17, Fig 6.2) even if the Inverter Section has been switched OFF either through the 3-Position Rocker Switch (1, Fig 6.1) or through the Wired Remote On/Off Control (Section 5.7). See explanation below:

As soon as AC GRID input is available, Relays RL-1 and RL-2 will get energized (even if the Inverter Section has been switched OFF either through the 3-Position Rocker Switch or through the Wired Remote On/Off Control). Normally Open (NO) contact pairs 1-2 and 3-4 will be closed. As the Inverter section is OFF / not supplying the load, the Normally Closed (NC) contacts of Relays RL-4 and RL-5 will bypass the AC GRID input voltage to the AC Outlets (17, Fig 6.2).

5.4.3 Relay for Switching Bond between Output Neutral and Equipment Ground (Metal Chassis of PSR)

Refer to connections of Relay RL-3 in Fig 5.1.

Relay RL-3 is a Single Pole Double Throw (SPDT) rated at 16A, 250VAC.

When the unit is used as an independent Inverter with no input connection to the AC GRID, it will be considered as a "Separately Derived System" as per Article 250 of the National Electrical Code (NEC). As per this Code, the Neutral Conductor of the Inverter output has to be bonded to its Equipment Ground (metal chassis of the unit). The Equipment Ground (metal chassis of the unit) has to be connected to the Earth Ground through the Grounding Terminal (16, Fig 6.2) so that in case of a Ground fault, the Inverter will be able activate its over-current shut down protection. However, if the unit is being used as a UPS and is fed from AC GRID Supply Panel, it will be considered "NOT Separately Derived System" but as a "downstream load" as far as the AC GRID Supply Panel is concerned. The AC GRID Supply Panel will have its Neutral bonded to the Earth Ground (through the Ground Rod). As per NEC, it is not permitted to bond the Neutral and Equipment Ground (metal chassis) of any down-stream load being fed from the AC GRID Supply Panel. To meet the above requirements, Relay RL-3 is energized only when the Inverter is supplying power i.e. when Transfer Relays RL-4 and RL-5 are energized (See Section 5.4.1).

Permanent isolation of Output Neutral from metal Chassis Ground: In certain applications, it may be necessary to isolate the Output Neutral from the metal chassis ground permanently. For this requirement, remove the internal Wire Jumper connecting Terminals J2 and J3 (Fig 5.1) [will require removal of top cover of the unit to access this Wire Jumper].

5.5 OFF-LINE AND ON-LINE MODES OF OPERATION THROUGH PROGRAMMABLE PARAMETER "INVERTER MODE"

This unit consists of an Inverter and a set of Transfer Relays as described at Section 5.4. It is designed to function as an Uninterruptible Power Supply (UPS) System where the load will be supplied either by the external AC GRID input or by the internal Inverter. Option is available through programmable parameter called "Inverter Mode" to select one of these 2 AC power sources as the Primary Source and the other as the Backup Source. Programmable options available are as follows:

5.5.1 Off-line Mode: This is the Default Mode. In this mode, the external AC GRID input is the Primary Source of power and the Inverter is the Backup Source.

SECTION 5 | Description & Principles of Operation

For details of programming this mode, please refer to Fig 10.1 / Table 10.1 under Main Menu for Parameter Group 3 – "Output Setup" / Sub Menu for Parameter Group 3, Parameter (d) – "Inverter Mode" (Section 10.2.3.4).

Off-line Mode is so-called because the load is fed directly from the raw AC GRID input during normal operation, rather than from the conditioned Inverter output. To that extent, the energy storage components – charger (not included in this unit and is to be provided externally), battery and Inverter – are off-line as far as the load is concerned, although the charger and battery remain connected to the AC GRID input to ensure that the battery is always fully charged. If the AC GRID input voltage fails, or exceeds the limits of "synchronizable frequency window" determined by the programmable parameter "SyncFREQ" (see Section 5.6.4), the load is transferred to the backup Inverter almost immediately. During this changeover, there is an inevitable break in power to the load of < 8 ms. In practice, most loads can hold up through this period without any problems.

A more serious objection to Off-line Mode is that the load is continuously exposed to spikes, transients and any other aberrations coming down the AC GRID input, creating a risk of loss or damage to sensitive equipment and data.

5.5.2 On-line Mode: In this mode, the Inverter is the primary source of power and the AC GRID input is the backup source of power.

For details of programming this mode please refer to Fig 10.1 / Table 10.1 under Main Menu for Parameter Group 3 – "Output Setup" / Sub Menu for Parameter Group 3, Parameter (d) – "Inverter Mode" (Section 10.2.3.4).

As compared to the Off-line Mode described at Section 5.5.1 above, in On-line Mode, the AC load is supplied by the conditioned power from the Inverter rather than raw, unconditioned power from the AC GRID input. On-line Mode is often called 'Double Conversion' type because incoming power is converted once to DC, for the battery, and then back to AC by the Inverter before reaching the load – which is, therefore, well-insulated from the AC GRID input. In case the Inverter voltage fails, the load is transferred to the backup provided by AC GRID input.

5.6 SYNCHRONIZED AND UNSYNCHRONIZED TRANSFER THROUGH PROGRAMMABLE PARAMETER "TRANSFER TYPE"

5.6.1 This unit is designed to function as an Uninterruptible Power Supply (UPS) System. In a UPS, there is Primary AC Source that supplies the load through a Transfer Switch and a Backup AC Source that takes over the load when the load is transferred from the Primary AC Source to the Backup AC Source.

Programmable parameter called "Transfer Type" has been provided to select either "Synchronized" or "Unsynchronized" transfer. "Synchronized" Type is the default selection. For programming details, refer to Fig 10.1 / Table 10.1 under Main Menu for Parameter Group 3 – "Output Setup" / Sub Menu for Parameter Group 3, Parameter (e) – "Transfer Type" (Section 10.2.3.5).

5.6.2 Synchronized Transfer and Advantages

When current flowing through inductive type of loads such as transformers, fans, pumps, compressors etc. is interrupted, the inductive components of the load generate back EMF voltage at the load terminals. This back EMF voltage is at the same frequency as the AC input source and will dissipate within a finite time of up to hundreds of millisecs. Assume that Primary AC Source is supplying current to the above inductive type

SECTION 5 | Description & Principles of Operation

of loads and this load is required to be transferred to the Backup AC Source. When contacts of Transfer Switch open, current flow in the inductive components of the load will be interrupted creating back EMF voltage at the same frequency as the Primary AC Source. For faster load transfer to the Backup AC Source (before the above back EMF is dissipated), it is desirable that the frequency and phase of the Backup AC Source are kept synchronized with the frequency and phase of the Primary AC Source at all times. If faster transfer takes place from the Primary AC Source to the Backup AC Source that is NOT synchronized in frequency and in phase with the Primary AC Source, AC motor driven loads such as fans, pumps, compressors etc. will experience mechanical stresses and can produce large inrush currents resulting in malfunction of the motor and the motor driven load and unintended tripping of upstream circuit breakers.

All Switch Mode Power Supplies (SMPS) or equipment that have SMPS in their front end experience no difficulties when their primary / backup AC input power sources are switched, regardless of whether the sources are synchronized or not because the entire SMPS / equipment load is supplied at DC (Direct Current).

5.6.3 Programmable Parameter "Output FREQ"

The output frequency of the Inverter can be programmed through parameter called "Output FREQ". Programmable range is 45.0 to 65.0 Hz. Default value is 60Hz. For programming details, refer to Fig 10.1 / Table 10.1 under Main Menu Parameter Group 3 – "Output Setup" / Sub Menu for Parameter Group 3, Parameter (b) – "OUTPUT FREQ" (Section 10.2.3.2).

5.6.4 Programmable Parameter "Sync FREQ" for Determining Synchronizable Frequency Window

As described in Section 5.6.2 above, for safer and faster transfer of load between 2 AC sources, it is desirable that the frequency and phase of the Backup Power Source i.e. the Inverter in this unit be kept synchronized with the AC GRID input at all time. This unit has been designed to provide "synchronized transfer" in the default condition.

Synchronized transfer is possible as long as the frequency of the AC GRID input is within programmable "Synchronizable Frequency Window". This window is determined by programmable parameter called "Sync FREQ" with a range of 0.1 to 7 Hz (Default value is 5 Hz). For programming details, refer to Fig 10.1 / Table 10.1 under Main Menu Parameter Group 3 – "Output Setup" / Sub Menu for Parameter Group 3, Parameter (c) – "SYNC FREQ" (Section 10.2.3.3).

"Synchronizable Frequency Window" = Programmed value of "Output FREQ" of the Inverter +/- Programmed value of the "Sync FREQ". For example, if the "Output Frequency" of the Inverter Section is set at 60 Hz (Default) and "Sync. FREQ" is set at 5 Hz (Default), the "Synchronizable Frequency Window" will be 60Hz ± 5Hz or "55Hz to 65Hz".

As long as the AC GRID input frequency is within the "Synchronizable Frequency Window", the frequency and phase of the Inverter's output voltage will be kept synchronized with the frequency and phase of the AC GRID input.

5.6.5 Synchronized Type of Transfer

5.6.5.1 Synchronized Type of Transfer in Off-Line Mode: Under this condition, AC GRID input is the Primary Source and the Inverter is the Backup Source. Please refer to information in Table 5.1 below related to this condition:

SECTION 5 | Description & Principles of Operation

TABLE 5.1 SYNCHRONIZED TYPE OF TRANSFER IN OFF-LINE MODE		
Condition of AC GRID input	Operation when AC GRID input is operating normally	Operation when AC GRID input fails and is restored subsequently
Frequency of AC GRID input voltage is within the "Synchronizable Frequency Window" determined by the parameter "SyncFREQ" (see Section 5.6.4)	<p>AC GRID input will be the Primary AC Source and the Inverter will be the Backup AC Source.</p> <p>The load will be powered by the AC GRID input.</p> <p>The frequency and phase of Inverter voltage will be kept synchronized with the frequency and phase of the AC GRID input voltage .</p> <p>LED marked "AC GRID" Green LED marked "INVERTER" Green LED marked "BYPASS" Green LED marked "ALARM" Off</p>	<p>AC GRID input failure If the AC GRID input fails, the load will be transferred to the Inverter in synchronized manner (within < 8 ms, <u>NOT at zero crossing</u>)</p> <p>LED marked "AC GRID" Off LED marked "INVERTER" Green LED marked "BYPASS" Off LED marked "ALARM" Off</p> <p>AC GRID input voltage is restored If and when AC GRID input is restored, the frequency and phase of the Inverter voltage will be slowly synchronized with the frequency and phase of the AC GRID input voltage. When synchronization is completed, the load will be transferred back to the AC GRID input <u>at zero crossing</u> of the voltage waveform within < 8 ms</p>
Frequency of AC GRID input voltage is NOT within the "Synchronizable Frequency Window" determined by the parameter "SyncFREQ" (see Section 5.6.4)	<p>AC GRID input will be the Primary AC Source and the Inverter will be the Backup AC Source.</p> <p>As the AC GRID input is <u>NOT</u> within the "Synchronizable Frequency Window", it will <u>NOT</u> be bypassed. <u>The load will be supplied by the Inverter.</u></p> <p>The frequency of Inverter voltage will be adjusted to a value <u>NOT</u> equal to but closer to value = ("Output FREQ" + "Sync FREQ" or "Output FREQ" - "Sync FREQ"). For example, if "Output FREQ" of the Inverter = 60Hz, "Sync FREQ"=5 Hz and AC GRID input frequency = 50Hz, then the Inverter frequency will be 55 Hz (60Hz – 5 Hz = 55Hz).</p> <p>LED marked "AC GRID" Orange LED marked "INVERTER" Green LED marked "BYPASS" Off LED marked "ALARM" Off</p>	<p>AC GRID input failure If AC GRID input fails, it will not matter because the load was already being powered by the Inverter as the AC GRID input was <u>NOT</u> within the "Synchronizable Frequency Window".</p> <p>LED marked "AC GRID" Off LED marked "INVERTER" Green LED marked "BYPASS" Off LED marked "ALARM" Off</p> <p>AC GRID input is restored If and when AC GRID input is restored, the frequency of Inverter voltage will be adjusted to a value <u>NOT</u> equal to but closer to value = ("Output FREQ" + "Sync FREQ" or "Output FREQ" - "Sync FREQ"). For example, if "Output FREQ" of the Inverter = 60Hz, "Sync FREQ"=5 Hz and AC GRID input frequency = 50Hz, then the Inverter frequency will be 55 Hz (60Hz – 5 Hz = 55Hz).</p> <p>The load will continue to be powered by the Inverter at frequency closest to the AC GRID input frequency as described above.</p>

SECTION 5 | Description & Principles of Operation

5.6.5.2 Synchronized Type of Transfer in On Line Mode: Under this condition, Inverter is the Primary Source and the AC GRID input is the Backup Source. Please refer to information in Table 5.2 below related to this condition:

TABLE 5.2 SYNCHRONIZED TYPE OF TRANSFER IN ON-LINE MODE		
Condition of AC GRID input	Operation when Inverter is operating normally	Operation when Inverter fails and auto resets subsequently
Frequency of AC GRID input voltage is within the "Synchronizable Frequency Window" determined by the parameter "SyncFREQ" (see Section 5.6.4)	<p>Inverter will be the Primary AC Source and AC GRID input will be the Backup AC Source.</p> <p>The load will be powered by the Inverter.</p> <p>The frequency and phase of Inverter voltage will be kept synchronized with the frequency and phase of the AC GRID input voltage.</p> <p>LED marked "AC GRID" Green LED marked "INVERTER" Green LED marked "BYPASS" Off LED marked "ALARM" Off</p>	<p>Inverter failure If the Inverter fails, the load will be transferred to the AC GRID input in synchronized manner.</p> <p>LED marked "AC GRID" Green LED marked "INVERTER" Red LED marked "BYPASS" Green LED marked "ALARM" Orange</p> <p>Inverter reset If and when the Inverter resets automatically, the frequency and phase of its voltage will be slowly synchronized with the frequency and phase of the AC GRID input voltage. When synchronization is completed, the load will be transferred back to the Inverter at zero crossing of the voltage waveform within < 8 ms</p>
Frequency of AC GRID input voltage is NOT within the "Synchronizable Frequency Window" determined by the parameter "SyncFREQ" (see Section 5.6.4)	<p>Inverter will be the Primary AC Source and AC GRID input will be the Backup AC Source.</p> <p>The load will be supplied by the Inverter at a frequency that is closest to the AC GRID frequency as described below.</p> <p>The frequency of Inverter voltage will be adjusted to a value <u>NOT</u> equal to but closer to value = ("Output FREQ" + "Sync FREQ" or "Output FREQ" - "Sync FREQ"). For example, if "Output FREQ" of the Inverter = 60Hz, "Sync FREQ"=5 Hz and AC GRID input frequency = 50Hz, then the Inverter frequency will be 55 Hz (60Hz – 5 Hz = 55Hz).</p> <p>LED marked "AC GRID" Orange LED marked "INVERTER" Green LED marked "BYPASS" Off LED marked "ALARM" Off</p>	<p>Inverter Failure If Inverter fails, transfer to the AC GRID input will NOT be carried out because the AC GRID input is NOT within the "Synchronizable Frequency Window".</p> <p><u>The load will lose AC power</u></p> <p>LED marked "AC GRID" Orange LED marked "INVERTER" Red LED marked "BYPASS" Off LED marked "ALARM" Orange</p> <p>Inverter Reset If and when the Inverter resets automatically, the frequency of Inverter voltage will be adjusted to a value <u>NOT</u> equal to but closer to value = ("Output FREQ" + "Sync FREQ" or "Output FREQ" - "Sync FREQ"). For example, if "Output FREQ" of the Inverter = 60Hz, "Sync FREQ"=5 Hz and AC GRID input frequency = 50Hz, then the Inverter frequency will be 55 Hz (60Hz – 5 Hz = 55Hz).</p> <p>After the Inverter frequency is brought closest to the AC GRID frequency as described above, the load will be transferred back to the Inverter.</p>

SECTION 5 | Description & Principles of Operation

5.6.6.2 Unsynchronized Type of Transfer in On-Line Mode: Under this condition, Inverter is the Primary Source and the AC GRID input is the Backup Source. Please refer to information in Table 5.4 below related to this condition:

TABLE 5.4 UNSYNCHRONIZED TYPE OF TRANSFER IN ON-LINE MODE		
Condition of AC GRID input	Operation when Inverter input is operating normally	Operation when Inverter fails and is restored subsequently
<p>Frequency of AC GRID input voltage may or may NOT be within the "Synchronizable Frequency Window" determined by the parameter "SyncFREQ" (see Section 5.6.4).</p>	<p>Inverter will be the Primary AC Source and the AC GRID input will be the Backup AC Source.</p> <p>Load will be supplied by the Inverter. Inverter output frequency will be FIXED at the programmed value of parameter "Output FREQ" (Default value is 60Hz).</p> <p>Frequency of AC GRID input will be checked if within the "Synchronizable Frequency Window".</p> <p>LED marked "AC GRID" Green/ Orange*</p> <p>LED marked "INVERTER" Green</p> <p>LED marked "BYPASS" Off</p> <p>LED marked "ALARM" Off</p> <p>* Green if AC GRID input frequency is within the "Synchronizable Frequency Window" determined by the parameter "Sync FREQ" (see Section 5.6.4).</p> <p>* Orange if AC GRID input frequency is NOT within the "Synchronizable Frequency Window" determined by the parameter "Sync FREQ" (see Section 5.6.4).</p>	<p>Inverter failure If Inverter fails, the load will be transferred to the AC GRID input. Frequency of AC GRID input voltage may or may NOT be within the "Synchronizable Frequency Window" determined by the parameter "SyncFREQ" (see Section 5.6.4).</p> <p>LED marked "AC GRID" Green/ Orange*</p> <p>LED marked "INVERTER" Red</p> <p>LED marked "BYPASS" Green</p> <p>LED marked "ALARM" Orange</p> <p>* Green if AC GRID input frequency is within the "Synchronizable Frequency Window" determined by the parameter "Sync FREQ" (see Section 5.6.4).</p> <p>* Orange if AC GRID input frequency is NOT within the "Synchronizable Frequency Window" determined by the parameter "Sync FREQ" (see Section 5.6.4).</p> <p>Inverter is reset If and when the Inverter resets automatically, its output frequency will be fixed at the programmed value of parameter "Output FREQ" (Default value is 60Hz) and then, the load will be transferred back to the Inverter.</p>

5.7 WIRED REMOTE ON / OFF CONTROL FOR INVERTER SECTION

The Inverter Section can be switched ON and OFF using wired remote ON / OFF control. For this, terminals ENB, GND and ENB have been provided in the 7-Way Terminal Block at the rear of the unit (12, Fig 6.2).

IMPORTANT NOTE: For activation of wired remote ON / OFF function, the 3-Position Rocker Switch on the Front Panel (1, Fig 6.1) has to be pressed down towards position marked "EXT. Switch".

4 different methods of control are described in the succeeding Sections 5.7.1 to 5.7.4.

SECTION 5 | Description & Principles of Operation

5.7.1 1-Wire Remote ON / OFF Control using ENB Terminal

Refer to Fig 5.2

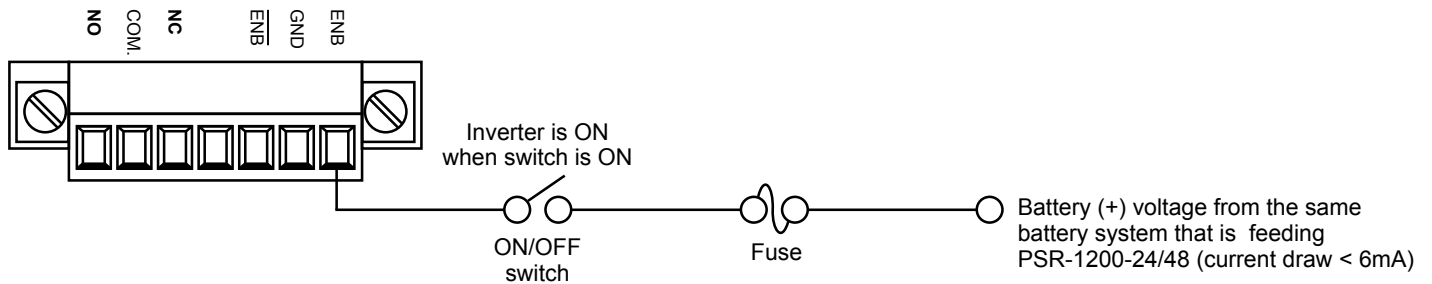

Fig 5.2 1-Wire Remote ON / OFF Control using ENB Terminal

5.7.2 2-Wire Remote ON / OFF Control using $\overline{\text{ENB}}$ and GND Terminals

Refer to Fig 5.3

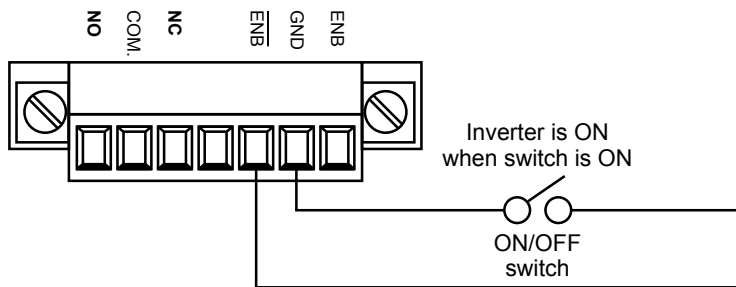

Fig 5.3 2-Wire Remote Control ON / OFF using $\overline{\text{ENB}}$ and GND Terminals

5.7.3 2-Wire Remote ON / OFF Control using ENB and GND Terminals and External DC Power Source

Refer to Fig 5.4

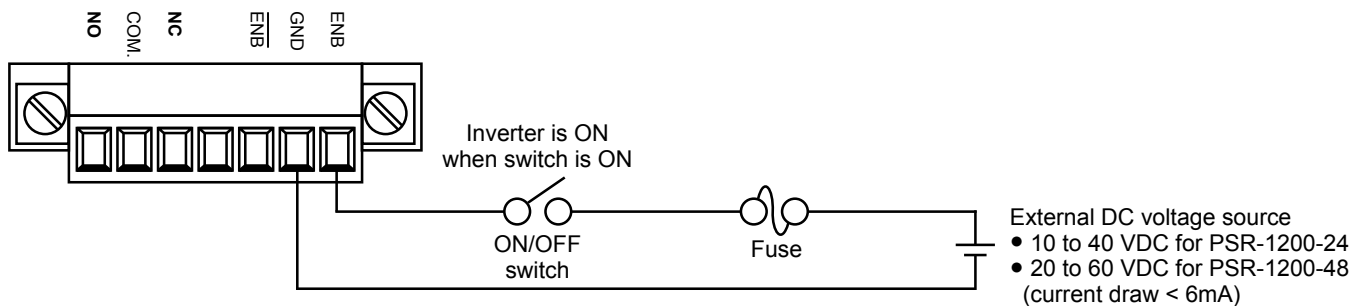

Fig 5.4 2-Wire Remote Control ON / OFF using ENB and GND Terminals and External DC Power Source

SECTION 5 | Description & Principles of Operation

5.7.4 2-Wire Remote ON / OFF Control using $\overline{\text{ENB}}$ Terminals and External Transistor Switch

Refer to Fig 5.5

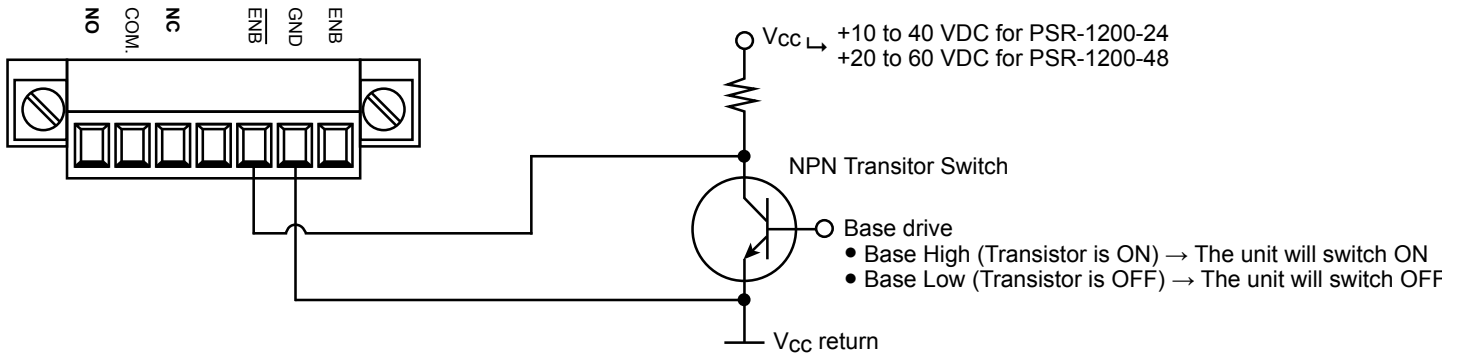

Fig 5.5 2-Wire Remote Control ON / OFF using $\overline{\text{ENB}}$ and GND Terminals and External Transistor Switch

5.8 2-WIRE REMOTE MONITORING OF ALARMS / FAULTS

A Single Pole Double Throw (SPDT) relay with Normally Open (NO), Common and Normally Closed (NC) contacts has been provided to enable 2-wire remote monitoring of the following 6 alarm / fault conditions through contact switching (See Fig 5.6 below):

1. Fan Fault;
2. Over Voltage (OV) Alarm;
3. Under Voltage (UV) Alarm;
4. Overload Shut Down;
5. Over Temperature Shut Down;
6. Short Circuit Shut Down

The relay contacts may be used to switch external monitoring circuits of up to 277 VAC, 16A.

The relay can be programmed through Parameter "Relay Setup" to energize when any one or combination of the above 6 Alarm / Fault conditions is "Enabled". The Default setting is "Enabled" for all 6 conditions which means that the relay will energize due to any one or a combination of the 6 possible abnormal conditions. For programming details, refer to Fig 10.1 / Table 10.1 under Main Menu for Parameter Group 1 – "UI Setting" / Sub Menu for Parameter Group 1, Parameter (f) – "Relay Setup" (Section 10.2.1.6).

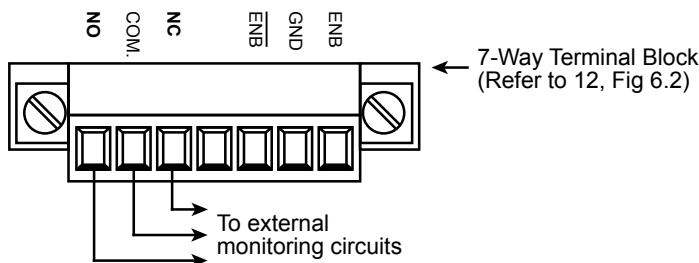

Fig 5.6 NO, COM & NC Relay contacts for external monitoring circuits

SECTION 6 | Layout

6.1 LAYOUT

Layouts of the Front and Back Panels are shown in Figs 6.1 and 6.2 below:

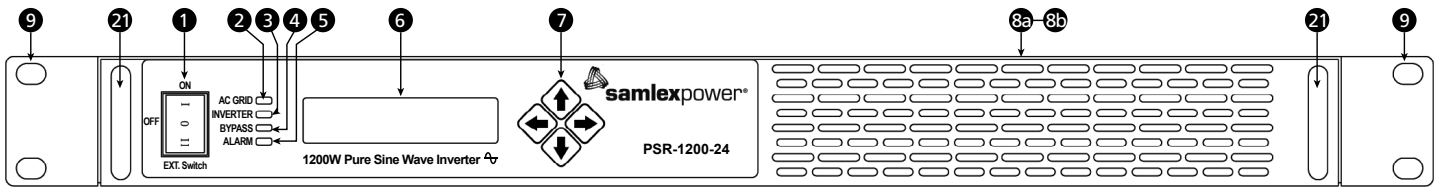

Fig 6.1 Front view and layout of Front Panel (With mounting brackets)

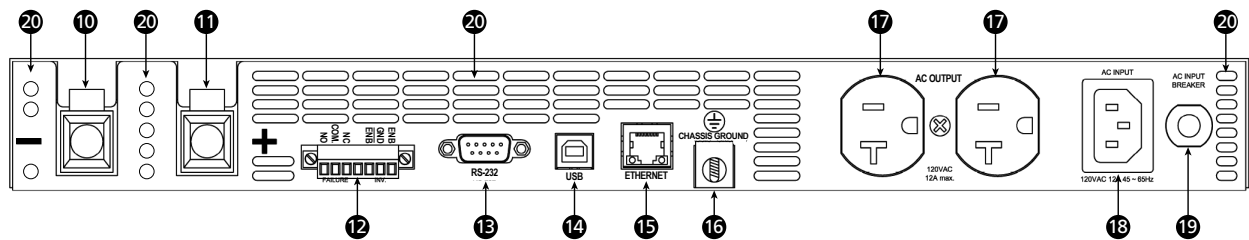

Fig 6.2 Rear view and layout of Rear Panel (Without mounting brackets)

LEGEND FOR FIGS 6.1 AND 6.2

1. 3-Position Rocker Switch
 - i. **OFF:** (Centre position). Switches OFF the Inverter Section when under manual On/Off control
 - ii. **ON:** (Press top portion). Switches ON the Inverter Section when under manual On/Off control
 - iii. **EXT. Switch** (Press bottom portion). Activates External On/Off Control of the Inverter Section
2. 2-Color Status LED marked "AC GRID" – Green / Orange
3. 2-Color Status LED marked "INVERTER" – Green or Red
4. Single color Status LED marked "BYPASS" – Green
5. Single Color Status LED marked "ALARM" – Orange
6. LCD Display: 2 lines of 16 characters each
7. Display Selection Keys for navigating through the LCD Display Screens and for programming
- 8(a). Air inlet slots for 3 cooling fans (fans located behind the slots – not visible)
- 8(b). 3 cooling fans located behind the inlet slots 8(a) [the fans are not visible from outside]
9. Mounting brackets for rack-mount installation
10. Negative (-) DC Input Terminal } Cylindrical hole with Set Screw (i) Hole Diameter: 7/16",
11. Positive (+) DC Input Terminal } (ii) Set Screw: 5/16" X 24TPI; 1/2" Length; Slotted Head
12. 7-Way Terminal Block: (i) Moving cage clamp terminals (ii) Terminal hole size: 3mm x 2.5mm. The terminal block is used for the following:
 - a) 3 terminals marked "ENB, GND and ENB" for wired remote On / Off control:
 - b) 3 terminals marked "NO, COM and NC" for SPDT relay output connections for remote signaling of alarm / fault conditions
13. 9-pin DB-9 Connector for RS-232 communication
14. USB Type "B" Jack for USB connection
15. RJ-45 Jack for Ethernet connection
16. Equipment Grounding connection (metal chassis Ground) } Cylindrical hole with Set Screw (i) Hole Diameter: 5/16",
17. NEMA5-20R, Duplex AC Outlet } (ii) Set Screw: 5/16" X 24TPI; 3/8" Length; Slotted Head
18. 120 VAC Male Power Inlet Connector: IEC 60320, C14.
- NOTE:** AC Power Cord with mating Female IEC 60320, C13 connector on one end and NEMA5-15P Plug on the other end has been provided with the unit for 120VAC input connection
19. AC Input Breaker: 120 VAC, 15A
20. Ventilation slots for air discharge for 3 cooling fans [8(b)] located in the front
21. Handles

SECTION 7 | General Information on Lead Acid Batteries

7.1 GENERAL



INFO

For complete background information on Lead Acid Batteries and charging process, please visit www.samlexamerica.com > support > white papers > White Paper - Batteries, Chargers and Alternators.

Lead-acid batteries can be categorized by the type of application:

1. Automotive service - Starting/Lighting/Ignition (SLI, a.k.a. cranking), and Deep cycle service.
2. Deep Cycle Lead Acid Batteries of appropriate capacity are recommended for powering of inverters.

7.2 DEEP CYCLE LEAD ACID BATTERIES

Deep cycle batteries are designed with thick-plate electrodes to serve as primary power sources, to have a constant discharge rate, to have the capability to be deeply discharged up to 80 % capacity and to repeatedly accept recharging. They are marketed for use in recreation vehicles (RV), boats and electric golf carts – so they may be referred to as RV batteries, marine batteries or golf cart batteries. Use Deep Cycle batteries for powering these inverters.

7.3 RATED CAPACITY SPECIFIED IN AMPERE-HOUR (Ah)

Battery capacity "C" is specified in Ampere-hours (Ah). An Ampere is the unit of measurement for electrical current and is defined as a Coulomb of charge passing through an electrical conductor in one second. The Capacity "C" in Ah relates to the ability of the battery to provide a constant specified value of discharge current (also called "C-Rate": See Section 7.6) over a specified time in hours before the battery reaches a specified discharged terminal voltage (Also called "End Point Voltage") at a specified temperature of the electrolyte. As a benchmark, the automotive battery industry rates batteries at a discharge current or C-Rate of C/20 Amperes corresponding to 20 Hour discharge period. The rated capacity "C" in Ah in this case will be the number of Amperes of current the battery can deliver for 20 Hours at 80°F (26.7°C) till the voltage drops to 1.75V / Cell i.e. 21V for 24V battery and 42V for a 48V battery. For example, a 100 Ah battery will deliver 5A for 20 Hours.

7.4 RATED CAPACITY SPECIFIED IN RESERVE CAPACITY (RC)

Battery capacity may also be expressed as Reserve Capacity (RC) in minutes typically for automotive SLI (Starting, Lighting and Ignition) batteries. It is the time in minutes a vehicle can be driven after the charging system fails. This is roughly equivalent to the conditions after the alternator fails while the vehicle is being driven at night with the headlights on. The battery alone must supply current to the headlights and the computer/ignition system. The assumed battery load is a constant discharge current of 25A.

Reserve capacity is the time in minutes for which the battery can deliver 25 Amperes at 80°F (26.7°C) till the voltage drops to 1.75V / Cell i.e. 10.5V for 12V battery, 21V for 24V battery and 42V for 48V battery.

Approximate relationship between the two units is:

$$\text{Capacity "C" in Ah} = \text{Reserve Capacity in RC minutes} \times 0.6$$

SECTION 7 | General Information on Lead Acid Batteries

7.5 TYPICAL BATTERY SIZES

The Table 7.1 below shows details of some popular battery sizes:

BCI* Group	Battery Voltage, V	Battery Capacity, Ah
27 / 31	12	105
4D	12	160
8D	12	225
GC2**	6	220

* Battery Council International; ** Golf Cart

7.6 SPECIFYING CHARGING / DISCHARGING CURRENTS: C-RATE

Electrical energy is stored in a cell / battery in the form of DC power. The value of the stored energy is related to the amount of the active materials pasted on the battery plates, the surface area of the plates and the amount of electrolyte covering the plates. As explained above, the amount of stored electrical energy is also called the Capacity of the battery and is designated by the symbol "C".

The time in Hours over which the battery is discharged to the "End Point Voltage" for purposes of specifying Ah capacity depends upon the type of application. Let us denote this discharge time in hours by "T". Let us denote the discharge current of the battery as the "C-Rate". If the battery delivers a very high discharge current, the battery will be discharged to the "End Point Voltage" in a shorter period of time. On the other hand, if the battery delivers a lower discharge current, the battery will be discharged to the "End Point Voltage" after a longer period of time. Mathematically:

EQUATION 1: Discharge current "C-Rate" = Capacity "C" in Ah ÷ Discharge Time "T"

Table 7.2 below gives some examples of C-Rate specifications and applications:

Hours of discharge time "T" till the "End Point Voltage"	"C-Rate" Discharge Current in Amps = Capacity "C" in Ah ÷ Discharge Time "T" in Hrs.	Example of C-Rate Discharge Currents for 100 Ah battery
0.5 Hrs.	2C	200A
1 Hrs.	1C	100A
5 Hrs. (Inverter application)	C/5 or 0.2C	20A
8 Hrs. (UPS application)	C/8 or 0.125C	12.5A
10 Hrs. (Telecom application)	C/10 or 0.1C	10A
20 Hrs. (Automotive application)	C/20 or 0.05C	5A
100 Hrs.	C/100 or 0.01C	1A

NOTE: When a battery is discharged over a shorter time, its specified "C-Rate" discharge current will be higher. For example, the "C-Rate" discharge current at 5 Hour discharge period i.e. C/5 Amps will be 4 times higher than the "C-Rate" discharge current at 20 Hour discharge period i.e. C/20 Amps.

SECTION 7 | General Information on Lead Acid Batteries

7.7 CHARGING / DISCHARGING CURVES

Fig. 7.1 shows the charging and discharging characteristics of a typical 12V / 24V / 48V Lead Acid battery at electrolyte temperature of 80°F / 26.7°C. The curves show the % State of Charge (X-axis) versus terminal voltage (Y-axis) during charging and discharging at different C-Rates. **Please note that X-axis shows % State of Charge. State of Discharge will be = 100% - % State of Charge.** These curves will be referred to in the subsequent explanations.

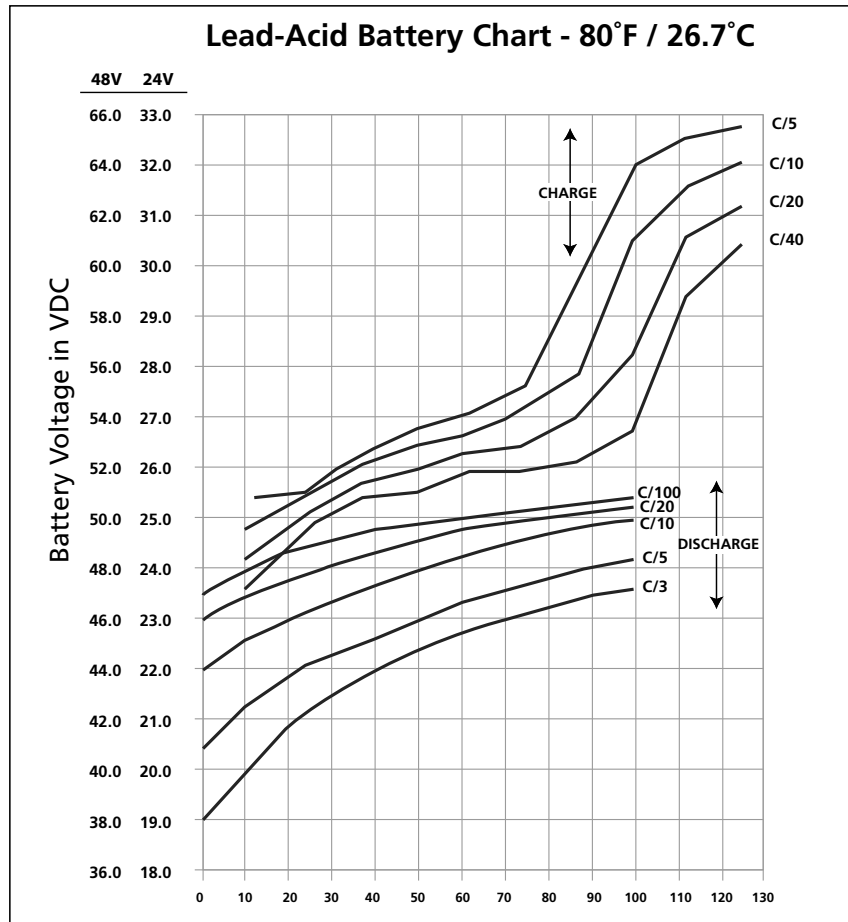

Fig. 7.1: Charging / Discharging Curves for 24V / 48V Lead Acid Batteries

7.8 REDUCTION IN USABLE CAPACITY AT HIGHER DISCHARGE RATES – TYPICAL IN INVERTER APPLICATION

As stated above, the rated capacity of the battery in Ah is normally applicable at a discharge rate of 20 Hours. As the discharge rate is increased as in cases where the inverters are driving higher capacity loads, the usable capacity reduces due to "Peukert Effect". This relationship is not linear but is more or less according to the Table 7.3.

SECTION 7 | General Information on Lead Acid Batteries

C-Rate Discharge Current	Usable Capacity (%)
C/20	100%
C/10	87%
C/8	83%
C/6	75%
C/5	70%
C/3	60%
C/2	50%
1C	40%

Table 7.3 shows that a 100 Ah capacity battery will deliver 100% (i.e. full 100 Ah) capacity if it is slowly discharged over 20 Hours at the rate of 5 Amperes (50W output for a 12V inverter and 100W output for a 24V inverter). However, if it is discharged at a rate of 50 Amperes (500W output for a 12V inverter and 1000W output for a 24V inverter) then theoretically, it should provide $100 \text{ Ah} \div 50 = 2$ Hours. However, Table 7.3 shows that for 2 Hours discharge rate, the capacity is reduced to 50% i.e. 50 Ah. Therefore, at 50 Ampere discharge rate (500W output for a 12V inverter and 1000W output for a 24V inverter) the battery will actually last for $50 \text{ Ah} \div 50 \text{ Amperes} = 1$ Hour.

7.9 STATE OF CHARGE (SOC) OF A BATTERY – BASED ON “STANDING VOLTAGE”

The “Standing Voltage” of a battery under open circuit conditions (no load connected to it) can approximately indicate the State of Charge (SOC) of the battery. The “Standing Voltage” is measured after disconnecting any charging device(s) and the battery load(s) and letting the battery “stand” idle for 3 to 8 hours before the voltage measurement is taken. Table 7.4 shows the State of Charge versus Standing Voltage for a typical 12V / 24V / 48V battery system at 80°F (26.7°C).

Percentage of Full Charge	Standing Voltage of Individual Cells	Standing Voltage of 24V Battery	Standing Voltage of 48V Battery
100%	2.105V	25.26V	50.52V
90%	2.10V	25.20V	50.40V
80%	2.08V	25.00V	50.00V
70%	2.05V	24.60V	49.20V
60%	2.03V	24.40V	48.80V
50%	2.02V	24.20V	48.40V
30%	1.97V	23.60V	47.20V
20%	1.95V	23.40V	46.80V
10%	1.93V	23.20V	46.40V
0%	= / < 1.93V	= / < 23.20V	= / < 46.40V

Check the individual cell voltages / specific gravity. If the inter cell voltage difference is more than a 0.2V, or the specific gravity difference is 0.015 or more, the cells will require equalization. **Please note that only the non-sealed / vented / flooded / wet cell batteries are equalized. Do not equalize sealed / VRLA type of AGM or Gel Cell Batteries.**

SECTION 7 | General Information on Lead Acid Batteries

7.10 STATE OF DISCHARGE OF A LOADED BATTERY – LOW BATTERY / DC INPUT VOLTAGE ALARM AND SHUTDOWN IN INVERTERS

Most inverter hardware estimate the State of Discharge of the loaded battery by measuring the voltage at the inverter's DC input terminals (considering that the DC input cables are thick enough to allow a negligible voltage drop between the battery and the inverter).

The State of Discharge of a battery is estimated based on the measured terminal voltage of the battery. The terminal voltage of the battery is dependent upon the following:

- **Temperature of the battery electrolyte:** Temperature of the electrolyte affects the electrochemical reactions inside the battery and produces a Negative Voltage Coefficient – during charging / discharging, the terminal voltage drops with rise in temperature and rises with drop in temperature.
- **The amount of discharging current or "C-Rate":** A battery has non linear internal resistance and hence, as the discharge current increases, the battery terminal voltage decreases non-linearly.

The discharge curves in Fig. 7.1 show the % State of Charge versus the terminal voltage of typical battery under different charge /discharge currents, i.e. "C-Rates" and fixed temperature of 80°F.

NOTE: The X-axis of Curves shown in Fig 7.1 indicates the % State of Charge. % State of charge may be converted to % State of Discharge using formula given below:

$$\% \text{ State of Discharge} = 100\% - \% \text{ State of Charge}$$

7.11 LOW DC INPUT VOLTAGE ALARM IN INVERTERS

Inverters are provided with audible alarm that is normally triggered when the voltage at the DC input terminals of the inverter has dropped to 80% discharged condition at C-Rate discharge current of C/5 Amps. Please note that the terminal voltage relative to a particular of State Discharge decreases with rise in the value of the discharge current. For example, terminal voltages for State of Discharge of 80% (State of Charge of 20%) for various discharge currents will be as given at Table 7.5 (Refer to Fig 7.1 for parameters and values shown in Table 7.5):

Discharge Current: C-Rate	Terminal Voltage at 80% State of Discharge (20% SOC)		Terminal Voltage When Completely Discharged (0% SOC)	
	24V	48V	24V	48V
C/3 A	20.8V	41.6V	19.0V	38.0V
C/5 A	21.8V	43.6V	20.4V	40.8V
C/10 A	23.0V	46.0V	22.0V	44.0V
C/20 A	23.8V	47.6V	23.0V	46.0V
C/100 A	24.2V	48.4V	23.4V	46.8V

The threshold of Low DC Input Voltage Alarm is programmable in this Inverter through parameter "UV Alarm" (UV stands for "Under Voltage). Default "UV Alarm" is 21.5V for PSR-1200-24 and 43.0V for PSR-1200-48. For programming details, refer to Fig 10.1 / Table 10.1 under Main Menu for Parameter Group 2 – "Input Setup" / Sub Menu for Parameter Group 2, Parameter (f) – "UV Alarm" (Section 10.2.2.6).

SECTION 7 | General Information on Lead Acid Batteries

7.12 LOW DC INPUT VOLTAGE SHUTDOWN IN INVERTERS

7.12.1 General

As explained earlier at Section 7.11, at around 80% State of Discharge of the battery at C-Rate discharge current of around C/5 Amps, the Low DC Input Voltage Alarm is sounded to warn the user to disconnect the battery to prevent further draining of the battery. If the load is not disconnected at this stage, the batteries will be drained further to a lower voltage corresponding to 100% discharged condition that is harmful for the battery and for the inverter. The inverter is, therefore, shut down when the DC input voltage reaches the threshold of 100% discharged condition.

This is done to protect the inverter against higher DC input currents at lower than normal DC input voltages. Higher than normal DC input currents produce over heating in the input section of the inverter and reduce reliability of components.

As explained above, inverters are normally provided with a protection to shut down the output of the inverter if the DC voltage at the input terminals of the inverter drops below a threshold of corresponding to 100% discharged condition. In this inverter, this threshold is programmable through parameter "UVP Setting" (See Section 7.12.2). Referring to the Discharge Curves given in Fig 7.1, the State of 100% Discharge for various C-Rate discharge is as follows:

- 19.0V at very high C-rate discharge current of C/3 Amps.
- 20.5V at high C-Rate discharge current of C/5 Amps.
- 22.0V at lower C-rate Discharge current of C/10 Amps.

It is seen from the above that the terminal voltage at 100% discharged condition varies with the C-rate discharge current.

7.12.2 Programming of Parameter "UVP Setting"

In this inverter, the threshold of Low DC Input Voltage Shutdown is programmable and is called "UVP Setting" (UVP stands for Under Voltage Protection). The default value is 20V for PSR-1200-24 and 40V for PSR-1200-48. This default value is close to the terminal voltage at 100% discharge condition at C-rate discharge current of C/5 Amperes (Refer to Fig 7.1). For programming details, refer to Fig 10.1 / Table 10.1 under Main Menu for Parameter Group 2 – "Input Setup" / Sub Menu for Parameter Group 2, Item (c) "UVP Setting" (Section 10.2.2.3).

7.13 DEPTH OF DISCHARGE OF BATTERY AND BATTERY LIFE

7.13.1 General

The more deeply a battery is discharged on each cycle, the shorter the battery life. Using more batteries than the minimum required will result in longer life for the battery bank. A typical cycle life chart is given in the Table 7.6:

Depth of Discharge % of Ah Capacity	Cycle Life of Group 27 /31	Cycle Life of Group 8D	Cycle Life of Group GC2
10	1000	1500	3800
50	320	480	1100
80	200	300	675
100	150	225	550

SECTION 7 | General Information on Lead Acid Batteries

17.3.2 Shutting Down the Inverter at Desired Depth of Discharge

It is recommended that programmable parameter "UVP Setting (See Section 7.12.2) may be used to shut down the inverter at voltage threshold corresponding to the desired Depth of Discharge. For example, if the inverter is to be shut down at 80% Depth of Discharged (20% State of Charge) at C-Rate discharge current of C/5 Amps, the voltage will be 21.8V for PSR-1200-24 (Refer to Fig 7.1).

7.14 SERIES AND PARALLEL CONNECTION OF BATTERIES

7.114.1 Series Connection

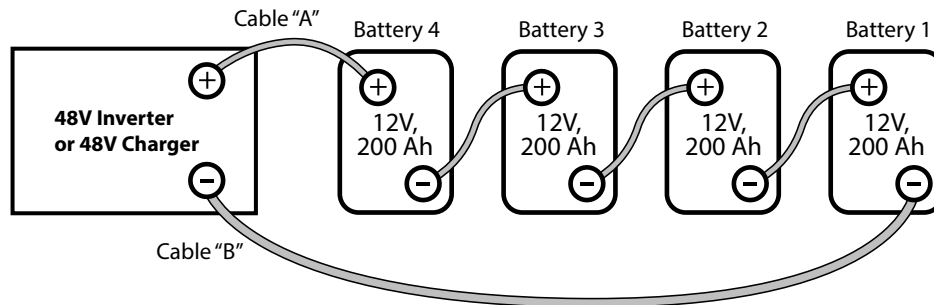
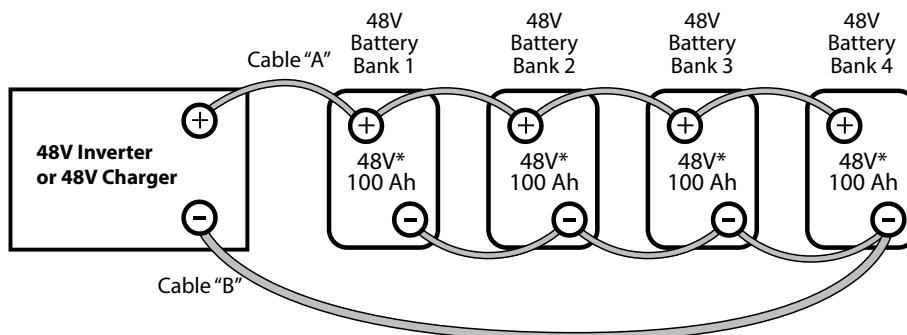

Fig 7.2: Series Connection

When two or more batteries are connected in series, their voltages add up but their Ah capacity remains the same. Fig. 7.2 shows 4 pieces of 12V, 200 Ah batteries connected in series to form a battery bank of 48V with a capacity of 200 Ah. The Positive terminal of Battery 4 becomes the Positive terminal of the 48V bank. The Negative terminal of Battery 4 is connected to the Positive terminal of Battery 3. The Negative terminal of Battery 3 is connected to the Positive terminal of Battery 2. The Negative terminal of Battery 2 is connected to the Positive terminal of Battery 1. The Negative terminal of Battery 1 becomes the Negative terminal of the 48V battery bank.

7.14.2 Parallel Connection



* **NOTE:** Each of the 48V, 100 Ah battery banks will consist of (i) 8 pieces of 6V, 100 Ah batteries in series or (ii) 4 pieces of 12V, 100 Ah batteries in series.

Fig 7.3: Parallel Connection

SECTION 7 | General Information on Lead Acid Batteries

When two or more batteries are connected in parallel, their voltage remains the same but their Ah capacities add up. Fig. 7.3 shows 4 pieces of 48V, 100 Ah Battery Banks connected in parallel to form a battery bank of 48V with a capacity of 400 Ah. The four Positive terminals of Battery Banks 1 to 4 are paralleled (connected together) and this common Positive connection becomes the Positive terminal of the 48V bank. Similarly, the four Negative terminals of Battery Banks 1 to 4 are paralleled (connected together) and this common Negative connection becomes the Negative terminal of the 48V battery bank.

7.14.3 Series – Parallel Connection

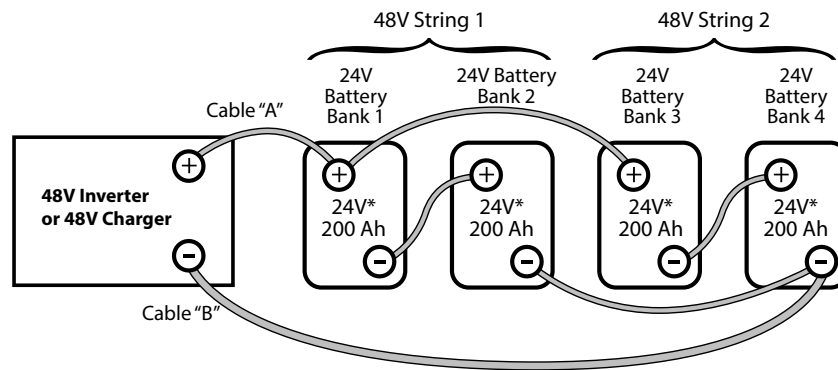

* NOTE: Each of the 24V, 200 Ah Battery Banks may be (i) 2x 12V, 200 Ah batteries in series, or (ii) 4x 6V, 200 Ah batteries in series

Fig. 7.4: Series-Parallel Connection

Figure 7.4 shows a series – parallel connection consisting of four 24V, 200 Ah Battery Banks to form a 48V, 400 Ah battery bank. Two 24V, 200 Ah Battery Banks 1 and 2 are connected in series to form a 48V, 200 Ah Battery Bank (String 1). Similarly, two 24V, 200 Ah Battery Banks 3 and 4 are connected in series to form a 48V, 200 Ah Battery Bank (String 2). These two 48V, 200 Ah Strings 1 and 2 are connected in parallel to form a 48V, 400 Ah bank.



CAUTION!

When 2 or more batteries / battery strings are connected in parallel and are then connected to an inverter or charger (See Figs 7.3 and 7.4), attention should be paid to the manner in which the charger / inverter is connected to the battery bank. Please ensure that if the Positive output cable of the battery charger / inverter (Cable "A") is connected to the Positive battery post of the first battery bank (Battery Bank 1 in Fig 7.3) or to the Positive battery post of the first battery string (Battery Bank 1 of String 1 in Fig. 7.4), then the Negative output cable of the battery charger / inverter (Cable "B") should be connected to the Negative battery post of the last battery bank (Battery Bank 4 as in Fig. 7.3) or to the Negative Post of the last battery string (Battery Bank 4 of Battery String 2 as in Fig. 7.4). This connection ensures the following:

- The resistances of the interconnecting cables will be balanced.
- All the individual batteries / battery strings will see the same series resistance.
- All the individual batteries will charge / discharge at the same charging current and thus, will be charged to the same state at the same time.
- None of the batteries will see an overcharge condition.

SECTION 7 | General Information on Lead Acid Batteries

7.15 SIZING THE INVERTER BATTERY BANK

One of the most frequently asked questions is, "how long will the batteries last?" This question cannot be answered without knowing the size of the battery system and the load on the inverter. Usually this question is turned around to ask "How long do you want your load to run?", and then specific calculation can be done to determine the proper battery bank size.

There are a few basic formulae and estimation rules that are used:

1. Active Power in Watts (W) = Voltage in Volts (V) x Current in Amperes (A) x Power Factor.
2. For example, for an inverter running from a 48V battery system, the approximate DC current required from the 48V batteries is the AC power delivered by the inverter to the load in Watts (W) divided by 40.
3. Energy required from the battery = DC current to be delivered (A) x Time in Hours (h).

The first step is to estimate the total AC Watts (W) of load(s) and for how long the load(s) will operate in hours (h). The AC Watts are normally indicated in the electrical nameplate for each appliance or equipment. In case AC Watts (W) are not indicated, Formula 1 given above may be used to calculate the AC Watts. The next step is to estimate the DC current in Amperes (A) from the AC Watts as per Formula 2 above. An example of this calculation for a 48V inverter is given below:

Let us say that the total AC Watts delivered by a 48 VDC input inverter = 1000W.

Then, using Formula 2 above, the approximate DC current to be delivered by the 48V batteries = $1000W \div 40 = 25$ Amperes.

Next, the energy required by the load in Ampere Hours (Ah) is determined.

For example, if the load is to operate for 3 hours then as per Formula 3 above, the energy to be delivered by the 48V batteries = $25 \text{ Amperes} \times 3 \text{ Hours} = 75 \text{ Ampere Hours (Ah)}$.

Now, the capacity of the batteries is determined based on the run time and the usable capacity.

From Table 7.3 "Battery Capacity versus Rate of Discharge", the usable capacity at 3 Hour discharge rate is 60%. Hence, the actual capacity of the 48V batteries to deliver 75 Ah will be equal to: $75 \text{ Ah} \div 0.6 = 125 \text{ Ah}$.

And finally, the actual desired rated capacity of the batteries is determined based on the fact that normally only 80% of the capacity will be available with respect to the rated capacity due to non availability of ideal and optimum operating and charging conditions. So the final requirements will be equal to:

$125 \text{ Ah} \div 0.8 = 156.25 \text{ Ah}$ (note that the actual energy required by the load was 75 Ah).

It will be seen from the above that the final rated capacity of the batteries is almost 2 times the energy required by the load in Ah. **Thus, as a Rule of Thumb, the Ah capacity of the batteries should be twice the energy required by the load in Ah.**

7.16 CHARGING BATTERIES

Batteries can be charged by using good quality AC powered battery charger or from alternative energy sources like solar panels, wind or hydro systems. Make sure an appropriate Battery Charge Controller is used. It is recommended that batteries may be charged at 10% to 13% of their Ah capacity (Ah capacity based on

SECTION 7 | General Information on Lead Acid Batteries

C-Rate of 20 Hr Discharge Time). Also, for complete charging (return of 100% capacity) of Sealed Lead Acid Battery, it is recommended that a 3 Stage Charger may be used (Constant Current Bulk Charging Stage ▶ Constant Voltage Boost / Absorption Charging ▶ Constant Voltage Float Charging).

In case, Wet Cell / Flooded Batteries are being used, a 4-stage charger is recommended (Constant Current Bulk Charging Stage ▶ Constant Voltage Boost / Absorption Stage ▶ Constant Voltage Equalization Stage ▶ Constant Voltage Float Stage).

SECTION 8 | Installation



WARNING!

1. Before commencing installation, please read the safety instructions explained in Section 1 titled "Safety Instructions".
2. It is recommended that the installation should be undertaken by a qualified, licensed / certified electrician.
3. Various recommendations made in this manual on installation will be superseded by the National / Local Electrical Codes related to the location of the unit and the specific application.

8.0 INSTALLATION ACCESSORIES SUPPLIED WITH THE UNIT

Following accessories have been provided with the unit:

- a) AC Power Cord for AC input
- b) Pin Type Lugs for DC input wiring
 - PSR-1200-24 PTNB 35-20 2 pieces
 - PSR-1200-48 PTNB 10-12 2 pieces
- c) Spare set screws for DC Input Terminals 2 pieces

8.1 LOCATION OF INSTALLATION

Please ensure that the following requirements are met:

Working Environment: Indoor use.

Cool: Heat is the worst enemy of electronic equipment. Hence, please ensure that the unit is installed in a cool area that is also protected against heating effects of direct exposure to the sun or to the heat generated by other adjacent heat generating devices.

Well Ventilated: The unit is cooled / ventilated by 3 temperature / load controlled fans [8(b), Fig 6.1]. To avoid shut down of the inverter due to over temperature, do not cover or block suction / exhaust openings [8(a) and 20, Figs 6.1 / 6.2] or install the unit in an area with limited airflow. Keep a minimum clearance of 10"

SECTION 8 | Installation

around the unit to provide adequate ventilation. If installed in an enclosure, openings must be provided in the enclosure, directly opposite to the air-suction and air-exhaust openings of the inverter.

Dry: There should be no risk of condensation, water or any other liquid that can enter or fall on the unit.

Clean: The area should be free of dust and fumes. Ensure that there are no insects or rodents. They may enter the unit and block the ventilation openings or short circuit electrical circuits inside the unit.

Protection Against Fire Hazard: The unit is not ignition protected and should not be located under any circumstance in an area that contains highly flammable liquids like gasoline or propane as in an engine compartment with gasoline-fueled engines. Do not keep any flammable / combustible material (i.e., paper, cloth, plastic, etc.) near the unit that may be ignited by heat, sparks or flames.

Closeness to the Battery Bank: Locate the unit as close to the battery bank as possible to prevent excessive voltage drop in the battery cables and consequent power loss and reduced efficiency. However, the unit should not be installed in the same compartment as the batteries (flooded or wet cell) or mounted where it will be exposed to corrosive acid fumes and flammable Oxygen and Hydrogen gases produced when the batteries are charged. The corrosive fumes will corrode and damage the unit and if the gases are not ventilated and allowed to collect, they could ignite and cause an explosion.

Accessibility: Do not block access to the front panel. Also, allow enough room to access the AC receptacles and DC wiring terminals and connections, as they will need to be checked and tightened periodically.

Preventing Radio Frequency Interference (RFI): The unit uses high power switching circuits that generate RFI. This RFI is limited to the required standards. Locate any electronic equipment susceptible to radio frequency and electromagnetic interference as far away from the inverter as possible. *Read Section 3, "Limiting Electromagnetic Interference (EMI)" for additional information.*

SECTION 8 | Installation

8.2. OVERALL DIMENSIONS

The overall dimensions and the location of the mounting slots for PSR-1200-24 and PSR-1200-48 are shown at Fig. 8.1.

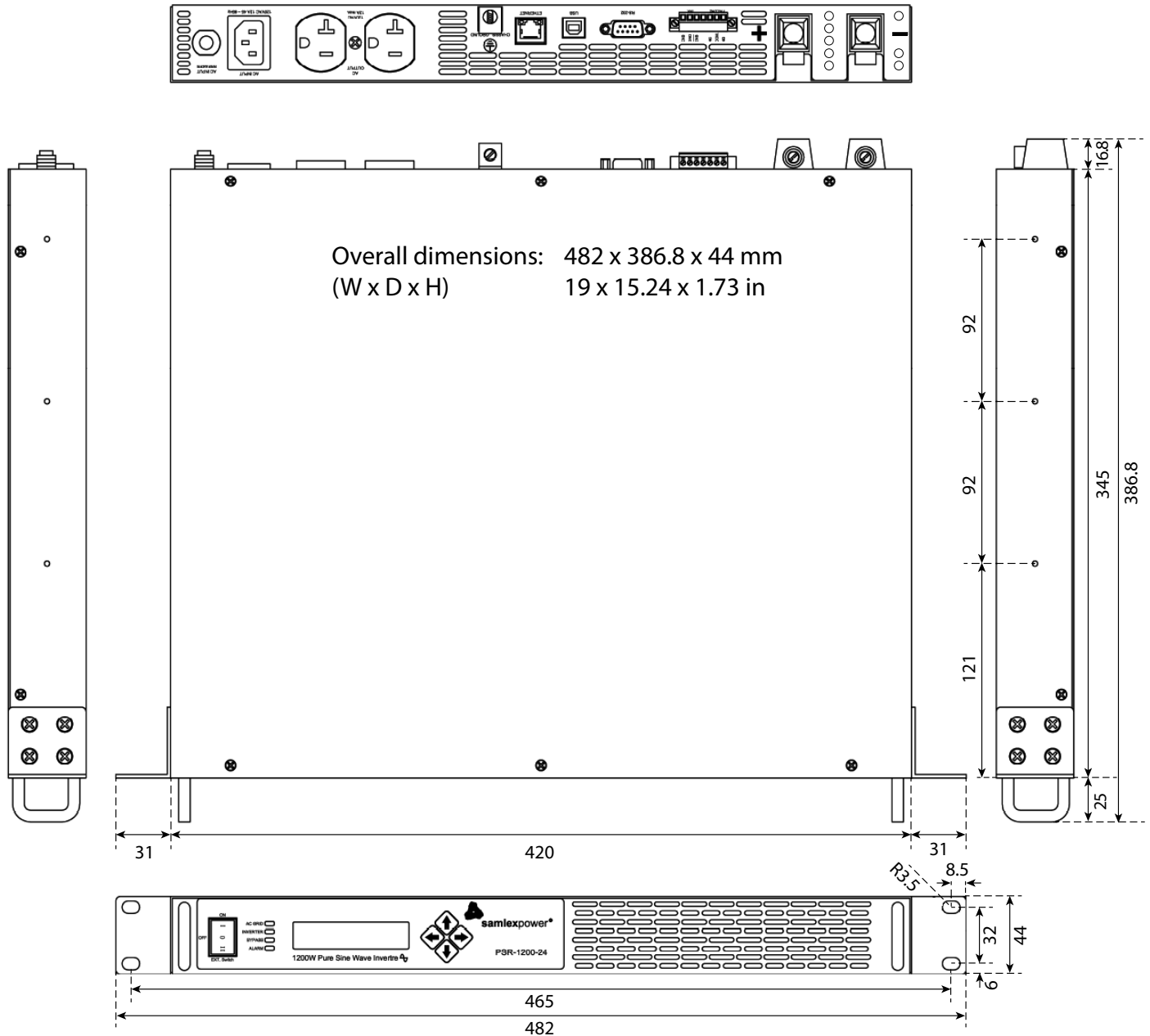

Fig. 8.1: PSR-1200-24 & PSR-1200-48 – Overall Dimensions & Mounting Arrangement

SECTION 8 | Installation

8.3 MOUNTING ORIENTATION

The unit has air intake and exhaust openings for the cooling fan [see 8(a) and 20 in Figs 6.1 and 6.2]. It has to be mounted in such a manner so that small objects should not be able to fall easily into the unit from these openings and cause electrical / mechanical damage. Also, the mounting orientation should be such that if the internal components overheat and melt / dislodge due to a catastrophic failure, the melted / hot dislodged portions should not be able to fall out of the unit on to a combustible material and cause a fire hazard. The size of openings has been limited as per the safety requirements to prevent the above possibilities when the unit is mounted in the recommended orientations. In order to meet the regulatory safety requirements, the mounting has to satisfy the following requirements:

- Mount on a non-combustible material.
- The mounting surface should be able to support the weight of the unit
- Mount horizontally on a horizontal surface - above a horizontal surface (e.g. table top or a shelf).
- Mount horizontally on a vertical surface – The unit can be mounted on a vertical surface (like a wall) with the fan axis horizontal (fan opening facing left or right).



WARNING!

Mounting the unit vertically on a vertical surface is NOT recommended (fan opening facing up or down). As explained above, this is to prevent falling of objects into the unit through the fan opening when the fan opening faces up. If fan opening faces down, hot damaged component may fall out.

The surface of the unit is likely to be at elevated temperature in conditions of higher load and higher ambient temperature. Hence, the unit should be installed in a manner where it is not likely to come in contact with any person.

8.4 DC SIDE CONNECTIONS

8.4.1 Preventing DC Input Over Voltage

It is to be ensured that the DC input voltage of this unit is up to 34 VDC for PSR-1200-24 and 60 VDC for PSR-1200-48 to prevent permanent damage to the unit. Please observe the following precautions:

- Ensure that the maximum charging voltage of the external battery charger / alternator / solar charge controller is up to 34 VDC for PSR-1200-24 and up to 60 VDC for PSR-1200-48.
- Do not use unregulated solar panels to charge the battery connected to this unit. Under open circuit conditions and in cold ambient temperatures, the output of the solar panel / array may reach higher than the limiting voltages specified above. Always use a charge controller between the solar panel and the battery.
- When using Diversion Charge Control Mode in a charge controller, the solar / wind / hydro source is directly connected to the battery bank. In this case, the controller will divert excess current to an external load. As the battery charges, the diversion duty cycle will increase. When the battery is fully charged, all the source energy will flow into the diversion load if there are no other loads. The charge controller will disconnect the diversion load if the current rating of the controller is exceeded. Disconnection of

SECTION 8 | Installation

the diversion load may damage the battery as well as the inverter or other DC loads connected to the battery due to high voltages generated during conditions of high winds (for wind generators), high water flow rates (for hydro generators). It is, therefore, to be ensured that the diversion load is sized correctly to prevent the above over voltage conditions.

- These units are designed to operate from Lead Acid Battery System with nominal voltage of 24 VDC for PSR-1200-24 and 48 VDC for PSR-1200-48. Do not operate these units from battery system voltage higher/lower than the above nominal voltages.

8.4.2 Preventing Reverse Polarity on the DC Input Side



CAUTION!

Damage caused by reverse polarity is not covered by warranty! When making battery connections on the input side, make sure that the polarity of battery connections is correct (Connect the Positive of the battery to the Positive terminal of the unit and the Negative of the battery to the Negative terminal of the unit). If the input is connected in reverse polarity, DC fuse(s) inside the inverter will blow and may also cause permanent damage to the inverter.

8.4.3 Connection from Batteries to the DC Input Side – Sizing of Cables and Fuses



CAUTION!

The input section of the inverter has large value capacitors connected across the input terminals. As soon as the DC input connection loop (Battery (+) terminal → External Fuse → Positive input terminal of the Inverter → Negative input terminal of the Inverter → Battery (-) terminal) is completed, these capacitors will start charging and the unit will **momentarily** draw very heavy current to charge these capacitors that will produce sparking on the last contact in the input loop even when the unit is in OFF condition. Ensure that the fuse is inserted only after all the connections in the loop have been completed so that sparking is limited to the fuse area.

Flow of electric current in a conductor is opposed by the resistance of the conductor. The resistance of the conductor is directly proportional to the length of the conductor and inversely proportional to its cross-section (thickness). The resistance in the conductor produces undesirable effects of voltage drop and heating. The size (thickness / cross-section) of the conductors is designated by AWG (American Wire Gauge). Conductors thicker than AWG #4/0 are sized in MCM/kcmil. Table 8.1 gives Resistance in Ohm (Ω) per Foot at 25°C / 77°F for the wire sizing recommended for use with this inverter.

WIRE SIZE, AWG	RESISTANCE IN OHM (Ω) PER FOOT AT 25°C / 77°F
AWG#8	0.0006405 Ω per Foot
AWG#3	0.0002009 Ω per Foot
AWG#2	0.0001593 Ω per Foot

SECTION 8 | Installation

Conductors are protected with insulating material rated for specific temperature e.g. 75°C/167°F. As current flow produces heat that affects insulation, there is a maximum permissible value of current (called "Ampacity") for each size of conductor based on temperature rating of its insulation. The insulating material of the cables will also be affected by the elevated operating temperature of the terminals to which these are connected. Ampacity of cables is based on the National Electrical Code (NEC)-2014. Please see details given under "Notes for Table 8.2".

The DC input circuit is required to handle very large DC currents and hence, the size of the cables and connectors should be selected to ensure minimum voltage drop between the battery and the inverter. Thinner cables and loose connections will result in poor inverter performance and will produce abnormal heating leading to risk of insulation melt down and fire. Normally, the thickness of the cable should be such that the voltage drop due to the current & the resistance of the length of the cable should be less than 2% to 5%. Use oil resistant, multi-stranded copper wire cables rated at 75°C / 167°F minimum. Do not use aluminum cable as it has higher resistance per unit length. Cables can be bought at a marine / welding supply store. Effects of low voltage on common electrical loads are given below:

- **Lighting circuits** - incandescent and Quartz Halogen: A 5% voltage drop causes an approximate 10% loss in light output. This is because the bulb not only receives less power, but the cooler filament drops from white-hot towards red-hot, emitting much less visible light.
- **Lighting circuits** - fluorescent: Voltage drop causes a nearly proportional drop in light output.
- **AC induction motors** - These are commonly found in power tools, appliances, well pumps etc. They exhibit very high surge demands when starting. Significant voltage drop in these circuits may cause failure to start and possible motor damage.
- **PV battery charging circuits** - These are critical because voltage drop can cause a disproportionate loss of charge current to charge a battery. A voltage drop greater than 5% can reduce charge current to the battery by a much greater percentage.

8.4.4 Fuse Protection in the Battery Circuit

A battery is an **unlimited** source of current. Under short circuit conditions, a battery can supply thousands of Amperes of current. If there is a short circuit along the length of the cables that connects the battery to the inverter, thousands of Amperes of current can flow from the battery to the point of shorting and that section of the cable will become red-hot, the insulation will melt and the cable will ultimately break. This interruption of very high current will generate a hazardous, high temperature, high-energy arc with accompanying high-pressure wave that may cause fire, damage nearby objects and cause injury. To prevent occurrence of hazardous conditions under short circuit conditions, the fuse used in the battery circuit should limit the current (should be "Current Limiting Type"), blow in a very short time (should be Fast Blow Type) and at the same time, quench the arc in a safe manner. For this purpose, **UL Class T Fuse** or equivalent should be used (As per UL Standard 248-15). This special purpose current limiting, very fast acting fuse will blow in less than 8 ms under short circuit conditions. **Appropriate capacity of the above Class T fuse or equivalent should be installed within 7" of the battery Plus (+) Terminal** (Please see Table 8.2 for fuse sizing). Marine Rated Battery Fuses, MRBF-xxx Series made by Cooper Bussmann may also be used. These fuses comply with ISO 8820-6 for road vehicles.

SECTION 8 | Installation



WARNING!

Use of an appropriately sized external fuse as described above is mandatory to provide safety against fire hazard due to accidental short circuit in the battery cables. Please note that the internal DC side fuses are designed to protect their internal components of the inverter against DC side overloading. These fuses will NOT blow if there is a short circuit along the length of wires connecting the battery and the inverter.

8.4.5 Recommended Sizes of Battery Cables and Fuses

Sizes of cables and fuses are shown in Table 8.2. Sizing is based on safety considerations specified in NEC-2014. Please refer to "Notes for Table 8.2" for details.

TABLE 8.2 RECOMMENDED SIZING OF BATTERY CABLES AND EXTERNAL BATTERY SIDE FUSE						
Model No. (1)	Rated DC Input Current (See Note 1) (2)	Minimum Ampacity of cable as per NEC (See Note 2) (3)	External Battery Fuse Size (Based in Column 2) (See Note 3) (4)	Minimum cable size (See Note 4)		
				3 ft / 0.91M (5)	6 ft / 1.83M (6)	10 ft / 3.05M (7)
PSR-1200-24	80A	100A	80A	AWG#3	AWG#3	AWG#2
PSR-1200-48	40A	50A	40A	AWG#8	AWG#8	AWG#8

NOTES FOR TABLE 8.2

- 1) Column 2 indicates the Rated DC Input Current drawn from the battery.
- 2) Column 3 indicates minimum NEC Ampacity for sizing of conductors. NEC Ampacity is not less than 125% of the rated DC input current (Column 2) - Refer to NEC-2014 (National Electrical Code) - Section 215.2(A) (1)(a) for Feeder Circuits.
- 3) Column (4) indicates the size of external fuse in the battery circuit. It is mandatory to install this fuse within 7" of the battery Positive terminal to protect the battery cables against short circuit. Amp rating of the fuse is based on the following considerations:
 - a) Not less than the Rated DC Input Current (Column 2)
 - b) Closest Standard Ampere Rating of Fuse has been used - Refer to NEC-2014 (National Electrical Code) - Section 240.6(A)
 - c) Where Standard Fuse Rating does not match the required Ampacity (Column 2), the next higher Standard Rating of the fuse may be used - Refer to NEC-2014 (National Electrical Code) - Section 240.4(B)
 - d) **Type of fuse:** Fast-acting, Current Limiting, UL Class T (UL Standard 248-15) or equivalent
- 4) Columns 5 to 7 indicate minimum cable conductor size that is based on the following 2 considerations. **Thicker conductor out of the following 2 considerations has been chosen:**
 - a) As per guidelines in NEC (2014) Table 310.15(B)(16) for allowable Ampacities of Insulated Conductors running in raceway/conduit. Conductor size is based on:
 - (i) NEC Ampacity specified at Column 3,
 - (ii) Copper conductor with temperature rating of 75°C/167°F and
 - (iii) Ambient temperature of 30°C / 86°F
 - b) Voltage drop across the length of cables limited to 2% of 24 VDC i.e. 0.48 VDC for PSR-1200-24 and 2% of 48Vi.e. 0.96V for PSR-1200-48

SECTION 8 | Installation

- i) Voltage drop has been calculated by multiplying the Rated DC Input Current (Column 2) and the resistance of the total length of Copper conductor (**the total length of conductor has been taken as 2 times the running distance between the unit and the battery to cover 2 lengths of Positive and Negative cable conductors**).
- ii) Resistance of the cable is based on Table 8.1.

5) Fuse in the battery circuit is primarily required for protection against short circuit in the battery cable run. The size of this fuse has to be equal to or larger than the Rated DC Input Current of the inverter at Column (2). Further, the Amp rating of the fuse used for protecting a battery cable against short circuit has to be lower than the Ampacity of the cable so that the fuse blows before the cable insulation is damaged due to overheating as a result of fault current higher than the Ampacity of the cable.

8.4.6 DC Input Terminals for Battery Connection

The DC input terminals for battery connection (10 & 11 in Fig. 6.2) have 7/6" diameter cylindrical hole with Set Screw (5/16" x 24 TPI ; 1/2" long ; Slotted Head).



CAUTION!

DO NOT insert the stranded bare end of the wire directly into the tubular hole as the set screw will not pinch all the strands, resulting in a partial/loose contact. Appropriate terminal lug should be crimped/soldered to the bare wire end.

To ensure firm contact, 2 pieces of pin type terminal lugs have been provided as follows:

- For PSR-1200-24: 2 Lugs Type PTNB 35-20 for wire size AWG #2 (35 mm²)
- For PSR-1200-48: 2 Lugs Type PTNB 10-12 for wire size AWG #8 (10 mm²)

8.4.7 Reducing RF Interference

Please comply with recommendations given in Section 3 – "Limiting Electromagnetic Interference".

8.5 AC SIDE CONNECTIONS



WARNING!

1. The AC output of the inverter cannot be synchronized with another AC source and hence, it is not suitable for paralleling. The AC output of the inverter should never be connected directly to an electrical breaker panel / load center which is also fed from the utility power/ generator. Such a connection will result in parallel operation and AC power from the utility / generator will be fed back into the inverter which will instantly damage the output section of the inverter and may also pose a fire and safety hazard. If an electrical breaker panel / load center is being fed from the utility power / generator and the inverter is required to feed this panel as backup power source, the AC power from the utility power/ generator and the inverter should first be fed to a manual selector switch / Automatic Transfer Switch and the output of the manual selector switch / Automatic Transfer Switch should be connected to the electrical breaker panel / load center.
2. To prevent possibility of paralleling and severe damage to the inverter, never use a simple jumper cable with a male plug on both ends to connect the AC output of the inverter to a handy wall receptacle in the home / RV.

SECTION 8 | Installation

8.5.1 AC Input and Output Connections

8.5.1.1 AC Inlet

AC input is fed through 120 VAC Male Power Inlet (IEC 60320 C14 Connector) (18, Fig 6.2).

AC Power cord with mating Female IEC 60320 C13 Connector on one end and NEMA5-15P Plug on the other end has been provided with the unit.

8.5.1.2 AC Outlets

AC output is provided through NEMA5-20R, Duplex AC outlets (17, Fig 6.2).

8.5.2 Bonding of AC Output Neutral to Equipment Ground (Metal Chassis Ground)

The Neutral slots of the NEMA5-20R Duplex Outlets (17, Fig 6.2) are bonded to the Equipment Ground (metal chassis Ground) of the inverter through Neutral to Ground Bond Switching Relay resulting in the following N-G bond conditions:

- Output Neutral and the metal chassis Ground are bonded when Inverter is supplying power to the load.
- Output Neutral and the metal chassis Ground are isolated when AC GRID is being bypassed.

See further details at Section 5.4.3.

8.6 GROUNDING TO EARTH OR TO OTHER DESIGNATED GROUND

For safety, ground the metal chassis of the inverter to the Earth Ground or to the other designated Ground. An equipment grounding Lug (16, Fig 6.2) has been provided for grounding the metal chassis of the inverter to the Earth Ground or to the other appropriate Ground.

When using the inverter in a building, connect a 10 mm² or AWG #8 insulated stranded copper wire from the above equipment grounding lug to the Earth Ground connection (a connection that connects to the Ground Rod or to the water pipe or to another connection that is solidly bonded to the Earth Ground). The connections must be tight against bare metal. Use star washers to penetrate paint and corrosion.

8.7 WIRED REMOTE ON / OFF CONTROL FOR INVERTER SECTION

4 methods are available to switch ON and switch OFF the Inverter Section using external, wired switching control. Please refer to Section 5.7 for details.

IMPORTANT NOTE: For activation of this wired remote ON / OFF control function, the 3-Position Rocher Switch (1, Fig 6.1) on the Front Panel has to be pressed down towards position marked "EXT. Switch".

8.8 2-WIRE REMOTE MONITORING OF ALARMS / FAULTS

Single Pole Double Throw (SPDT) relay contacts have been provided for remote signalling of 6 types of alarms / fault conditions. Refer to Section 5.8 for details.

SECTION 9 | Operation

9.1 SWITCHING ON AND SWITCHING OFF THE INVERTER SECTION

The Inverter Section of the unit can be switched ON and OFF as follows:

- Using 3-Position Rocker Switch (1, Fig 6.1) as follows:
 - Center position: OFF
 - Upper edge of the switch is pressed down towards marking “ON”: Inverter Section is switched ON
- Through Wired Remote On/Off Control:
 - Bottom edge of the switch is pressed down towards marking “EXT Switch”
 - The unit will then be switched ON and OFF through 1 of the 4 methods using Wired Remote ON / OFF Control (See Section 5.7 for details)



WARNING!

Refer to Fig 5.1.

If AC GRID input is being fed to the unit through AC Inlet (18, Fig 6.2) and has been switched ON, it will be bypassed to the AC outlets (17, Fig 6.2) even if the Inverter Section has been switched OFF either through the 3-Position Rocker Switch or through the Wired Remote On/Off Control. See explanation below:

As soon as AC GRID input is available, Relays RL-1 and RL-2 will get energized (even if the Inverter Section has been switched OFF either through the 3-Position Rocker Switch or through the Wired Remote On/Off Control). Normally Open (NO) contact pairs 1-2 and 3-4 will be closed. As the Inverter section is OFF / not supplying the load, the Normally Closed (NC) contacts of Relays RL-4 and RL-5 will bypass the AC GRID input voltage to the AC Outlets (17, Fig 6.2)

9.2 POWERING ON THE LOADS

After the Inverter is switched on, it takes a finite time for the inverter to be ready to deliver full power. Hence, always switch on the load(s) after a few seconds of switching on the Inverter. To prevent possibility of premature overload protection, avoid switching on the Inverter with the load already switched ON.

9.3 OPERATION OF COOLING FANS

The unit has 3 cooling fans located behind the air inlet slots in the front of the unit (8a, Fig 6.1). The fans draw cool air from the air inlet slots in the front of the unit and expel the hot air through the discharge vents in the back (20, Fig 6.2).

The fans are switched ON and OFF based on (i) the load current and (ii) temperature of 2 internal hot spots near 2 heat sinks (temperature of the 2 hot spots is sensed by Negative Temperature Coefficient (NTC) resistors NTC1 and NTC2). Fan control logic is as follows:

- Load Controlled Operation:
 - Switch ON fans when load is > 300W
 - Switch OFF fans when load is reduced to <280W
- Temperature controlled Operation:
 - Switch ON when any one of the 2 hot spots near the 2 heat sinks is $\geq 50^{\circ}\text{C}$
 - Switch OFF fans when both the 2 hot spots near the 2 heat sinks are $\leq 45^{\circ}\text{C}$

SECTION 9 | Operation

9.4 FRONT PANEL LEDS FOR MONITORING OF STATUS OF OPERATION

Table 9.0 provides information on 4 front panel LEDs (2,3,4,5 Fig 6.1) used for monitoring the operational status of the unit.

TABLE 9.0 LEDS FOR MONITORING OPERATING STATUS			
Name of Status LED	Status LED Color	Operating Status	
AC GRID	Green	CONDITION 1 Inverter Section is in OFF condition (LED marked "INVERTER" is Off) or DC Input is ≤ 16 VDC	CONDITION 2 Inverter Section is in ON condition (LED marked "INVERTER" is Green)
		Green LED under above Condition 1 indicates the following: <ul style="list-style-type: none"> AC GRID input voltage is available. Its frequency can be WITHIN OR OUTSIDE the "Synchronizable Frequency Window" 	Green LED under above Condition 2 indicates the following: <ul style="list-style-type: none"> AC GRID input voltage is available AC GRID input frequency is STRICTLY within the "Synchronizable Frequency Window"
	Orange	CONDITION 1 Inverter Section is in ON condition (LED marked "INVERTER" is Green)	
		Orange LED under above the Condition 1 indicates the following: <ul style="list-style-type: none"> Grid AC input is available and its frequency is NOT within the "Synchronizable Frequency Window" 	
OFF	When LED is off, it indicates the following: <ul style="list-style-type: none"> AC GRID input is NOT available 		
INVERTER	Green	CONDITION 1 LED marked "BYPASS" is off	CONDITION 2 LED marked "BYPASS" is Green
		Green LED under above Condition 1 indicates the following: <ul style="list-style-type: none"> Inverter output is being bypassed to the load 	Green LED under above Condition 2 indicates the following: <ul style="list-style-type: none"> Inverter is in standby condition (AC GRID input is being bypassed to the load)
	Red	Red LED indicates the following: <ul style="list-style-type: none"> Inverter is in Fault Mode 	
	OFF	When LED is off, it indicates the following: <ul style="list-style-type: none"> Inverter has been switched off 	
BYPASS	Green	CONDITION 1 <ul style="list-style-type: none"> Parameter "Transfer Type" could be either "Synchronized" (Default) or "Unsynchronized" Parameter "Inverter Mode" has been set up as "Off-line" (Default) LED marked AC GRID could be Green (AC GRID input is available and is within the "Synchronizable Frequency Window") or Orange (AC GRID input is available but is NOT within the "Synchronizable Frequency Window") LED marked INVERTER is off (Inverter Section is in OFF condition) 	CONDITION 2 <ul style="list-style-type: none"> Parameter "Transfer Type" has been set up as "Synchronized" (Default) Parameter "Inverter Mode" has been set up as "On-line" LED marked AC GRID is Green (AC GRID input is available and is within the "Synchronizable Frequency Window") LED marked INVERTER is Green (Inverter Section is in ON condition)
		When this LED is off under the above Condition 1, it indicates the following: <ul style="list-style-type: none"> Inverter is in OFF condition AC GRID input is available and is being bypassed to the load. 	When this LED is off under the above Condition 2, it indicates the following: <ul style="list-style-type: none"> AC GRID input is available and is being bypassed to the load.

SECTION 9 | Operation

TABLE 9.0 LEDS FOR MONITORING OPERATING STATUS (Continued)		
Name of Status LED	Status LED Color	Operating Status
BYPASS	OFF	<p>CONDITION 1</p> <ul style="list-style-type: none"> Parameter "Transfer Type" has been set up as "Synchronized" (Default) Parameter "Inverter Mode" has been set up as "On – Line" LED marked AC GRID is Green (AC GRID input is available and IS within the "Synchronizable Frequency Window") LED marked INVERTER is Green (Inverter Section is in ON condition)
		<p>CONDITION 2</p> <ul style="list-style-type: none"> Parameter "Transfer Type" has been set up as "Unsynchronized" Parameter "Inverter Mode" has been set up as "On-Line" LED marked AC GRID is Orange (AC GRID input is available but is NOT within the "Synchronizable Frequency Window") LED marked INVERTER is Green (Inverter Section is in ON condition)
		<p>When this LED is off under the above Condition 1, it indicates the following:</p> <ul style="list-style-type: none"> AC GRID input is NOT being bypassed as "On-Line" Mode has been selected Load is being powered by the Inverter
		<p>When this LED is off under the above Condition 2, it indicates the following:</p> <ul style="list-style-type: none"> AC GRID input is NOT being bypassed as "On-Line" Mode has been selected Load is being powered by the Inverter
ALARM	Orange	<p>Orange LED indicates activation of following protections leading to shut down of the Inverter Section:</p> <ul style="list-style-type: none"> Short Circuit Overload Over temperature Fan failure Over Voltage (OV) Protection Under Voltage (UV) Protection

9.5 LCD DISPLAY FOR MONITORING OF OPERATING PARAMETERS

LCD Display (6, Fig 6.1) is used for monitoring various operating parameters and also for setup of various programmable parameters and settings.

Refer to Startup Display and Dashboard portions of the Menu Map at Fig 10.1 (extract of these portions is given below at Fig 9.1 for ready reference. The "Startup Display" screens appear when the unit is switched ON (see Section 9.6 for details). The "Dashboard" shows the 5 scrollable screens that provide information on the operating parameters (see Sections 9.7 for details).

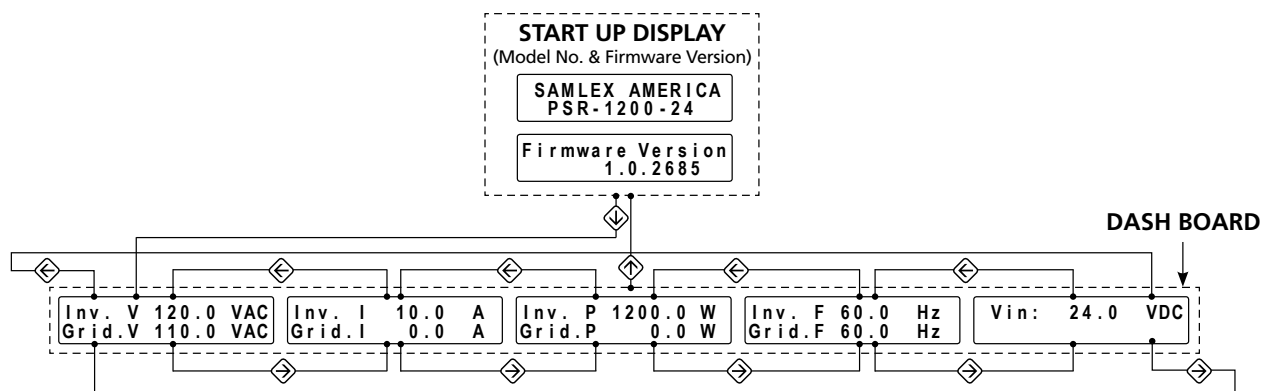



Fig 9.1: Startup Display and Dashboard (extract from Fig 10.1)

SECTION 9 | Operation

9.5.1 LCD Display: "LCD Auto-Off" and "LCD Contrast"

9.5.1.1 LCD Auto-Off: Programmable parameter "LCD Auto-Off" has been provided to either keep the LCD display on all the time or to switch off the display after expiry of programmable time period of 20 to 180 sec. For programming details, see Fig 10.1 / Table 10.1 under Main Menu for Parameter Group 1 – "UI Settings" / Sub Menu for Parameter Group 1, Parameter (a) – "LCD Contrast" (Section 10.2.1.1). In the default condition, the LCD Auto-Off function has been disabled and hence, the LCD screen will remain in on condition all the time.

When the LCD Display is in Auto-Off condition, it can be switched back to the Startup Display Screen by pressing the Down Key 

- To switch off the LCD Screen before the expiry of the "LCD Auto-Off" time period, press the Up Key 

9.5.1.2 LCD Contrast: This parameter can be programmed to control the LCD contrast. Programmable range is 0% to 100%. Default is 50%. For programming details, see Fig 10.1 / Table 10.1 under Main Menu for Parameter Group 1 – "UI Setting" / Sub Menu for Parameter Group 1, Parameter (b) – "Auto-off" (Section 10.2.1.2).

9.5.1.3 Various LCD Screens are available under Startup display and Dash Board for real time visual monitoring of important operating parameters. Refer to the Startup Display and Dash Board portions of the Menu Map at Fig 10.1. Details of LCD display of the operating parameters are explained in the succeeding Sections.

9.6 STARTUP DISPLAY

Refer to Startup Display portion of the screens at Fig 9.1 (extracted from Fig 10.1).

When the unit is switched ON, one loop of Startup Display will be seen. One loop of display consists of 2 screens as described in Table 9.1 below.

After the 2 Screens of Startup Display are shown (Table 9.1), the display will change to Dashboard: Screen1 (See Screen 1 in Table 9.2).

TABLE 9.1 STARTUP DISPLAY SCREENS	
<p>Startup Display: Screen 1</p> <div style="border: 1px solid black; padding: 5px; width: fit-content; margin: 10px auto;"> <p>SAMLEX AMERICA PSR-1200-24</p> </div>	<p>Screen 1 will show "SAMLEX AMERICA" as scrolling text in the first line followed by the Model No. of the unit i.e. "PSR-1200-24" or "PSR-1200-48" as scrolling text in the 2nd line.</p> <p>After a few seconds, Screen 1 will change to Screen 2 to show the Firmware Version. In Screen 2, both the lines will be displayed at the same time. After a few seconds, the 1st line text "Firmware Version" will blink 5 times @ 1 blink per sec.</p> <p><u>Next, the display will change to Dashboard: Screen 1 (See Screen 1 in Table 9.2)</u></p>
<p>Startup Display: Screen 2</p> <div style="border: 1px solid black; padding: 5px; width: fit-content; margin: 10px auto;"> <p>Firmware Version 1.0.2685</p> </div>	

SECTION 9 | Operation

9.7 DASHBOARD – GROUP OF 5 SCROLLABLE SCREENS DISPLAYING OPERATING PARAMETERS

Refer to the Dash Board portion of the screens at Fig 9.1 (extracted from Fig 10.1).

The Dash Board consists of group of 5 scrollable screens that display the operating parameters as described below.

Press the Down Key  from any of the 2 Startup Display Screens (Table 9.1) to go to the Dash Board.
Press the Up Key  from any of the Dash Board Screens (Table 9.2) to go to the Startup Display Screen.

NOTES:

























- The 5 Screens in the Dash Board described below are displayed in a continuous loop. Higher Screen Nos. are accessed by pressing the Right Key  and lower Screen Nos. are accessed by pressing the Left Key .
- When the unit is switched ON, Startup Display Screens will be shown as described in Table 9.1. If the Dash Board is entered now from the Startup Display Screen by pressing the Down Key , Screen 1 of the Dash Board will be displayed. If the display is changed to the Startup Display by pressing the Up Key  and back to the Dashboard by pressing the Down Key , the Dashboard will NOT display Screen 1 but will display the Screen that was being shown EARLIER.

TABLE 9.2 DASHBOARD SCREENS

<p style="text-align: center;">Dash Board: Screen 1</p> <div style="border: 1px solid black; padding: 5px; margin: 10px auto; width: fit-content;"> <p style="margin: 0;">Inv. V 120.0 VAC</p> <p style="margin: 0;">Grid. V 110.0 VAC</p> </div> <p>Press the Right Key  to change to Screen 2</p> <p>Press the Left Key  to change to Screen 5</p>	<p style="text-align: center;">Dash Board: Screen 1 for AC Voltage</p> <p>Screen 1 displays the Inverter Voltage (Inv. V) and the Grid Voltage (Grid V)</p> <ul style="list-style-type: none"> Pressing the Right Key  will change the display to Screen 2 for AC Current Pressing the Left Key  will change the display to Screen 5 for DC input voltage <p>NOTE: In Inverter Mode, the output voltage will be equal to the Inverter Voltage (Inv. V). In Pass-through Mode, the output voltage will be equal to Grid Voltage (Grid V).</p>
<p style="text-align: center;">Dash Board: Screen 2</p> <div style="border: 1px solid black; padding: 5px; margin: 10px auto; width: fit-content;"> <p style="margin: 0;">Inv. I 10.0 A</p> <p style="margin: 0;">Grid. I 0.0 A</p> </div> <p>Press the Right Key  to change to Screen 3</p> <p>Press the Left Key  to change to Screen 1</p>	<p style="text-align: center;">Dash Board: Screen 2 for AC Current</p> <p>Screen 2 displays the Inverter Current (Inv. I) and the Grid Current (Grid. I)</p> <ul style="list-style-type: none"> Pressing the Right Key  will change the display to Screen 3 for AC Power Pressing the Left Key  will change the display to Screen 1 for AC Voltages <p>NOTE: In Inverter Mode, the output current will be equal to the Inverter Current (Inv. I). Grid Current (Grid. I) will show 0.0 A. In Pass-through Mode, the output current will be equal to Grid Current (Grid. I). Inverter Current (Inv. I) will show 0.0A.</p>

SECTION 9 | Operation

TABLE 9.2 DASHBOARD SCREENS (Continued)

<p>Dash Board: Screen 3</p> <div style="border: 1px solid black; padding: 5px; width: fit-content; margin: 10px auto;"> <p>Inv. P 1200.0 W Grid.P 0.0 W</p> </div> <p>Press the Right Key  to change to Screen 4</p> <p>Press the Left Key  to change to Screen 2</p>	<p>Dash Board: Screen 3 for AC Power</p> <p>Screen 3 displays the Inverter Power (Inv. P) and the Grid Output Power (Grid. P)</p> <ul style="list-style-type: none"> Pressing the Right Key  will change the display to Screen 4 for Frequency Pressing the Left Key  will change the display to Screen 2 for AC Currents <p>NOTE: In Inverter Mode, the output power will be equal to the Inverter Power (Inv. P). Grid Power (Grid. P) will show 0.0 W. In Pass-through Mode, the output power will be equal to Grid Power (Grid. P). Inverter Power (Inv. P) will show 0.0W</p>
<p>Dash Board: Screen 4</p> <div style="border: 1px solid black; padding: 5px; width: fit-content; margin: 10px auto;"> <p>Inv. F 60.0 Hz Grid.F 60.0 Hz</p> </div> <p>Press the Right Key  to change to Screen 5</p> <p>Press the Left Key  to change to Screen 3</p>	<p>Dash Board: Screen 4 for Frequency</p> <p>Screen 4 displays the Inverter Frequency (Inv. F) and the Grid Frequency (Grid. F)</p> <ul style="list-style-type: none"> Pressing the Right Key  will change the display to Screen 5 for DC Input Voltage Pressing the Left Key  will change the display to Screen 3 for AC Power <p>NOTE: In Inverter Mode, the output frequency will be equal to the Inverter Frequency (Inv. F). In Pass-through Mode, the output frequency will be equal to Grid Frequency (Grid. F).</p>
<p>Dash Board: Screen 5</p> <div style="border: 1px solid black; padding: 5px; width: fit-content; margin: 10px auto;"> <p>V in: 24.0 VDC</p> </div> <p>Press the Right Key  to change to Screen 1</p> <p>Press the Left Key  to change to Screen 4</p>	<p>Dash Board: Screen 5 for DC Input Voltage</p> <p>Screen 5 displays the DC Input Voltage</p> <ul style="list-style-type: none"> Pressing the Right Key  will change the display to Screen 1 for DC Input Voltage Pressing the Left Key  will change the display to Screen 4 for AC Power

9.8 PROGRAMMING OF OPERATING PARAMETERS

The values / settings of various operating parameters can be programmed to suit specific application requirements. Section 10 provides details of the Default settings and the procedure to change the settings, if required, to suit the desired operating conditions.

Some of the more important parameters to be checked / programmed are as follows:

- Output voltage through programmable parameter "Output V". Refer to Section 10.2.3.1
- Output frequency through programmable parameter "Output FREQ". Refer to Section 10.2.3.2

SECTION 9 | Operation

- “Off- line” and “On- line” modes of operation through programmable parameter “Inverter Mode”. Refer to description of these modes at Section 5.5 and programming information at Section 10.2.3.4.
- “Synchronized” and “Unsynchronized” transfer through programmable parameters “Transfer Type” and “Sync FREQ”. Refer to description of these parameters at Section 5.6 and programming information at Section 10.2.3.5 for “Transfer Type” and Section 10.2.3.3 for “Sync FREQ”.

9.9 OPERATIONAL INFORMATION

Operating conditions of the unit can be monitored through the following:

- Front Panel LEDs (2,3,4,5 in Fig 6.1): See Table 9.0 for details.
- LCD “Dashboard”: 5 scrollable screens are available on the LCD “Dashboard”. Refer to Section 9.7 and Table 9.2 for details.

9.10 OPERATION OF ALARMS AND PROTECTIONS

Refer to Section 11 for details on alarms and protections. Table 11.1 gives consolidated details of the status of front panel LEDs, Buzzer and LCD messaging.

Relay based remote signaling of alarms and protections are also available. Refer to Section 11.2.2 for details.

9.11 REMOTE PARAMETER MONITORING AND SETUP USING WIRED USB / RS-232 SERIAL COMMUNICATION PROTOCOL

A remote computer with appropriate Terminal Emulator Program may be used to communicate with the unit through wired USB / RS-232 Serial Communication Protocol. Specified text commands are used to check the status of various operating parameters and alarm / fault warnings. Specified text commands are also used to query the status / change the value of all the programmable parameters.

Refer to Section 12 for details.

9.12 WEB BROWSER BASED MONITORING AND SNMP (SIMPLE NETWORK MANAGEMENT PROTOCOL) USING ETHERNET CONNECTION

The unit supports the following Web Browser based monitoring and SNMP (Simple Network Management Protocol) using Ethernet connection:

- Monitoring of operating parameters and status of alarm / fault warnings
- E-mail notification of warnings i.e. all alarms and fault conditions
- Only monitoring of values of all the programmable parameters that have been set by the user. Please note that this application does not allow changing of values of the programmable parameters.
- SNMP (Simple Network Management Protocol). Trap messages for specified abnormal conditions can be notified to the SNMP Manager.

Refer to Section 13 for details.

9.13 FIRMWARE UPGRADE / BACKUP

This unit supports firmware upgrade and backup.

Refer to Section 14 for details.

SECTION 10 | Programming of Operating Parameters

10.1 MENU MAP FOR PROGRAMMABLE OPERATING PARAMETERS

The values / settings of various operating parameters can be programmed to suit specific application requirements. Refer to the Menu Map at Fig 10.1 to navigate to the setting screen of the desired parameter. Specifications of the parameters shown in the Menu Map are detailed in Table 10.1.

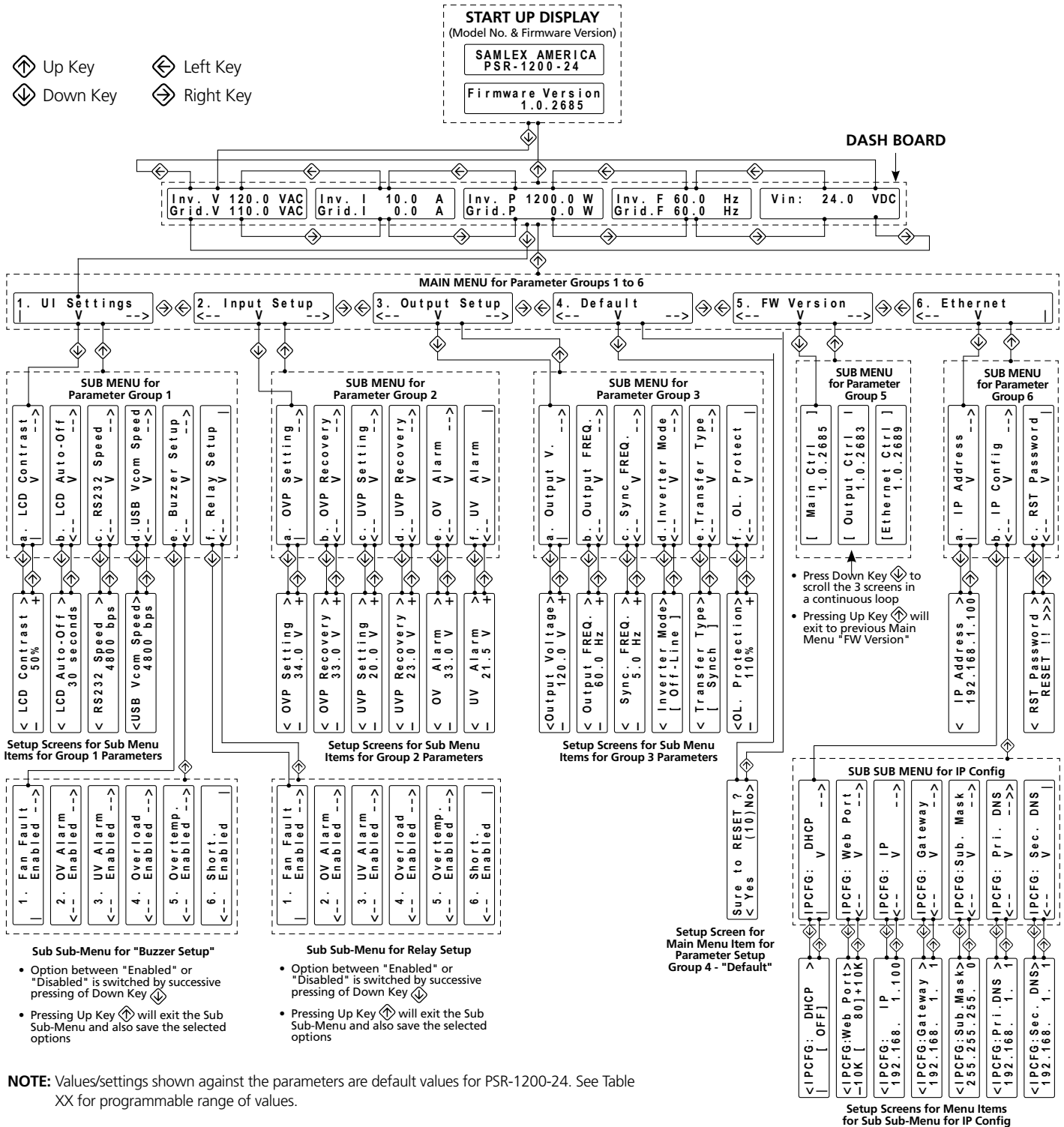

Fig 10.1 Menu Map for Programmable Operating Parameters

SECTION 10 | Programming of Operating Parameters

10.2 SPECIFICATIONS OF PROGRAMMABLE PARAMETERS IN THE MENU MAP AT FIG 10.1

Table 10.1 provides list of programmable parameters shown in the Menu Map at Fig 10.1 along with their specifications i.e. their programmable ranges, setup options and default values.

TABLE 10.1 PROGRAMMABLE PARAMETERS (REFER TO MENU MAP AT FIG 10.1)					
Menu (1)	Sub Menu (for Parameter Groups 1 to 6) (2)	Sub Menu Item (Programmable Parameter) (3)	Programmable Range of Sub Menu Item Programmable Parameter) (4)	Default Setting (5)	
Main Menu (For Parameter Setup Groups 1 to 6)	Group 1 Parameters 1. UI Setting	a. LCD Contrast	0% to 100%	50%	
		b. LCD Auto-Off	20 to 180 sec or DISABLE	60 sec	
		c. RS232 Speed	1200/2400/4800/9600/14400/19200/ 24000/28800	4800	
		d. USBVCOM Speed (USBVCOM: USB Virtual Communication)	1200/2400/4800/9600/14400/19200/ 24000/28800	4800	
		e. Buzzer Setup	1. Fan Fault	Enabled	Enabled
				Disabled	
			2. OV Alarm (OV: Over Voltage)	Enabled	Enabled
				Disabled	
			3. UV Alarm (UV: Under Voltage)	Enabled	Enabled
				Disabled	
		4. Overload	Enabled	Enabled	
			Disabled		
		5. Overtemp (Over Temperature)	Enabled	Enabled	
			Disabled		
	6. Short (Short Circuit)	Enabled	Enabled		
		Disabled			
	f. Relay Setup	1. Fan Fault	Enabled	Enabled	
			Disabled		
		2. OV Alarm (OV: Over Voltage)	Enabled	Enabled	
	Disabled				
	3. UV Alarm (UV: Under Voltage)	Enabled	Enabled		
		Disabled			
	f. Relay Setup	4. Overload	Enabled	Enabled	
			Disabled		
5. Overtemp (Over Temperature)		Enabled	Enabled		
	Disabled				
6. Short (Short Circuit)	Enabled	Enabled			
	Disabled				
Group 2 Parameters 2. Input Setup	a. OVP Setting (Over Voltage Protection Setting)	PSR-1200-24: 25.0 to 35.0 VDC	34.0 VDC		
		PSR-1200-48: 50.0 to 62.0 VDC	60.0 VDC		
	b. OVP Recovery (Over Voltage Protection Recovery)	PSR-1200-24: 24.5 to 34.5 VDC	33.0 VDC		
		PSR-1200-48: 49.0 to 61.0 VDC	58.0 VDC		
	c. UVP Setting (Under Voltage Protection Setting)	PSR-1200-24: 17.0 to 23.0 VDC	20.0 VDC		
		PSR-1200-48: 34.0 to 46.0 VDC	40.0 VDC		
	d. UVP Recovery (Under Voltage Protection Recovery)	PSR-1200-24: 17.5 to 23.5 VDC	23.0 VDC		
		PSR-1200-48: 35.0 to 47.0 VDC	46.0 VDC		

SECTION 10 | Programming of Operating Parameters

TABLE 10.1 PROGRAMMABLE PARAMETERS (REFER TO MENU MAP AT FIG 10.1) (Continued)

Menu (1)	Sub Menu (for Parameter Groups 1 to 6) (2)	Sub Menu Item (Programmable Parameter) (3)	Programmable Range of Sub Menu Item Programmable Parameter) (4)	Default Setting (5)	
Main Menu (For Parameter Setup Groups 1 to 6)	Group 2 Parameters 2. Input Setup	e. OV Alarm (Over Voltage Alarm)	PSR-1200-24: 25.0 to 35.0 VDC PSR-1200-48: 50.0 to 62.0 VDC	33.0 VDC 56.0 VDC	
		f. UV Alarm (Under Voltage Alarm)	PSR-1200-24: 17.0 to 23.0 VDC PSR-1200-48: 34.0 to 46.0 VDC	21.5 VDC 43.0 VDC	
		Group 3 Parameters 3. Output Setup	a. Output V. (Output Voltage)	100.0 to 120.0 VAC	120.0 VAC
			b. Output FREQ. (Output Frequency)	45.0 to 65.0 Hz	60.0 Hz
	c. Sync FREQ (Synchronizable Frequency)		0.1 to 7.0 Hz	5.0 Hz	
	d. Inverter Mode		[Off-Line] OR [On-Line]	[Off-Line]	
	e. Main Menu		[Synch] OR [Unsynch] (Synchronized OR Unsynchronized)	[Synch]	
	f. OL Protect (Overload Protection)		100% to 110%	110%	
	Group 4 Parameters 4. Default	Sure to Reset?	Yes OR No (10 sec countdown to select Yes)	No	
	Group 5 Parameters 5. FW Version	[Main Ctrl] (Main Controller) x.x.xxxx	-	-	
		[Output Ctrl] (Output Controller) x.x.xxxx			
		[Ethernet Ctrl] (Ethernet Controller) x.x.xxxx			
	Group 6 Parameters 6. Ethernet	a. IP Address	192.168.1.100	192.168.1.100	
		b. IP Config (IP Configuration)			
		• IPCFG:DHCP	[ON] or [OFF]	[ON]	
		• IPCFG:Web Port	[1 to 65535]	[80]	
		• IPCFG: IP	xxx.xxx.xxx.xxx (xxx from 0 to 255)	192.168.1.100	
		• IPCFG: Gateway	xxx.xxx.xxx.xxx (xxx from 0 to 255)	192.168.1.1	
		• IPCFG: Sub. Mask	xxx.xxx.xxx.xxx (xxx: 0, 128, 192, 224, 240, 248, 252, 254, 255)	255.255.255.0	
		• IPCFG: Pri DNS	xxx.xxx.xxx.xxx (xxx from 0 to 255)	192.168.1.1	
• IPCFG: Sec DNS		xxx.xxx.xxx.xxx (xxx from 0 to 255)	192.168.1.1		
c. RST Password		RESET !!	-		

SECTION 10 | Programming of Operating Parameters

10.2 DETAILS OF PROGRAMMABLE PARAMETERS LISTED IN TABLE 10.1 AND IN FIG 10.1

Table 10.1 provides list of programmable parameters, their programmable ranges, setup options and default values. Menu Map at Fig 10.1 shows the path to navigate to the setting screen of the desired parameter. Details of parameters are given in the succeeding Sub-Sections.

10.2.1 Main Menu for Parameter Setup Groups 1-6 > Group 1 “UI Setting” > Sub-Menu for “UI Setting”

10.2.1.1 “a. **LCD Contrast**”: Sets LCD screen contrast.

Parameter	Programmable Range	Default
a. LCD Contrast	0% to 100%	50%

NOTE: During operation, the LCD contrast can be adjusted on as required basis and the setting will be saved automatically when the setting screen is exited. There will no Save / Discard action required for the new % of contrast setting as done for Save / Discard action for other programmable parameters. Once the unit is switched OFF, the LCD contrast will be reset to the Default value of 50%.

10.2.1.2 “b. **LCD Auto-Off**”: This parameter can be programmed to control the time the LCD is required to remain in ON condition. Programmable range is (i) 20 to 180 sec (Default is 60 sec) or (ii) DISABLE i.e. ON all the time.

- When the LCD Display is in Auto-Off condition, it can be switched back to the Startup Display Screen by pressing the Down Key ⏴
- To switch off the LCD Screen before the expiry of the “LCD Auto-Off” time period, press the Up Key ⏵

Parameter	Programmable Range	Default
b. LCD Auto-Off	20 to 180 sec or DISABLE	60 sec

10.2.1.3 “c. **RS232 Speed**”: Sets the speed of communication in Bits per Second (bps) over the RS-232 Serial Communication Port.

Parameter	Programmable Range	Default
c. RS232 Speed	1200/2400/4800/9600/14400/19200/24000/28800	4800

10.2.1.4 “d. **USB Virtual COM Speed**”: Sets the speed of communication in Bits per Second (bps) over the USB Virtual Communications Port.

Parameter	Programmable Range	Default
d. USBVCOM Speed (USBVCOM: USB Virtual Communication)	1200/2400/4800/9600/14400/19200/24000/28800	4800

SECTION 10 | Programming of Operating Parameters

10.2.1.5 “e. Buzzer Setup”: A Buzzer has been provided to attract attention when the unit sees any one or combination of 6 types of alarm and fault conditions. Options and Default settings are shown below. Default setting is “Enabled” for all the 6 conditions which means that the Buzzer will be switched ON if any one of the 6 alarm / fault condition is seen.

Parameter	Fault / Alarm	Options	Default
e. Buzzer setup	1. Fan Fault	Enabled	Enabled
		Disabled	
	2. OV Alarm (OV: Over Voltage)	Enabled	Enabled
		Disabled	
	3. UV Alarm (UV: Under Voltage)	Enabled	Enabled
		Disabled	
	4. Overload	Enabled	Enabled
		Disabled	
	5. Overtemp (Over Temperature)	Enabled	Enabled
		Disabled	
	6. Short (Short Circuit)	Enabled	Enabled
		Disabled	

10.2.1.6 “f. Relay Setup”: An internal SPDT Relay (Contact rating 240VAC, 16A) has been provided for signaling of any one or combination of 6 types of alarm and fault conditions. Options and Default settings are shown below. Default setting is “Enabled” for all the 6 conditions which means that the relay will be energized if any one of the 6 alarm / fault condition is seen.

Relay contacts are accessible through 3 terminals marked NO (Normally Open), COM Common and NC (Normally Closed) in the 7-Way Terminal Block at the back of the unit (12, Fig 6.2).

Parameter	Fault / Alarm	Options	Default
f. Relay setup	1. Fan Fault	Enabled	Enabled
		Disabled	
	2. OV Alarm (OV: Over Voltage)	Enabled	Enabled
		Disabled	
	3. UV Alarm (UV: Under Voltage)	Enabled	Enabled
		Disabled	
	4. Overload	Enabled	Enabled
		Disabled	
	5. Overtemp (Over Temperature)	Enabled	Enabled
		Disabled	
	6. Short (Short Circuit)	Enabled	Enabled
		Disabled	

SECTION 10 | Programming of Operating Parameters

10.2.2 Main Menu for Parameter Setup Groups 1-6 > Group 2 "Input Setup" > Sub-Menu for "Input Setup"

10.2.2.1 "a. OVP Setting": Sets the Over Voltage Protection (OVP) threshold on the DC input side. If the DC input voltage rises to the programmed threshold in Inverting Mode, the AC output of the Inverter will be shut down.

Parameter	Programmable Range	Default
a. OVP Setting (Over Voltage Protection Setting)	PSR-1200-24: 25.0 to 35.0 VDC	34.0 VDC
	PSR-1200-48: 50.0 to 62.0 VDC	60.0 VDC

10.2.2.2 "b. OVP Recovery": Sets the voltage threshold for automatic recovery / reset from OVP condition explained at Section 10.2.2.1 above.

Parameter	Programmable Range	Default
b. OVP Recovery (Over Voltage Protection Recovery)	PSR-1200-24: 24.5 to 34.5 VDC	33.0 VDC
	PSR-1200-48: 49.0 to 61.0 VDC	58.0 VDC

10.2.2.3 "c. UVP Setting": Sets the Under Voltage Protection (UVP) threshold on the DC input side. If the DC input voltage falls to the programmed threshold or below continuously for 0.1 sec in Inverting Mode, the AC output of the Inverter will be shut down.

Parameter	Programmable Range	Default
c. UVP Setting (Under Voltage Protection Setting)	PSR-1200-24: 17.0 to 23.0 VDC	20.0 VDC
	PSR-1200-48: 34.0 to 46.0 VDC	40.0 VDC

10.2.2.4 "d. UVP Recovery": Sets the voltage threshold for automatic recovery / reset from UVP condition explained at Section 11.2.2.3 above.

Parameter	Programmable Range	Default
d. UVP Recovery (Under Voltage Protection Recovery)	PSR-1200-24: 17.5 to 23.5 VDC	23.0 VDC
	PSR-1200-48: 35.0 to 47.0 VDC	46.0 VDC

10.2.2.5 "e. OV Alarm": Sets the voltage threshold for alarm for Over Voltage (OV) on the DC input side. If the DC input voltage rises to the programmed threshold, the following indications will be activated (The Inverter Section will not shut down at this stage but will shut down if the voltage further rises to the programmed threshold of "OVP Setting" (See Section 10.2.2.1):

- LCD Screen (6, Fig 6.1) will display "*** Warning** Over voltage detected!!"
- LED marked "ALARM" (5, Fig 6.1) will be lighted (Orange)
- Buzzer Alarm will be activated (if "Enabled" – See Buzzer Setup at 10.2.1.5). At the same time, the SPDT Signaling Relay will be activated (when "Enabled" – Relay Setting at Section 10.1.2.6)

Parameter	Programmable Range	Default
e. OV Alarm (Over Voltage Alarm)	PSR-1200-24: 25.0 to 35.0 VDC	33.0 VDC
	PSR-1200-48: 50.0 to 62.0 VDC	56.0 VDC

SECTION 10 | Programming of Operating Parameters

NOTE: OV Alarm hysteresis is as follows:

- (i) 0.5V for PSR-1200-24: The OV Alarm will automatically reset when the voltage drops to 0.5V below the programmed OV setting
- (ii) 1.0 V for PSR-1200-48: The OV Alarm will automatically reset when the voltage drops to 1.0V below the programmed OV setting

10.2.2.6 “f. UV Alarm”: Sets the voltage threshold for alarm for Under Voltage (UV) on the DC input side. If the DC input voltage falls to the programmed threshold, the following indications will be activated (The Inverter Section will not shut down at this stage but will shut down if the voltage further drops to the programmed threshold of “UVP Setting” (See Section 11.2.2.3):

- LCD Screen (6, Fig 6.1) will display “** Warning** Under voltage detected!!”
- LED marked “ALARM” (5, Fig 6.1) will be lighted (Orange)
- Buzzer Alarm will be activated (if “Enabled” – See Buzzer Setup at 10.2.1.5). At the same time, the SPDT Signaling Relay will be activated (when “Enabled” – Relay Setting at Section 10.1.2.6)

Parameter	Programmable Range	Default
f. UV Alarm (Under Voltage Alarm)	PSR-1200-24: 17.0 to 23.0 VDC	21.5 VDC
	PSR-1200-48: 34.0 to 46.0 VDC	43.0 VDC

NOTE: UV Alarm hysteresis is as follows:

- (i) 0.5V for PSR-1200-24: The UV Alarm will automatically reset when the voltage rises to 0.5V above the programmed UV setting
- (ii) 1.0 V for PSR-1200-48: The UV Alarm will automatically reset when the voltage rises to 1.0V above the programmed UV setting.

10.2.3 Main Menu for Parameter Setup Groups 1-6 > Group 3 “Output Setup” > Sub-Menu for “Output Setup”

10.2.3.1 “a. Output V”: Sets the output voltage of the Inverter Section.

Parameter	Programmable Range	Default
a. Output V. (Output Voltage)	100.0 to 120.0 VAC	120.0 VAC

10.2.3.2 “b. Output FREQ”: Sets the output frequency of the Inverter Section.

Parameter	Programmable Range	Default
b. Output FREQ. (Output Frequency)	45.0 to 65.0 Hz	60.0 Hz

10.2.3.3 “c. Sync FREQ”: This parameter is used to set the “Synchronizable Frequency Window” of the AC GRID. The Inverter will be able to synchronize the frequency and phase of its output voltage with the frequency and phase of the AC GRID voltage only if the AC GRID frequency remains within the “Synchronizable Frequency Window”.

Parameter	Programmable Range	Default
c. Sync FREQ (Synchronizable Frequency)	0.1 to 7.0 Hz	5.0 Hz

SECTION 10 | Programming of Operating Parameters

“Synchronizable Frequency Window” = Programmed value of “Output FREQ” of the Inverter (Section 10.2.3.2 above) +/- Programmed value of the “Sync FREQ”. For example, if the “Output Frequency” of the Inverter Section is set at 60 Hz (Default) and “Sync. FREQ” is set at 5 Hz (Default), the “Synchronizable Frequency Window” will be 60Hz ± 5Hz or “55Hz to 65Hz”.

As long as the AC Grid frequency is within the “Synchronizable Frequency Window”, the frequency and phase of the Inverter’s output voltage will be kept synchronized with the frequency and phase of the AC Grid.

See Section 5.6.4 for details

10.2.3.4 “d. Inverter Mode”: This parameter selects the primary and backup sources of power for powering the AC loads as follows:

Off-Line Mode: In this mode, the AC GRID input is the primary source of power and the Inverter is the backup source.

On- Line Mode: In this mode, the Inverter is the primary source of power and the AC GRID input is the backup source of power.

Refer to Section 5.5 for details of On-Line and Off-Line modes of operation.

Parameter	Programmable Range	Default
d. Inverter Mode	Off-Line or, On-Line	Off-Line

10.2.3.5 “e. Transfer Type”: The AC load can be transferred between the AC GRID and the Inverter based on 2 options - “Synchronized” or “Unsynchronized”.

Refer to Section 5.6 for details of operation under these 2 types of transfer.

Parameter	Programmable Range	Default
e. Transfer Type	Synch (Synchronized) or, UnSynch (Unsynchronized)	Synch (Synchronized)

10.2.3.5 “f. OL Protect”: The Inverter will shut down if the AC load draws higher than the programmed % of overload power for more than 2 to 3 sec.

Overload power can be programmed from 100% to 110% of the rated power through this parameter.

Refer to Section 11.4 for detailed information on overload protection.

Parameter	Programmable Range	Default
f. OL Protection	100% to 110%	110%

SECTION 10 | Programming of Operating Parameters

10.3 PROGRAMMING OF PARAMETERS





10.3.1 List of Programmable Parameters

The values / settings of various operating parameters can be programmed to suit specific application requirements.

Table 10.1 provides list of programmable parameters, their programmable ranges, setup options and default values.

10.3.2 Overall Menu Map

Fig 10.1 provides overall Menu Map for all the Operating and Setup Screens. Structure of this Menu Map is explained in the succeeding Sections.

Navigation through the Menu Maps is carried out through the Left , Right , Up  and Down  Keys (7, Fig 6.1).















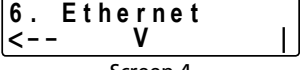

All the programmable parameters have been divided into 6 Parameter Setup Groups 1 to 6 that are displayed in the Main Menu e.g. Parameter Setup Group 3 is for parameters related to “Output Setup” (See Column 2 in Table 10.1 and Menu Screen in Fig 10.1).

Parameters included in a “Parameter Setup Group” are displayed in the Sub-Menu for that Group (see Column 3 of Table 10.1 and Sub-Menu screens in Fig 10.1). For example, parameter “Output V” is displayed at Item “a” in the Sub-Menu for Parameter Setup Group 3 for “Output Setup”. Each Parameter has a Setup Screen where the desired value / option of the parameter is displayed / selected. Some parameters in Sub-Menus like “Buzzer Setup”, “Relay Setup” and “IP Config” have additional related parameters that are displayed in the “Sub Sub-Menu” screens.

10.3.3 Structure of Programming Screens

Structure of various screens used in MAIN MENU, SUB MENUS and Setup Screens is explained in Table 10.2:

SECTION 10 | Programming of Operating Parameters

TABLE 10.2 STRUCTURE OF PROGRAMMING SCREENS		
Types of Screens (Column 1)	Examples of Screens (Column 2)	Remarks (Column 3)
Main Menu and Sub Menu Screens	 <p>Screen 1</p>	<ul style="list-style-type: none"> • 1st line, left end: <ul style="list-style-type: none"> ▪ Numeral 1 to 6 show the Group No. in the MAIN MENU (e.g. Screen 1 shows Group 1 "UI Setting" in the MAIN MENU) ▪ Alphabets "a" to "f" show the Parameter Item Number in the SUB MENU (e.g. Screen 2 shows SUB MENU Parameter "a. LCD Contrast") • 1st line, center <ul style="list-style-type: none"> ▪ Name of the Group / Parameter • 2nd line, left end <ul style="list-style-type: none"> ▪ Left arrow "<- -" (e.g. Screens 3 & 4): Shows that there are additional screens in the Menu on the left of this screen that can be accessed by successive pressing of the Left Button . ▪ Vertical bar " " (e.g. Screens 1 & 2): Shows that there are no additional screens in the Menu on the left of this screen. <ul style="list-style-type: none"> - NOTE: This screen will be the 1st screen in MAIN / SUB MENU • 2nd Line, right end <ul style="list-style-type: none"> ▪ Right Arrow "->" (Screens 1 & 2): Shows that there are additional screens in the Menu on the right of this screen that can be accessed by successive pressing of the Right Button . ▪ Vertical bar " " (e.g. Screen 4): Shows that there are no additional screens in the Menu on the right of this screen. <ul style="list-style-type: none"> - NOTE: This screen will be the last screen in MAIN / SUB MENU • 2nd Line, middle arrow "V": The middle arrow mark "V" shows that pressing the Down Key  will (i) enter SUB MENU (Screen 2) from MAIN MENU (Screen 1) or (ii) Setup Screen (Screen 3) from SUB MENU (Screen 2).
	 <p>Screen 2</p>	
	 <p>Screen 3</p>	
	 <p>Screen 4</p>	
Sub Menu Item Screens	 <p>Screen 5</p>	<p>Example 1: Changing parameter value (Screen 5 on the left) The 1st line of the screen shows the following:</p> <ul style="list-style-type: none"> • 1st line, center <ul style="list-style-type: none"> ▪ Name of the Parameter • 2nd line, center <ul style="list-style-type: none"> ▪ Value of the parameter when the parameter setup screen was entered from the SUB MENU • Left ends "<" and "-" <ul style="list-style-type: none"> ▪ Left arrow "<" & minus sign "-" mean that pressing the Left Button  will decrease the value of the parameter • Right ends ">" and "+" <ul style="list-style-type: none"> ▪ Right arrow ">" & plus sign "+" means that pressing the Right Button  will increase the value of the parameter
	 <p>Screen 6</p>	<p>Example 2: Changing parameter option (Screen 6 on the left) The 1st line of the screen shows the following:</p> <ul style="list-style-type: none"> • 1st line, center <ul style="list-style-type: none"> ▪ Name of the Parameter • 2nd line, center <ul style="list-style-type: none"> ▪ Option of the parameter when the parameter setup screen was entered from the SUB MENU • 1st line right end ">" <ul style="list-style-type: none"> ▪ Right arrow ">" & plus sign "+" means that pressing the Right Button  will switch to the other option • 1st line, left end "<" <ul style="list-style-type: none"> ▪ Left arrow "<" means that pressing the Left Button  will switch to the previous option
Save / Discard Screen		<p>When this screen is displayed for the first time, the Blinking Cursor "<<<" will appear against "Save". Press the Down Key  to move the Blinking Cursor "<<<" next to "Discard" When the Up Key  is pressed, Save / Discard action will initiated based on the position of the Blinking Cursor. After Save / Discard action is completed, the screen will move back to the same DASH BOARD screen from where it had exited for programming.</p>

SECTION 10 | Programming of Operating Parameters

10.3.4 Programming Procedure

Refer to the Overall Menu Map at Fig 10.1.

From Table 10.1, first identify the parameter to be changed. Then, refer to the Menu Map at Fig 10.1 and determine the navigating path to access the "Set UP Screen" for the desired parameter. Typical procedure will be as follows:

When the unit is ON, the LCD will display up to 2 lines of operating parameters through one of the 5 "Dash Board" Screens (If Startup Display is being shown, press the Down key \Downarrow to enter the Dash Board). Typical programming steps are explained in Table 10.3 below for changing value of parameter:

TABLE 10.3 EXAMPLE OF PROGRAMMING STEPS FOR CHANGING PARAMETER		
Step No.	Action	Display Screens
1	From the any screen in the DASH BOARD, press the Down Key \Downarrow to enter the MAIN MENU that consists of Parameter Setup Groups 1 to 6	
2	MAIN MENU Screen for Parameter Group 1: "1. UI Setting" will be displayed as shown on the right:	
3	Press the Right Key \Rightarrow to move to Parameter Group 2: "2. Input Setup" as shown on the right	
4	Press the Down key \Downarrow to move to SUB MENU Parameter: " a. OVP Setting" as shown on the right	
5	Press the Down Key \Downarrow to move to the Setup Screen for parameter "OVP Setting" as shown on the right. Default value of 34.0 V will be displayed	 In this screen, pressing the Right key \Rightarrow increases (+) the value & pressing the Left Key \Leftarrow reduces the value.
6	Use the Right Key \Rightarrow to increase (+) the value to say 34.5V as shown on the right	 In this screen, pressing the Right key \Rightarrow increases (+) the value & pressing the Left Key \Leftarrow reduces the value.
7	Press the Up Key \Uparrow . The screen will move back to the SUB MENU Item "a" for parameter " OVP Setting" as shown on the right	
8	Press the Up Key \Uparrow again. The screen will move back to the MAIN MENU item "2" for " Input Setup" as shown on the right	
9	Press the Up Key \Uparrow again. Save / Discard screen as shown on the right will be displayed. Blinking Cursor "<<<" will appear against "Save" TO SAVE: <ul style="list-style-type: none"> Press the Left Key \Leftarrow After saving is completed, the screen will move back to the same DASH BOARD screen from where it had exited for programming (Step 1) TO DISCARD: <ul style="list-style-type: none"> Press the Down Key \Downarrow to move the Blinking Cursor "<<<" next to "Discard" Press the Left Key \Leftarrow After saving is completed, the screen will move back to the same DASH BOARD screen from where it had exited for programming (Step 1) 	 "<<<" will be blinking

SECTION 11 | Protections and Alarms

11.1 PROTECTIONS AND ALARMS

Details of protections and alarms have been provided as follows:

- Table 11.1 provides details of protections resulting in shut down of the Inverter.
- Table 11.2 provides details of alarms

11.2 BUZZER AND RELAY BASED REMOTE SIGNALLING

11.2.1 Buzzer: An internal Buzzer has been provided to attract attention when the unit sees any one or combination of 6 types of alarm and fault conditions. Options and Default settings are shown below. Default setting is "Enabled" for all the 6 conditions which means that the Buzzer will be switched ON if any one of the 6 alarm / fault condition is seen. For programming details, refer to Fig 10.1 / Table 10.1 under Main Menu for Parameter Group 1 – "UI Setting" / Sub Menu for Parameter Group 1, Parameter (e) – "Buzzer Setup" (Section 10.2.1.5).

Parameter	Fault / Alarm	Options	Default
e. Buzzer setup	1. Fan Fault	Enabled	Enabled
		Disabled	
	2. OV Alarm (OV: Over Voltage)	Enabled	Enabled
		Disabled	
	3. UV Alarm (UV: Under Voltage)	Enabled	Enabled
		Disabled	
	4. Overload	Enabled	Enabled
		Disabled	
	5. Overtemp (Over Temperature)	Enabled	Enabled
		Disabled	
	6. Short (Short Circuit)	Enabled	Enabled
		Disabled	

11.2.2 Relay based Wired Remote Signaling of Alarm and Fault Conditions: An internal SPDT Relay (Contact rating 240VAC, 16A) has been provided for wired signaling of any one or combination of 6 types of alarm and fault conditions. Options and Default settings are shown below. Default setting is "Enabled" for all the 6 conditions which means that the relay will be energized if any one of the 6 alarm / fault condition is seen.

Relay contacts are accessible through 3 terminals marked NO (Normally Open), COM Common) and NC (Normally Closed) in the 7-Way Terminal Block at the back of the unit (12, Fig 6.2)

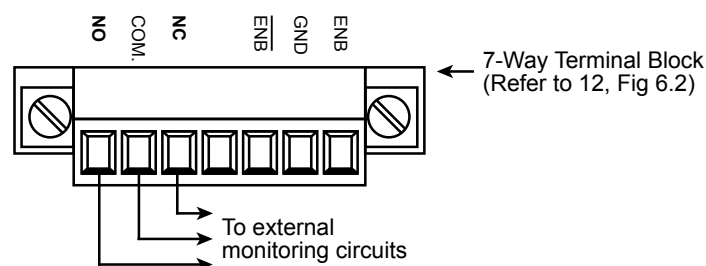

SECTION 11 | Protections and Alarms

Parameter	Fault / Alarm	Options	Default
f. Relay setup	1. Fan Fault	Enabled	Enabled
		Disabled	
	2. OV Alarm (OV: Over Voltage)	Enabled	Enabled
		Disabled	
	3. UV Alarm (UV: Under Voltage)	Enabled	Enabled
		Disabled	
	4. Overload	Enabled	Enabled
		Disabled	
	5. Overtemp (Over Temperature)	Enabled	Enabled
		Disabled	
	6. Short (Short Circuit)	Enabled	Enabled
		Disabled	

11.3 SURGE / PEAK SURGE POWER PROTECTION

Surge power (also called Peak Surge Power) is the maximum power that the inverter can sustain for a short time. The Surge/Peak Surge Power differs from the Continuous Power which refers to the amount of power that the inverter can supply continuously. The Surge/Peak Surge Power is higher than the Continuous Power and only required for a limited amount of time.

Most circuits / equipment especially those with electromechanical components such as motors, fans, actuators, pumps, compressors etc. require start-up currents that are usually higher than the rated steady state current that the equipment draws when operating normally. This initial start-up current may be anywhere up to 10 times the normal steady state operating current, but only lasts for a short period of time, typically between a few microseconds to a few seconds. The inverter should be able to handle such spikes without interrupting the operation or the function of the load. Therefore, rather than size the inverter for the worst case short duration surge/peak current, a good alternative would be to use an inverter that can handle the short term surge/peak current, yet provide (non-peak) continuous steady state operating current.

This inverter has Surge/Peak Surge Power rating of 2000W for duration for up to around 2 sec (2000W is the averaged value for less than 8ms that is delivered every ½ cycle of the voltage waveform). If the load continues to draw 2000W for more than 2 sec, the output of the Inverter will be shut down by the "Overload Protection" circuitry. See Table 10.1 under "Overload Protection" for status of front panel LEDs and LCD messaging resulting from this condition. **NOTE: When "Overload Protection" is activated, the Inverter will be latched in shut down condition. To reset the Inverter, switch OFF the Inverter by switching the 3-Position Rocker Switch (1, Fig 6.1) to OFF position. Wait for 10 sec and switch on again.**

11.4 OVERLOAD PROTECTION

The Inverter will shut down if the AC load draws higher than the programmed % of overload power for more than 2 to 3 sec. Overload power can be programmed from 100% to 110% of the rated power through programmable parameter called "OL Protection". For programming details, refer to Fig 10.1 / Table 10.1

SECTION 11 | Protections and Alarms

under Main Menu for Parameter Group 3 – "Output Setup" / Sub Menu for Parameter Group 3, Parameter (f) – "OL. Protect" (Section 10.2.3.5). See Table 11.1 under "Overload Protection" for status of front panel LEDs and LCD messaging resulting from this condition. NOTE: When "Overload Protection" is activated, the Inverter will be latched in shut down condition. To reset the Inverter, switch OFF the Inverter by switching the 3-Position Rocker Switch (1, Fig 6.1) to OFF position. Wait for 10 sec and switch on again.

11.5 SHORT CIRCUIT PROTECTION

11.5.1 Short Circuit Protection when "AC GRID" input is NOT available: When AC input IS NOT available, the AC load will be supplied by the Inverter. The Inverter will shut down if there is a short circuit on its output. Short circuit condition is sensed due to any one or both of the following conditions:

- Output current is more than 24A continuously for 1.2 sec
- Output voltage drops to 80V or below continuously for more than 1.2 sec

See Table 11.1 under "Overload Protection" for status of front panel LEDs and LCD messaging resulting from this condition. NOTE: When "Short circuit Protection" is activated, the Inverter will be latched in shut down condition. To reset the Inverter, switch OFF the Inverter by switching the 3-Position Rocker Switch (1, Fig 6.1) to OFF position. Wait for 10 sec and switch on again.

11.5.2 Short Circuit Protection when "AC GRID" input IS available:

- **11.5.2.1 Parameter "Inverter Mode" is set at "Off-Line" (See Section 10.2.3.4):** When AC GRID input is available, it will be bypassed to the AC output load side and the Inverter will be in standby condition. If there is a short circuit on the AC output load side, the 12A input side circuit breaker (19, Fig 6.2) or the external AC Panel breaker feeding the AC GRID input will trip. The short circuited AC output load side will then be transferred to the Inverter. The inverter will then shut down as described above at Section 11.5.1 under "Short Circuit Protection when AC GRID input is NOT available"
- **11.5.2.2 Parameter "Inverter Mode" is set at "On-Line" (See Section 10.2.3.4):** When AC GRID input is available, it will in standby condition and the AC output load side will be supplied by the Inverter. If there is a short circuit on the AC output load side, the inverter will shut down as described above at Section 11.5.1 under "Short Circuit Protection when "AC GRID" input is NOT available". The short circuited AC output load side will be transferred to the AC GRID input. Due to short circuited AC output load side, the 15A input side circuit breaker (19, Fig 6.2) or the external AC Panel breaker feeding the AC GRID input will trip.

11.6 OVER TEMPERATURE PROTECTION

Temperature of two hot-spots near two internal heat sinks is sensed by Negative Temperature Coefficient (NTC) Resistors NTC1 and NTC2. In case the ambient temperature is higher than the rated value or, if there is inadequate forced air cooling due to fan failure or restricted / blocked ventilation openings (8a in fig 6.1 and 20 in fig 6.2), the temperature inside the unit will continue to rise. The Inverter will shut down due to over temperature if the temperature sensed by either NTC1 or NTC2 rises to 105°C. The Inverter will reset automatically when both the hot spot cool down to 85°C.

See Table 11.1 under "Over Temperature Protection" for status of front panel LEDs and LCD messaging resulting from this condition.

SECTION 11 | Protections and Alarms

11.7 FAN FAILURE ALARM

This alarm / relay based remote signaling is activated if the fan speed reduces or the fan stops.

See Table 11.2 under “Fan Failure” for status of front panel LEDs and LCD messaging resulting from this condition.

11.8 OVER VOLTAGE ALARM

This alarm / relay based remote signaling is activated when the DC input voltage is higher than the value of parameter “OV Alarm”. The alarm is reset automatically as follows:

- PSR-1200-24: 0.5V lower than the value of “OV Alarm”
- PSR-1200-48: 1.0V lower than the value of “OV Alarm”

See Table 11.2 under “Over Voltage Alarm” for status of front panel LEDs and LCD messaging resulting from this condition.

11.9 UNDER VOLTAGE ALARM

This alarm / relay based remote signaling is activated when the DC input voltage is lower than the value of parameter “UV Alarm”. The alarm is reset automatically as follows:

- PSR-1200-24: 0.5V higher than the value of “UV Alarm”
- PSR-1200-48: 1.0V higher than the value of “UV Alarm”

See Table 11.2 under “Under Voltage Alarm” for status of front panel LEDs and LCD messaging resulting from this condition.

TABLE 11.1 PROTECTIONS RESULTING IN SHUT DOWN OF INVERTER								
Protection and reset	AC GRID input conditions	Front panel LED marked “AC GRID” (2, Fig 6.1)	Front panel LED marked “INVERTER” (3, Fig 6.1)	Front panel LED marked “BYPASS” (4, Fig 6.1)	Front Panel LED marked “ALARM” (5, Fig 6.1) will be Red	Buzzer (Parameter “Buzzer Setup” set to Enabled)	Relay for remote signaling of alarm (Parameter Relay Setup set to Enabled)	LCD Display
Overload Protection <ul style="list-style-type: none"> • Load draws power more than programmed value of parameter “OL Protection” continuously for more than 2 to 3 sec, or • Load draws Surge Power higher than 2000W continuously for more than 2 sec Manual Reset Inverter will be latched in shut down condition. To reset, switch OFF by witching the 3-Position Rocker Switch (1, Fig 6.1) to OFF position. Wait for 10 sec and switch on again	AC Grid input available	Green/ Orange	Red	Green	Orange	On	Energized	** Warning ** Over load protection!!
	AC Grid input not available	Off	Red	Off	Orange	On	Energized	

SECTION 11 | Protections and Alarms

TABLE 11.1 PROTECTIONS RESULTING IN SHUT DOWN OF INVERTER (Continued)								
Protection and reset	AC GRID input conditions	Front panel LED marked "AC GRID" (2, Fig 6.1)	Front panel LED marked "INVERTER" (3, Fig 6.1)	Front panel LED marked "BYPASS" (4, Fig 6.1)	Front Panel LED marked "ALARM" (5, Fig 6.1) will be Red	Buzzer (Parameter "Buzzer Setup" set to Enabled)	Relay for remote signaling of alarm (Parameter Relay Setup set to Enabled)	LCD Display
Short circuit Protection <ul style="list-style-type: none"> • Load draws higher than 24A for 1.2 sec, or • Output voltage drops to 80VAC for 1.2 sec Manual Reset Inverter will be latched in shut down condition. To reset, switch OFF by witching the 3-Position Rocker Switch (1, Fig 6.1) to OFF position. Wait for 10 sec and switch on again	AC Grid input available	Green/Orange	Red	Green	Orange	On	Energized	** Warning ** Short circuit protection!!
	AC Grid input not available	Off	Red	Off	Orange	On	Energized	
Over Temperature Protection <ul style="list-style-type: none"> • Temperature of either of two hot-spots near two heat sinks (sensed by NTC1 and NTC2) is higher than 105°C Automatic reset: When the temperature drops to 85°C	AC Grid input available	Green/Orange	Red	Green	Orange	On	Energized	** Warning ** Over temperature protection!!
	AC Grid input not available	Off	Red	Off	Orange	On	Energized	
Over Voltage Protection <ul style="list-style-type: none"> • DC input voltage is higher than the set value of parameter "OVP Setting" Automatic reset: <ul style="list-style-type: none"> ▪ PSR-1200-24: 0.5V lower than " OVP Setting" ▪ PSR-1200-48: 1.0V lower than " OVP Setting" value 	AC Grid input available	Green/Orange	Red	Green	Orange	On	Energized	** Warning ** Over voltage protection!!
	AC Grid input not available	Off	Red	Off	Orange	On	Energized	
Under Voltage Protection <ul style="list-style-type: none"> • DC input voltage is lower than the set value of parameter "UVP Setting" Automatic reset: <ul style="list-style-type: none"> ▪ PSR-1200-24: 0.5V higher than "UVP Setting" ▪ PSR-1200-48: 1.0V higher than "UVP Setting" value 	AC Grid input available	Green/Orange	Red	Green	Orange	On	Energized	** Warning ** Under voltage protection!!
	AC Grid input not available	Off	Red	Off	Orange	On	Energized	

SECTION 11 | Protections and Alarms

TABLE 11.2 ALARMS (UNIT DOES NOT SHUTDOWN)								
Protection and reset	AC GRID input conditions	Front panel LED marked "AC GRID" (2, Fig 6.1)	Front panel LED marked "INVERTER" (3, Fig 6.1)	Front panel LED marked "BYPASS" (4, Fig 6.1)	Front Panel LED marked "ALARM" (5, Fig 6.1) will be Red	Buzzer (Parameter "Buzzer Setup" set to Enabled)	Relay for remote signaling of alarm (Parameter Relay Setup set to Enabled)	LCD Display
Fan Failure • Fan speed drops or fan stops completely	AC Grid input available	Green/ Orange	Green	Green	Orange	On	Energized	** Warning ** Fan failure!!
	AC Grid input not available	Off	Green	Off	Orange	On	Energized	
Over Voltage Alarm • DC input voltage is higher than the value of parameter "OV Alarm" Automatic reset: ▪ PSR-1200-24: 0.5V lower than " OV Alarm" ▪ PSR-1200-48: 1.0V lower than " OV Alarm" value	AC Grid input available	Green/ Orange	Green	Green	Orange	On	Energized	** Warning ** Over voltage detected!!
	AC Grid input not available	Off	Green	Off	Orange	On	Energized	
Under Voltage Alarm • DC input voltage is lower than the value of parameter "UV Alarm" Automatic reset: ▪ PSR-1200-24: 0.5V higher than " UV Alarm" ▪ PSR-1200-48: 1.0V higher than " UV Alarm" value	AC Grid input available	Green/ Orange	Green	Green	Orange	On	Energized	** Warning ** Under voltage detected!!
	AC Grid input not available	Off	Green	Off	Orange	On	Energized	

11.3 WEB BROWSER BASED REMOTE MONITORING OF ALARM AND FAULT CONDITIONS USING WIRED USB / RS-232 SERIAL COMMUNICATION AND INTERNET

8 types of protection / alarm warnings shown in Tables 11.1 and 11.2 can be monitored remotely through a computer as follows:

- Using Wired USB / RS-232 Serial Communication Protocol : Refer to Section 12
 - Connect the unit to the remote computer through USB / RS-232 cable
 - Load Web Browser based Terminal Emulator software on the computer.
 - Use specified text based status queries from the Command Line (See Command Table at Section 12.6)
- Using Ethernet connection (Internet): Refer to Section 13
 - Connect the Ethernet Port on the unit to Internet Router
 - On the remote computer, enter the IP Address of the unit

SECTION 11 | Protections and Alarms

- The remote computer will see the Dashboard related to this unit
- Check the "Status" portion of the Dashboard to see the status of the 8 types of protection / alarm warnings (See Section 13.3)
- Using "E-Mail Notify" Section of the Dashboard, selected protection / alarm warning(s) can be e-mailed to specified e-mail addressee.

11.10 INTERNAL DC SIDE FUSES

The following DC side fuses have been provided for internal protection of the DC input side:

- PSR-1200-24: 4 pieces of 20A fuses in parallel = 80A total. Each fuse: Mini Blade Fuse 32 VDC, 20A. Littell Fuse: 0297020.WXN or equivalent.
- PSR-1200-48: 4 pieces of 10A fuses in parallel = 40A total. Each fuse: Mini Blade Fuse 58 VDC, 10A. Littell Fuse: 0997010.WXN or equivalent.

11.11 REVERSE POLARITY AT THE DC INPUT TERMINALS

The Positive of the battery should be connected to the Positive DC input terminal of the inverter and the Negative of the battery should be connected to the Negative DC input terminal of the inverter. A reversal of polarity (the Positive of the battery wrongly connected to the Negative DC input terminal of the inverter and the Negative of the battery wrongly connected to the Positive DC input terminal of the inverter) will blow the external / internal DC side fuses. If the DC side fuse is blown, the Inverter will be dead. However, if AC GRID input is available, it will bypassed through with the following indications:

- LED marked "AC GRID" will be GREEN
- LED marked "INVERTER" will be OFF
- LED marked "BYPASS" will be GREEN
- LED marked "ALARM" will be OFF



INFO

Reverse polarity connection is likely to damage the DC input circuitry. The internal fuse(s) should be replaced with the same size of fuse(s) used in the unit. If the unit does not work after replacing the fuse(s), it has been permanently damaged and will require repair / replacement (Please read Section 11 - "Troubleshooting Guide" for more details).



CAUTION!

Damage caused by reverse polarity is not covered by warranty! When making battery connections on the input side, make sure that the polarity of battery connections is correct (Connect the Positive of the battery to the Positive terminal of the unit and the Negative of the battery to the Negative terminal of the unit). If the input is connected in reverse polarity, DC fuse(s) inside the Inverter / external fuse will blow and may also cause permanent damage to the Inverter.

SECTION 12 | Remote Parameter Monitoring & Setup Using USB / RS-232 Serial Communication Protocol

12.1 USB / RS-232 COMMUNICATION AND OPERATION

This unit uses a standard USB connector and a standard RS-232 COM Port.

The USB interface only supports Windows Platform (Windows Vista, Windows 7, Windows 8, Windows 8.1, Windows 10), which virtualizes a serial COM Port.

Both USB and RS-232 employ ASCII code to implement the asynchronous serial transmission control.

The byte structure is {START BIT} + {8 BIT DATA} + {STOP BIT}

12.2 RS-232 PORT

This unit uses a standard 9-pin D connector (Male) and three of the RS-232 signal lines:

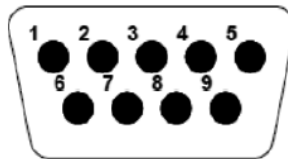

The connection between this unit and the computer is as follow:

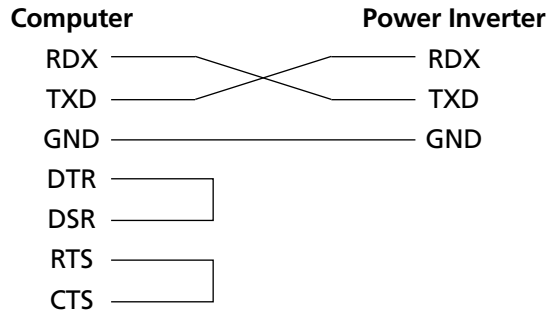

12.3 USB PORT

This unit uses a USB female single connector, and the power is supplied by external devices.



12.4 COMMUNICATION

A Terminal Emulator is required for the remote computer. For demonstration below, Terminal Emulator Software - " Tera Term " has been used (free download from the Internet).

SECTION 12 | Remote Parameter Monitoring & Setup Using USB / RS-232 Serial Communication Protocol

First, open Tera Term, and choose "Serial" and select corresponding COM Port:



Second, choose "Setup" -> "Terminal" to open "Terminal" dialog:

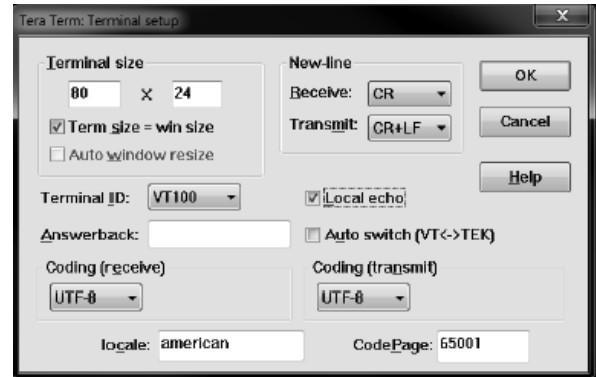

Set "CR+LF" for New-line Transmit, and check "Local echo".

Third, set Baudrate to the corresponding value.

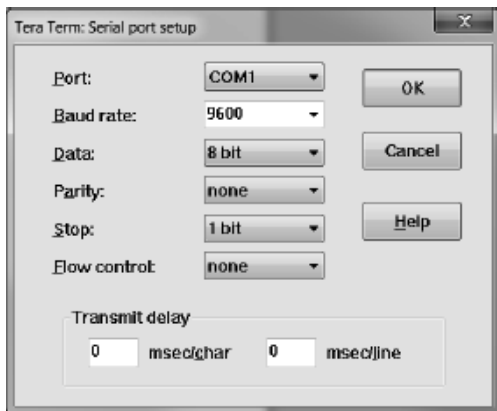

12.5 INTERFACE COMMAND

The buffer size used for communication is 30 bytes. This unit will ignore all bytes more than this value. During transmission, this unit will reply corresponding information to a computer according to the commands sent by the user.

When a LF character (ASCII code 0x0A) is received, this unit will begin to interpret the received information (case-sensitive) and execute the command, if it is valid.

When the unit receives an invalid command or fails to execute, the unit will reply "Invalid Command."

SECTION 12 | Remote Parameter Monitoring & Setup Using USB / RS-232 Serial Communication Protocol

12.6 COMMAND TABLE

Command Format	Command Example	Meaning	Possible Response
set/get forcefan on/off	set forcefan on	Turn on the unit's fan forcefully.	OK
	set forcefan off	Disable the function – "Turn on the unit's fan forcefully". Note: the unit's fan will be turned on/off according to the temperature or other condition automatically as necessary.	OK
	get forcefan	Return whether this function is enabled (ON).	off
get fan	get fan	Return whether the unit's fan is activated (Real-time Information).	on
get vin	get vin	Return DC input voltage (Realtime Information).	24.1 V
get vout	get vout	Return the RMS of the output voltage (Real-time Information).	120.1 V
get iout	get iout	Return the RMS of the output current (Real-time Information).	4.2 A
get power	get power	Return the output real power (Realtime Information).	980.1 W
get freq	get freq	Return the output frequency (Realtime Information).	60.0 Hz
get gvout	get gvout	Return the RMS of the Grid AC voltage (Real-time Information).	120.1 V
get giout	get giout	Return the RMS of the Grid AC current (Real-time Information).	4.2 A
get gpower	get gpower	Return the Grid AC real power (Real-time Information).	980.1 W
get gfreq	get gfreq	Return the Grid AC frequency (Real-time Information).	60.0 Hz
set/get cfgvout {n.f}	get cfgvout	Return the RMS of the output voltage setting.	120.0 V
	set cfgvout 105.5	Set the RMS of the output voltage setting to 105.5 V	OK
set/get cfgfreq {n.f}	get cfgfreq	Return the output frequency setting.	60.0 Hz
	set cfgfreq 55.2	Set the output frequency setting to 55.2 Hz	OK
get/set lcdcontrast {n}	get lcdcontrast	Return the LCD contrast setting.	50 %
	set lcdcontrast 50	Set the LCD contrast setting to 80 %.	OK
get/set lcdautooff {n}	get lcdautooff	Return the LCD back light auto-off delay time.	60 seconds
	set lcdautooff 120	Set the LCD back light auto-off delay time to 120 seconds.	OK
	set lcdautooff 0	Disable LCD back light auto-off function.	OK
get rs232speed / usbvcomspeed	get rs232speed	Return current RS-232 baudrate	4800 bps

SECTION 12 | Remote Parameter Monitoring & Setup Using USB / RS-232 Serial Communication Protocol

12.6 COMMAND TABLE (Continued)

Command Format	Command Example	Meaning	Possible Response
set rs232speed / usbvcomspeed {n}	set rs232speed 0	Set RS-232 baudrate to 1200 bps	OK
	set rs232speed 1	Set RS-232 baudrate to 2400 bps	OK
	set rs232speed 2	Set RS-232 baudrate to 4800 bps	OK
	set rs232speed 3	Set RS-232 baudrate to 9600 bps	OK
	set rs232speed 4	Set RS-232 baudrate to 14400 bps	OK
	set rs232speed 5	Set RS-232 baudrate to 19200 bps	OK
	set rs232speed 6	Set RS-232 baudrate to 24000 bps	OK
	set rs232speed 7	Set RS-232 baudrate to 28800 bps	OK
set/get buzfanfault on/off	get buzfanfault	Return whether the buzzer will "beep" when fan fault.	on
	set buzfanfault off	Buzzer will NOT "Beep" when fan fault.	OK
set/get buzovalarm on/off	get buzovalarm	Return whether the buzzer will "beep" when OV Alarm.	on
	set buzovalarm off	Buzzer will NOT "Beep" when OV Alarm.	OK
set/get buzuvalarm on/off	get buzuvalarm	Return whether the buzzer will "beep" when UV Alarm.	on
	set buzuvalarm off	Buzzer will NOT "Beep" when UV Alarm.	OK
set/get buzoverload on/off	get buzoverload	Return whether the buzzer will "beep" when overloading.	on
	set buzoverload off	Buzzer will NOT "Beep" when overloading.	OK
set/get buzovertemp on/off	get buzovertemp	Return whether the buzzer will "beep" when over temperature.	on
	set buzovertemp off	Buzzer will NOT "Beep" when over temperature.	OK
set/get buzshort on/off	get buzshort	Return whether the buzzer will "beep" when short circuit protection.	on
	set buzshort off	Buzzer will NOT "Beep" when short circuit protection.	OK
set/get relayfanfault on/off	get relayfanfault	Return whether the Dry Contact Relay will "close" when fan fault.	on
	set relayfanfault off	Dry Contact Relay will NOT "close" when fan fault.	OK
set/get relayovalarm on/off	get relayovalarm	Return whether the Dry Contact Relay will "close" when OV Alarm.	on
	set relayovalarm off	Dry Contact Relay will NOT "close" when OV Alarm.	OK
set/get relayuvalarm on/off	get relayuvalarm	Return whether the Dry Contact Relay will "close" when UV Alarm.	on
	set relayuvalarm off	Dry Contact Relay will NOT "close" when UV Alarm.	OK

SECTION 12 | Remote Parameter Monitoring & Setup Using USB / RS-232 Serial Communication Protocol

12.6 COMMAND TABLE (Continued)

Command Format	Command Example	Meaning	Possible Response
set/get relayoverload on/off	get relayoverload	Return whether the Dry Contact Relay will "close" when overloading.	on
	set relayoverload off	Dry Contact Relay will NOT "close" when overloading.	OK
set/get relayovertemp on/off	get relayovertemp	Return whether the Dry Contact Relay will "close" when over temperature.	on
	set relayovertemp off	Dry Contact Relay will NOT "close" when over temperature.	OK
set/get relaysshort on/off	get relaysshort	Return whether the Dry Contact Relay will "close" when short circuit.	on
	set relaysshort off	Dry Contact Relay will NOT "close" when short circuit protection.	OK
get/set invmode offline /online	get invmode	Get Inverter Mode.	offline
	set invmode offline	Set Inverter Mode to "offline".	OK
get/set trantype synch / unsynch	get trantype	Get Transfer Type.	synch
	set trantype synch	Set Transfer Type to "synch".	OK
get/set olprotect {n}	get olprotect	Get overload protection (percentage of full load).	110 %
	set olprotect 90	Set overload protection percentage to 90 %	OK
get relaystatus	get relaystatus	Get the current status of Bypass Relay.	Inverter
			Grid AC
get/set syncfreq {n.f}	get syncfreq	Get synchronization frequency.	7.0 Hz
	set syncfreq 5.5	Set synchronization frequency to 5.5 Hz	OK
get/set ovp {n.f}	get ovp	Get the OVP setting.	34.0 V
	set ovp 29.5	Set the OVP setting to 29.5 V	OK
get/set ovprecovery {n.f}	get ovprecovery	Get the OVP Recovery setting.	33.0 V
	set ovprecovery 29.5	Set the OVP Recovery setting to 29.5 V	OK
get/set uvp {n.f}	get uvp	Get the UVP setting.	20.0V
	set uvp 20.5	Set the UVP setting to 20.5 V	OK
get/set uvprecovery {n.f}	get uvprecovery	Get the UVP Recovery setting.	23.0 V
	set uvprecovery 22.5	Set the UVP Recovery setting to 22.5 V	OK
get/set ovalarm {n.f}	get ovalarm	Get the OV Alarm setting.	33.0 V
	set ovalarm 29.5	Set the OV Alarm setting to 29.5 V	OK
get/set uvalarm {n.f}	get uvalarm	Get the UV Alarm setting.	21.5 V
	set uvalarm 22.0	Set the UV Alarm setting to 22.0 V	OK

SECTION 12 | Remote Parameter Monitoring & Setup Using USB / RS-232 Serial Communication Protocol

12.6 COMMAND TABLE (Continued)

Command Format	Command Example	Meaning	Possible Response
get fanfault?	get fanfault?	Return current status of fan fault	normal
get ovalarm?	get ovalarm?	Return current status of Over Voltage Alarm	warning
get uvalarm?	get uvalarm?	Return current status of Under Voltage Alarm	normal
get overload?	get overload?	Return current status of overload	normal
get overtemp?	get overtemp?	Return current status of over temperature	warning
get ovp?	get ovp?	Return current status of Over Voltage Protection	normal
get uvp?	get uvp?	Return current status of Under Voltage Protection	normal
get short?	get short?	Return current status of Short Circuit Protection	normal
get ip	get ip	Return current IP of this unit.	192.168.1.10
get/set ipcfgip	get ipcfgip	Return current manually configured static IP of this unit.	192.168.1.100
	set ipcfgip 192.168.1.100	Configure static IP as 192.168.1.100	OK
get/set ipcfggateway	get ipcfggateway	Return manually configured Gateway IP	192.168.1.1
	set ipcfggateway 192.168.1.1	Configure Gateway IP as 192.168.1.1	OK
get/set ipcfgmask	get ipcfgmask	Return manually configured subnet mask	255.255.255.0
	set ipcfgmask 255.255.255.0	Configure subnet mask as 255.255.255.0	OK
get/set ipcfgpdns	get ipcfgpdns	Return manually configured Primary DNS Server IP	192.168.1.1
	set ipcfgpdns 192.168.1.1	Configure Primary DNS Server IP as 192.168.1.1	OK
get/set ipcfgsdns	get ipcfgsdns	Return manually configured Secondary DNS Server IP	192.168.1.1
	set ipcfgsdns 192.168.1.1	Configure Secondary DNS Server IP as 192.168.1.1	OK
get/set ipcfgdhcp	get ipcfgdhcp	Return DHCP status	on
	set ipcfgdhcp on	Turn on DHCP	OK
get/set ipcfgwebport	get ipcfgwebport	Return HTTP port number.	80
	set ipcfgwebport 600	Set HTTP port as 600	OK
set ipcfgsave on	set ipcfgsave on	Save and Update all IP Configures.	OK

SECTION 13 | Web Monitoring and SNMP

13. GENERAL

This unit supports WEB and SNMP (Simple Network Management Program) through Ethernet (IPv4).

13.1 INSTALLATION

13.1.2 For DHCP

1. Connect Ethernet cable to the Router
2. Connect Ethernet cable to the Ethernet port of this unit
3. Refer to the Menu Map for Programmable Operating Parameters at Section 10, Fig 10.1.

From any of the LED Operating Parameter Screens in the LCD Dashboard, press Down key ⏴ to go to the Main Menu, Parameter Group 1 – "UI Setting". Press Right key ⏴ 5 times to go to Parameter Group 6 – "Ethernet". Press the Down key ⏴ to go to Parameter "IP Address". Press Down key ⏴ again to access the IP Address Setup Screen.

4. A valid IP address of this unit would show up on the LCD Screen.
5. Enter the IP address from any device under the same network with a browser. (Ex: <http://192.168.0.10>)

13.1.2 For Static IP

Refer to the Menu Map for Programmable Operating Parameters at Fig 10.1, Section 10. From any of the LCD Operating Parameter Screens in the LCD Dashboard, press the Down key ⏴ to go the Main Menu for Parameter Group 1 – "UI Setting". Press Right key ⏴ 5 times to go to Parameter Group 6 – "Ethernet". Press the Down key ⏴ to go to Sub Menu for Parameter Group 6, Parameter (a) – "IP Address". Press right key ⏴ to go to Parameter (b) "IP Config". Press Down key ⏴ to go to the first parameter "IPCFG : DHCP" of 7 parameters in the Sub Sub Menu for Parameter Group "IP Config". Configure all the 7 available settings under this Sub Sub Menu for IP Configuration.

13.2 WEB MONITORING

Currently, WEB supports monitoring only. Values of programmable parameters can not be changed through this application.

13.2.1 Status Monitoring

Information being monitored is shown in the "Dashboard" at Fig 13.1. Items shown in the "Dashboard" at Fig 13.1 are further described in more details in Fig 13.2.

SECTION 13 | Web Monitoring and SNMP



samlexamerica®

Dash Board

SNMP Config

E-Mail Notify

Control

Admin

Version

Setup E-Mail Notification

A notification E-Mail will be sent when the specified warning(s) occur.

Only the characters below are allowed:
a-z , A-Z , 0-9 , ()*+,-./:;@[!^_`{}~

Empty User Name indicates No Authorization is needed.

Enable E-Mail Notification

SMTP Server:

SMTP Server Port:

Use TLS 1.1 Connection

TLS_RSA_WITH_AES_256_CBC_SHA

Login User:

Login Password:

Some SMTP servers require the users to enable
"Allow less secure apps" function for their account.
Thus, the E-Mail can be sent.

From:

To:

Subject:

User Message:

Timing

Repeat Count:

Repeat Interval :

Warning

Select warning(s)
that need to notify.

- Fan Fault
- Over Voltage Alarm
- Under Voltage Alarm
- Overload
- Over Temperature
- Short Circuit
- Over Voltage Protection
- Under Voltage Protection

Save Changes

* `Save Changes` first before sending a Test E-Mail
if you made any change.

Send Test E-Mail Now

Fig 13.1 Dashboard

SECTION 13 | Web Monitoring and SNMP

Name	Description
Device Info	
Product Name	Model of this product
Description	User defined in "Control" page
Location	User defined in "Control" page
MAC Address	MAC Address of this unit
System Up Time	Total time elapsed since turning on this unit
Temperature	
DC to DC	Temperature in Celsius sensed by NTC-1 near Heat Sink for DC-DC conversion MOSFETS
DC to AC	Temperature in Celsius sensed by NTC-2 near Heat Sink for DC-AC conversion IGBTs
Warning (Status)	
Fan Fault	(Green) Normal / (Red) Warning
Over Voltage Alarm	
Under Voltage Alarm	
Overload	
Over Temperature	
Over Voltage Protection	
Under Voltage Protection	
Short Circuit	
Output	
CFG. Voltage	Output voltage VAC (RMS) configured (programmed) by the user
Inv. Voltage	Real-Time output voltage VAC (RMS)
Grid. Voltage	Real-Time output voltage VAC (RMS)
Inv. Current	Real-Time output current A (RMS)
Grid. Current	Real-Time output current A (RMS)
Inv. Power	Real-Time output power (W)
Grid. Power	Real-Time output power (W)
CFG. Frequency	Output AC frequency (HZ) configured (programmed) by the user
Inv. Frequency	Real-Time output AC frequency (HZ)
Grid. Frequency	Real-Time output AC frequency (HZ)
Input	
Vin	Real-Time input DC voltage (V)
OVP	Over Voltage Protection (V) configured (programmed) by the user
OVP Recovery	OVP recovery voltage (V) configured (programmed) by the user
UVP	Under Voltage Protection (V) configured (programmed) by the user
UVP Recovery	UVP recovery voltage (V) configured (programmed) by the user
OV Alarm	Over Voltage Alarm (V) configured (programmed) by the user
UV Alarm	Under Voltage Alarm (V) configured (programmed) by the user
Status	
Fan	on / off
Bypass Relay	Inverter / Grid AC
Bypass Mode	On-Line / Off-Line
Grid AC	Not exists / detect / Present / Sync / Won't Sync
OL. Percentage	Overload percentage configured (programmed) by the user
Sync. Frequency	Synchronization Frequency Window configured
User Interface	
LCD Contrast	LCD contrast configured by the user
LCD Auto-Off	LCD backlight auto-off time configured (programmed) by the user
RS-232 Speed	RS-232 COM Port Baudrate configured (programmed) by the user
USB Virtual COM	USB Virtual COM Baudrate configured (programmed) by the user
User Interface	
Buzzer Setup	(Green) ON / (Red) OFF configured (programmed) by the user
Dry Contact Setup	

Fig 13.2 Description of Items displayed in Dashboard at Fig 13.1

SECTION 13 | Web Monitoring and SNMP

13.2.1.1 Power Monitoring

Power Monitoring (Fig 13.3) displays the output power versus time.

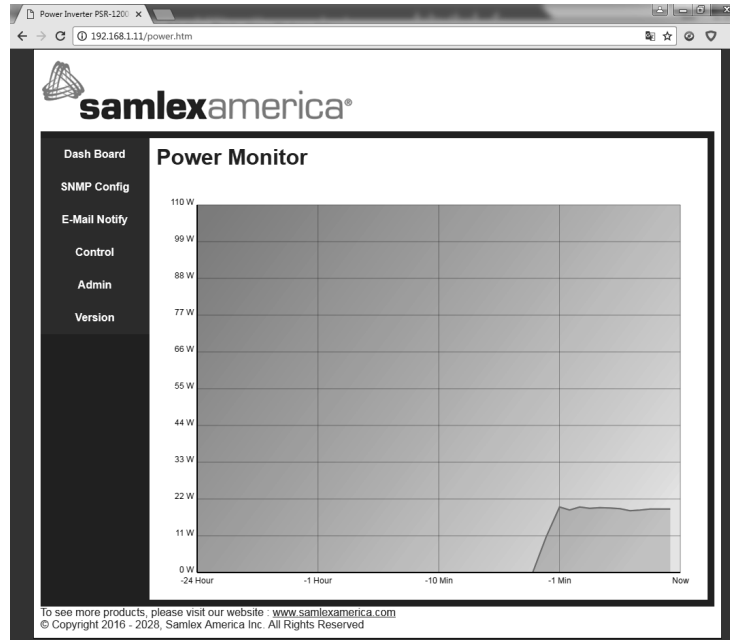

Fig 13.3 Description of Items displayed in Dashboard at Fig 13.1

13.2.1.2 DC Input Voltage (Vin) Monitoring

DC Input Voltage (Vin) Monitor (Fig 13.4) displays the DC input voltage versus time.

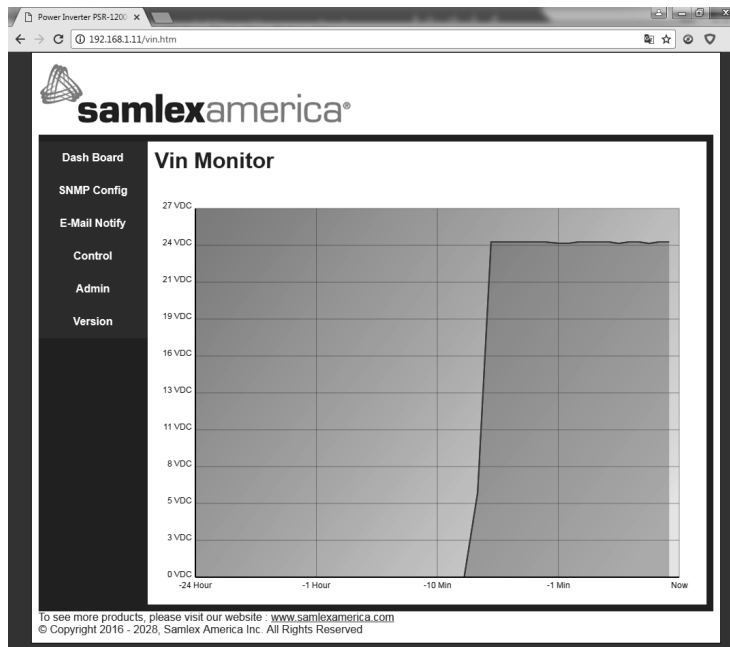

Fig 13.4 DC Input Voltage (Vin) Monitor

SECTION 13 | Web Monitoring and SNMP

13.2.2 Creating Nickname for the unit

Page shown in Fig 13.5 would first pop up an authorization dialog before accessing the content, which is Password-Based.

The values in the "Description" / "Location" (Fig 13.1) fields will be shown on the Dash Board as "Description" / "Location", and also be sent by SNMP response.

13.2.3 Change Password and User Name

Change Password and User Name page (Fig 13.6) would first pop up an authorization dialog before accessing the content, which is Password-Based.

The user needs to use the new "User Name" and "Password" to access "SNMP Config", "Control" and "Admin" pages after changing the admin account setting.

13.2.4 Reset Password

Password is reset using programming facility available through the LCD Display on the unit.

1. Refer to Menu Map for Programmable Operating Parameters at Fig 10.1 in Section 10. From any of the LCD Operating Parameter Screens in the Dashboard, press the Down key \downarrow to go to the Main Menu screen for Parameter Group 1 – "UI Settings". Press Right key \rightarrow 5 times to go to Main Menu Screen for Parameter Group 6 – "Ethernet". Press the Down key \downarrow to go to the Sub Menu for Parameter Group 6, Parameter (a) – "IP Address". Press the Right key \rightarrow 2 times to go to Parameter (c) – "RST Password". Press Down key \downarrow to go to the Setup Screen for "RST Password". Press the Right key \rightarrow to complete reset action.

2. The default User Name is "admin" and the default Password is "0000".

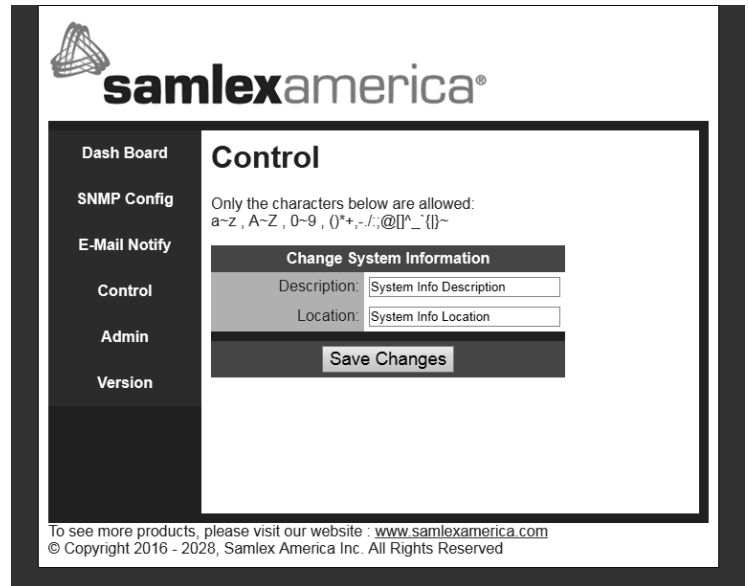

Fig 13.5 Creating nickname for the unit

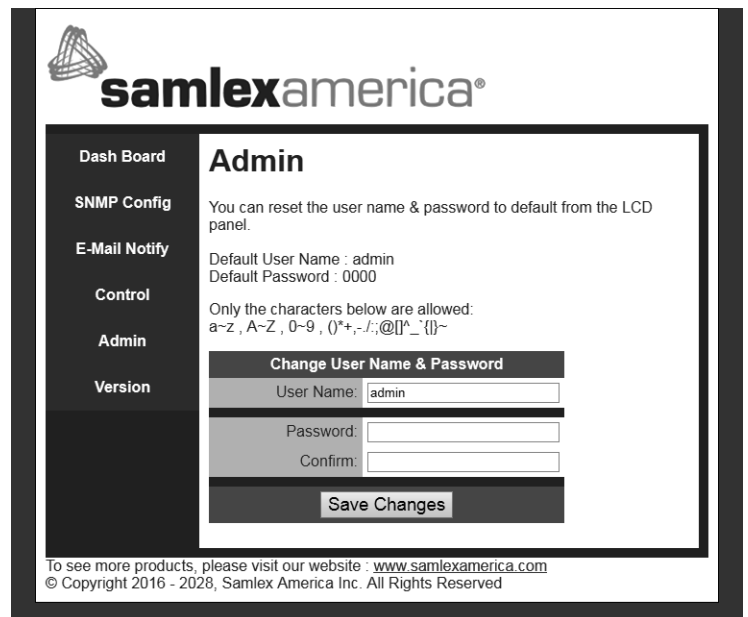

Fig 13.6 Page for changing User Name and Password

SECTION 13 | Web Monitoring and SNMP

13.3 E-MAIL NOTIFICATION

Refer to Fig 13.7 for Page for E-mail Notification.

This page provides an interface for users to setup E-mail related settings. A notification E-mail will be sent when the selected warning(s) occur.

13.3.1 Enable E-Mail Notification

Check this box to enable this feature.

13.3.2 SMTP Server & SMTP Port

Users must provide the SMTP Server & SMTP Port they would like to use, like the way setting up E-Mail accounts in Microsoft Outlook.

Ex: GMail (smtp.gmail.com), Yahoo (smtp.mail.yahoo.com)

13.3.3 Login User & Login Password

Users need to provide login user name and login password for the authentication by SMTP Server, or leave "Login User" field empty to skip the authentication process if SMTP Server do not require one.

Some SMTP servers require "Transport Layer Security". Thus, the box, "Use TLS 1.1 Connection", should be checked.

13.3.4 From & To

The user's E-Mail addresses are required. (Sending an E-Mail to oneself is OK)

13.3.5 Timing

13.3.5.1 Repeat Count

The E-Mail will be sent (Count+1) times when the specified warning(s) occur continuously and are NOT dismissed. ("No repeat" indicates only ONE E-Mail will be sent)

13.3.5.2 Repeat Interval

The E-Mail will be sent again after (Interval) if the warning(s) were NOT dismissed.

13.3.6 Warning

Select the warning(s) that will trigger an E-Mail notification.

13.3.7 Send Test E-Mail Now

After finishing configuring, the user should do a test whether this unit can send an E-Mail on behalf of the user's account on the specified SMTP Server.

Fig 13.7 Page for setting up E-mail notification

SECTION 13 | Web Monitoring and SNMP

13.4 SNMP

This unit supports SNMP v1, v2c.

13.4.1 SNMP Community Configuration

Community Configuration Page (Fig 13.8) would first pop up an authorization dialog before accessing the content, which is Password-Based. You can change a few settings of SNMP from this page.

samlexamerica®

SNMP Community Configuration

Read/Write Community String configuration for SNMPv2c Agent.

Configure multiple community names if you want the SNMP agent to respond to the NMS/SNMP manager with different read and write community names. If less than three communities are needed, leave extra fields blank to disable them.

Only the characters below are allowed:
a~z , A~Z , 0~9 , ()*+,-./:;@[!^_`{}~

Enable SNMP

Read Community

Community 1 : public

Community 2 : read

Community 3 :

Write Community

Community 1 : private

Community 2 : write

Community 3 : public

Trap Setup

Enable Trap 1

IP Address: [Broadcast: 0.0.0.0]
192.168.1.10

Community Name:
public

Enable Trap 2

IP Address: [Broadcast: 0.0.0.0]
0.0.0.0

Community Name:
private

Trap Interval : 5 seconds

Save Changes

Fig 13.8 SNMP Community Configuration

13.4.1.1 Enable SNMP

Check this box to enable the whole functionality of SNMP.

13.4.1.2 Read / Write Community

This is more like a Password-Based communication mechanism between SNMP Agent (This unit) and SNMP Manager (A management software on a specific computer under the same network).

13.4.1.3 Trap Setup

Check "Enable Trap 1" or "Enable Trap 2" to enable the functionality of SNMP Trap. The IP Address fields should be the IP address of the SNMP Manager under the same network.

SECTION 13 | Web Monitoring and SNMP

13.4.1.4 Trap Interval

Select the time interval between repeated TRAPs. If any abnormal condition continues, a TRAP will be sent by SNMP agent repeatedly till the condition is dismissed.

13.4.2 TRAP

TRAP is an active message sent by SNMP agent (This unit) whenever an abnormal situation is encountered (Ex. UVP, OVP, OVERLOAD...etc). This message will be sent to SNMP Manager specified by "Trap Setup" mentioned before.

13.4.3 SNMP Demonstration

There are several SNMP manager software (Free version / Paid version) over the Internet. For demonstration "PowerSNMP Free Manager" (Free version), has been used. This has been downloaded from <http://www.dart.com/snmp-free-manager.aspx>.

Demonstration is shown below:

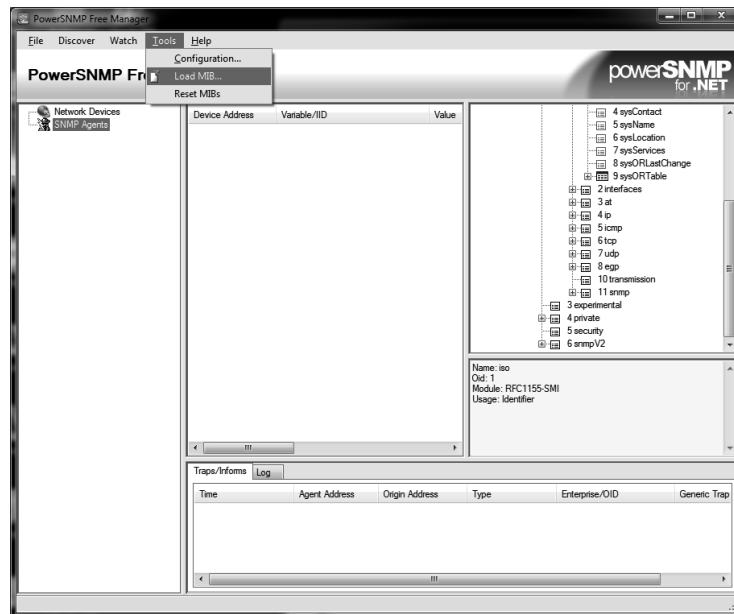

Fig 13.9 Demonstration Screen 1 for SNMP

First, select "Tools" -> "LoadMIB..." to import the file - "samlexamerica.mib" (Fig 13.9).

The file - "samlexamerica.mib" is a text file, which can be opened by any text editor such as Notepad. And it is more like a dictionary to translate SNMP OID (Object Identifier) into nature language.

On the right panel, we have a node - "49075 samlexamerica" (OID : 1.3.6.1.4.1.49075) in SNMP tree.

The file - "samlexamerica.mib" is a text file, which can be opened by any text editor such as Notepad. And it is more like a dictionary to translate SNMP OID (Object Identifier) into nature language.

On the right panel, we have a node - "49075 samlexamerica" (OID : 1.3.6.1.4.1.49075) in SNMP tree (See Fig 13.10).

SECTION 13 | Web Monitoring and SNMP

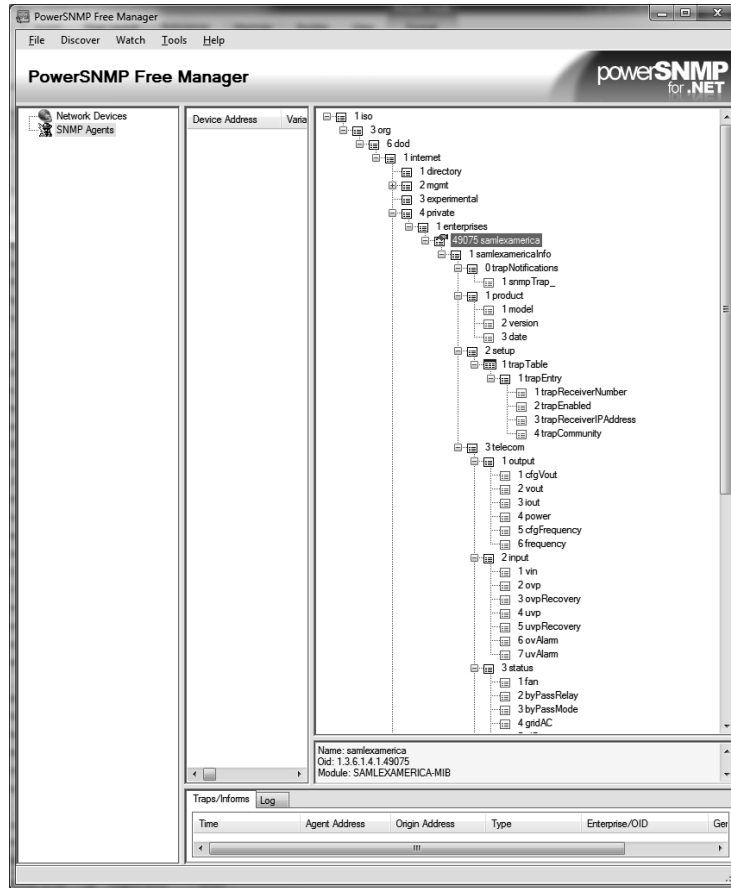

Fig 13.10 Demonstration Screen 2 for SNMP

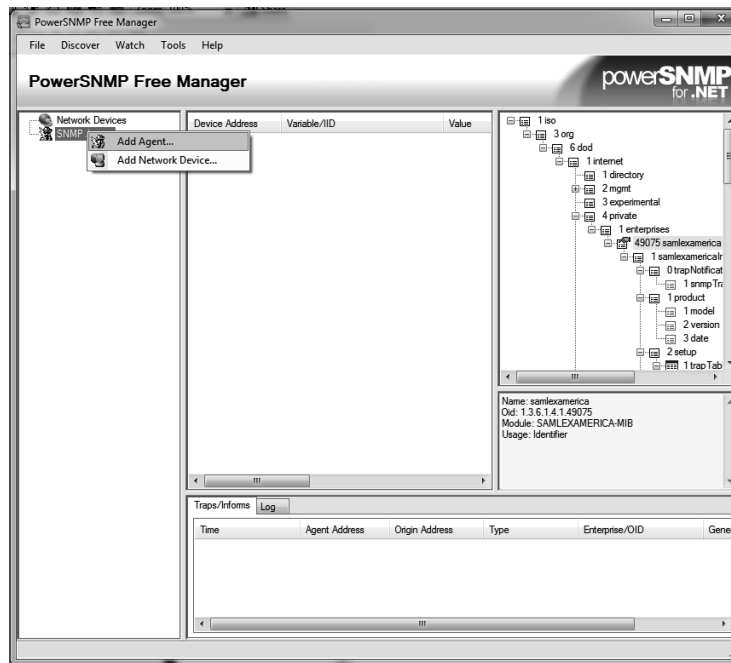

Fig 13.11 Demonstration Screen 3 for SNMP

SECTION 13 | Web Monitoring and SNMP

Right click "SNMP Agents", and select "Add Agent..." in the popup menu (Fig 13.11).

Click "Add Agent..." on the left-bottom corner of "Add SNMP Agents" dialog (Fig 13.12).

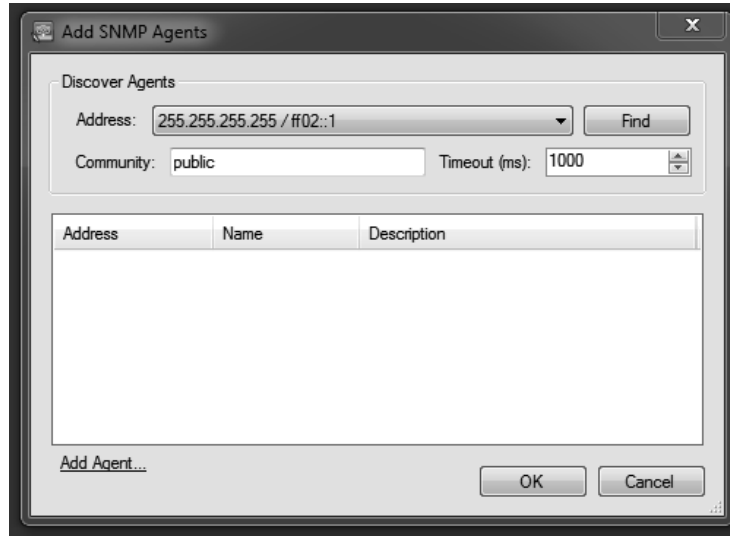

Fig 13.12 Demonstration Screen 4 for SNMP

Enter the IP address of this unit in the Address field, and choose "Version 2" (Fig 13.13).

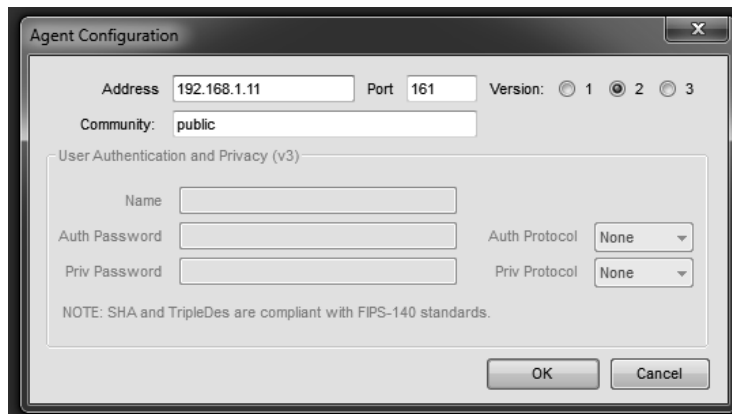

Fig 13.13 Demonstration Screen 5 for SNMP

Press "OK" (Fig 3.13). Now, we have an agent (this unit) on the left panel (Fig 3.14).

SECTION 13 | Web Monitoring and SNMP

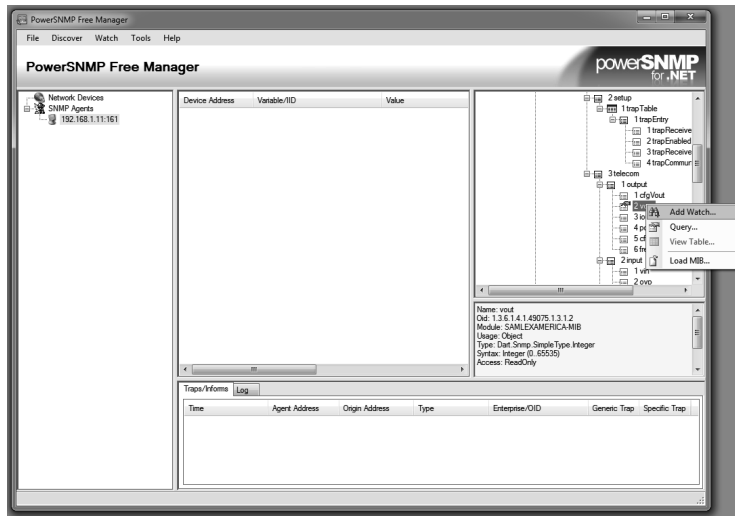

Fig 13.14 Demonstration Screen 6 for SNMP

Right click on any node in the right panel, and select “Add Watch...” (Fig 13.14), and the value we want to monitor would appear on the center panel (Fig 13.15).

Whenever an abnormal situation is encountered, a TRAP message is sent from the agent (this unit) every N seconds (Configured in SNMP Config page) if the situation continue. The following picture shows the TRAP message received by the SNMP Manager.

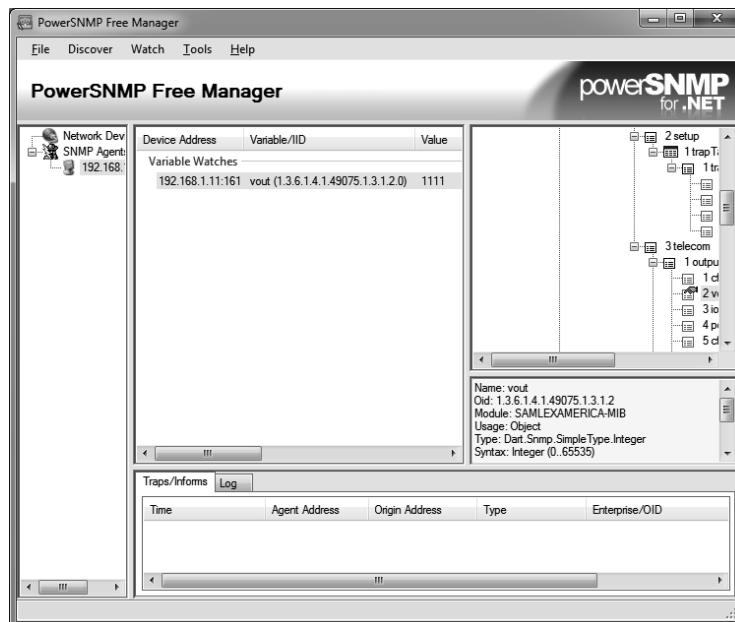

Fig 13.15 Demonstration Screen 7 for SNMP

SECTION 13 | Web Monitoring and SNMP

Whenever an abnormal situation is encountered, a TRAP message is sent from the agent (this unit) every N seconds (Configured in SNMP Config page) if the situation continues. The following picture (Fig 13.16) shows the TRAP message received by the SNMP Manager.

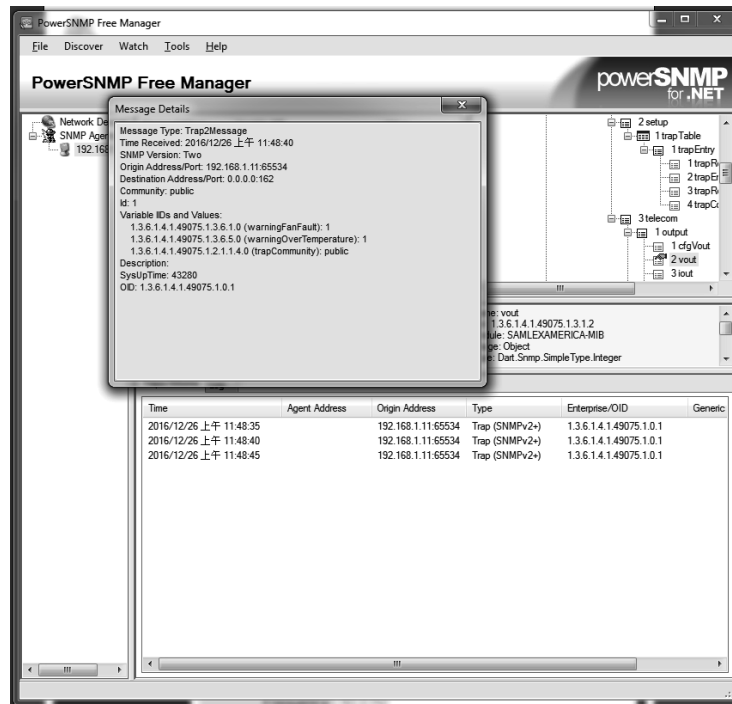

Fig 13.16 Demonstration Screen 8 for SNMP

The TRAP message will appear on the bottom panel (Fig 13.16), and double-click on the list (Fig 13.16) will popup a detail version the TRAP message selected. In the example in the above picture (Fig 13.16), a "FanFault" and a "OverTemperature" situation are encountered.



SECTION 14 | Firmware Upgrade / Backup

14. FIRMWARE UPGRADE / BACKUP

Firmware upgrade / backup is carried out using computer terminal that is connected to the unit through the USB / RS-232 Serial Communication Port. The computer terminal will require Terminal Emulator Software. For demonstration below, Terminal Emulator Software "Tera Term" has been used (free download from the Internet).

14.1 FIRMWARE OPERATION MODE

Be aware to keep the DC input (Battery) stable.

To enter "Firmware Operation Mode", press  and  simultaneously while turning ON the unit (At least 0.1 s). "Firmware OP Mode" will be shown on the LCD panel. Then, connect RS-232 or USB Virtual COM to the computer.

Set Serial COM Port Baudrate to 76800 bps (Fig 14.1), and uncheck "Local echo" (Fig 14.2).

Press "Enter". Content as shown in Fig 14.3 will be displayed on the Terminal.



Fig 14.1 Demonstration Screen 1 for Upgrade

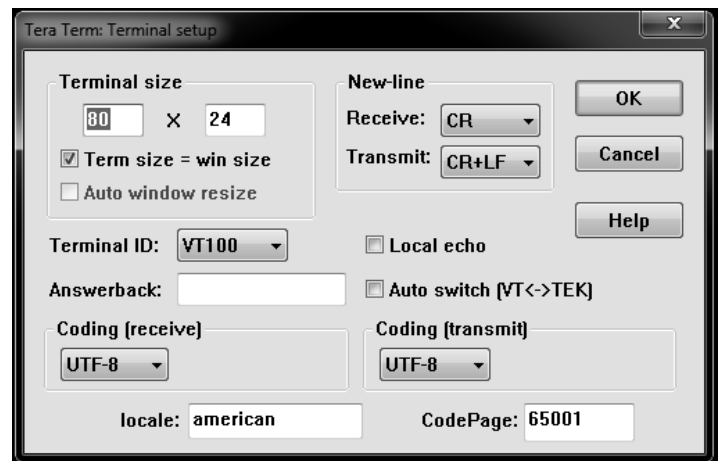

Fig 14.2 Demonstration Screen 2 for Upgrade

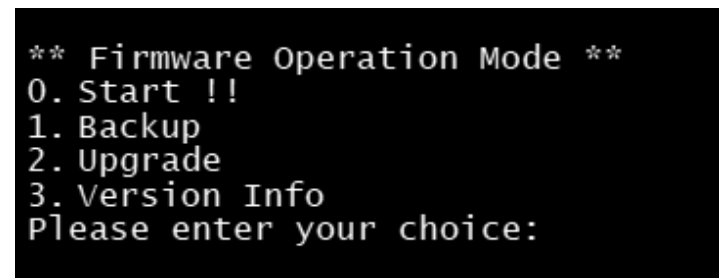

Fig 14.3 Demonstration Screen 4 for Firmware Upgrade

SECTION 14 | Firmware Upgrade / Backup

14.1.1 Menu Hierarchy

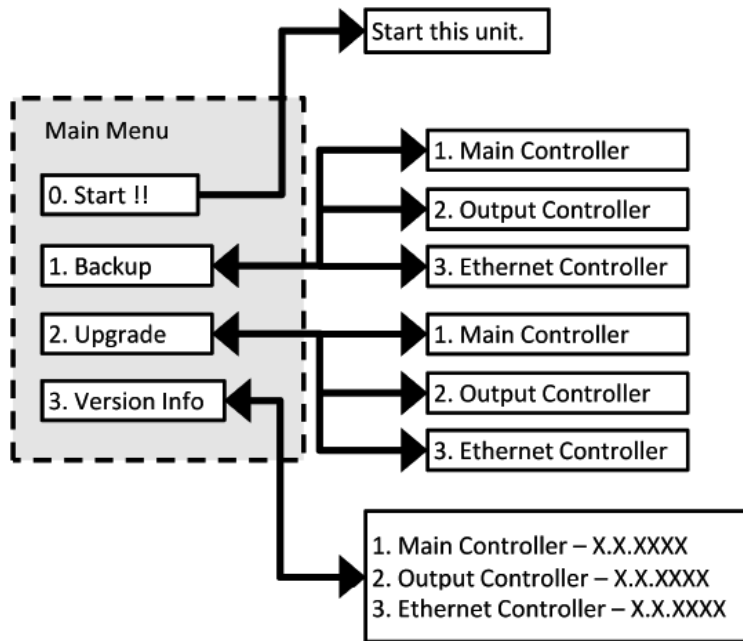

Fig 14.4 Menu Hierarchy

14.2 UPGRADE

Type "2" (Upgrade) from the Main Menu (Fig 14.3) and then press "Enter" to enter "Upgrade" sub-menu (Fig 14.5). Select a target to upgrade. In the example below (Fig 14.5), Serial 1. Main Controller has been selected. You will be asked to confirm the selection (Fig 14.6) and then, the existing version will be erased from the memory to enable upgrade to the new version (See Fig 14.7).

```
** Firmware Upgrade **  
1. Main Controller  
2. Output Controller  
3. Ethernet Controller  
Please select a target:
```

Fig 14.5 Demonstration Screen 5 for Firmware Upgrade

```
** Firmware Upgrade for Main Controller **  
Please enter "12345678" to confirm:
```

Fig 14.6 Demonstration Screen 6 for Firmware Upgrade

```
Erasing program memory...  
Done !!  
Please upload firmware now [94 KB (96256 bytes)] >>
```

Fig 14.7 Demonstration Screen 7 for Firmware Upgrade

SECTION 14 | Firmware Upgrade / Backup

Using Terra Terminal File Menu, select "Send file" option (See Fig 14.8). Select the folder in the computer where the Binary file is located and press "Open" (Fig 14.9). Upload will be carried out (See Fig 14.10).

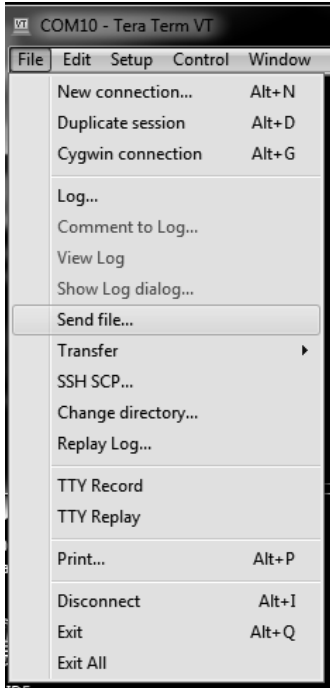

Fig 14.8 Demonstration Screen 8 for Firmware Upgrade

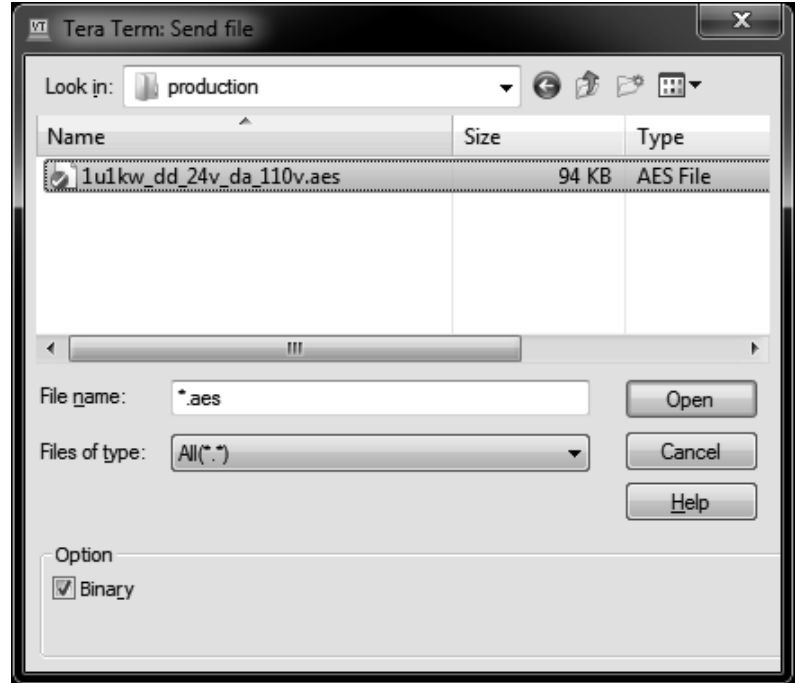

Fig 14.9 Demonstration Screen 9 for Firmware Upgrade

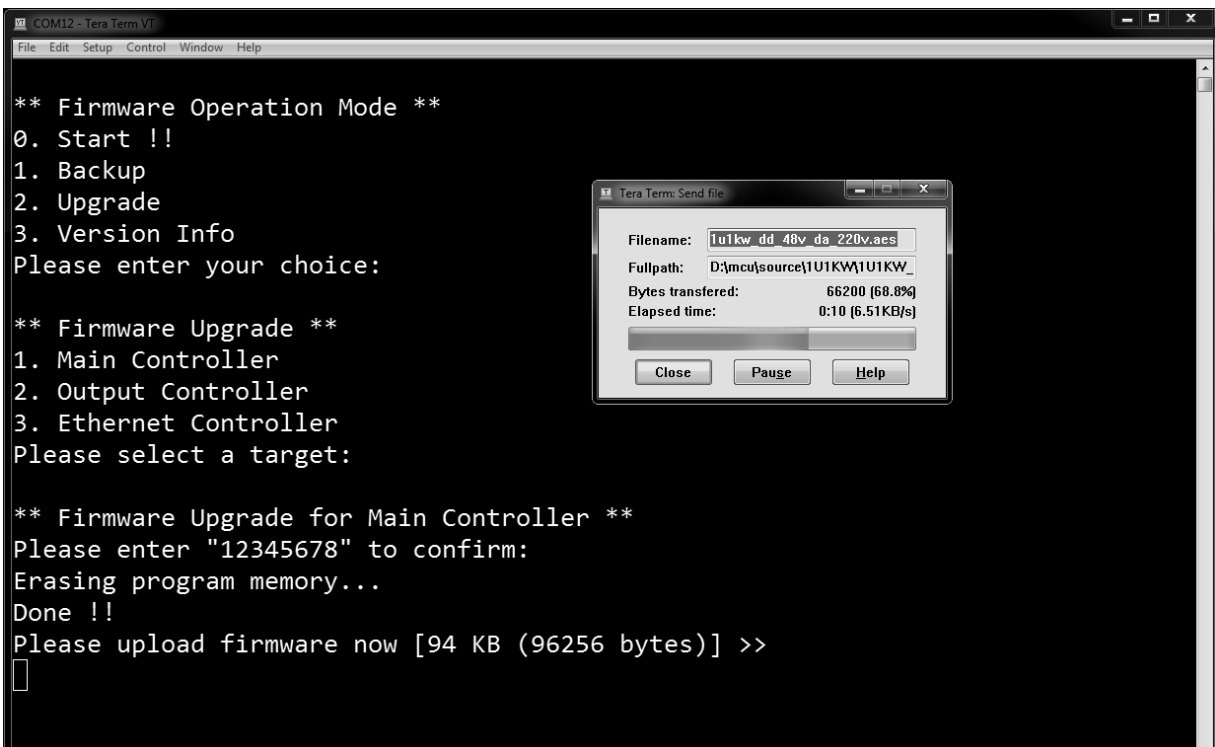

Fig 14.10 Demonstration Screen 10 for Firmware Upgrade

SECTION 14 | Firmware Upgrade / Backup

14.3 BACKUP

A terminal Emulator Software will be required. For demonstration below, Terminal Emulator "Real Term" has been used (free download from the internet <http://realterm.sourceforge.io/space>. Switch to Port tab, and select corresponding Port, and set baud-rate to 76800 bps (Fig 14.11).

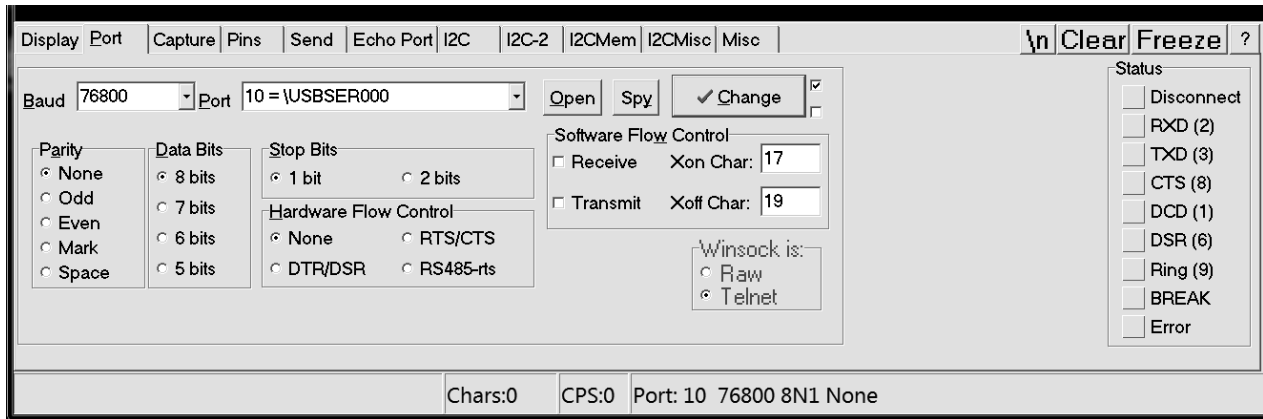

Fig 14.11 Demonstration Screen 1 for Backup

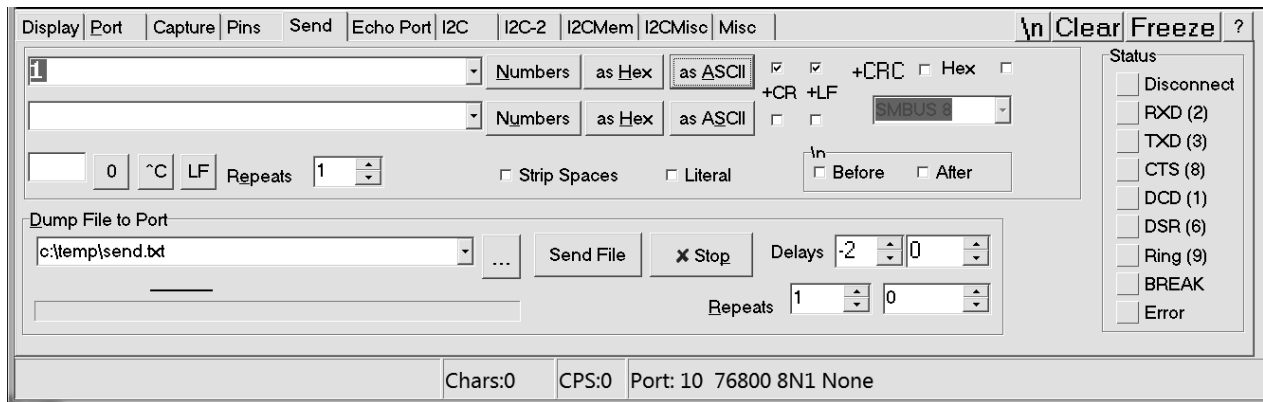

Fig 14.12 Demonstration Screen 2 for Backup

Switch to Send Tab, and check +CR and +LR (Fig 14.12. And then type "1" in the input box and click "as ASCII" (Fig 14.12) to send the command in main menu to enter "Backup" Sub Menu (Fig 14.13).

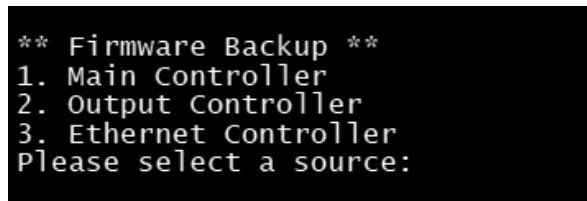

Fig 14.13 Demonstration Screen 3 for Backup

SECTION 14 | Firmware Upgrade / Backup

In this example, source of backup is "1". Main Controller". Enter 1 to select this source. Sub Menu "Firmware Backup for Main Controller" is now displayed (Fig 14.14).

To be prepared to log the incoming binary data, switch to "Capture" tab, and set the output file and "End After" field to file size (96256) [Fig 14.15].

```
** Firmware Backup for Main Controller **
Step 1. Please be prepared to log incoming binary data [94 KB (96256 bytes)].
Step 2. Stop logging when the transmission is stopped.
Step 3. Press Enter after stopping logging.
y=start transmission, other=cancel >>
```

Fig 14.14 Demonstration Screen 4 for Backup

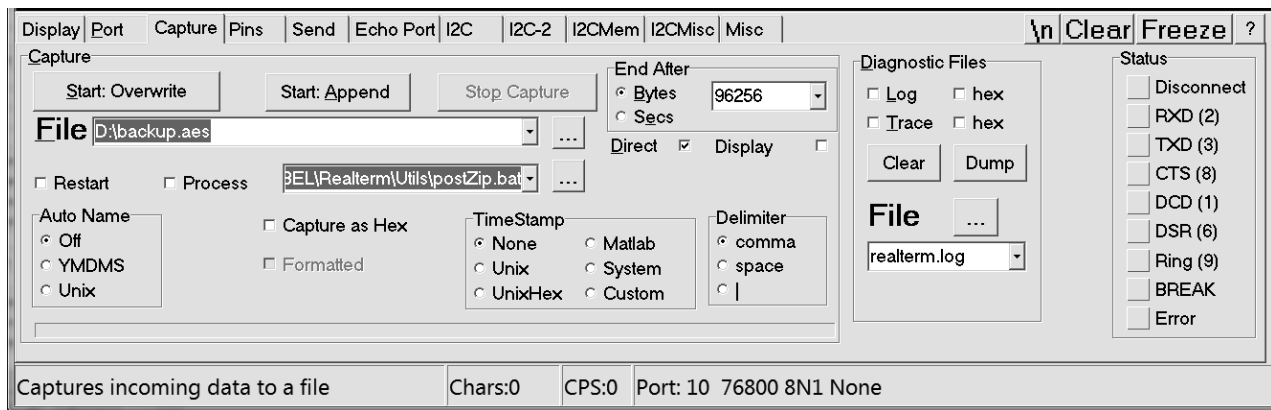

Fig 14.15 Demonstration Screen 5 for Backup

Click "Start: Overwrite", and switch back to "Send" Tab (Fig 14.15).

Send "y" (Fig 14.14) to trigger the transmission.

SECTION 15 | Specifications

MODEL NO.	PSR-1200-24	PSR-1200-48
AC OUTPUT IN INVERTER MODE		
OUTPUT VOLTAGE	100 - 120 VAC (User selectable) ; Default: 120 VAC	
OUTPUT FREQUENCY	45 - 65 Hz (User Selectable) ; Default: 60Hz	
TYPE & OUTPUT WAVE FORM	High Frequency Type ; Pure Sine Wave	
TOTAL HARMONIC DISTORTION (THD) OF OUTPUT WAVEFORM	< 2%	
CONTINUOUS OUTPUT POWER	1200W	
SURGE OUTPUT POWER	2000W	
PEAK EFFICIENCY	> 88%	> 90%
NEUTRAL ISOLATION	<ul style="list-style-type: none"> • Neutral bonded to Chassis Ground when Inverter is supplying the load • Neutral isolated from Chassis Ground when Grid is supplying the load 	
AC OUTPUT IN BYPASS MODE		
OUTPUT VOLTAGE	Same as external AC input source	
TYPE OF OUTPUT WAVE FORM	Same as external AC input source	
THD OF OUTPUT WAVEFORM	Same as external AC input source	
CONTINUOUS OUTPUT POWER	1200W continuous (Protected by 15A AC input breaker)	
RATING OF TRANSFER RELAY	16A	
TRANSFER RELAY SWITCHING TIME	< 8ms	
TRANSFER TYPE	Synchronized or Unsynchronized (User selectable)	
NEUTRAL ISOLATION	Neutral and Chassis Ground are isolated through internal relay	
DC/AC INPUT		
NOMINAL DC INPUT VOLTAGE	24 VDC	48 VDC
DC INPUT VOLTAGE RANGE	20 - 34 VDC	40 - 60 VDC
DC INPUT NO LOAD CURRENT	< 0.6A	< 0.5A
AC INPUT FROM GRID/GENERATOR	100 - 120 VAC, 50/60 Hz	
DISPLAY		
LCD	Alphanumeric: 2 lines x 16 characters each	
LEDS	4 LEDS: AC GRID ; INVERTER ; BYPASS ; ALARM	
LOCAL CONTROL & MONITORING		
MODE AND PARAMETER SETUP	Through Menus displayed on the LCD screen	
MONITORING OPERATING STATUS	Through LCD screen and 4 LEDS	
REMOTE CONTROL AND MONITORING		
PARAMETER SETUP AND MONITORING USING USB / RS-232	Through computer screen using ACII coded commands	
MONITORING USING ETHERNET/SNMP	Through computer's Web Browser and Ethernet connection <ul style="list-style-type: none"> • E-mail notification of faults and alarms Notification of faults and alarms through Ethernet / SNMP Trap Messaging	
WIRED ON/OFF CONTROL THROUGH TERMINALS MARKED ENB, ENB AND GND	To switch ON: <ul style="list-style-type: none"> • External + 10 to 40VDC fed to ENB and GND (< 6mA) • Short ENB and GND • Battery Positive fed to ENB 	To switch ON: <ul style="list-style-type: none"> • External + 20 to 60VDC fed to ENB and GND (< 6mA) • Short ENB and GND • Battery Positive fed to ENB
WIRED SIGNALLING	Signaling of faults and alarms through SPDT relay contact switching (no voltage) <ul style="list-style-type: none"> • Relay contact rating: 240 VAC, 16A 	
PROTECTIONS		
COOLING	Three load / temperature controlled fans: <ul style="list-style-type: none"> • Switch ON when output load is >300W and switch OFF when the load reduces to < 280W • Switch ON when internal heat sink temperature is $\geq 50^{\circ}\text{C}$ and switch OFF when temperature reduces to $\leq 45^{\circ}\text{C}$ 	
DC INPUT UNDER VOLTAGE (UV) ALARM	17.0 to 23.0 VDC ; Default: 21.5 VDC (Auto reset at 0.5V > the set voltage)	34.0 to 46.0 VDC ; Default: 43.0 VDC (Auto reset at 1.0V > the set voltage)
DC INPUT OVER VOLTAGE (OV) ALARM	25.0 to 35.0VDC ; Default: 33.0VDC (Auto reset at 0.5V < the set voltage)	50.0 to 62.0 VDC ; Default: 56.0 VDC (Auto reset at 1.0V < the set voltage)

SECTION 15 | Specifications

MODEL NO.	PSR-1200-24	PSR-1200-48
PROTECTIONS (Cont'd)		
FAN FAULT ALARM	Fan stops	Fan stops
DC INPUT UNDER VOLTAGE PROTECTION (UVP)	17.0 to 23.0 VDC ; Default: 20.0 VDC	34.0 to 46.0 VDC ; Default: 40.0 VDC
DC INPUT UNDER VOLTAGE PROTECTION (UVP) RECOVERY	17.5 to 23.5 VDC ; Default: 23.0 VDC	35.0 to 47.0 VDC ; Default: 46.0 VDC
DC INPUT OVER VOLTAGE PROTECTION (OVP)	25.0 to 35.0 VDC ; Default: 34.0 VDC	50.0 to 62.0 VDC ; Default: 60.0 VDC
DC INPUT OVER VOLTAGE PROTECTION (OVP) RECOVERY	24.5 to 34.5 VDC ; Default: 33.0 VDC	49.0 to 61.0 VDC ; Default: 58.0 VDC
OUTPUT OVERLOAD (OL) PROTECTION	<ul style="list-style-type: none"> • Programmable from 100% to 110% • Default: 110% • Shut down when load is > programmed value for > 2 sec 	
SHORT CIRCUIT PROTECTION	Shut down in case of the following: <ul style="list-style-type: none"> • Output voltage is < 80V RMS for 1.2 sec • Output current is > 24A for 1.2 sec 	
OVER TEMPERATURE PROTECTION	Shut down when internal heat sink temperature is >105°C. Auto reset at 85°C.	
DC INPUT OVER CURRENT PROTECTION	4 pieces of 20A fuses in parallel = 80A Each fuse: Mini Blade Fuse, 20A: Littell Fuse 0297020.WXN or equivalent	4 pieces of 10A fuses in parallel = 40A Each fuse: Mini Blade Fuse, 10A: Littell Fuse 0997010.WXN or equivalent
AC INPUT OVER CURRENT PROTECTION	Breaker, 250 VAC, 15A	
INPUT /OUTPUT CONNECTIONS		
DC INPUT	Terminals with cylindrical hole and set screw <ul style="list-style-type: none"> • Hole diameter: 7/16" • Set screw: 5/16" x 24 TPI; ½" length; Slotted head 	
DC CHASSIS GROUND	Terminal with cylindrical hole and set screw <ul style="list-style-type: none"> • Hole diameter: 5/16" • Set screw: 5/16" x 24 TPI; 3/8" length; Slotted head 	
AC INPUT CONNECTION	<ul style="list-style-type: none"> • Male AC Power Inlet Connector IEC 60320, C14 • Detachable AC Power Cord with mating Connector IEC 60320, C13 on one end and NEMA5-15P Plug on the other end (Supplied with the unit) 	
AC OUTPUT CONNECTION	NEMA5-20R Duplex Outlet	
SAFETY AND EMI/EMC COMPLIANCE		
SAFETY	ETL listed to UL Standard 62368-1 and CSA Standard C22.2 No. 62368-1	
EMI/EMC	Certified to comply with FCC Part 15(B), Class B	
ENVIRONMENT		
OPERATING TEMPERATURE RANGE	-20 to +50°C	
RELATIVE HUMIDITY	Up to 90%, non condensing	
STORAGE TEMPERATURE	-30 to +70°C	
DIMENSIONS		
(W X D X H), MM / INCHES	482 X 386.8 X 44 / 19X 15.24 X 1.73	
WEIGHT		
KG / LB	5.8 / 12.8	

NOTES:

1. All AC power ratings in the Inverter Section are specified at Power Factor = 0.95
2. All specifications given above are at ambient temperature of 25°C / 77°F unless specified otherwise
3. Specifications are subject to change without notice

SECTION 16 | Warranty

2 YEAR LIMITED WARRANTY

PSR-1200-24 and PSR-1200-48 are manufactured by Samlex America, Inc. (the "Warrantor") is warranted to be free from defects in workmanship and materials under normal use and service. The warranty period is 2 years for the United States and Canada, and is in effect from the date of purchase by the user (the "Purchaser").

Warranty outside of the United States and Canada is limited to 6 months. For a warranty claim, the Purchaser should contact the place of purchase to obtain a Return Authorization Number.

The defective part or unit should be returned at the Purchaser's expense to the authorized location. A written statement describing the nature of the defect, the date of purchase, the place of purchase, and the Purchaser's name, address and telephone number should also be included.

If upon the Warrantor's examination, the defect proves to be the result of defective material or workmanship, the equipment will be repaired or replaced at the Warrantor's option without charge, and returned to the Purchaser at the Warrantor's expense. (Contiguous US and Canada only)

No refund of the purchase price will be granted to the Purchaser, unless the Warrantor is unable to remedy the defect after having a reasonable number of opportunities to do so. Warranty service shall be performed only by the Warrantor. Any attempt to remedy the defect by anyone other than the Warrantor shall render this warranty void. There shall be no warranty for defects or damages caused by faulty installation or hook-up, abuse or misuse of the equipment including exposure to excessive heat, salt or fresh water spray, or water immersion.

No other express warranty is hereby given and there are no warranties which extend beyond those described herein. This warranty is expressly in lieu of any other expressed or implied warranties, including any implied warranty of merchantability, fitness for the ordinary purposes for which such goods are used, or fitness for a particular purpose, or any other obligations on the part of the Warrantor or its employees and representatives.

There shall be no responsibility or liability whatsoever on the part of the Warrantor or its employees and representatives for injury to any persons, or damage to person or persons, or damage to property, or loss of income or profit, or any other consequential or resulting damage which may be claimed to have been incurred through the use or sale of the equipment, including any possible failure of malfunction of the equipment, or part thereof. The Warrantor assumes no liability for incidental or consequential damages of any kind.

Samlex America Inc. (the "Warrantor")
www.samlexamerica.com

Contact Information

Toll Free Numbers

Ph: 1 800 561 5885

Fax: 1 888 814 5210

Local Numbers

Ph: 604 525 3836

Fax: 604 525 5221

Website

www.samlexamerica.com

USA Shipping Warehouses

Kent, WA

Plymouth, MI

Canadian Shipping Warehouse

Delta, BC

Email purchase orders to
orders@samlexamerica.com

